



US00D482820S

(12) **United States Design Patent**
Minami

(10) **Patent No.:** **US D482,820 S**

(45) **Date of Patent:** **** Nov. 25, 2003**

(54) **AUTOMATIC HAIR WASHER**

(75) Inventor: **Nobuyuki Minami**, Osaka (JP)

(73) Assignee: **Oohiro Works, Ltd.** (JP)

(**) Term: **14 Years**

(21) Appl. No.: **29/150,754**

(22) Filed: **Nov. 28, 2001**

(30) **Foreign Application Priority Data**

Jun. 11, 2001 (JP) 2001-017011

(51) **LOC (7) Cl.** **28-03**

(52) **U.S. Cl.** **D28/20**

(58) **Field of Search** D28/20; 4/515-523

(56) **References Cited**

U.S. PATENT DOCUMENTS

5,906,012 A * 5/1999 Sakane et al. 4/519
6,243,888 B1 * 6/2001 Shimizu 4/515

FOREIGN PATENT DOCUMENTS

JP 1117268 8/2001

OTHER PUBLICATIONS

U.S. patent application Ser. No. 29/124,731, filed Jun. 2000, Minami.

* cited by examiner

Primary Examiner—Jennifer Rivard

(74) *Attorney, Agent, or Firm*—Wall Marjama & Bilinski LLP

(57) **CLAIM**

The ornamental design for an automatic hair washer, as shown and described.

DESCRIPTION

FIG. 1 is a front elevation of an automatic hair washer in accordance with my new design; FIG. 2 is a rear elevation thereof; FIG. 3 is a right side view thereof; FIG. 4 is a left side view thereof; FIG. 5 is a top view thereof; FIG. 6 is a bottom view thereof; and, FIG. 7 is a front perspective view thereof.

1 Claim, 4 Drawing Sheets

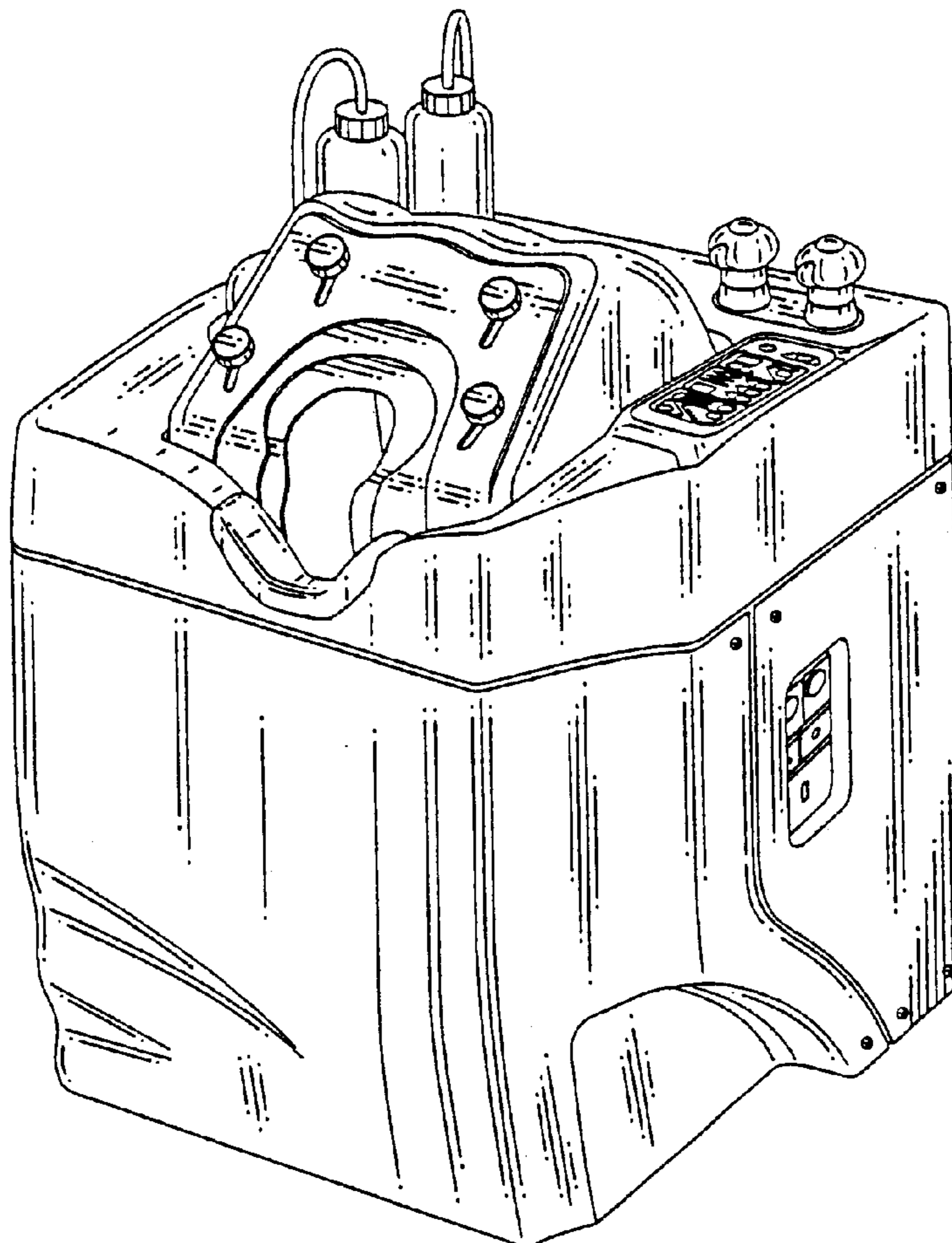

Fig.1

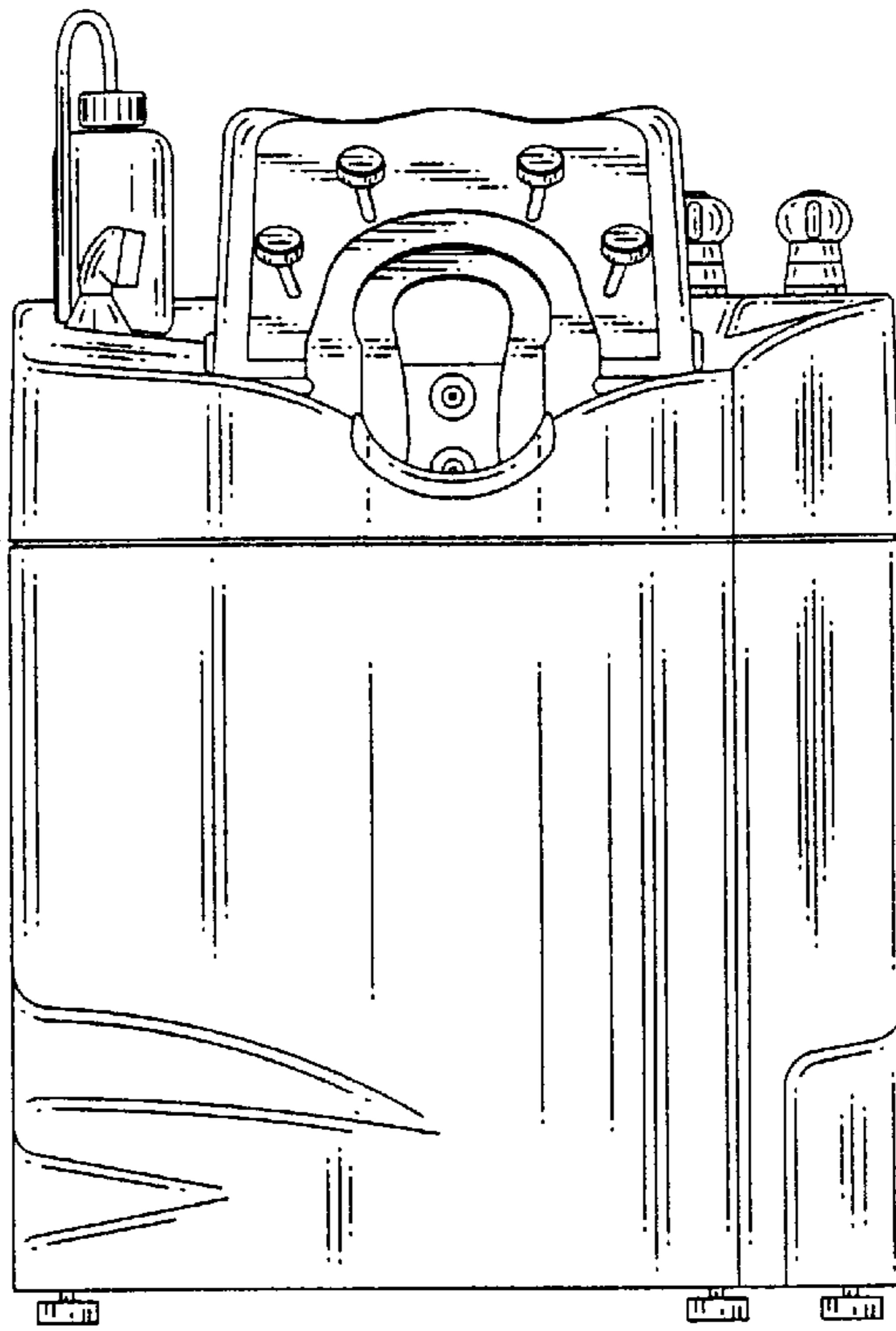

Fig.2

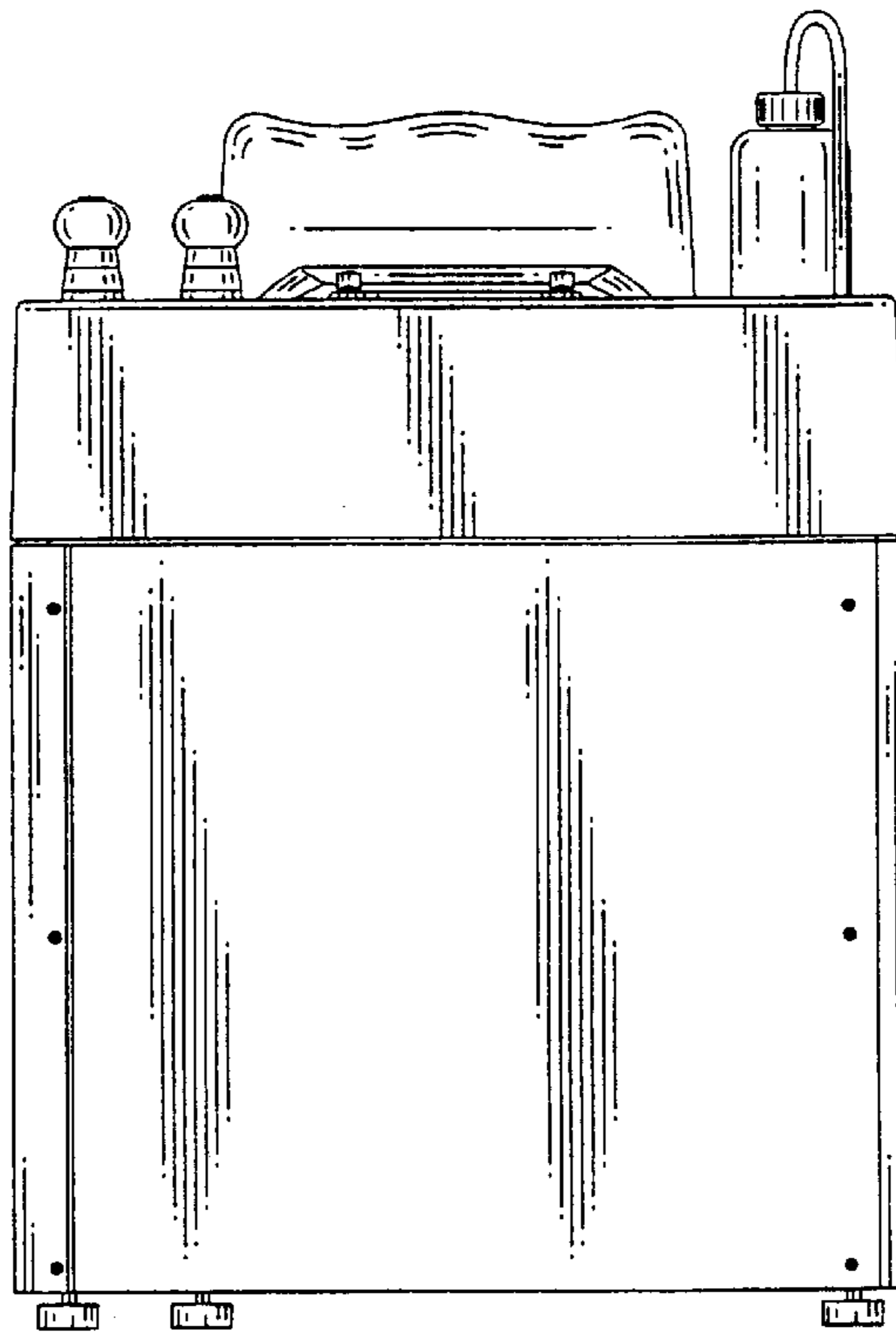

Fig.3

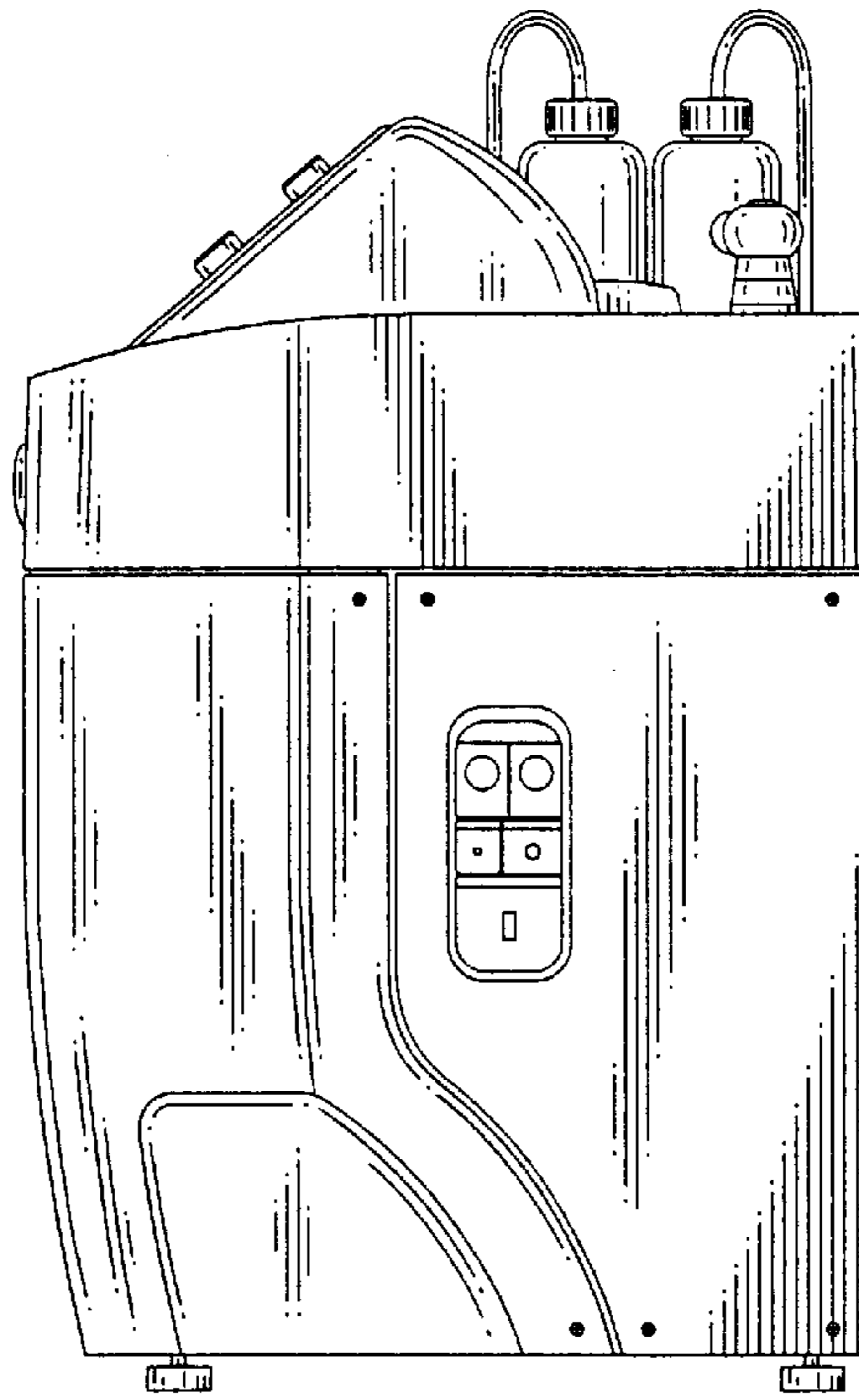

Fig.4

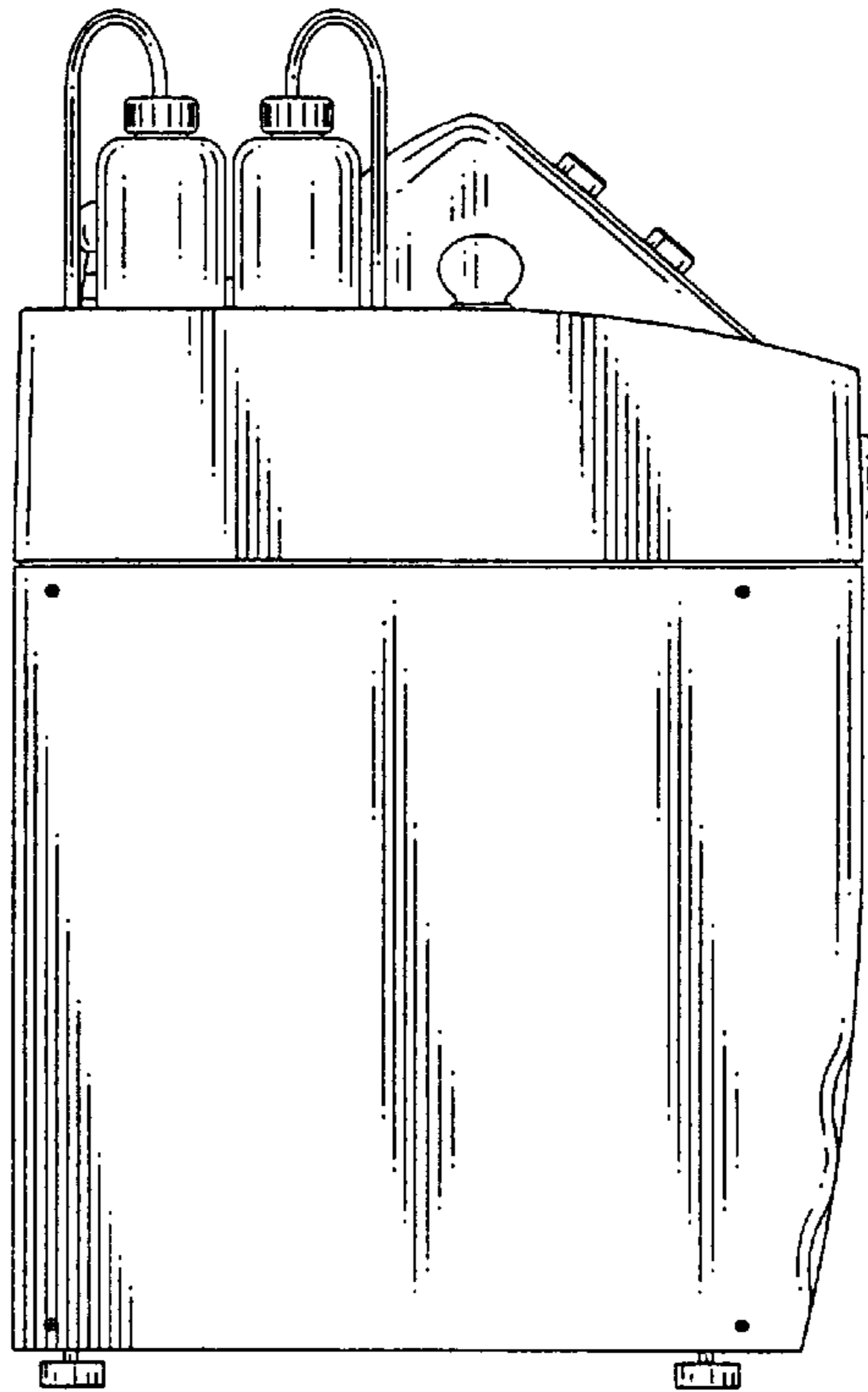

Fig.5

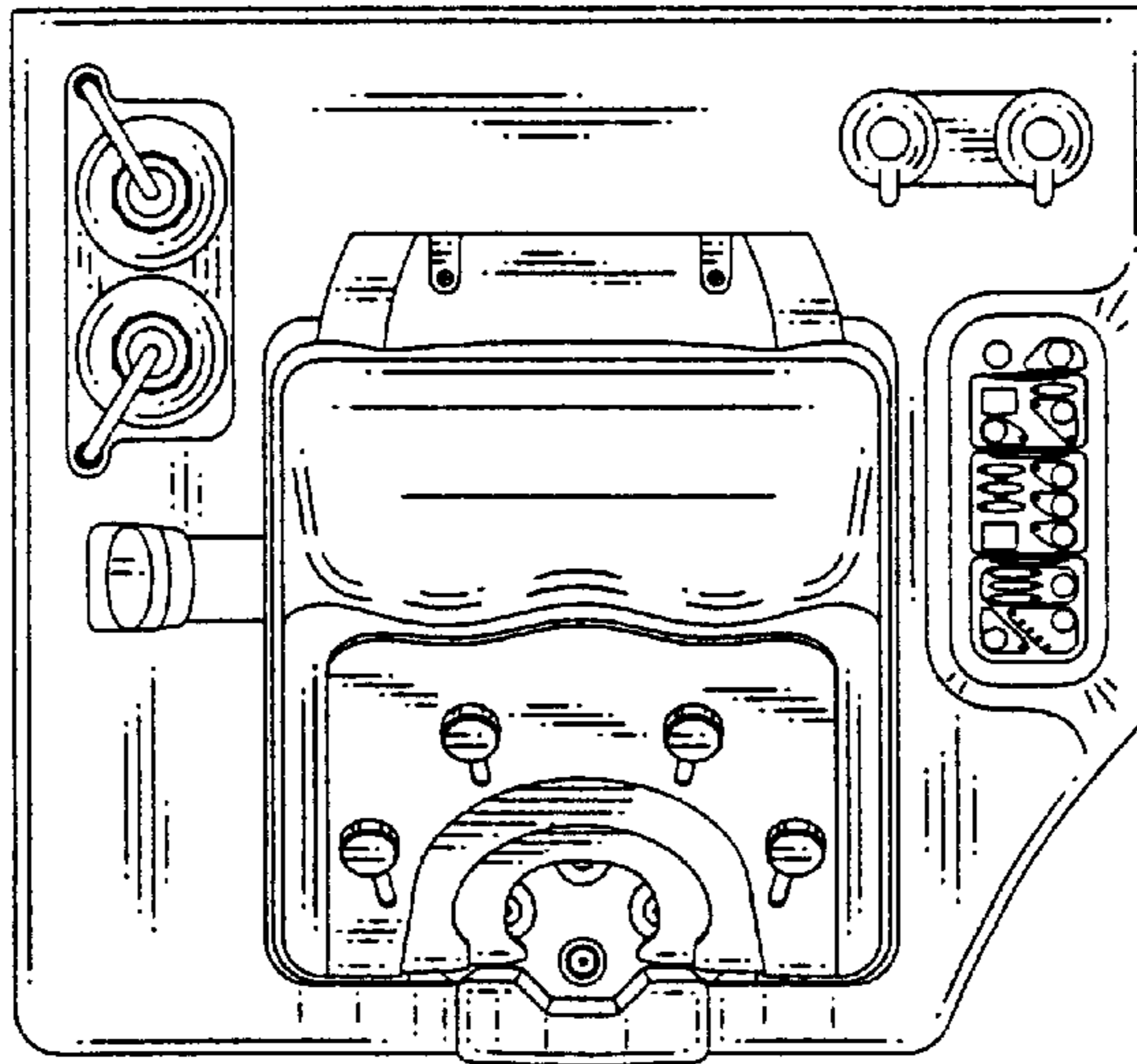

Fig.6

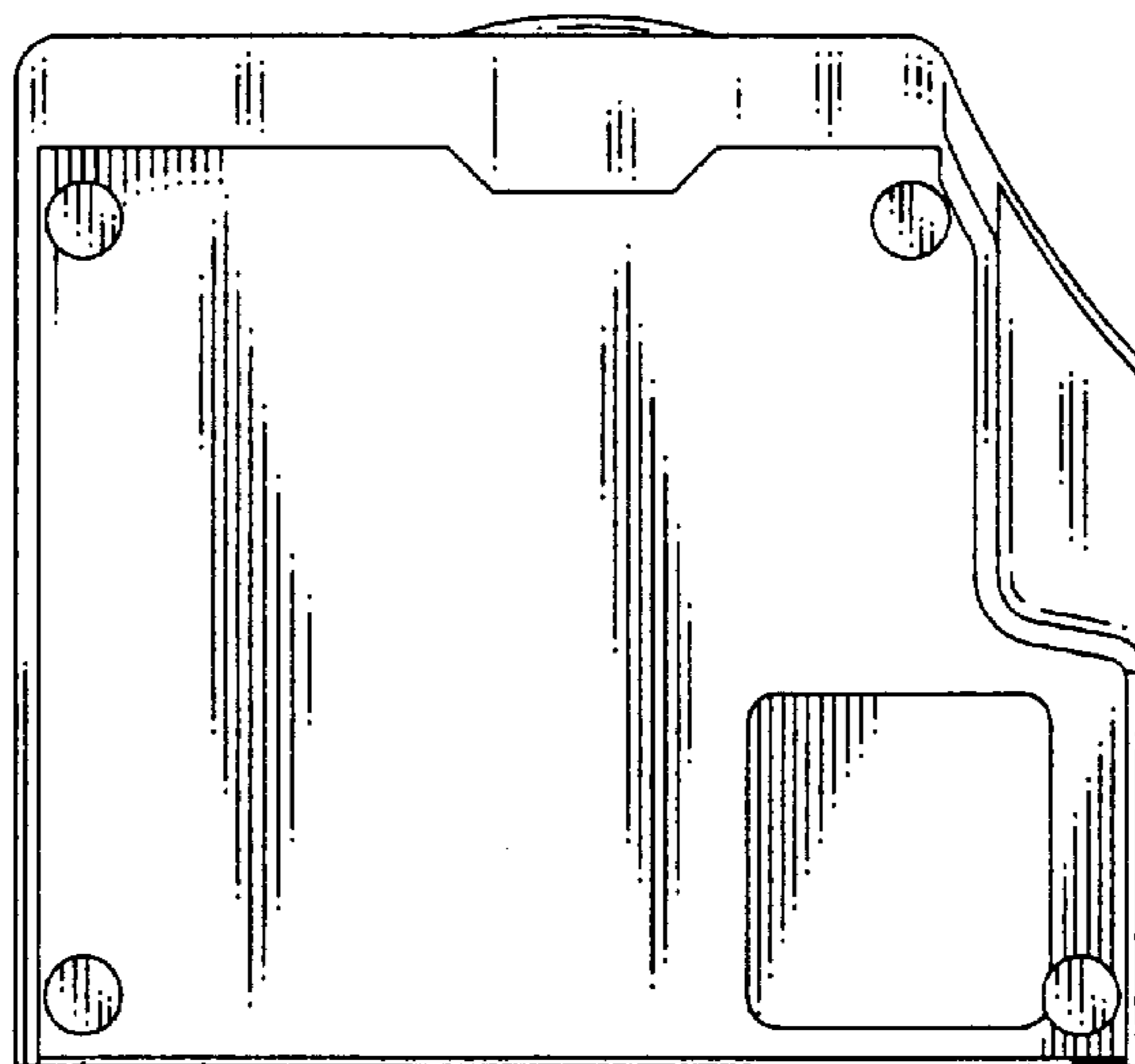

Fig.7

