



US00D482811S

(12) **United States Design Patent**
Petzl

(10) **Patent No.:** **US D482,811 S**

(45) **Date of Patent:** **** Nov. 25, 2003**

(54) **FRONTAL LAMP**

(75) Inventor: **Paul Petzl**, Barraux (FR)

(73) Assignee: **Zedel**, Crolles (FR)

(**) Term: **14 Years**

(21) Appl. No.: **29/174,327**

(22) Filed: **Jan. 16, 2003**

(30) **Foreign Application Priority Data**

Jul. 22, 2002 (WO) DM/060 797

(51) **LOC (7) Cl.** **26-02**

(52) **U.S. Cl.** **D26/39**

(58) **Field of Search** D26/37-50; 362/103,
362/105, 157, 158, 171, 172, 173, 183-208

(56) **References Cited**

U.S. PATENT DOCUMENTS

D445,931 S * 7/2001 Shiu D26/39

D447,587 S * 9/2001 Poon D26/39

D465,043 S * 10/2002 Halasz D26/39

D472,998 S * 4/2003 Paris et al. D26/39

* cited by examiner

Primary Examiner—Marcus A. Jackson

(74) *Attorney, Agent, or Firm*—Oliff & Berridge, PLC

(57) **CLAIM**

The ornamental design for a frontal lamp, as shown and described.

DESCRIPTION

FIG. 1 is a front view of a first embodiment of a frontal lamp;

FIG. 2 is a front perspective view thereof;

FIG. 3 is a rear view thereof;

FIG. 4 is a rear perspective view thereof;

FIG. 5 is a left side view thereof;

FIG. 6 is a right side view thereof;

FIG. 7 is a top view thereof;

FIG. 8 is a bottom view thereof;

FIG. 9 is a front view of a second embodiment of a frontal lamp;

FIG. 10 is a front perspective view thereof;

FIG. 11 is a rear view thereof;

FIG. 12 is a rear perspective view thereof;

FIG. 13 is a left side view thereof;

FIG. 14 is a right side view thereof;

FIG. 15 is a top view thereof; and,

FIG. 16 is a bottom view thereof.

The frontal lamp can be attached to a forehead of a user by head straps threaded through strapholders on the rear of the frontal lamp.

1 Claim, 8 Drawing Sheets

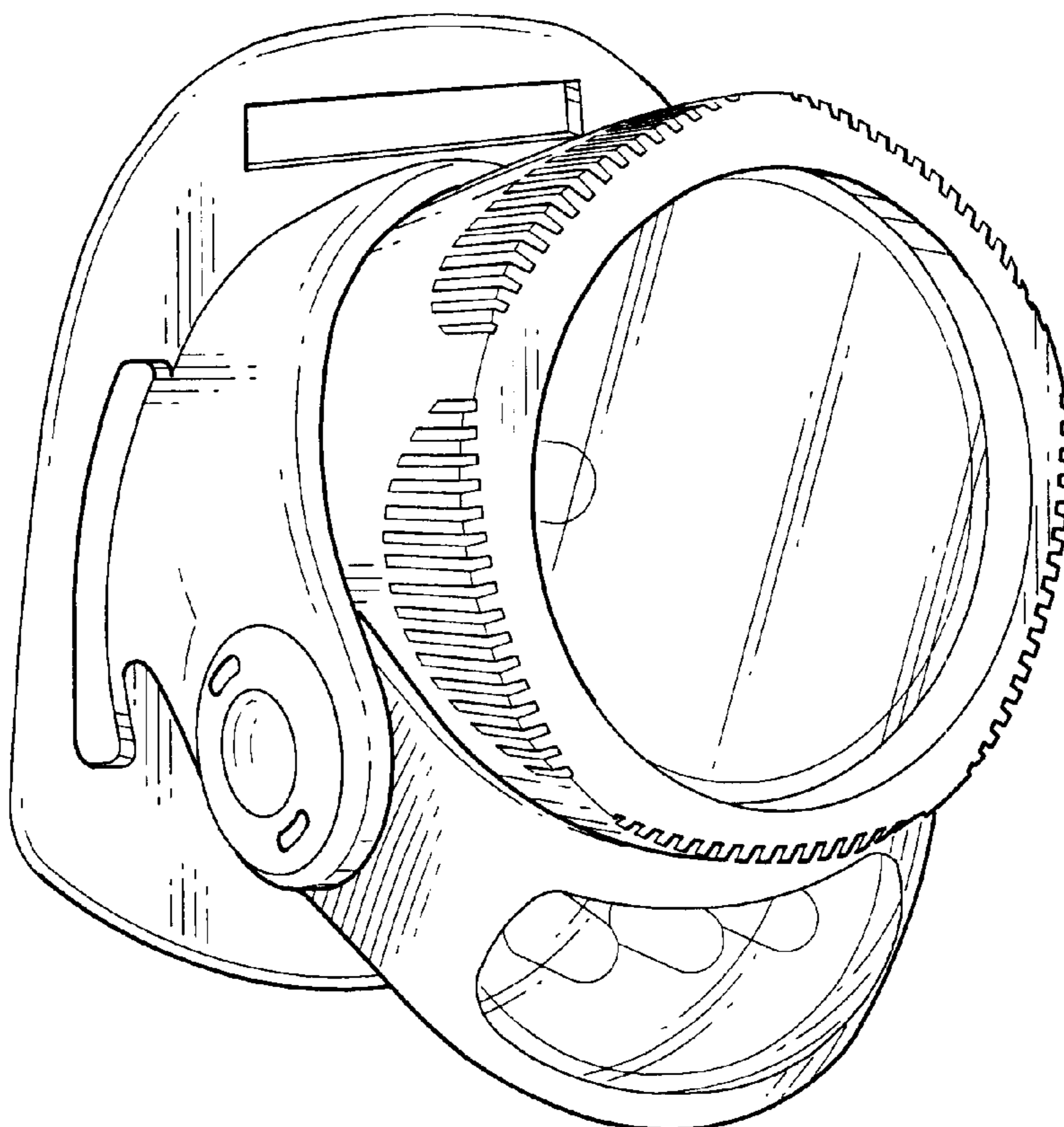

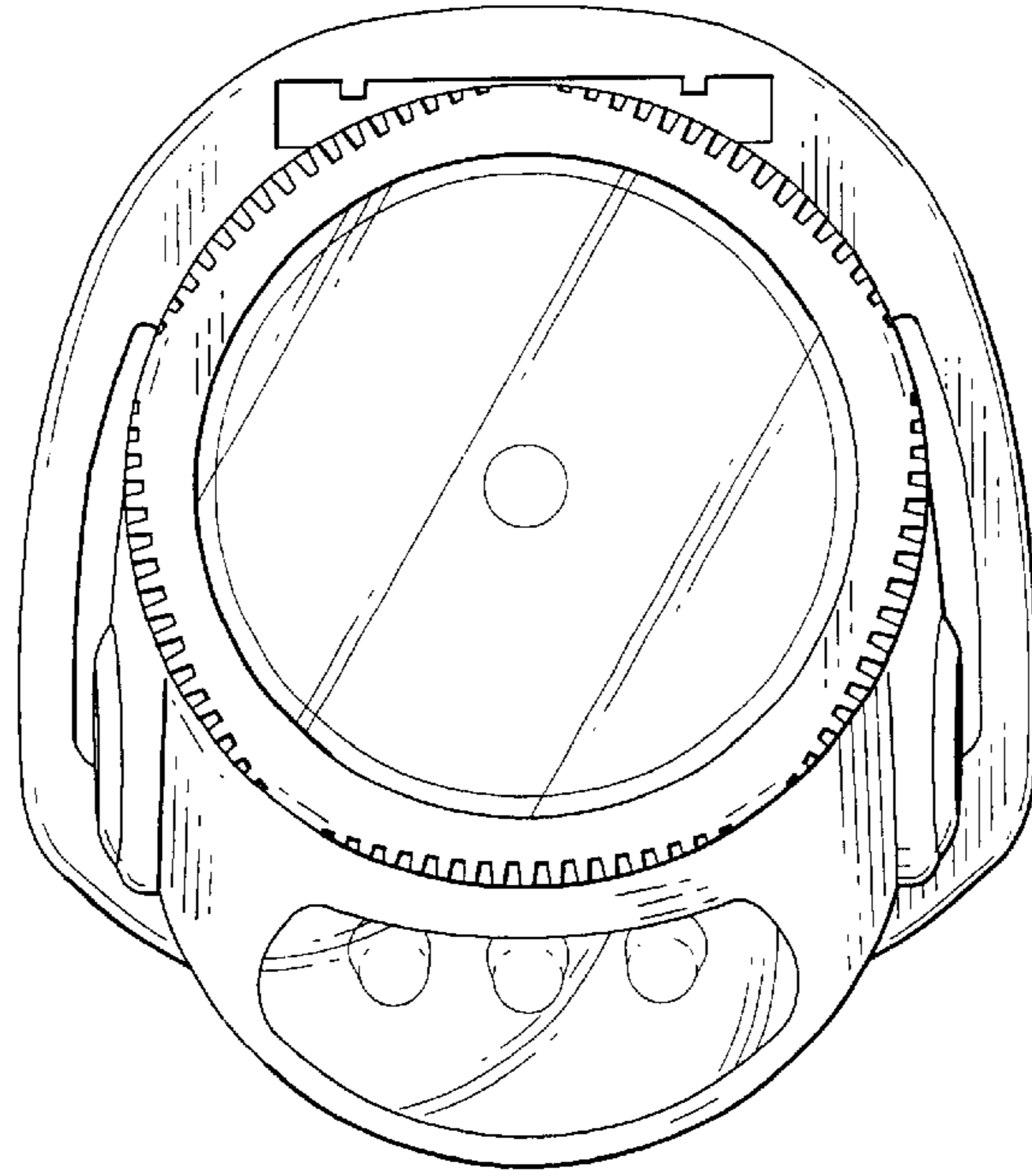

Fig. 1

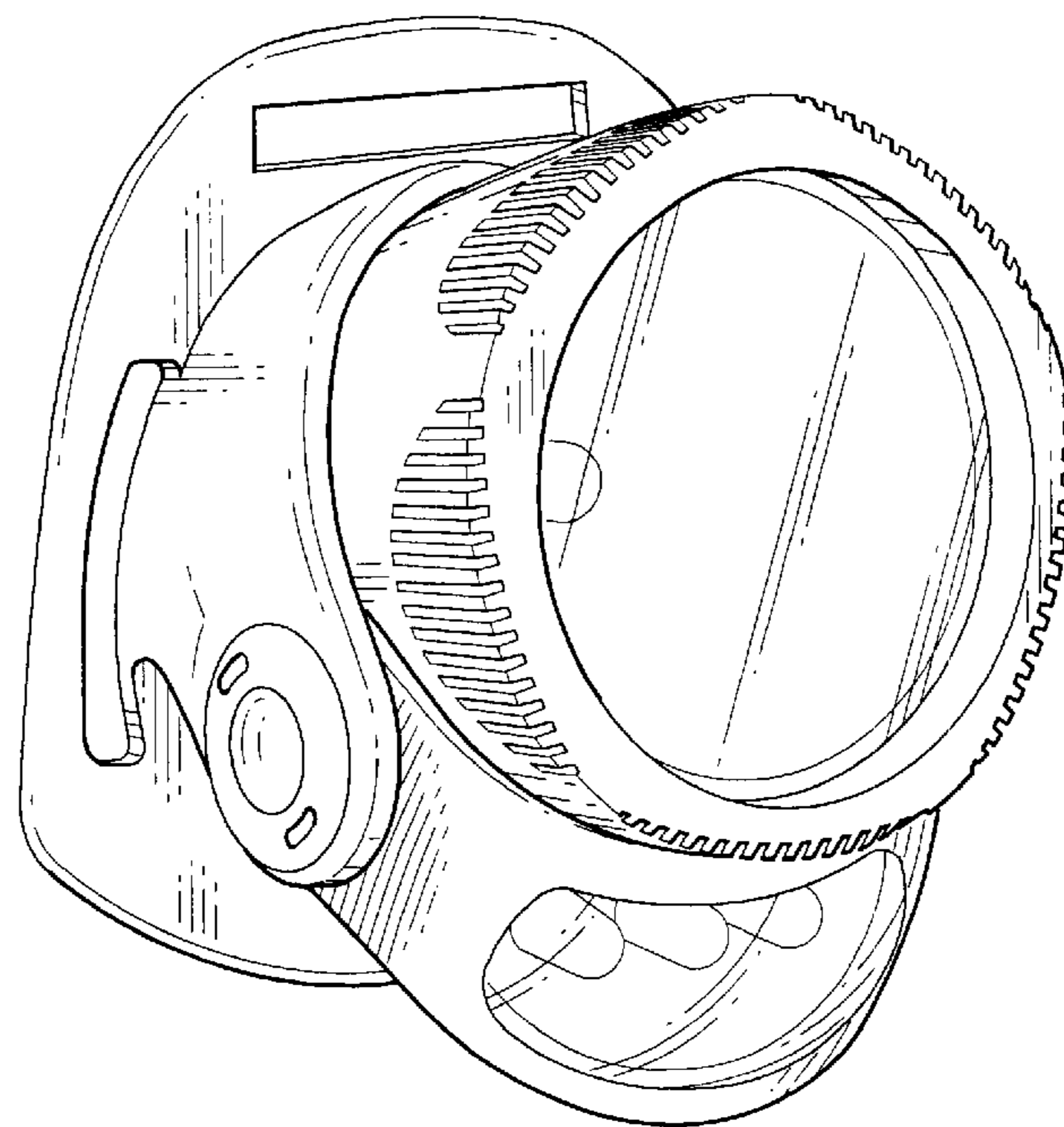

Fig. 2

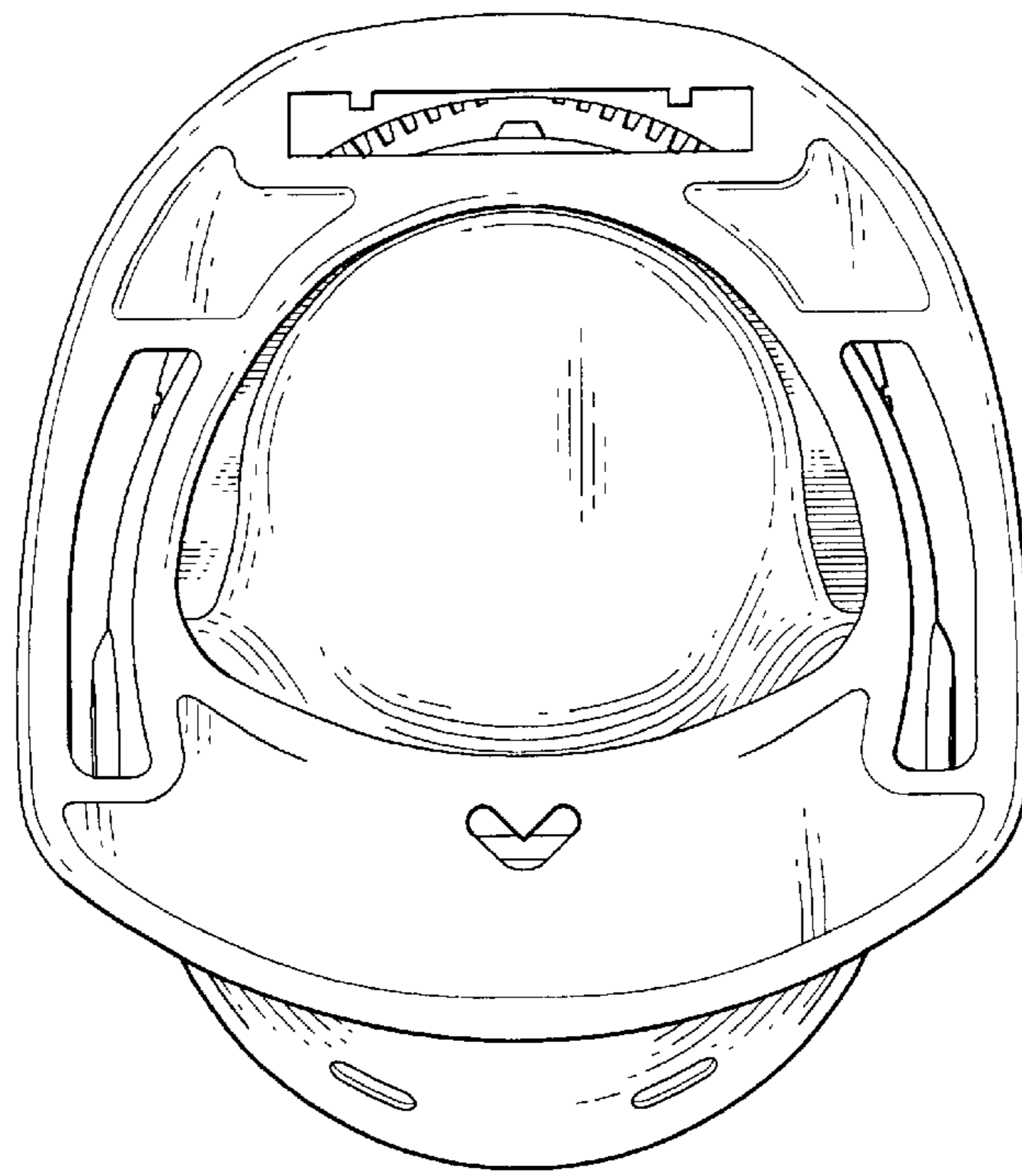

Fig. 3

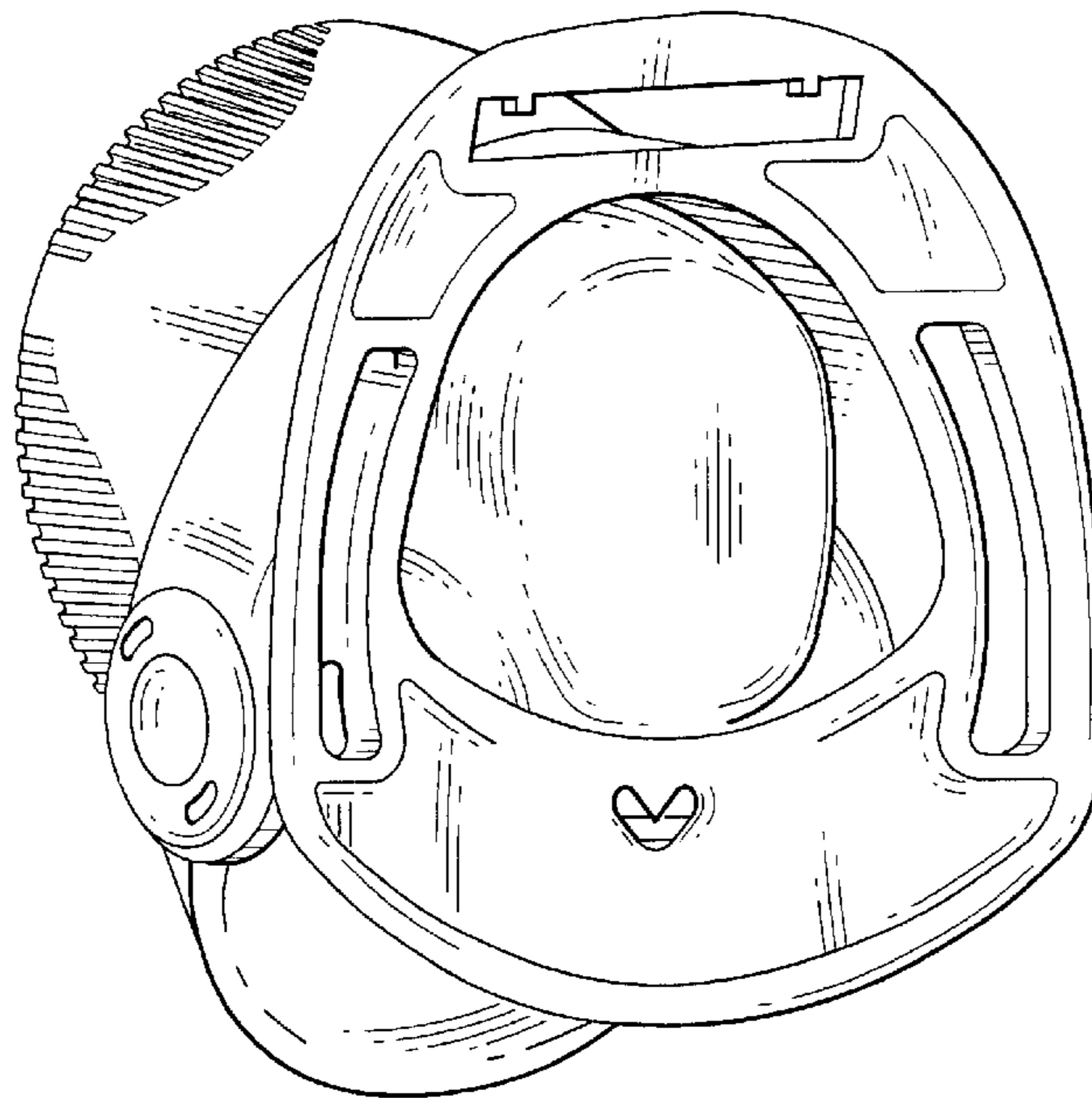

Fig. 4

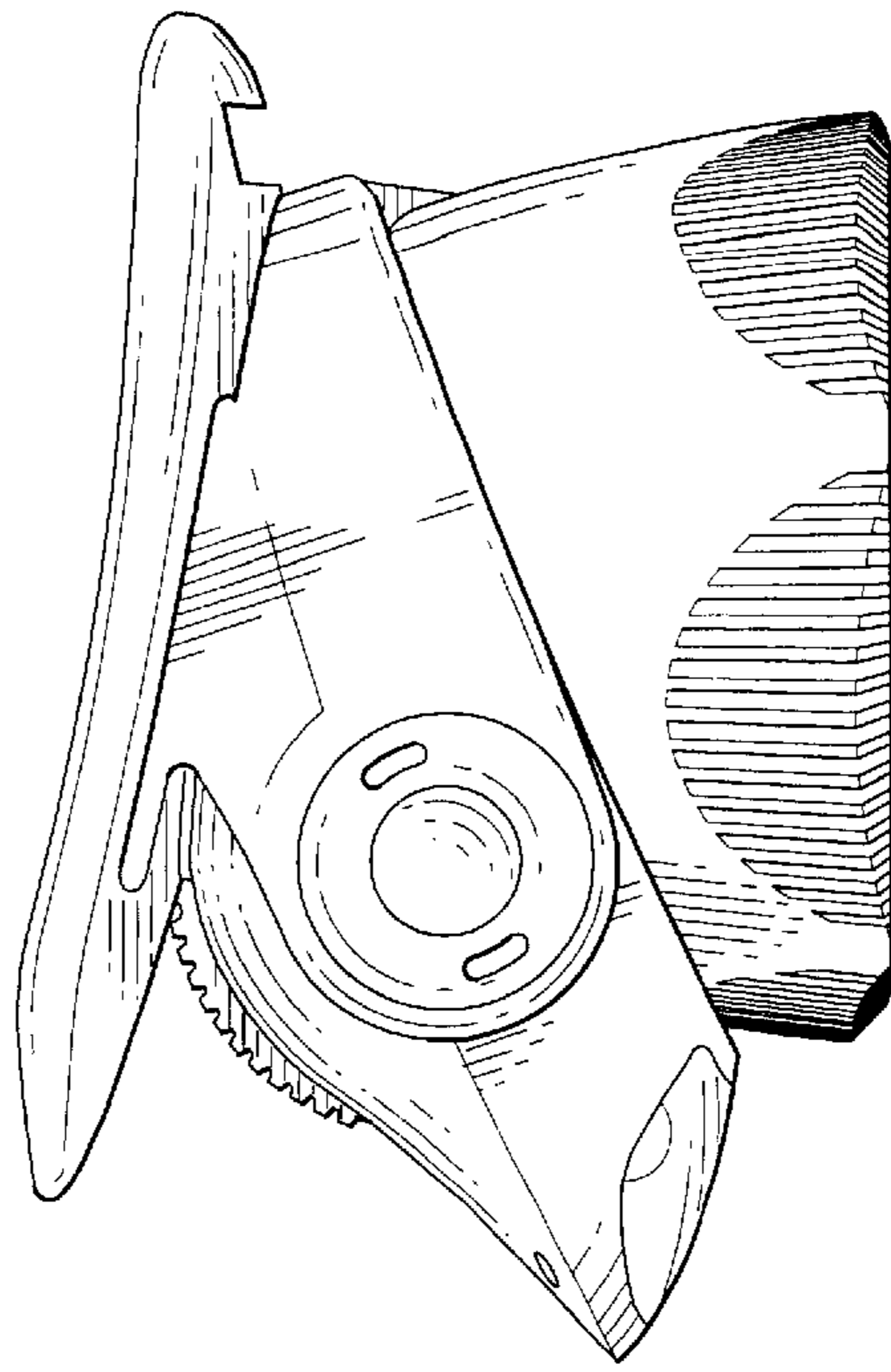

Fig. 5

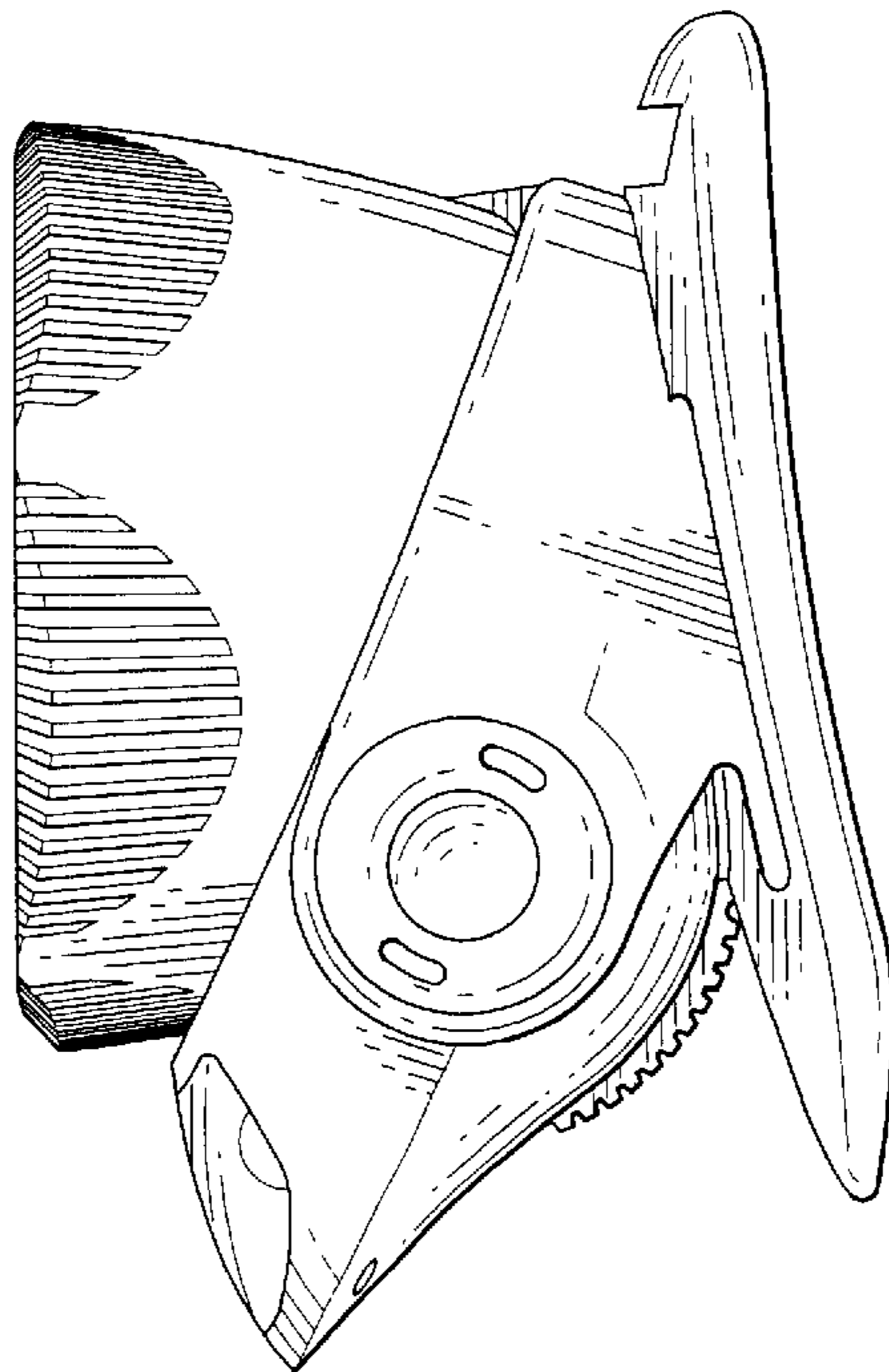

Fig. 6

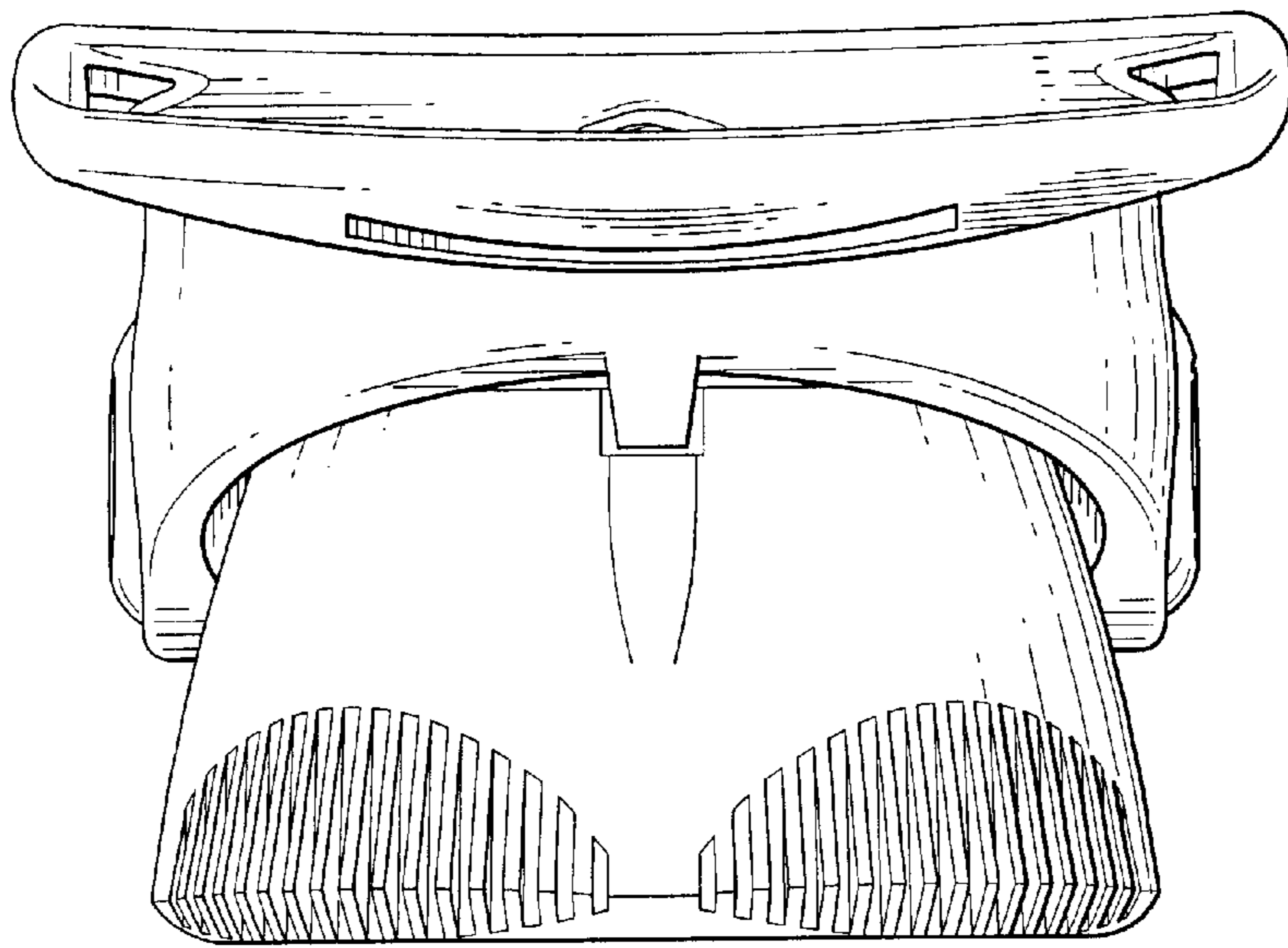

Fig. 7

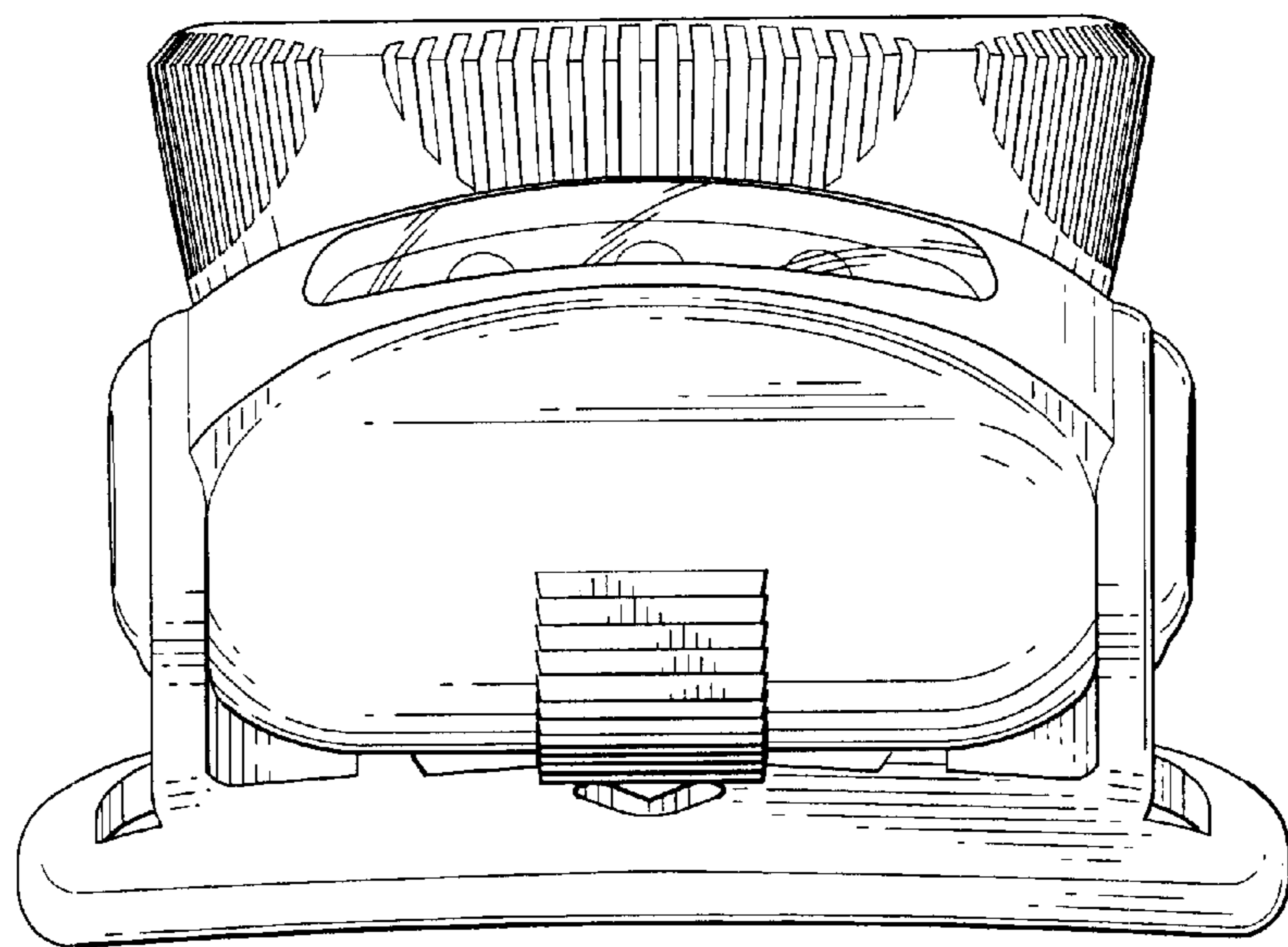

Fig. 8

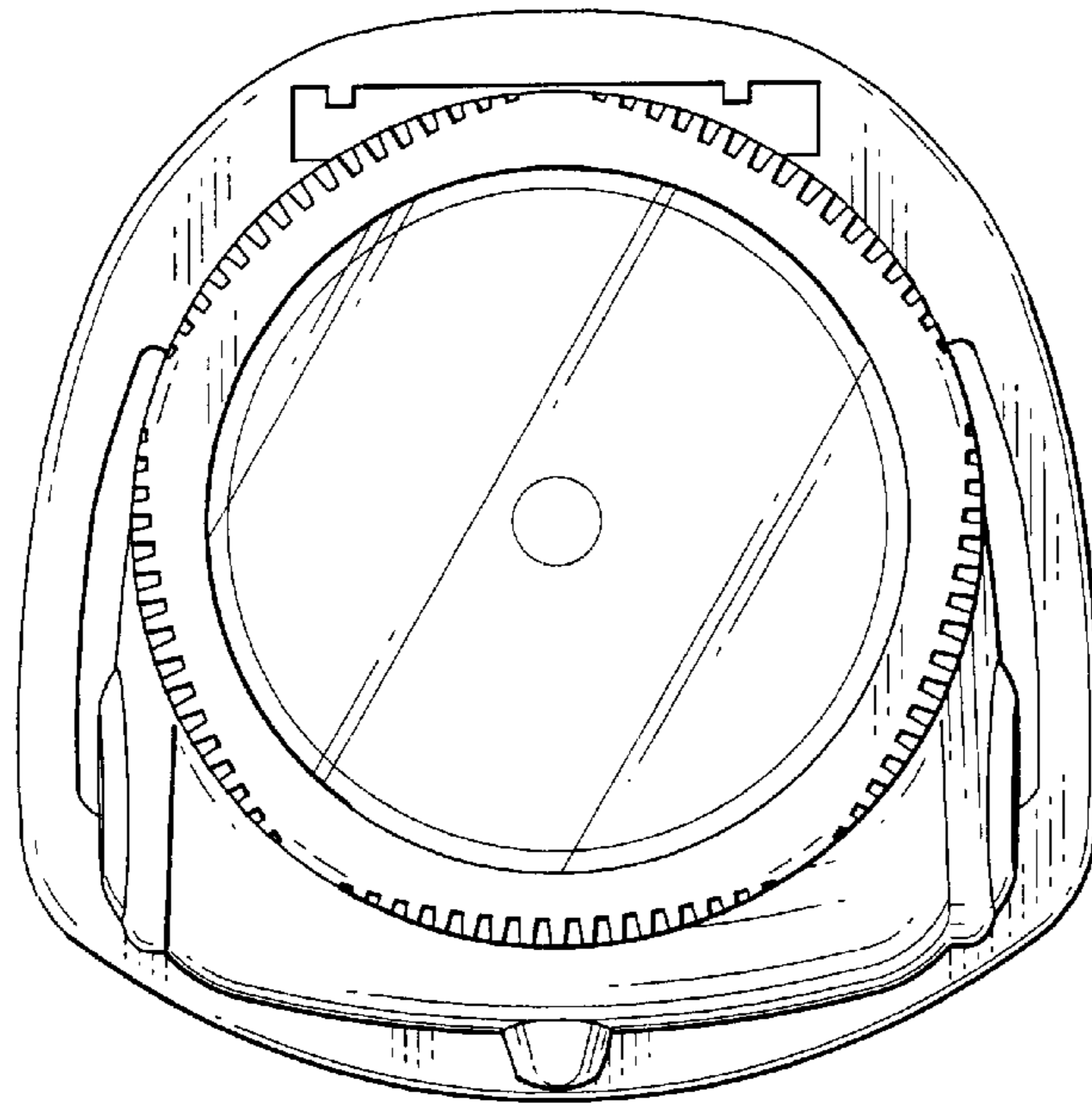

Fig. 9

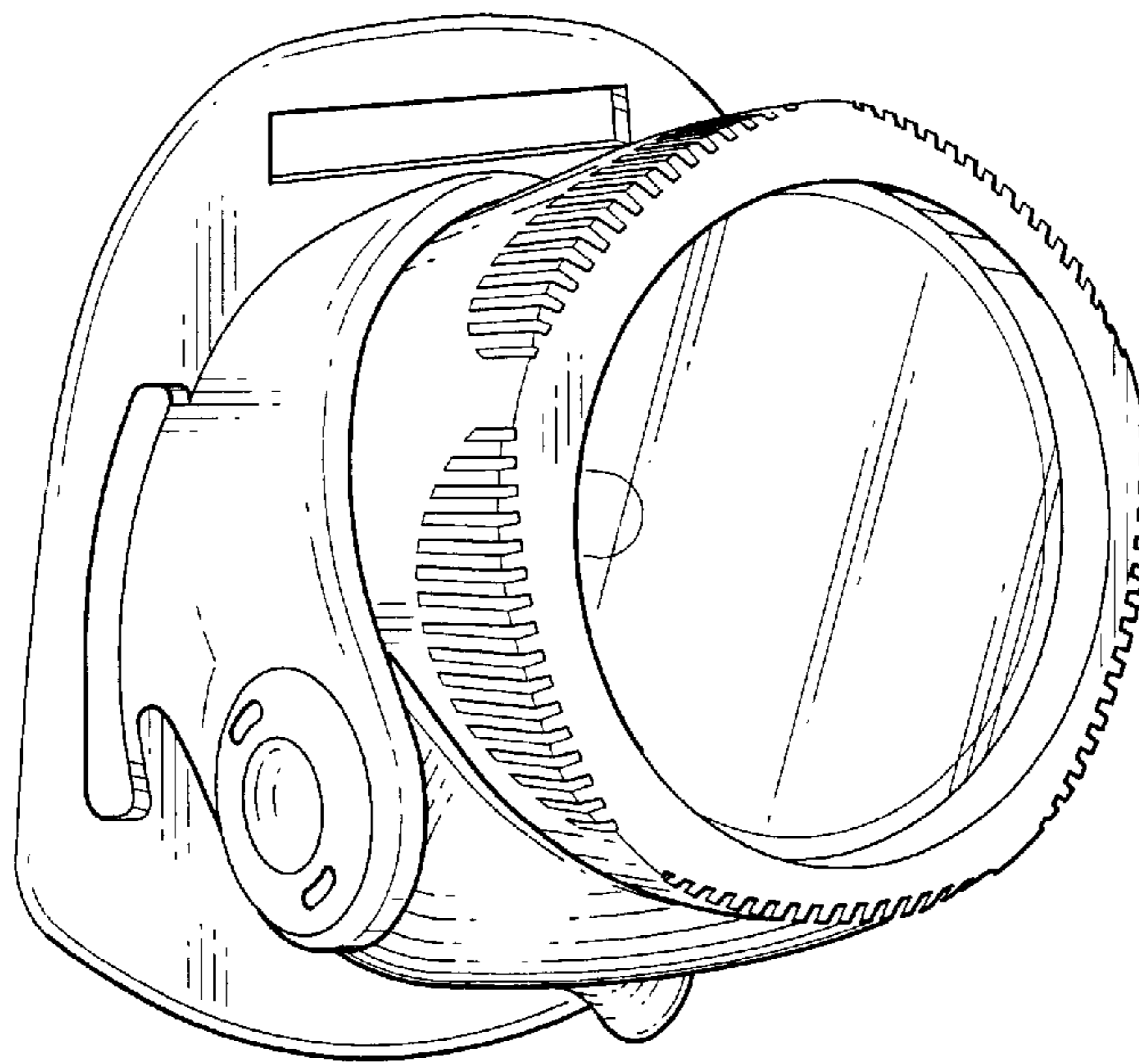

Fig. 10

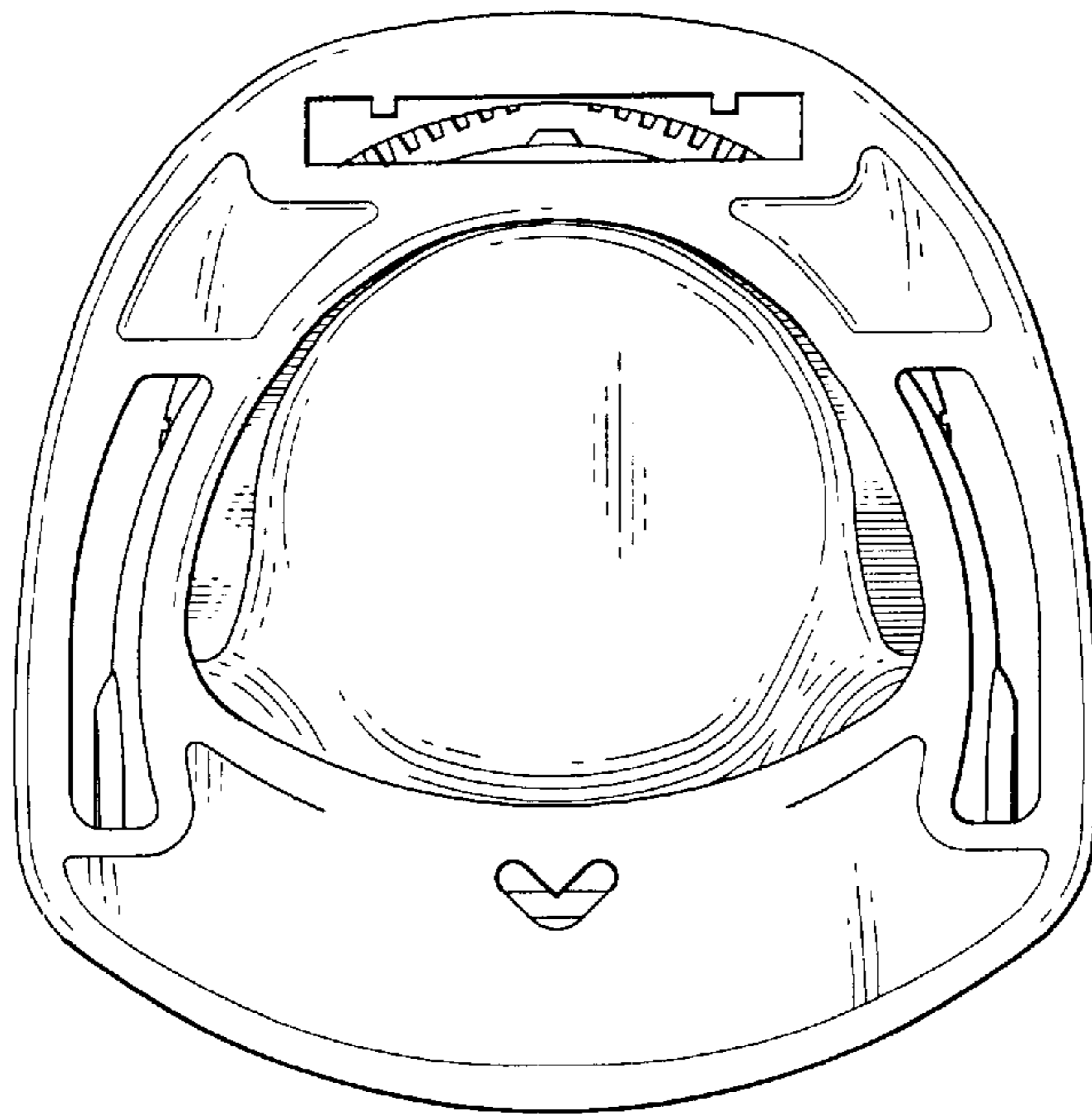

Fig. 11

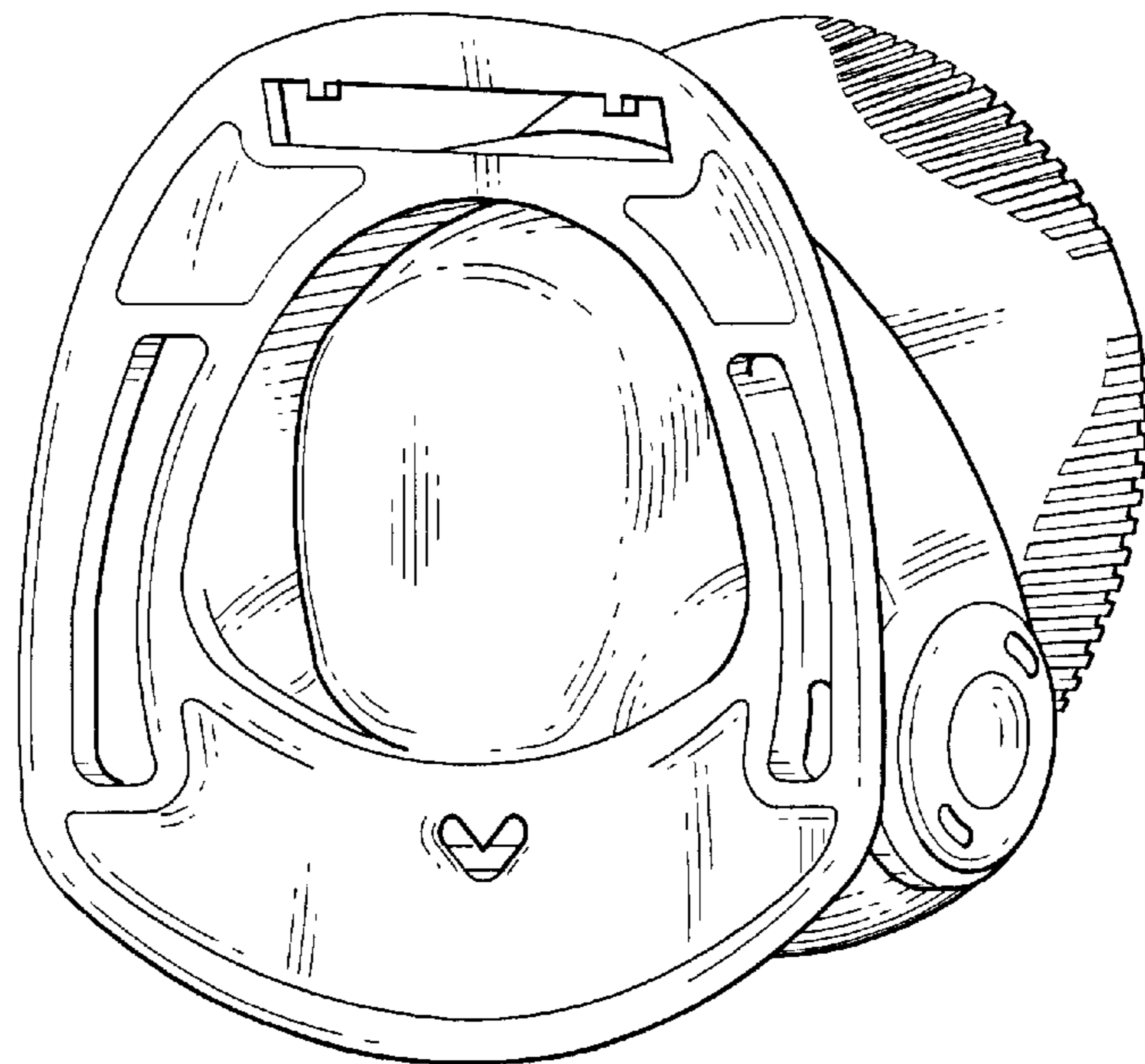

Fig. 12

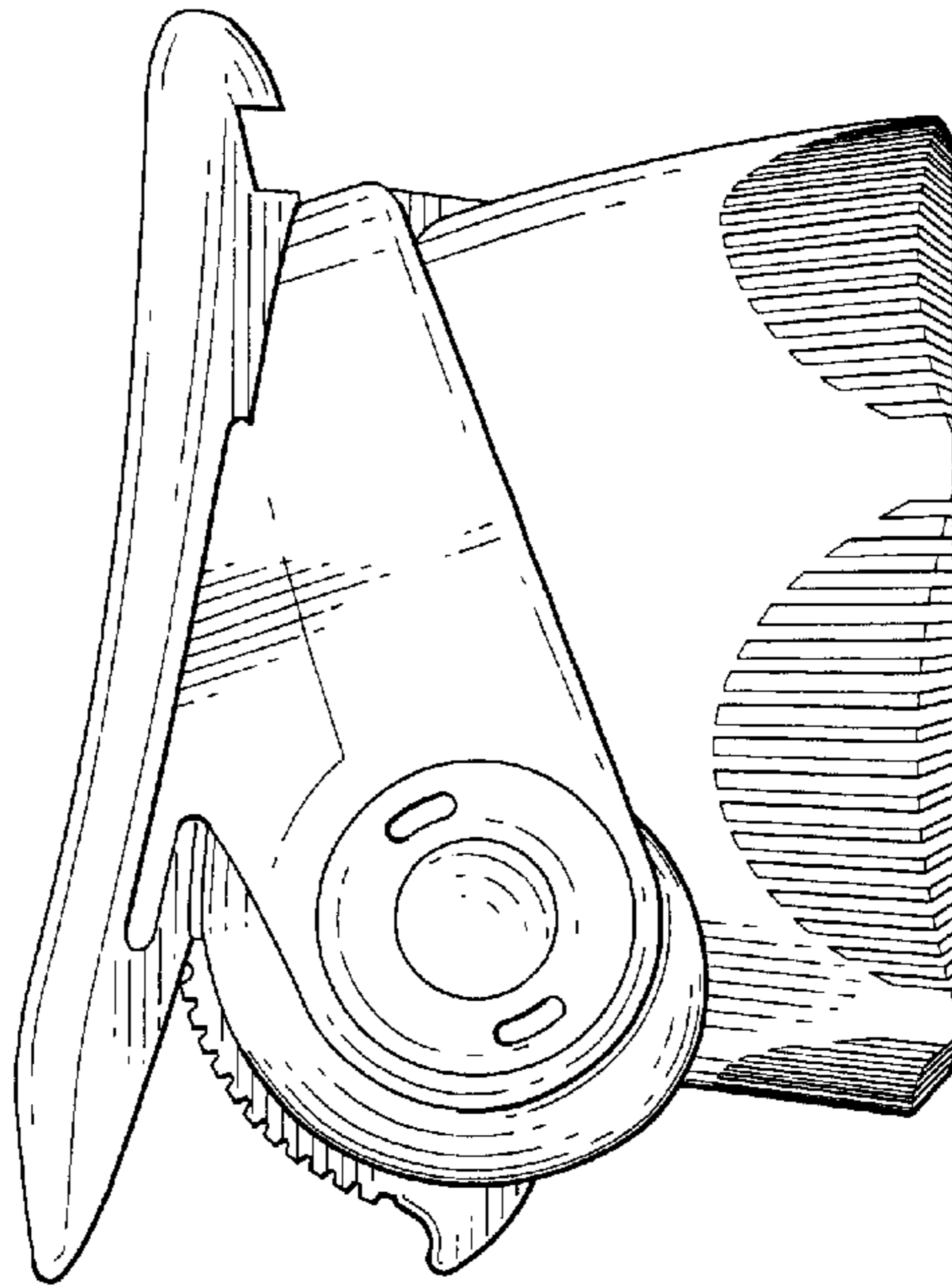

Fig. 13

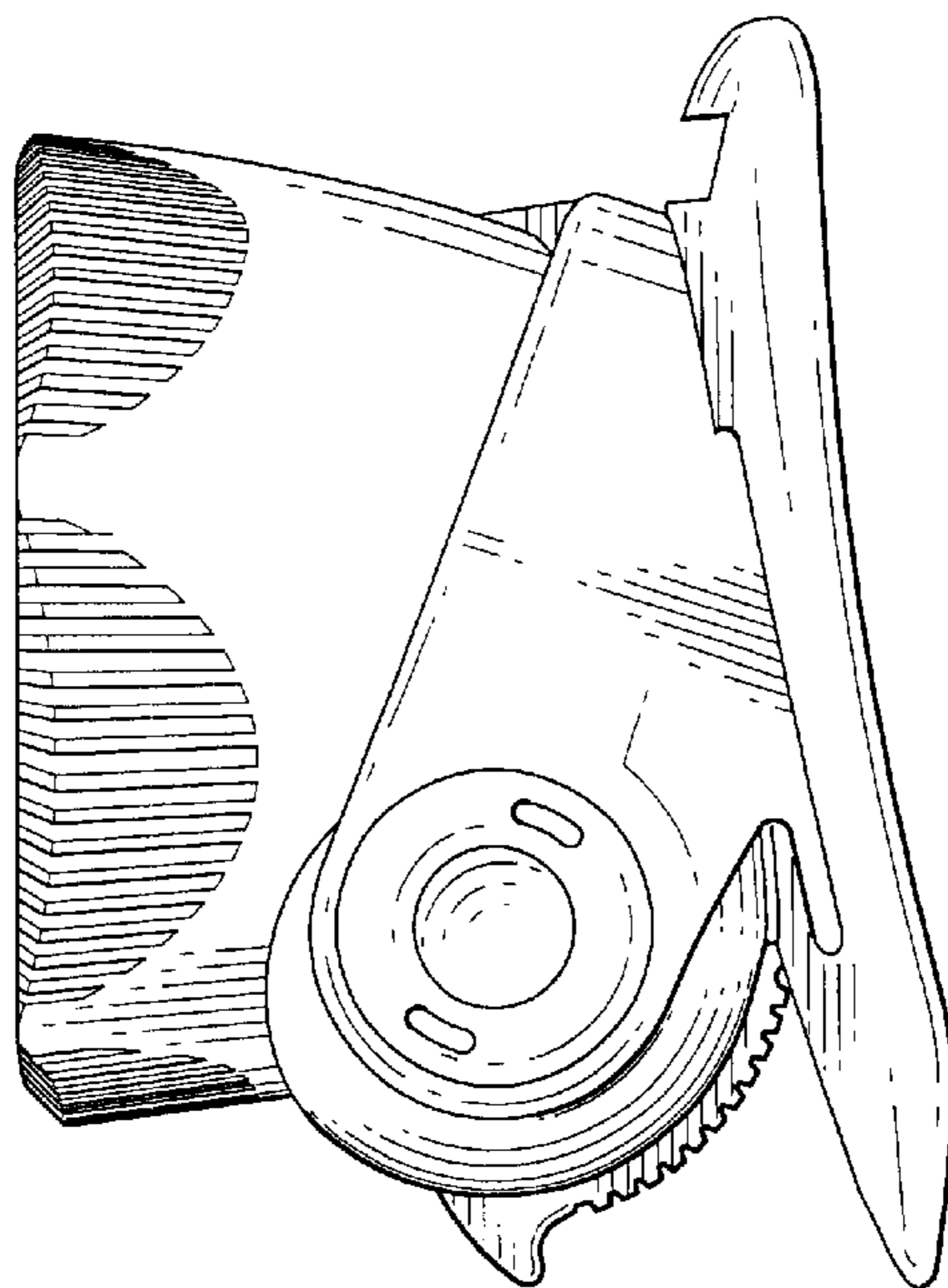

Fig. 14

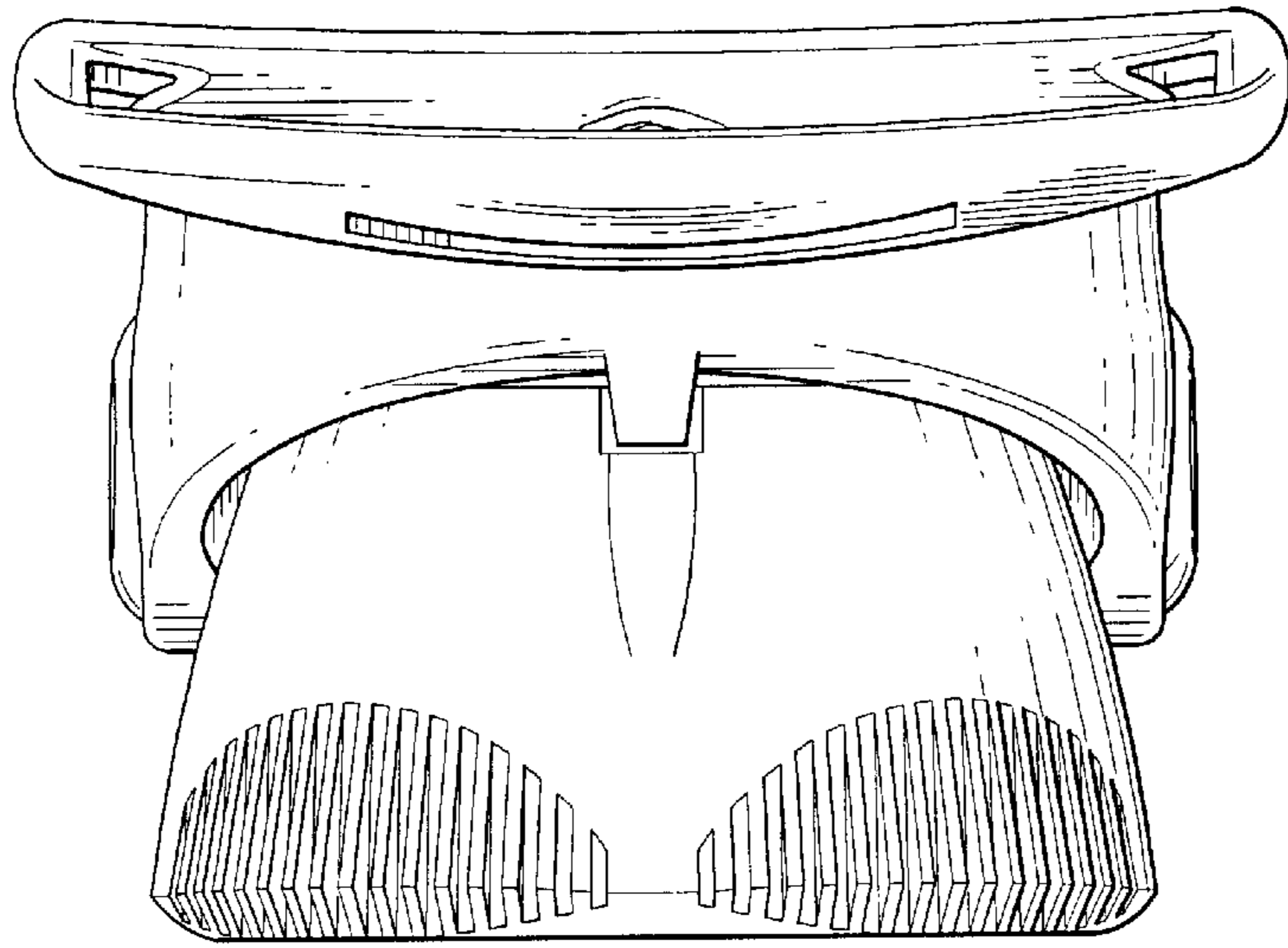

Fig. 15

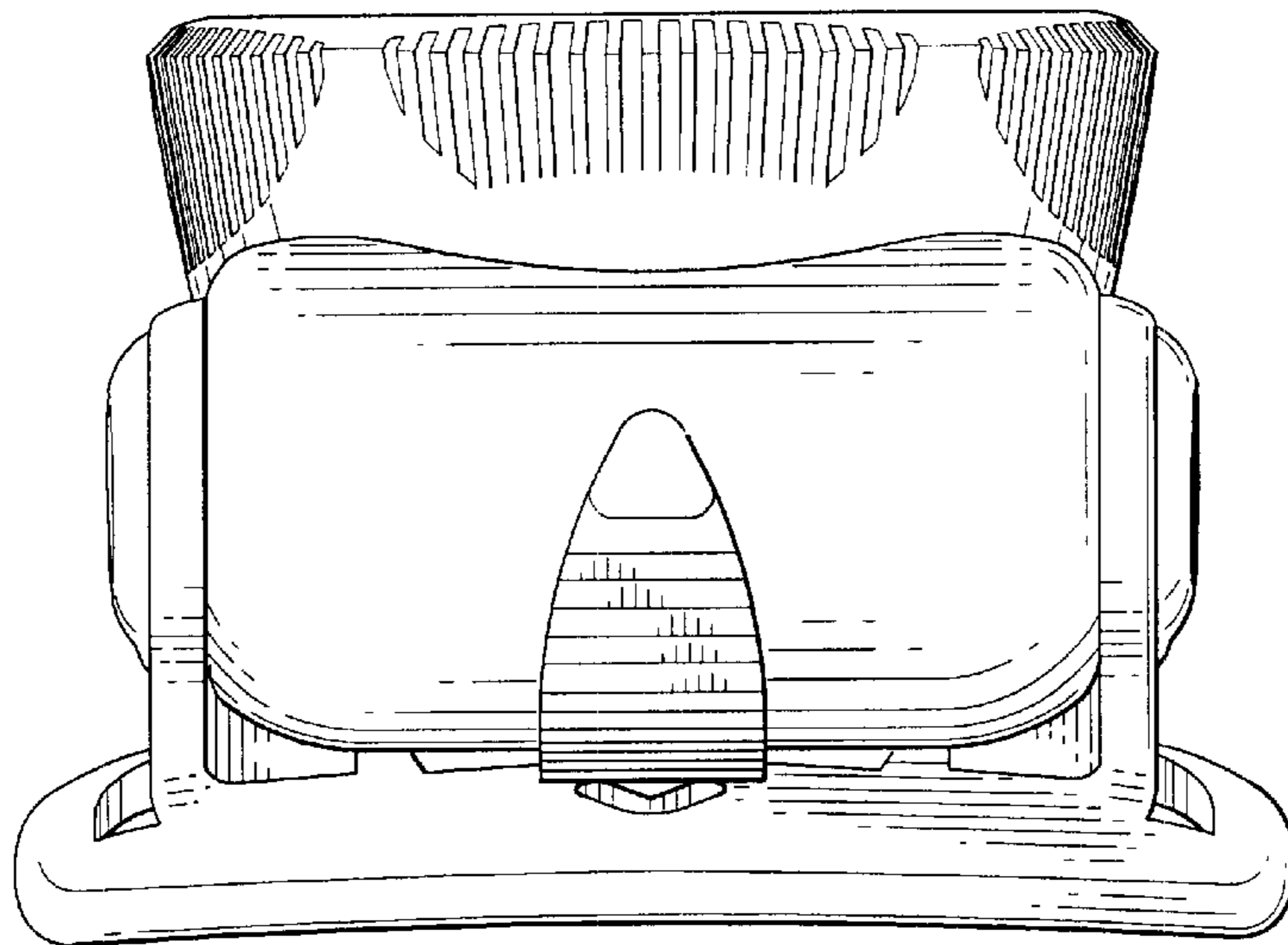

Fig. 16