



US00D482774S

(12) **United States Design Patent**
Stauffer

(10) **Patent No.:** **US D482,774 S**

(45) **Date of Patent:** **** Nov. 25, 2003**

(54) **CEILING FAN BLADE IRON**

(75) Inventor: **Michael J. Stauffer**, Memphis, TN
(US)

(73) Assignee: **Hunter Fan Company**, Memphis, TN
(US)

(**) Term: **14 Years**

(21) Appl. No.: **29/168,694**

(22) Filed: **Oct. 3, 2002**

(51) **LOC (7) Cl.** **23-04**

(52) **U.S. Cl.** **D23/411**

(58) **Field of Search** D23/411, 377,
D23/379, 385; 416/5, 210 R; 392/364

(56) **References Cited**

U.S. PATENT DOCUMENTS

D382,955 S * 8/1997 Liu D23/411
D409,302 S * 5/1999 Zuege D23/411

OTHER PUBLICATIONS

Casablanca Fan Company 2002 Product Catalog: Cathay p. 20, Nouvelle p. 25, Aegena p. 27, Bella p. 31, le Grande p. 47, Utopian p. 50 Bel Air p. 38, Estrada p. 49.

Hunter Prestige 2002; Hunter Fan Company, 2500 Frisco Avenue, Memphis TN 38114 Hampshire, Millennium, Salinas, 52' Dominion.

* cited by examiner

Primary Examiner—Lisa Lichtenstein
(74) *Attorney, Agent, or Firm*—Baker Donelson

(57) **CLAIM**

The ornamental design for a ceiling fan blade iron, as shown and described.

DESCRIPTION

FIG. 1 is a perspective view of a ceiling fan blade iron showing my new design, shown in an inverted position for clarity.

FIG. 2 is a top view thereof.

FIG. 3 is a bottom view thereof.

FIG. 4 is a right side view thereof.

FIG. 5 is a left side view thereof.

FIG. 6 is a front view thereof; and,

FIG. 7 is a rear view thereof.

1 Claim, 4 Drawing Sheets

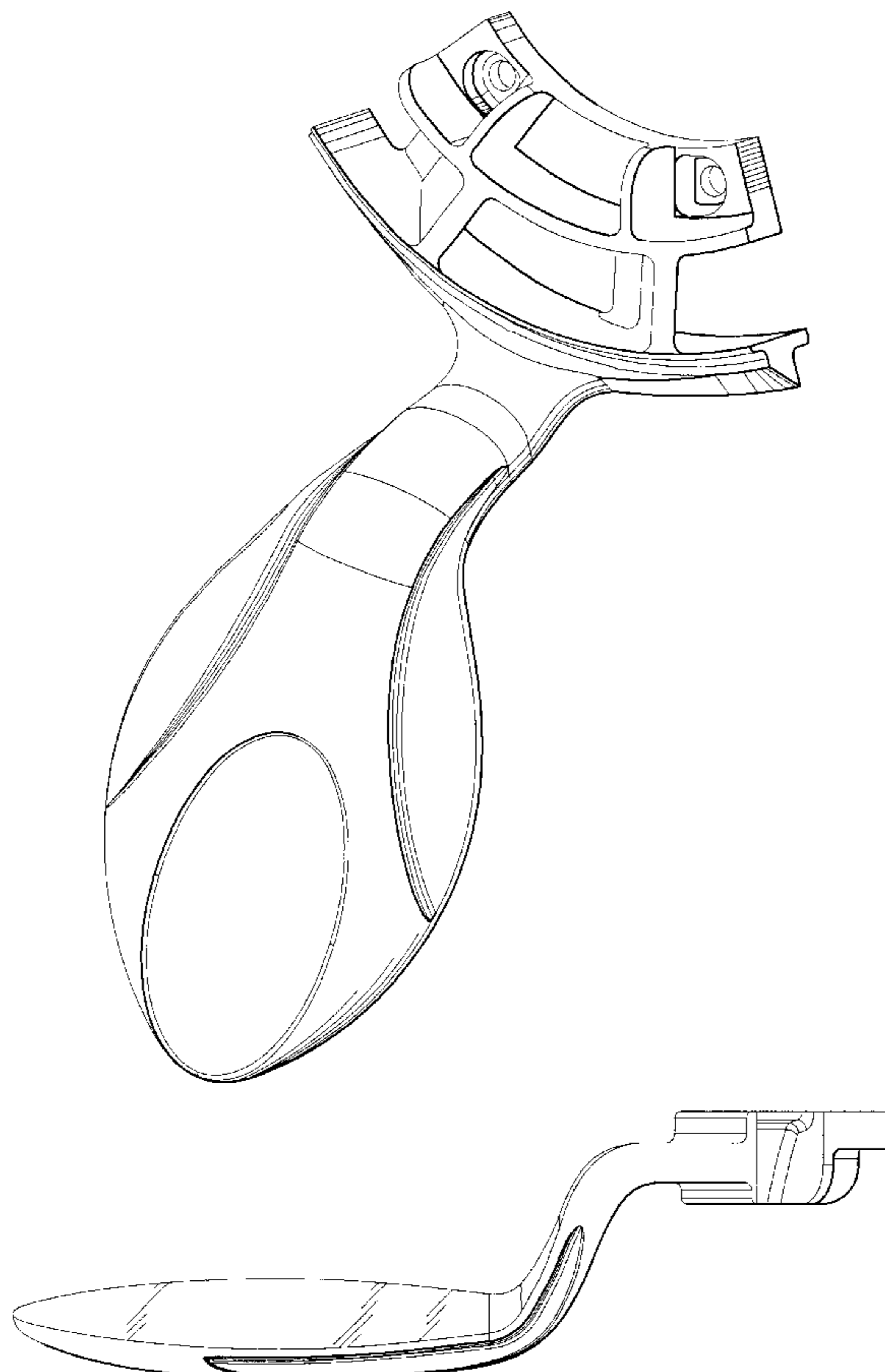

Fig. 1

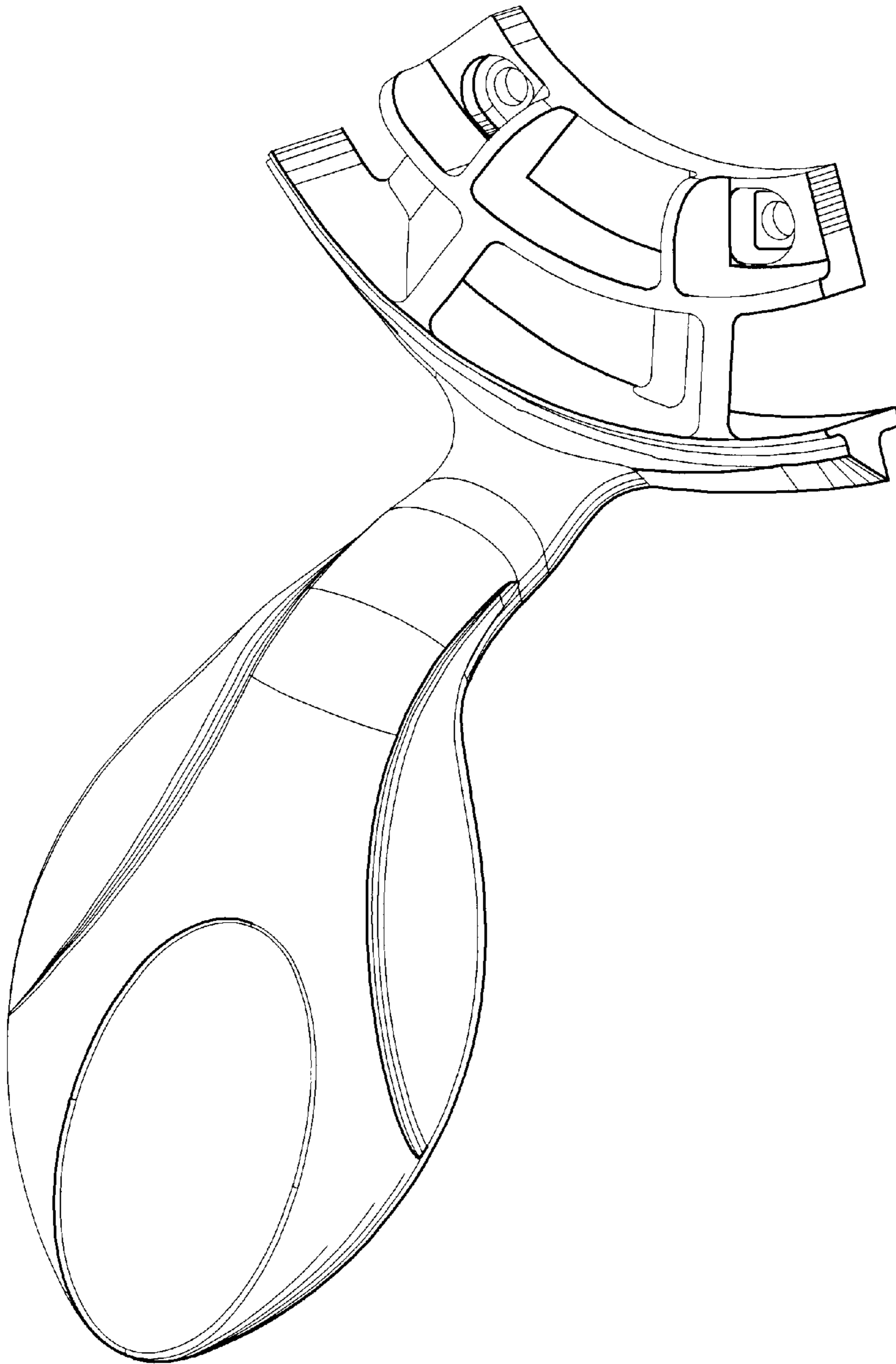

Fig. 2

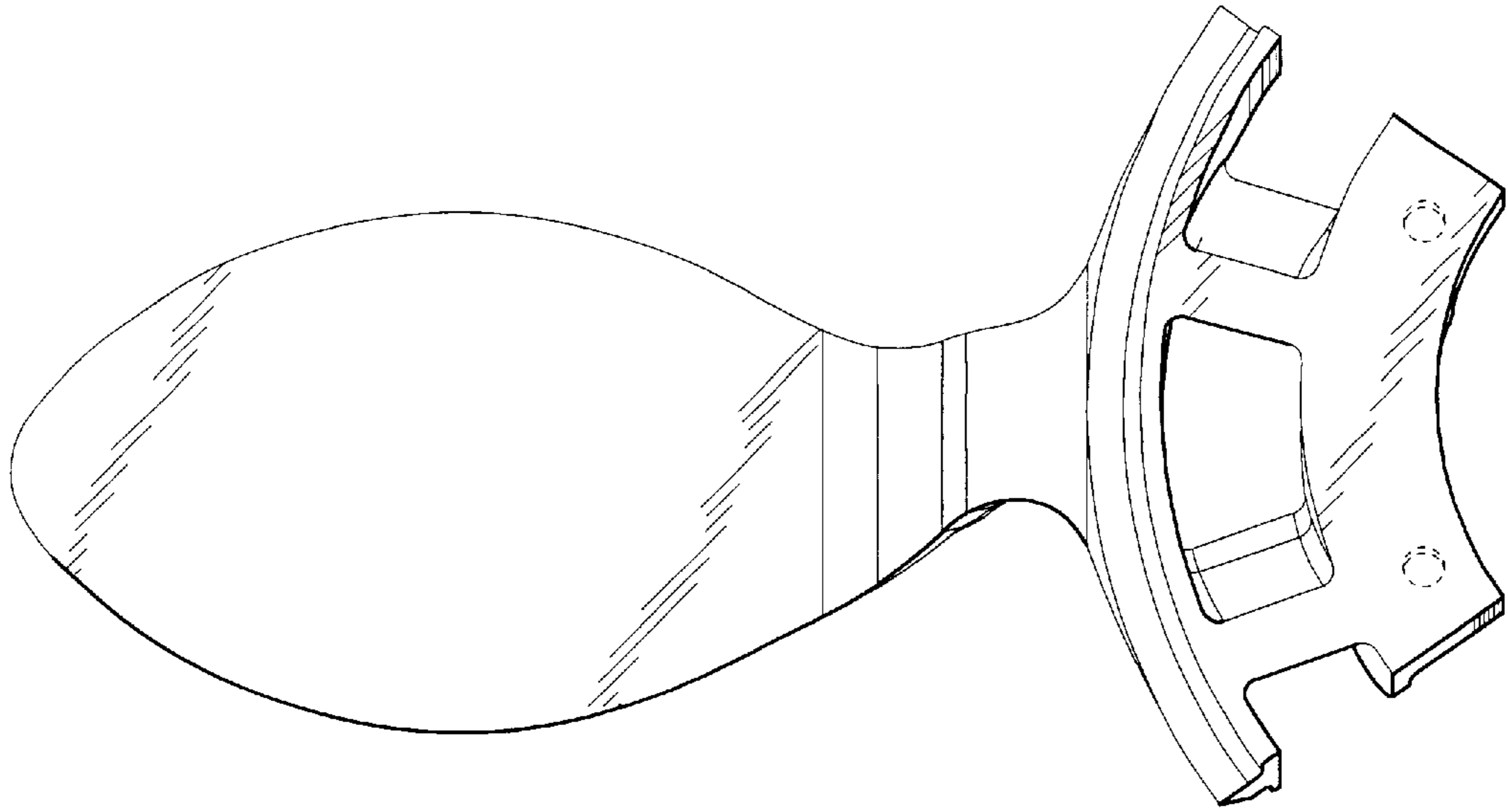

Fig. 3

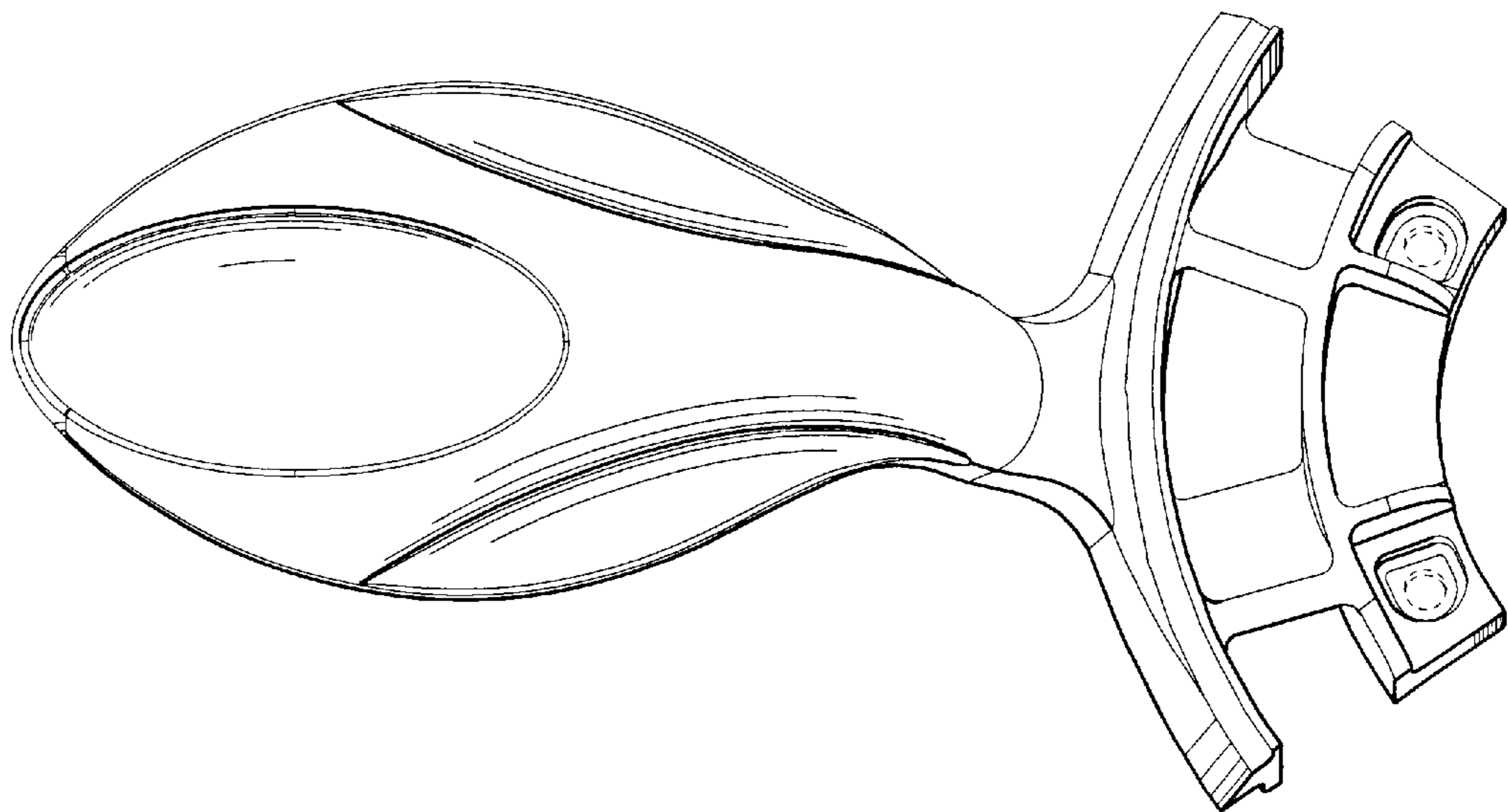

Fig. 4

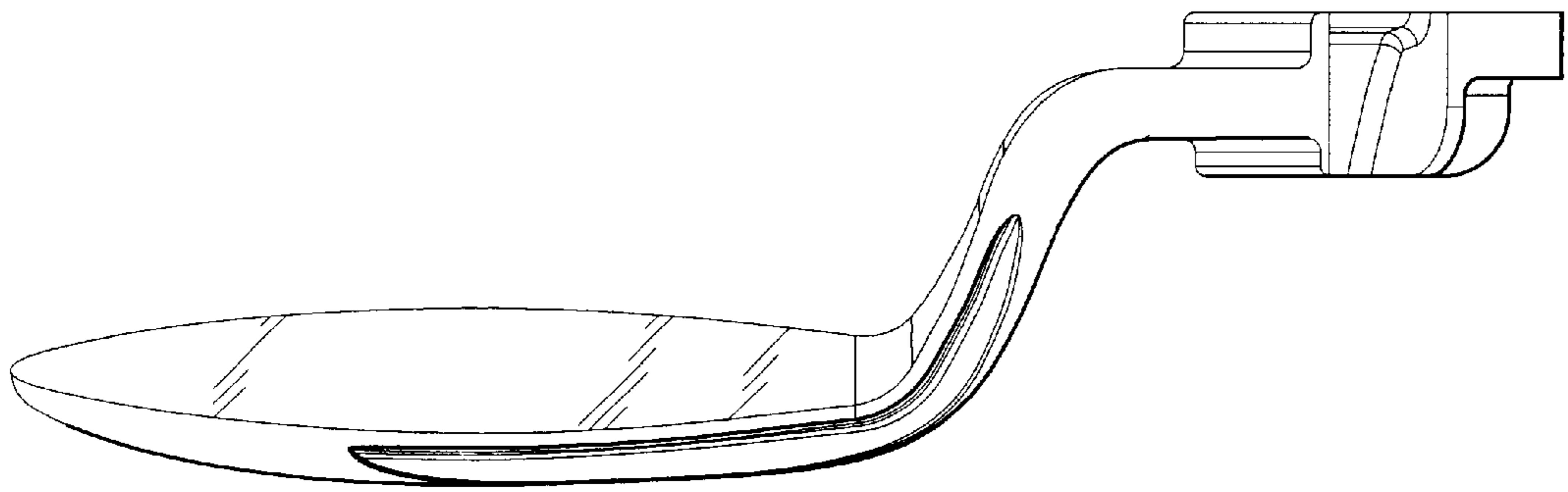

Fig. 5

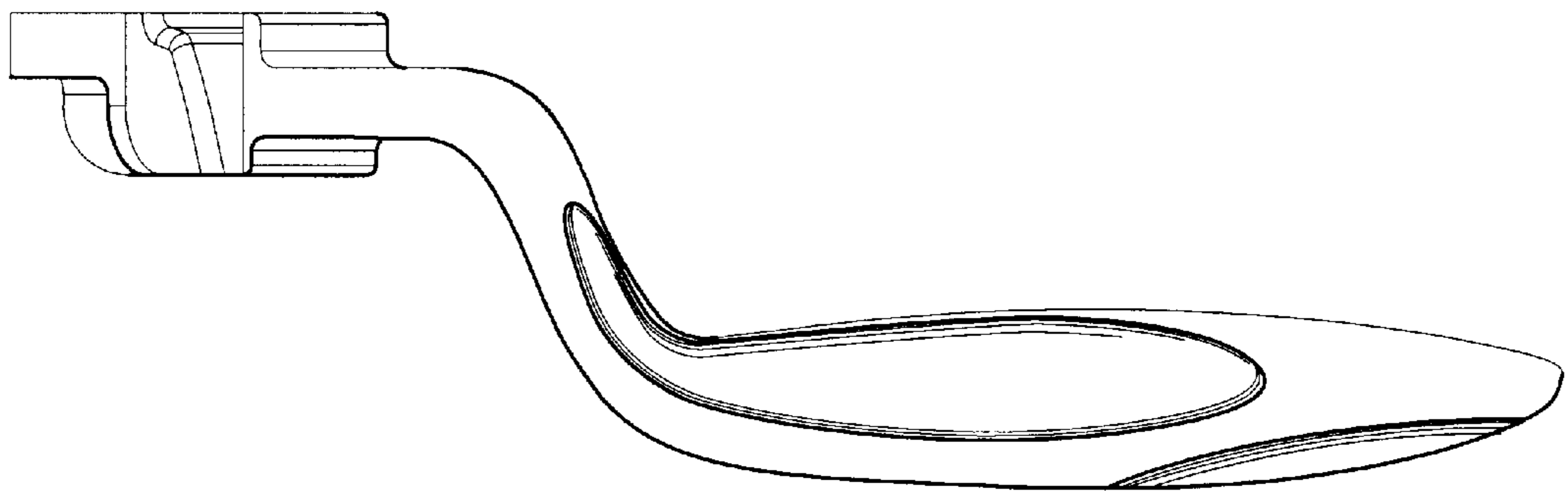

Fig. 6

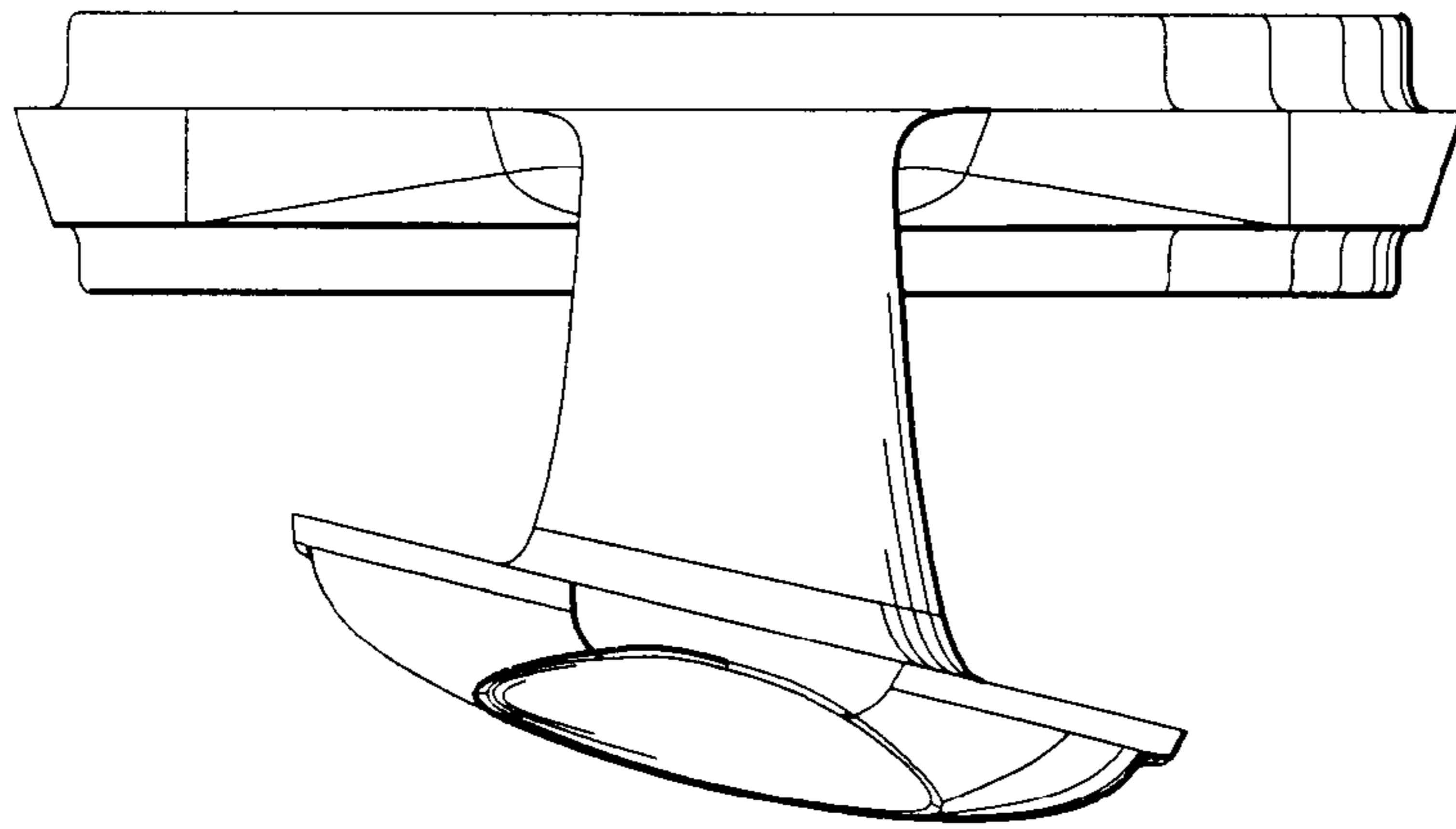

Fig. 7

