



US00D482688S

(12) **United States Design Patent**
Jung

(10) **Patent No.:** **US D482,688 S**

(45) **Date of Patent:** **** Nov. 25, 2003**

(54) **COMPUTER MONITOR**

(75) Inventor: **Hyun Jung**, Ansan (KR)

(73) Assignee: **Trigem Computer, Inc.** (KR)

(**) Term: **14 Years**

(21) Appl. No.: **29/168,435**

(22) Filed: **Oct. 2, 2002**

(30) **Foreign Application Priority Data**

Aug. 9, 2002 (KR) 2002-22762

(51) **LOC (7) Cl.** **14-02**

(52) **U.S. Cl.** **D14/375**

(58) **Field of Search** D14/371-382,
D14/125-129; 248/917-924; 341/12; 345/104,
156, 168, 173, 87; 348/180, 184, 325, 739;
349/1, 2, 11, 62

(56) **References Cited**

U.S. PATENT DOCUMENTS

D391,934 S * 3/1998 Uehara et al. D14/375

D416,549 S * 11/1999 Coster et al. D14/375

D448,769 S * 10/2001 Jung D14/374

* cited by examiner

Primary Examiner—Freda Nunn

(74) *Attorney, Agent, or Firm*—McKee, Voorhees & Sease,
P.L.C.

(57) **CLAIM**

I claim the ornamental design for a computer monitor, as shown and described.

DESCRIPTION

FIG. 1 is a perspective view of a computer monitor showing my new design.

FIG. 2 is a front elevational view thereof.

FIG. 3 is a rear elevational view thereof.

FIG. 4 is a left side elevational view thereof.

FIG. 5 is a right side elevational view thereof.

FIG. 6 is a top plan view thereof; and,

FIG. 7 is a bottom plan view thereof.

1 Claim, 4 Drawing Sheets

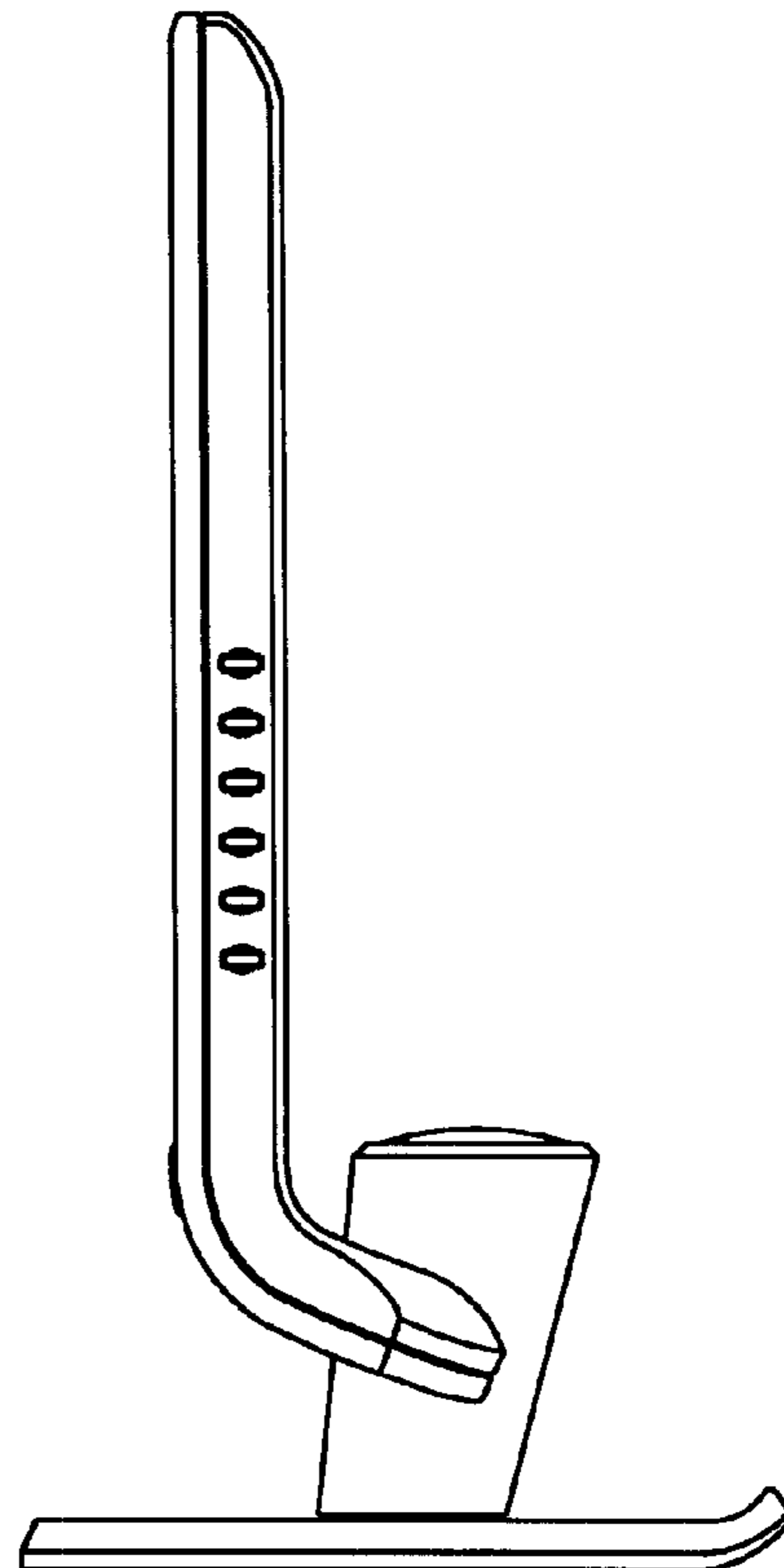
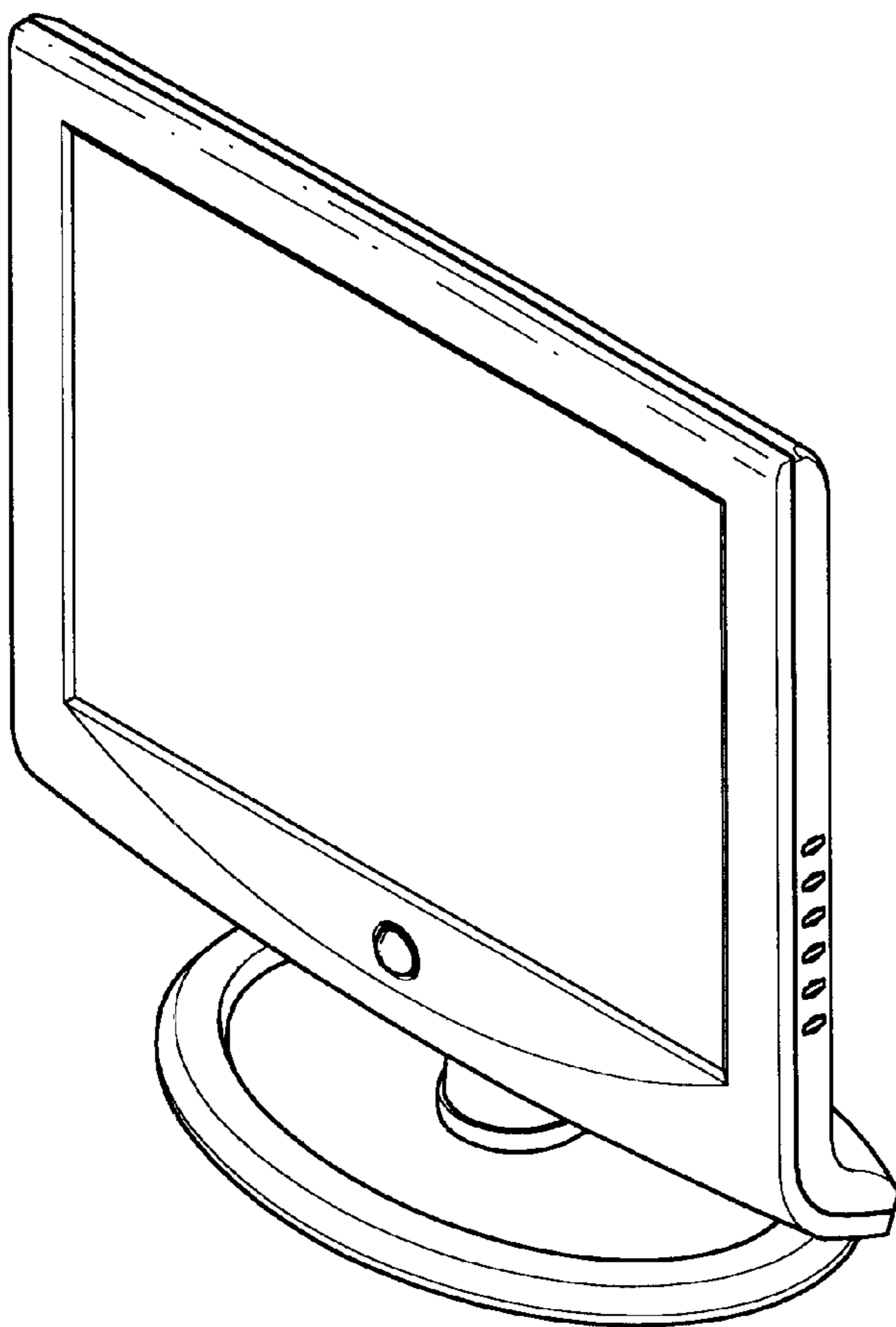

FIG. 1

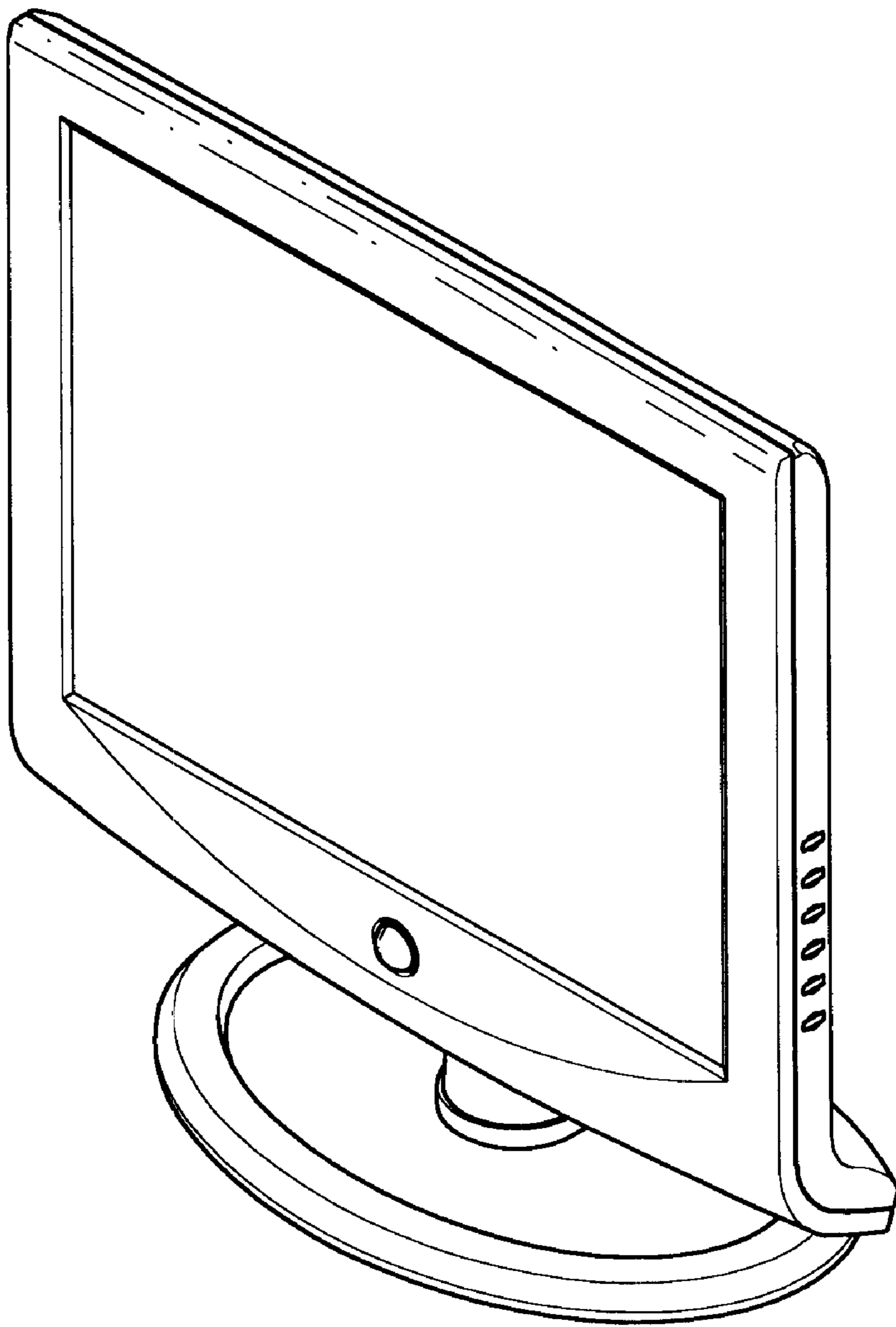

FIG.2

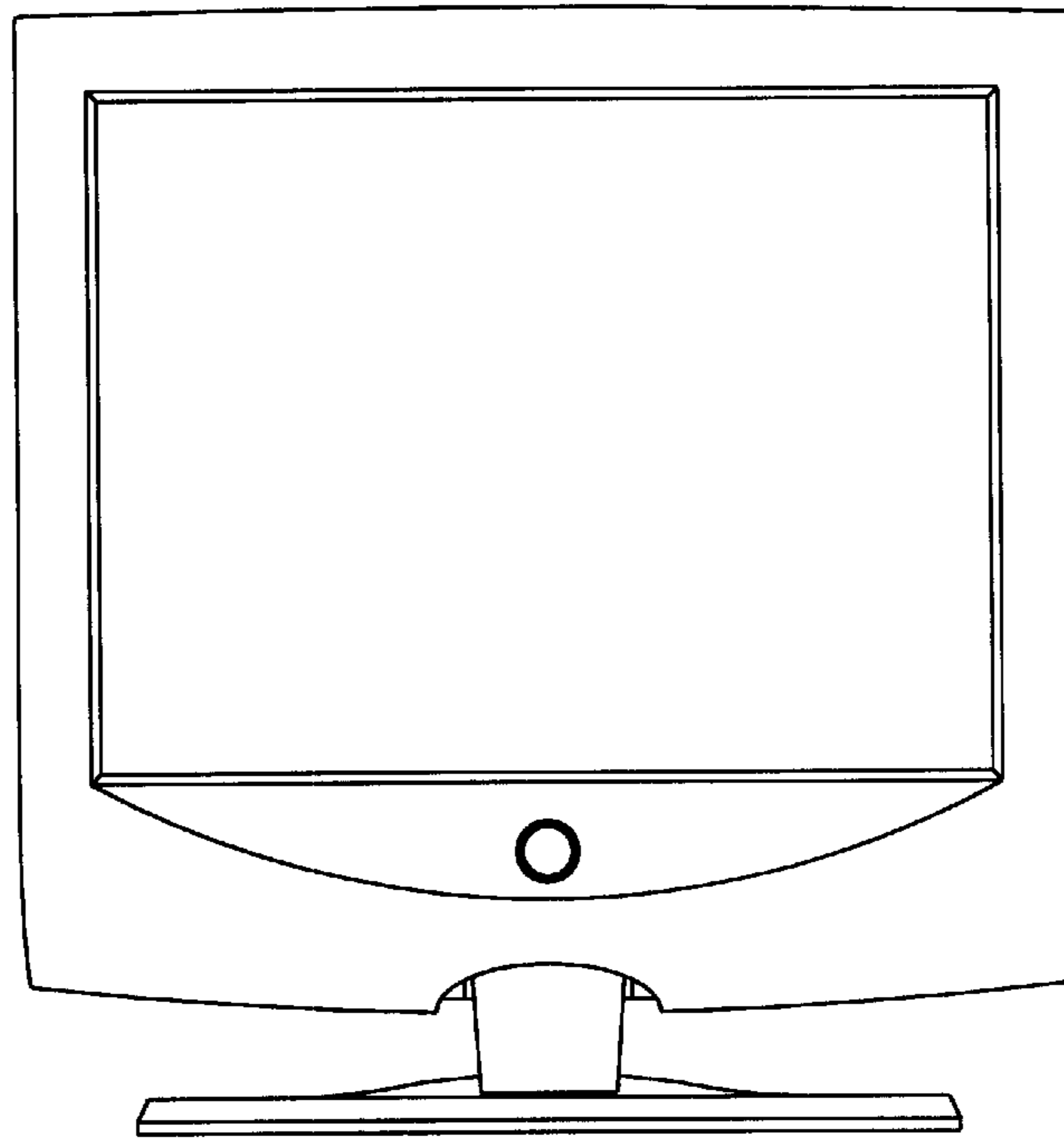

FIG.3

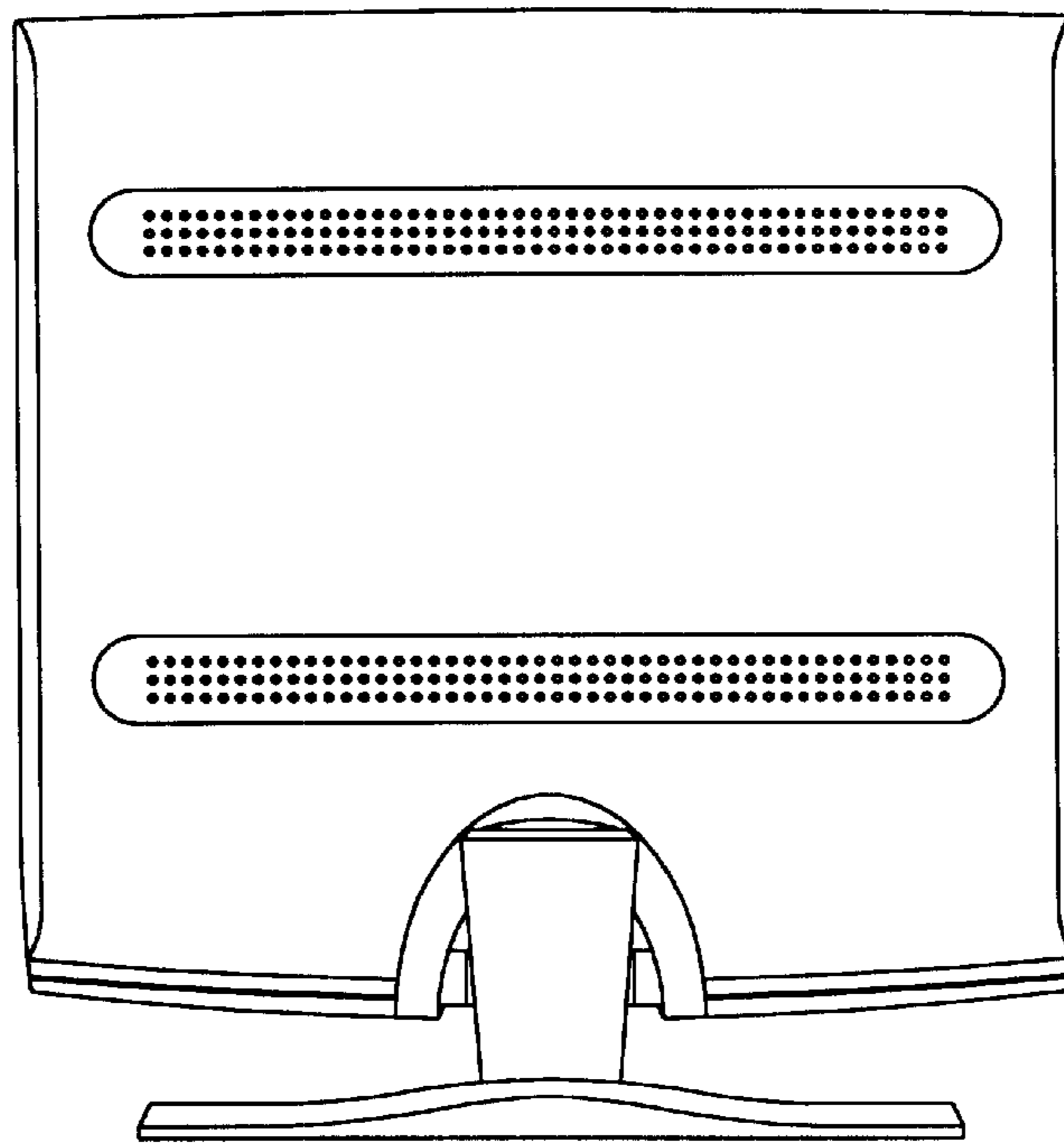

FIG. 4

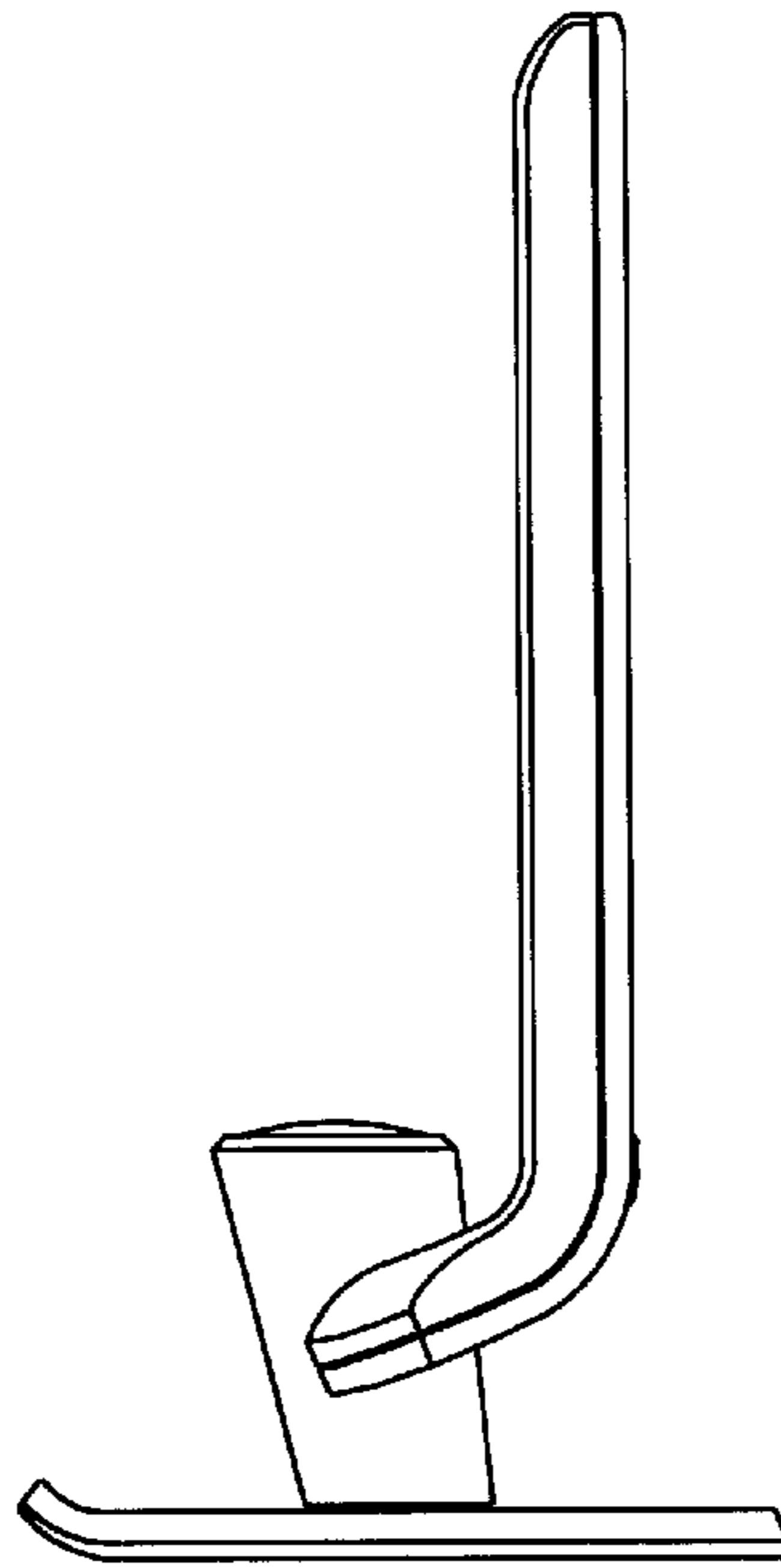

FIG. 5

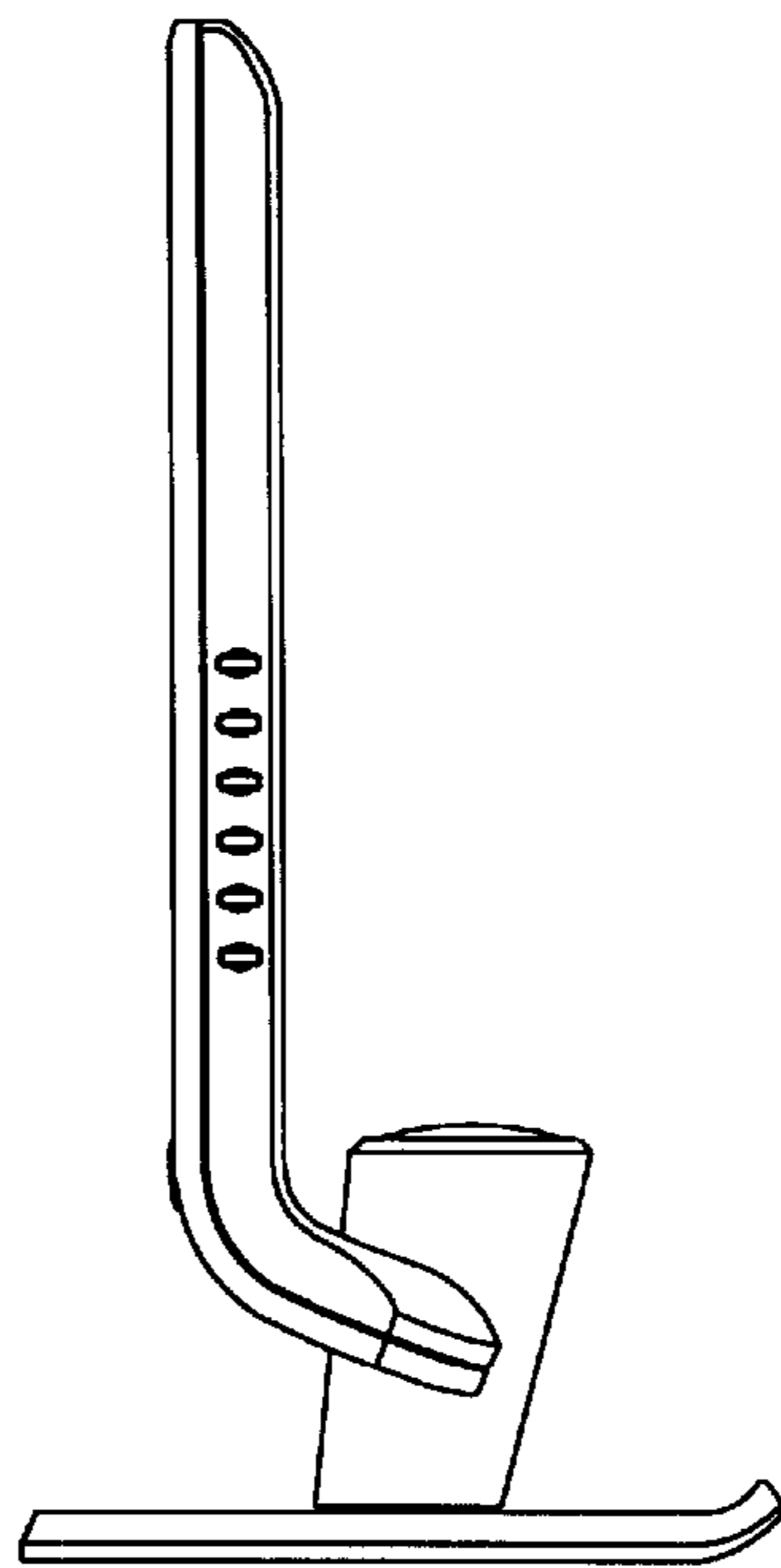

FIG.6

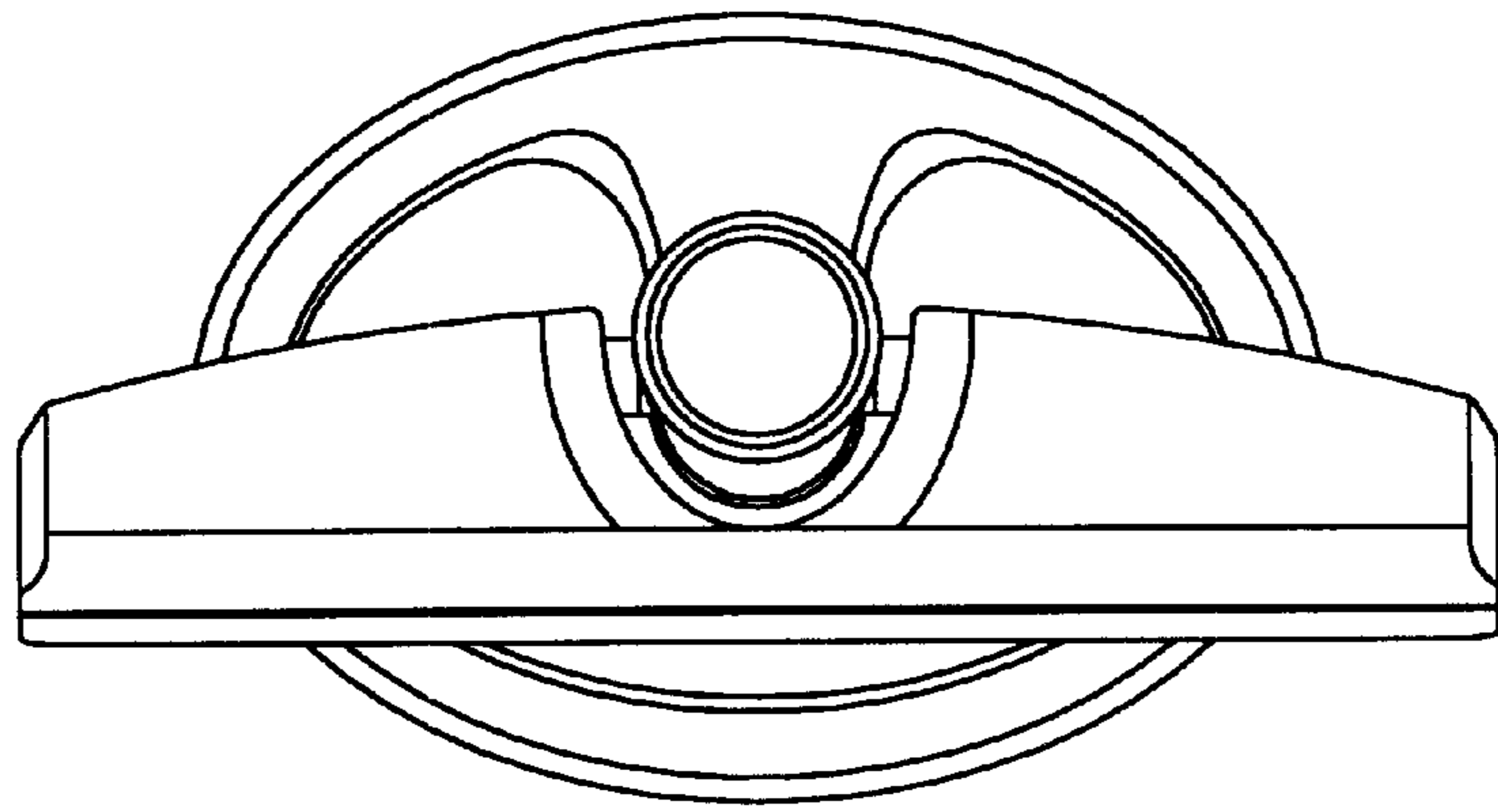

FIG.7

