



US00D482667S

(12) **United States Design Patent**
Yu

(10) **Patent No.:** **US D482,667 S**

(45) **Date of Patent:** **** Nov. 25, 2003**

(54) **RECEPTACLE**

(76) Inventor: **Jeff Yu**, 1101 S. Winchester Blvd.
#D146, San Jose, CA (US) 95128

(**) Term: **14 Years**

(21) Appl. No.: **29/171,616**

(22) Filed: **Nov. 26, 2002**

(51) **LOC (7) Cl.** **13-03**

(52) **U.S. Cl.** **D13/184**

(58) **Field of Search** D13/133, 147,
D13/152, 158, 164, 184; D14/240, 356;
220/3.2, 3.8, 3.94, 305, 810, 369; 307/10.1;
361/271, 274.3, 600-679, 683, 685, 692,
696, 709, 724, 730, 735, 736, 752, 763,
784, 796, 816, 829; 439/76.1, 300

(56) **References Cited**

U.S. PATENT DOCUMENTS

4,531,794 A * 7/1985 Heverly 439/147
4,801,035 A * 1/1989 Sugiyama et al. 220/3.8
4,959,018 A * 9/1990 Yamamoto et al. 439/76.1
D319,044 S * 8/1991 Kahan D13/162
5,038,050 A * 8/1991 Minoura 307/10.1
D332,088 S * 12/1992 Nimpoeno et al. D13/184

5,675,194 A * 10/1997 Domigan 307/147
5,903,438 A * 5/1999 Deschamps et al. 361/736
D426,192 S * 6/2000 Rathbun et al. D13/147

* cited by examiner

Primary Examiner—Philip S. Hyder

Assistant Examiner—Selina Sikder

(57) **CLAIM**

The ornamental design for a receptacle, as shown and described.

DESCRIPTION

FIG. 1 is a front perspective view of a receptacle in its closed position;

FIG. 2 is a front elevational view thereof;

FIG. 3 is a rear elevational view thereof;

FIG. 4 is a top view thereof;

FIG. 5 is bottom view thereof;

FIG. 6 is a right elevational view thereof;

FIG. 7 is a left elevational view thereof; and,

FIG. 8 is a left elevational view thereof in its opened position.

The broken line showing of the environment is for illustrative purposes only and forms no part of the claimed design.

1 Claim, 4 Drawing Sheets

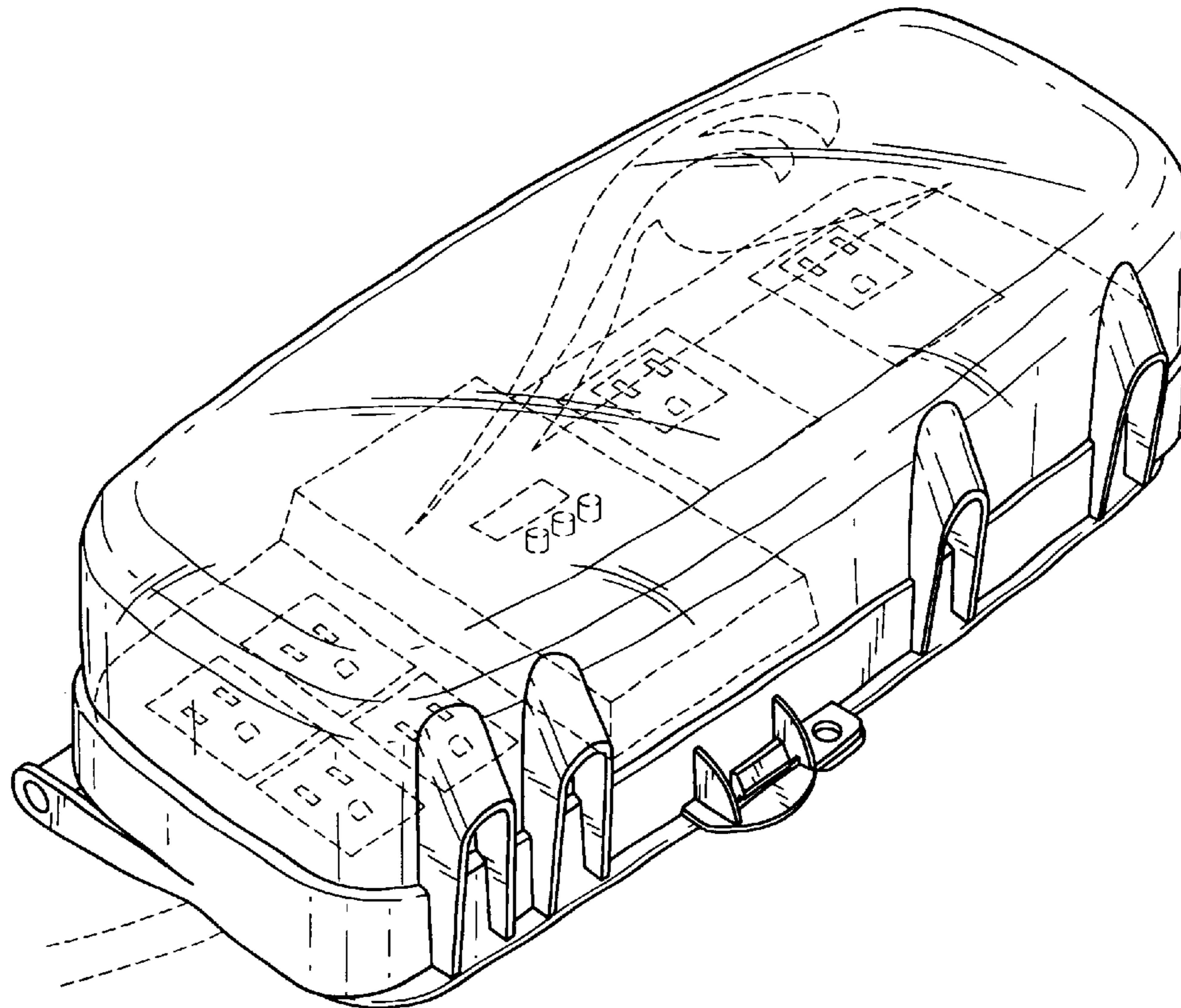

FIG. 1

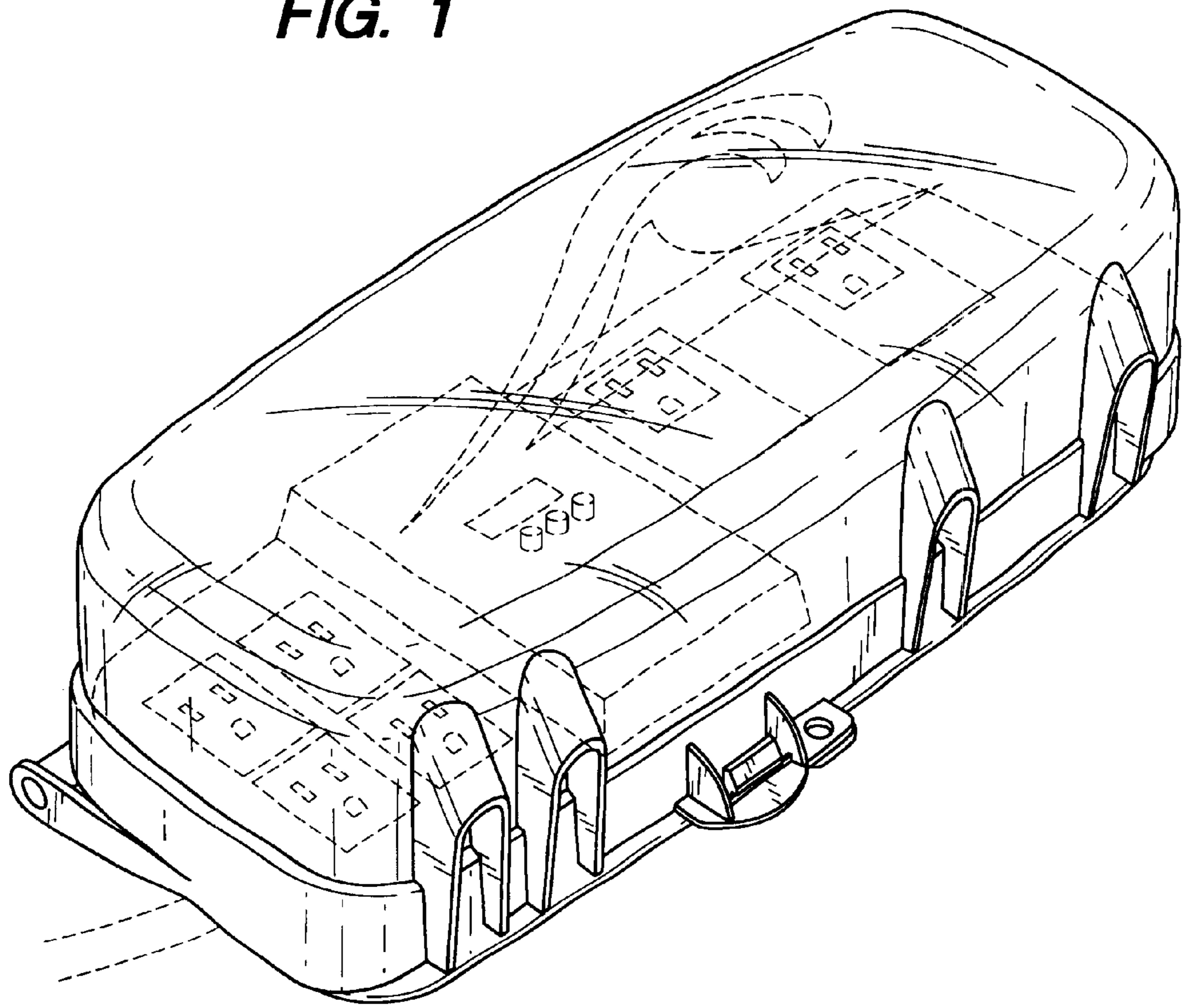

FIG. 2

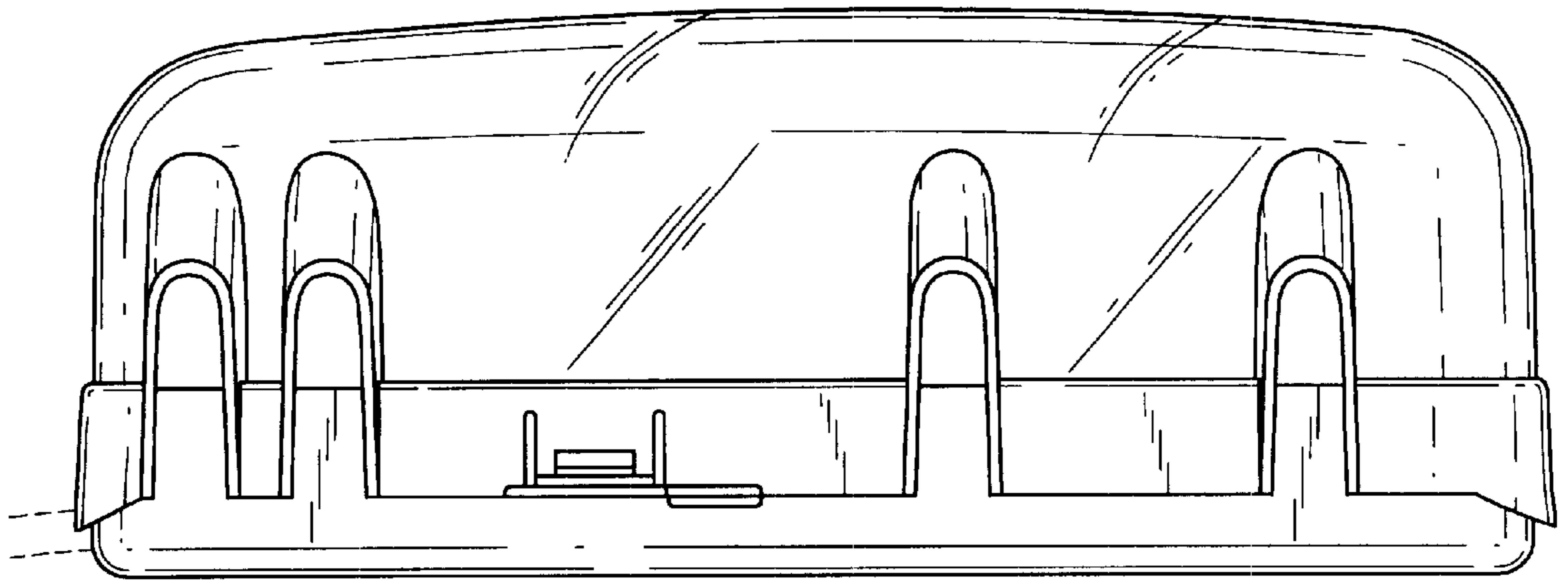

FIG. 3

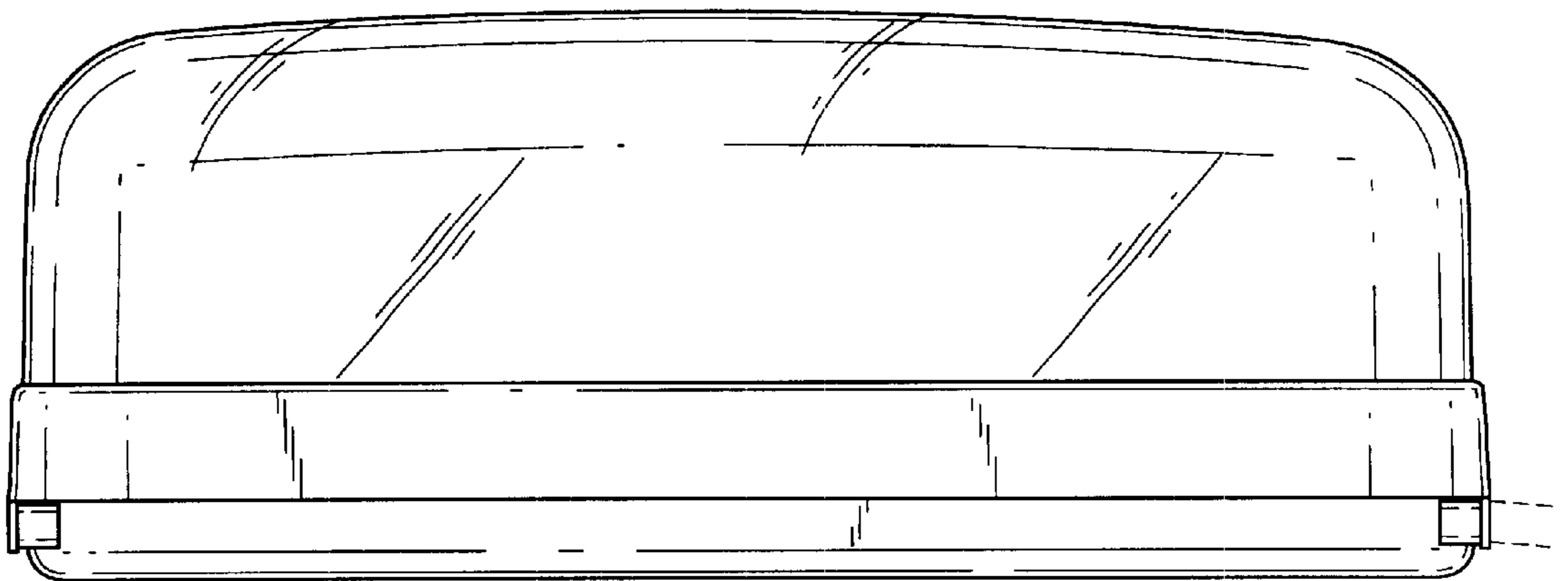

FIG. 4

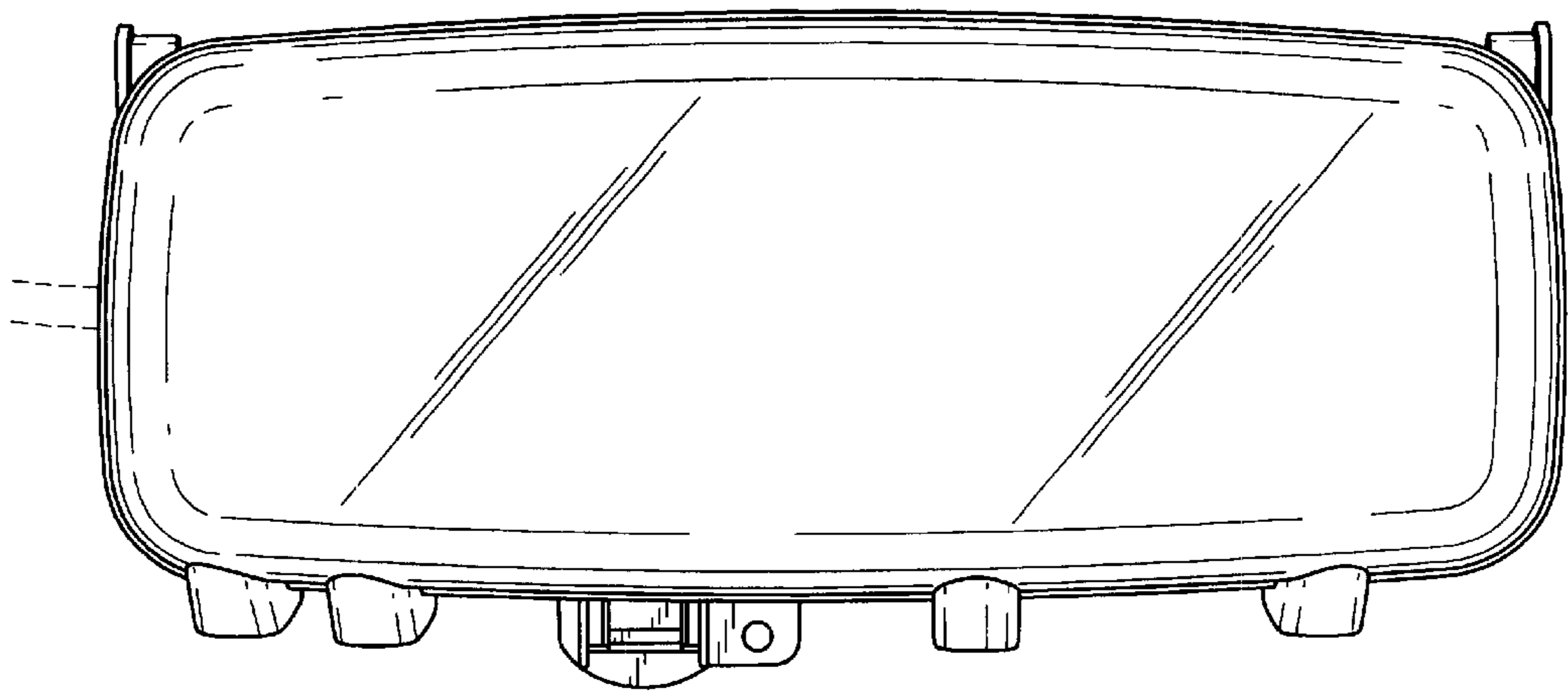

FIG. 5

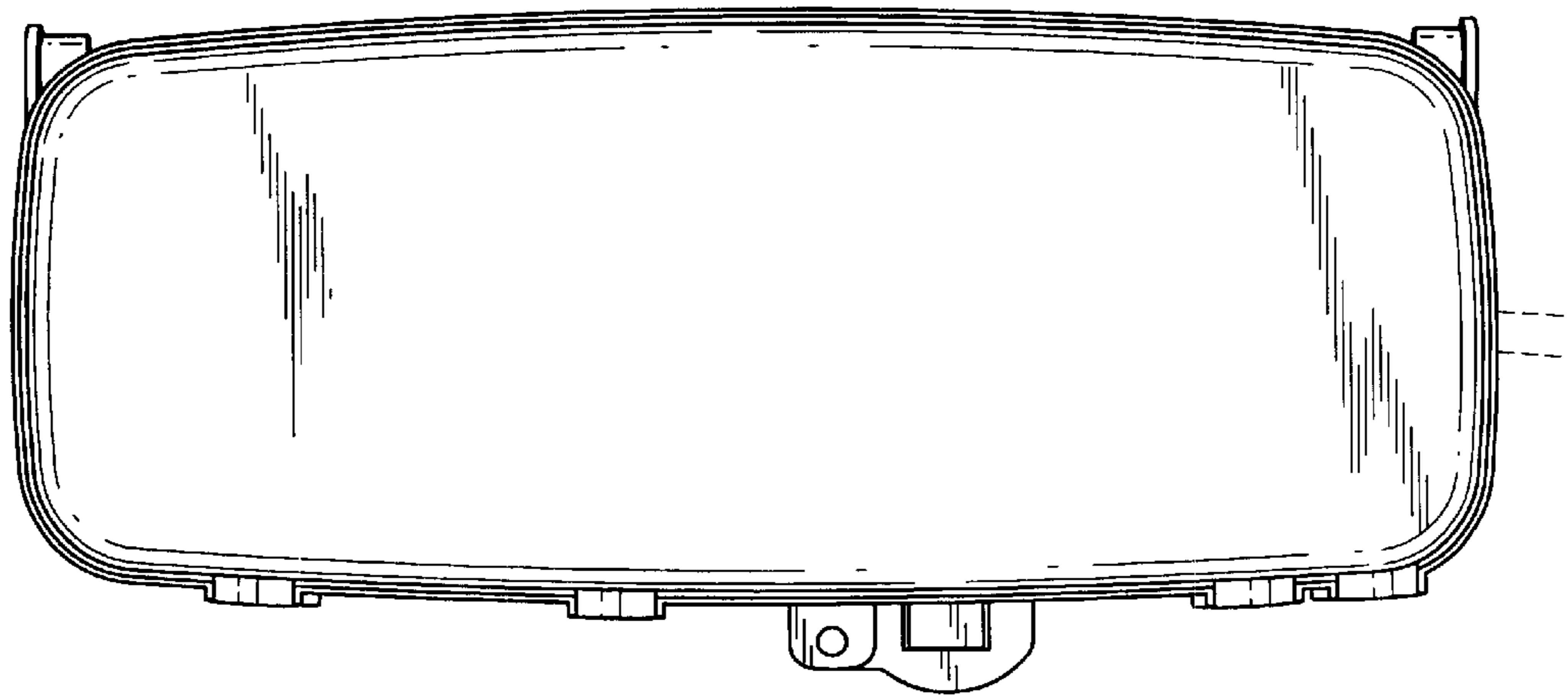

FIG. 6

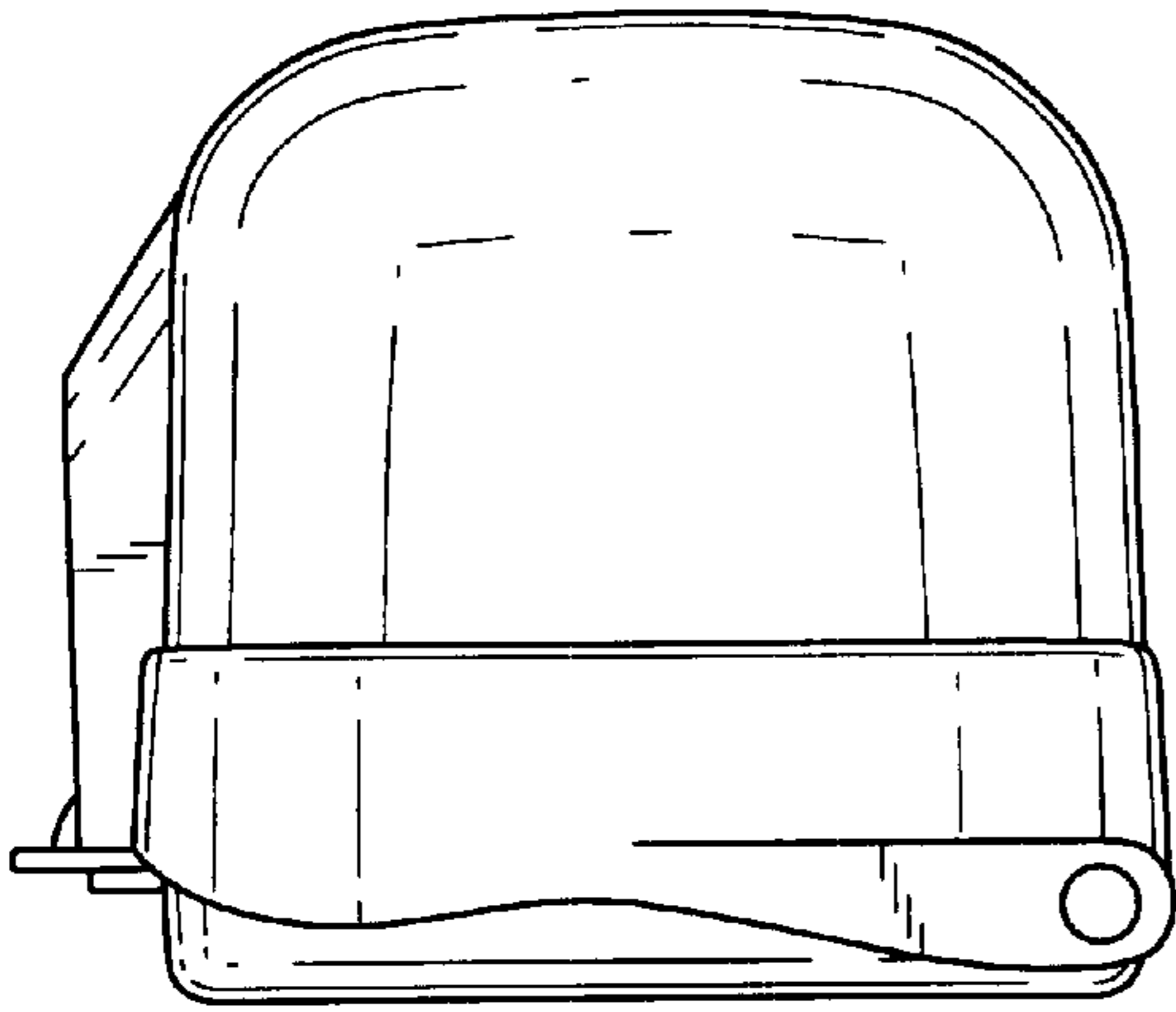

FIG. 7

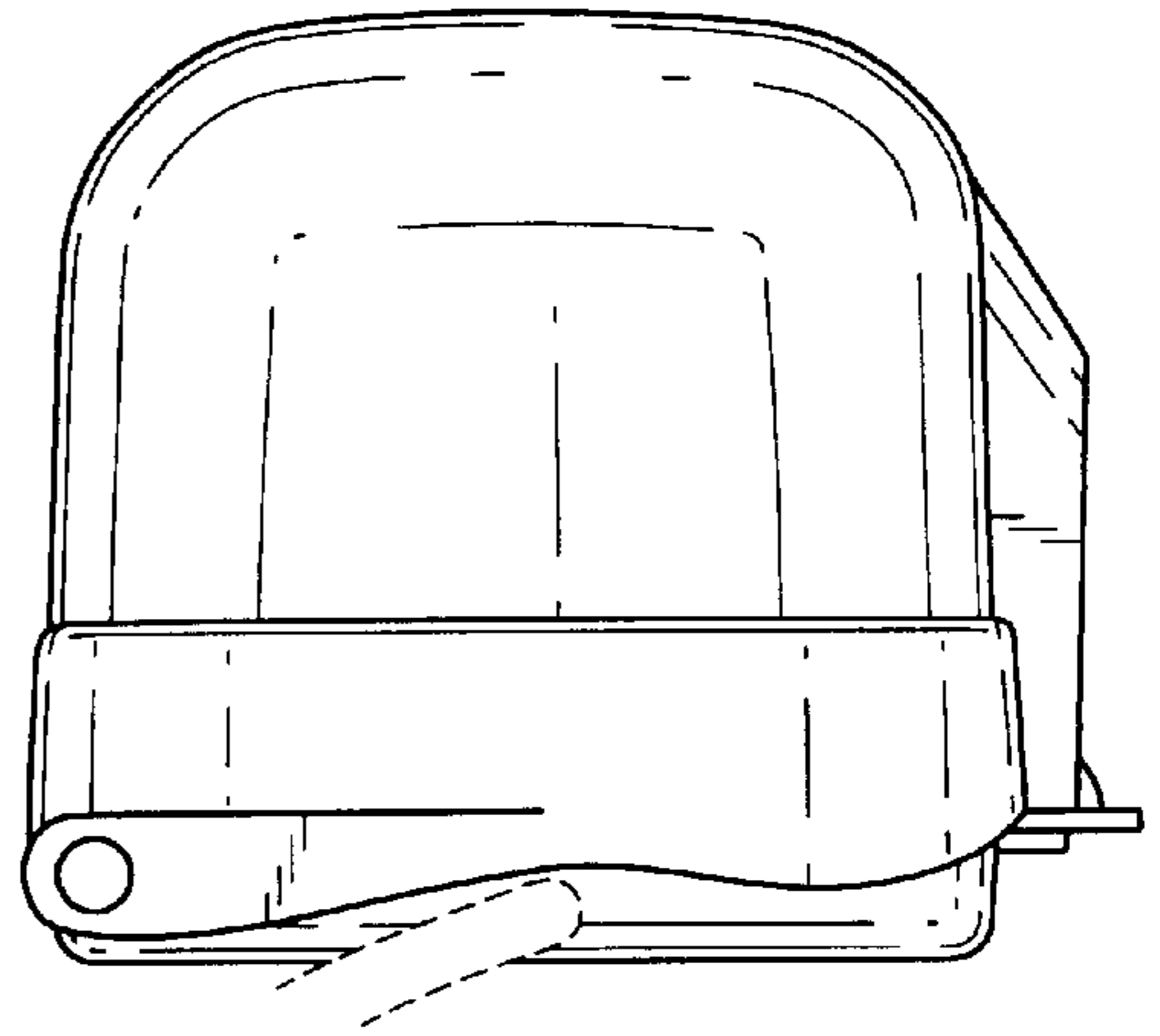

FIG. 8

