



US00D482586S

(12) **United States Design Patent**
Puerta

(10) **Patent No.:** **US D482,586 S**

(45) **Date of Patent:** **** Nov. 25, 2003**

(54) **SCREWDRIVER**

6,502,484 B2 1/2003 Pao-Hsi 81/439
6,508,156 B1 1/2003 Wei 81/490

(75) Inventor: **David V. Puerta**, Colorado Springs, CO
(US)

* cited by examiner

(73) Assignee: **Emerson Electric Co.**, St. Louis, MO
(US)

Primary Examiner—Philip S. Hyder
(74) *Attorney, Agent, or Firm*—Ira D. Finkelstein; Howrey
Simon Arnold & White, LLP

(**) Term: **14 Years**

(57) **CLAIM**

(21) Appl. No.: **29/173,416**

The ornamental design for a screwdriver, as shown and
described herein.

(22) Filed: **Dec. 27, 2002**

DESCRIPTION

(51) **LOC (7) Cl.** **08-04**

(52) **U.S. Cl.** **D8/82; D8/83; D8/85**

(58) **Field of Search** D8/82, 83, 84,
D8/85, 86, 87, 107; 81/177.1, 177.5, 177.8,
436, 439, 489; 7/165

FIG. 1 is a perspective view of the screwdriver of the present
invention with an interchangeable shaft inserted in the
transverse socket of the handle.

FIG. 2 is a perspective elevational view of the same screw-
driver with the interchangeable shaft inserted in the axial
socket of the handle.

FIG. 3 is a front view of the screwdriver with the shaft in the
transverse socket of the handle.

FIG. 4 is a bottom view of the screwdriver with the shaft in
the transverse socket of the handle.

FIG. 5 is a rear view of the screwdriver with the shaft in the
transverse socket of the handle.

FIG. 6 is a top view of the screwdriver with the shaft in the
transverse socket of the handle.

FIG. 7 is a side view of the screwdriver with the shaft in the
transverse socket of the handle.

FIG. 8 is another side view of the screwdriver with the shaft
in the transverse socket of the handle.

FIG. 9 is a front view of the screwdriver with the shaft in the
axial socket of the handle.

FIG. 10 is a side view of the screwdriver with the shaft in
the axial socket of the handle.

FIG. 11 is a rear view showing the side opposite the side
depicted in FIG. 9.

FIG. 12 is an end view of the screwdriver with the shaft in
the axial socket of the handle; and,

FIG. 13 is another end view of the screwdriver with the shaft
in the axial socket of the handle.

The broken line showings of the bit are for illustrative
purposes only and form no part of the claimed design.

(56) **References Cited**

U.S. PATENT DOCUMENTS

| | | | | |
|-----------|----|-----------|------------------|----------|
| 463,507 | A | 11/1891 | Goodell | |
| D229,475 | S | * 12/1973 | Uboldi | D8/82 |
| 4,241,773 | A | 12/1980 | Personnat | |
| 4,552,044 | A | 11/1985 | Corona et al. | 81/490 |
| 4,640,155 | A | * 2/1987 | Condon | 81/439 |
| D298,101 | S | * 10/1988 | Chen | D8/85 |
| 4,924,733 | A | 5/1990 | McKenzie | 81/438 |
| 5,174,178 | A | 12/1992 | Disston, Jr. | 81/490 |
| D344,002 | S | * 2/1994 | McKinney et al. | D8/82 |
| D358,316 | S | 5/1995 | Markwart et al. | D8/82 |
| D383,660 | S | * 9/1997 | Anderson | D8/83 |
| D384,263 | S | * 9/1997 | Lin | D8/83 |
| 6,076,432 | A | 6/2000 | Chang | 81/61 |
| 6,209,428 | B1 | 4/2001 | Anderson et al. | 81/490 |
| 6,220,129 | B1 | 4/2001 | Shimansky | 81/490 |
| 6,237,451 | B1 | 5/2001 | Wei | 81/490 |
| 6,293,173 | B1 | 9/2001 | Rowlay | 81/490 |
| D448,642 | S | * 10/2001 | Hermann | D8/83 |
| 6,305,815 | B1 | 10/2001 | Lin | 362/119 |
| 6,327,942 | B1 | 12/2001 | Mariol et al. | 81/177.4 |
| 6,332,384 | B1 | 12/2001 | Cluthe | 81/490 |
| 6,378,402 | B1 | 4/2002 | Kalomeris et al. | 81/177.5 |
| 6,378,407 | B1 | 4/2002 | Purkapile | 81/490 |
| 6,443,037 | B1 | 9/2002 | Chang | 81/62 |

1 Claim, 6 Drawing Sheets

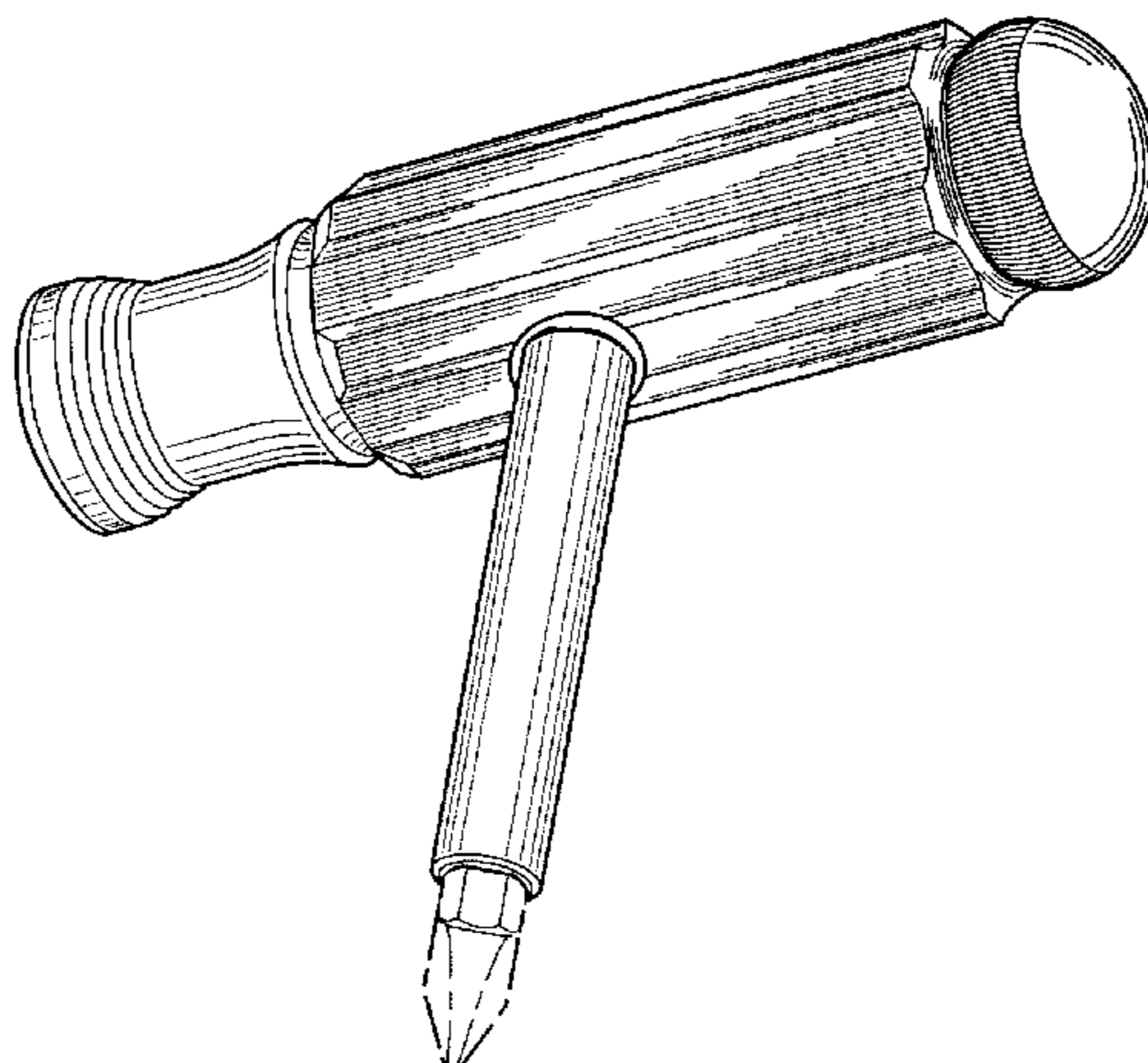

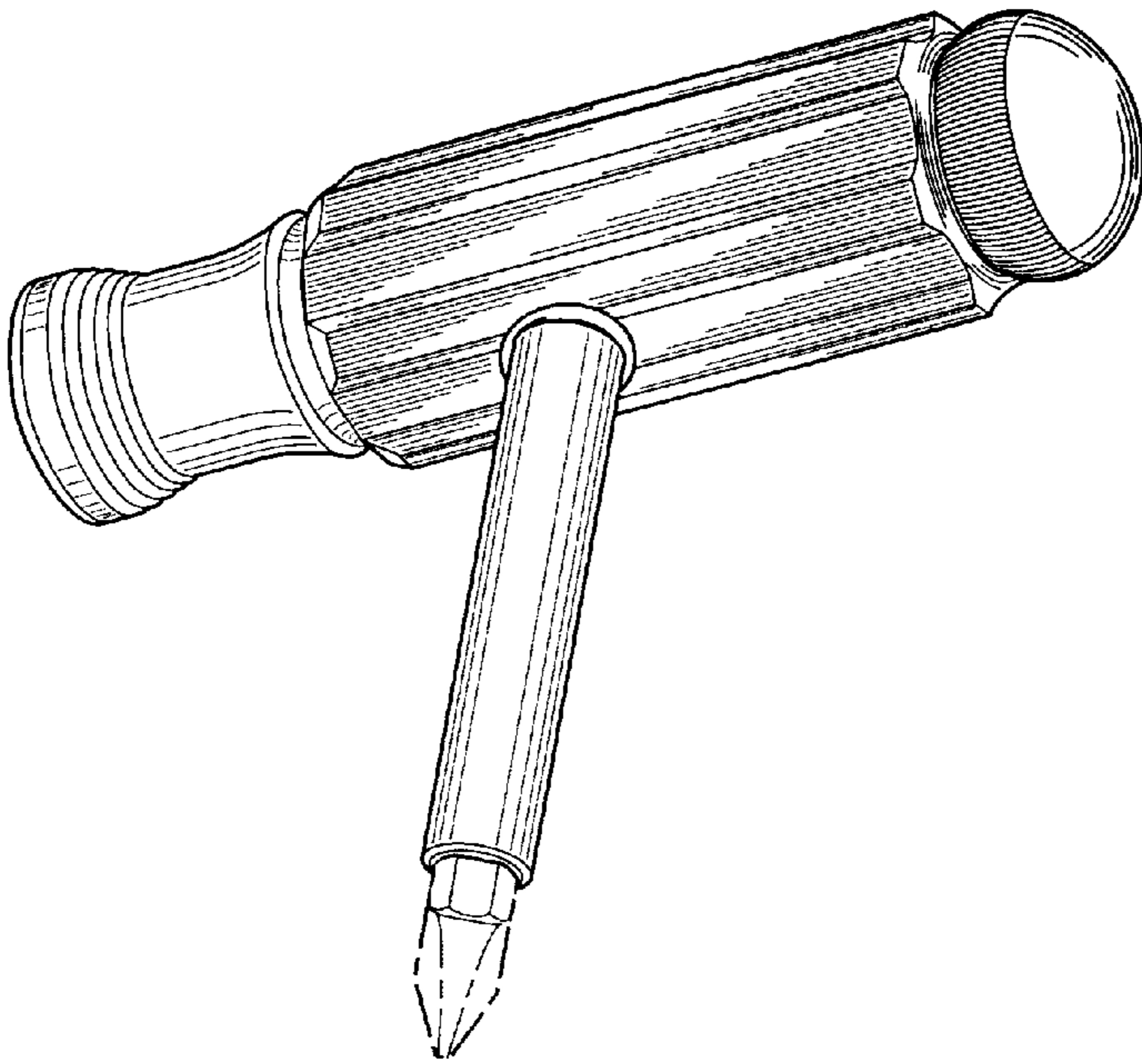

Figure 1

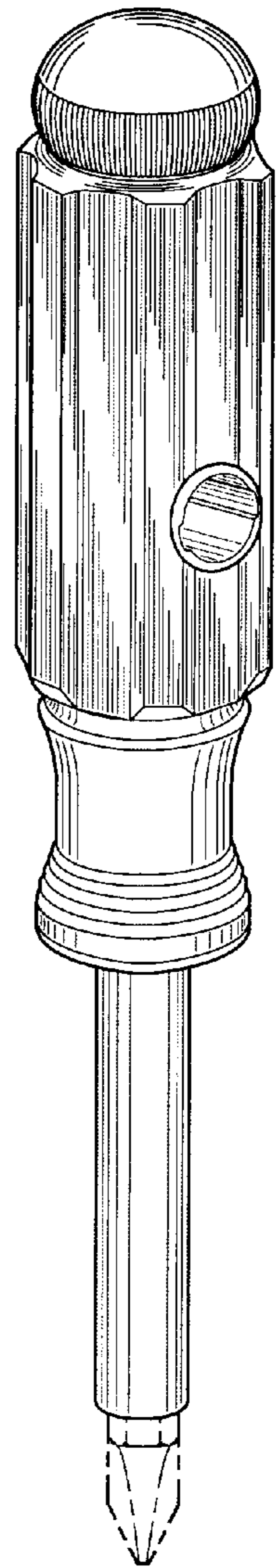

Figure 2

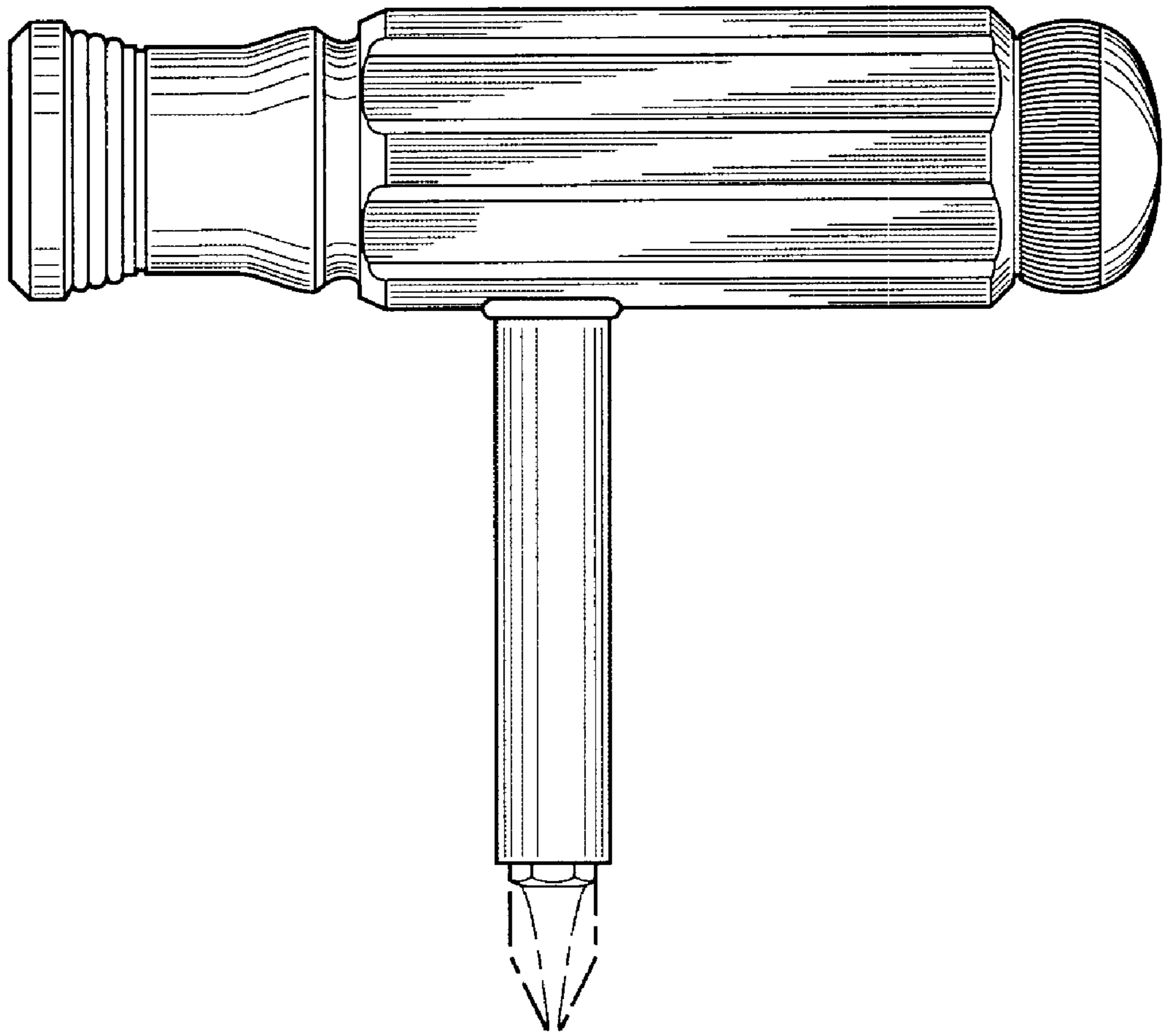

Figure 3

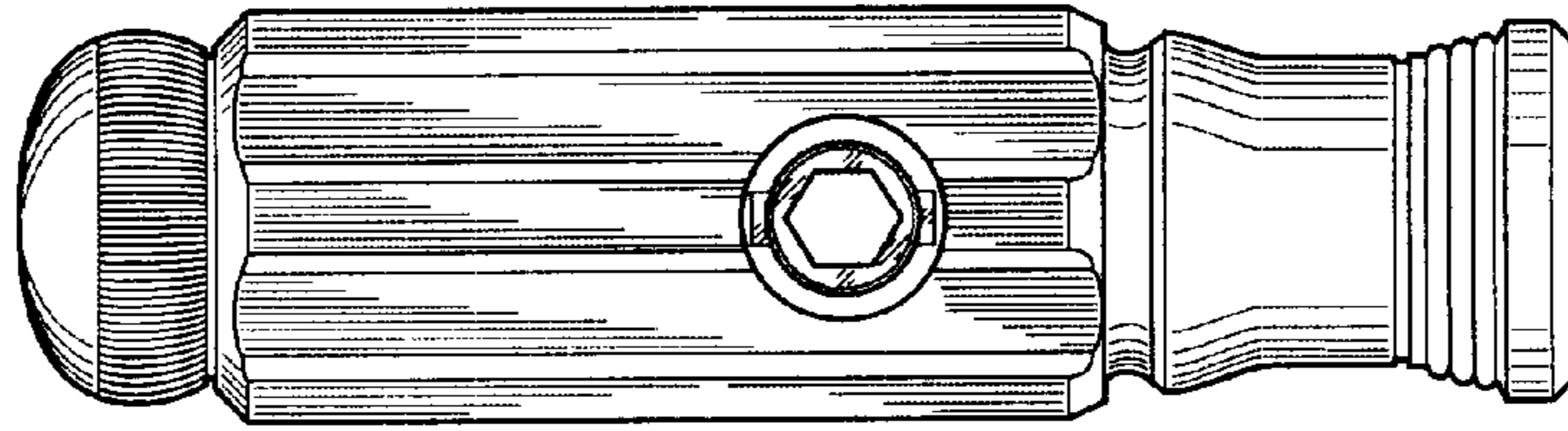

Figure 4

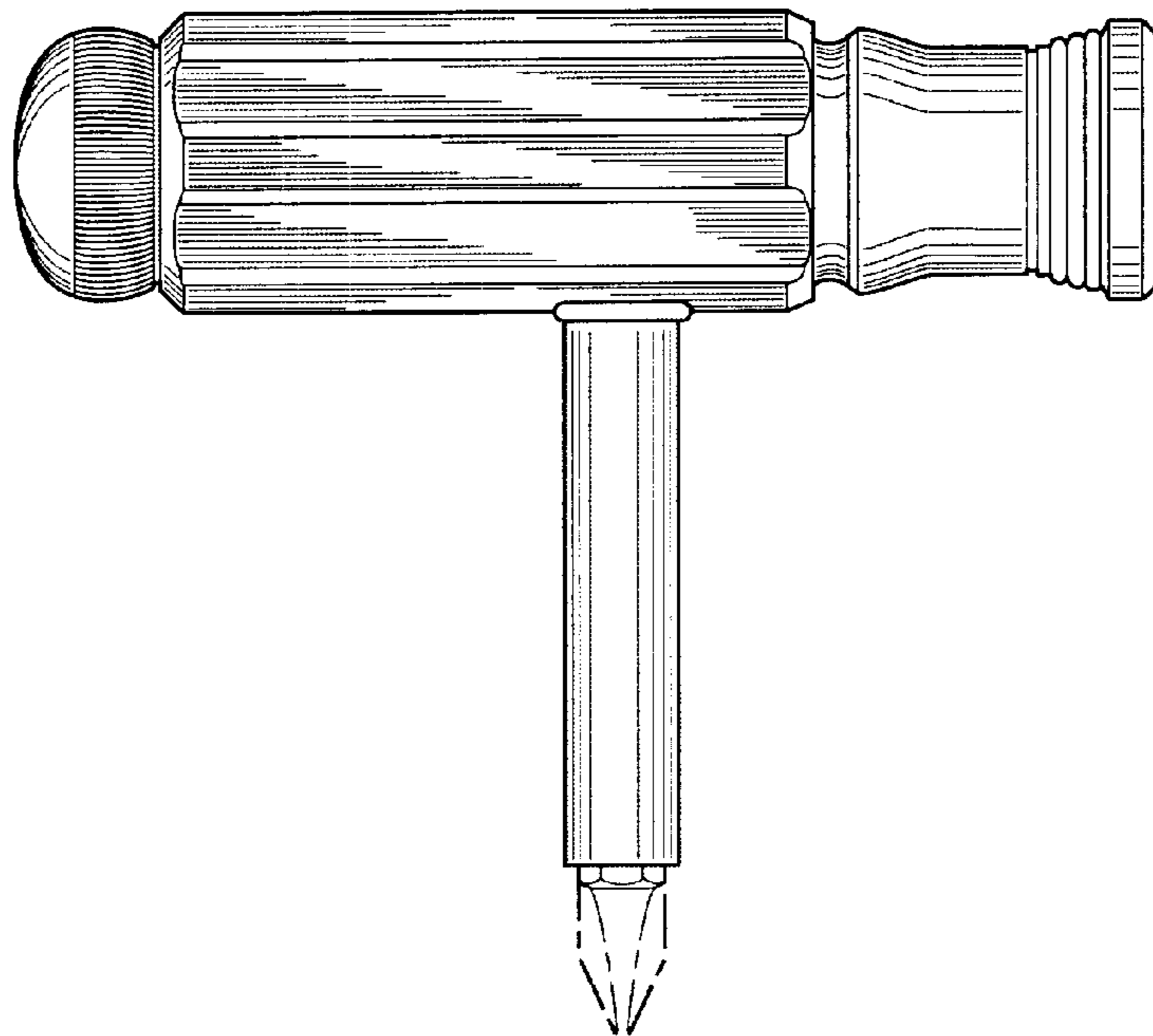

Figure 5

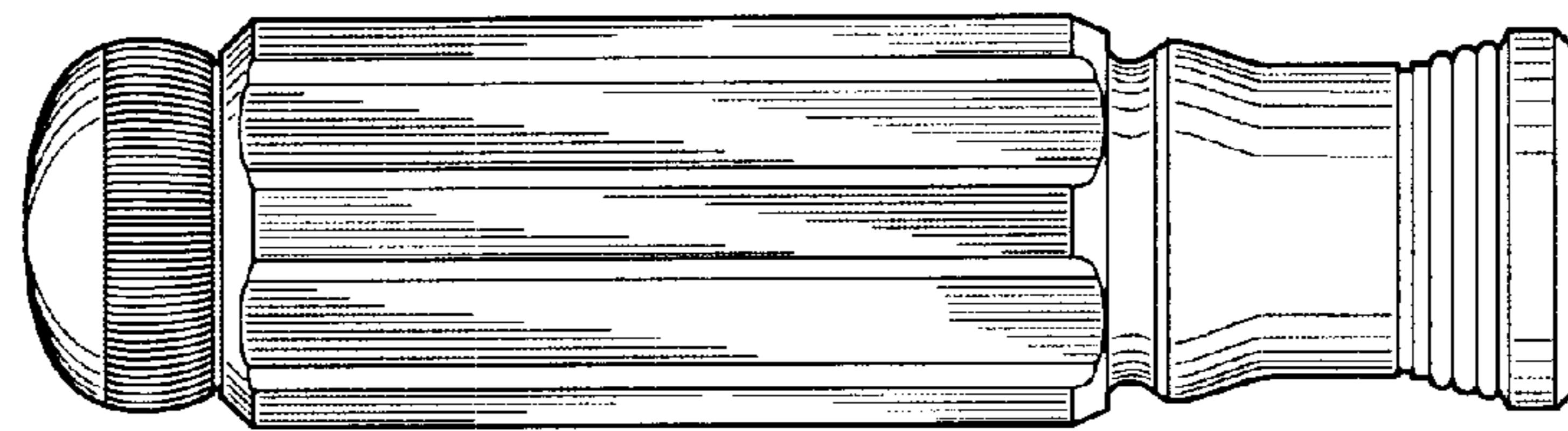

Figure 6

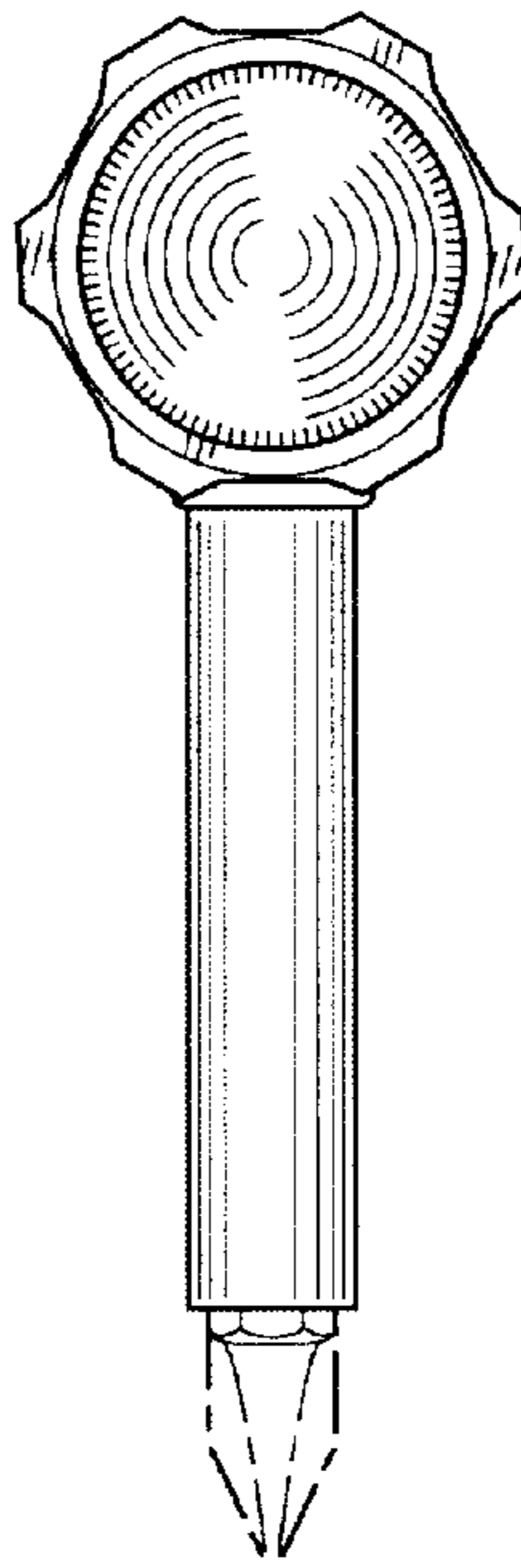

Figure 7

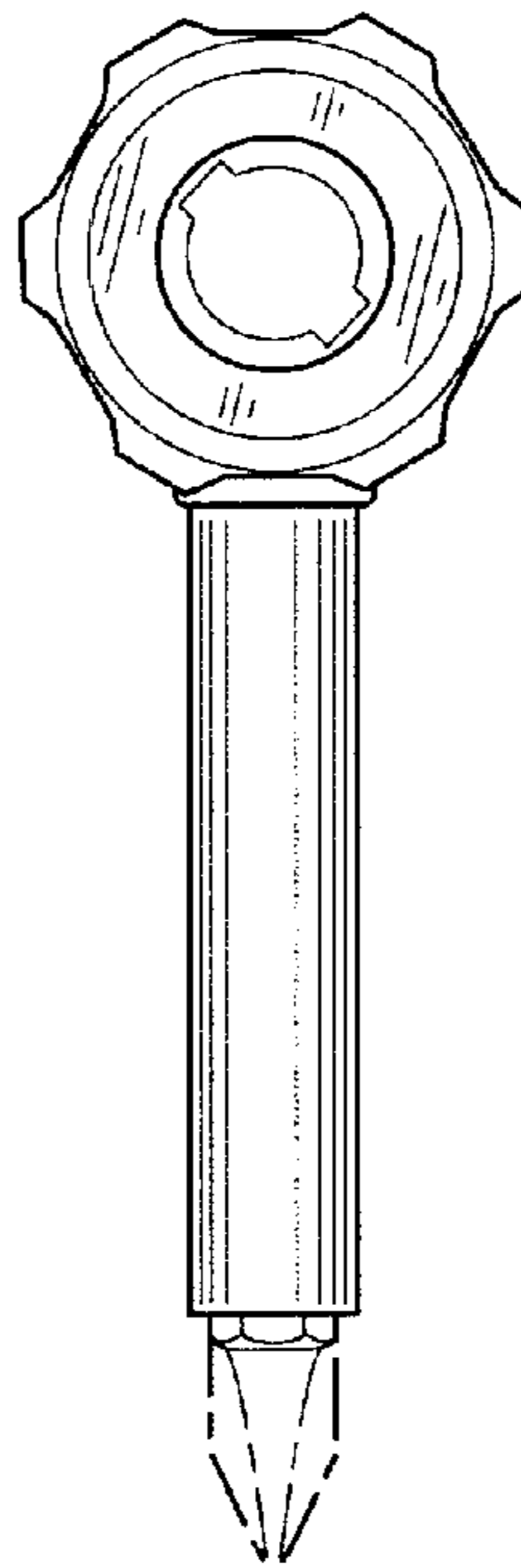

Figure 8

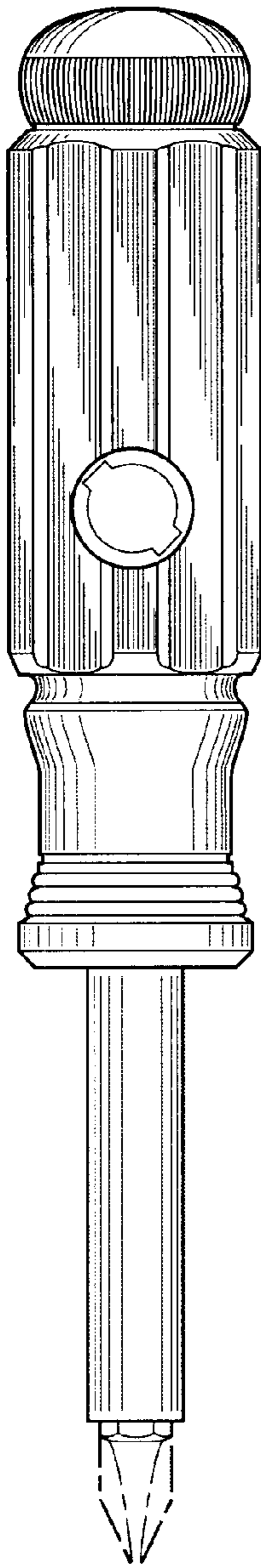

Figure 9

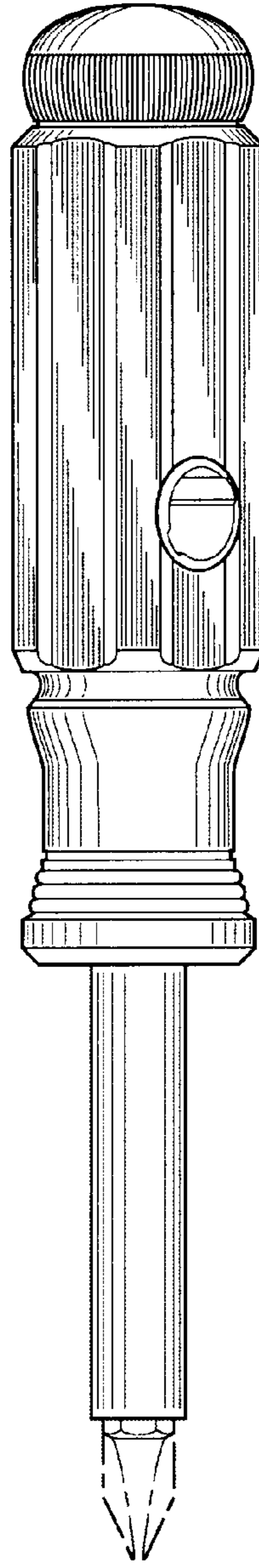

Figure 10

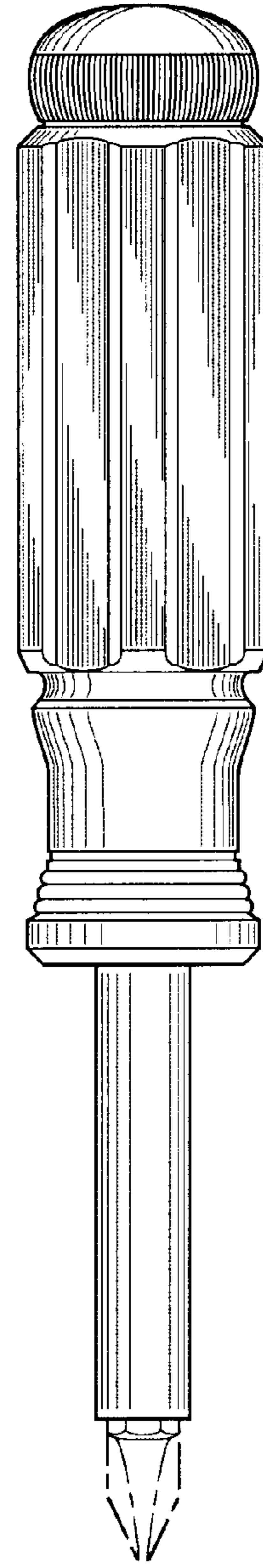

Figure 11

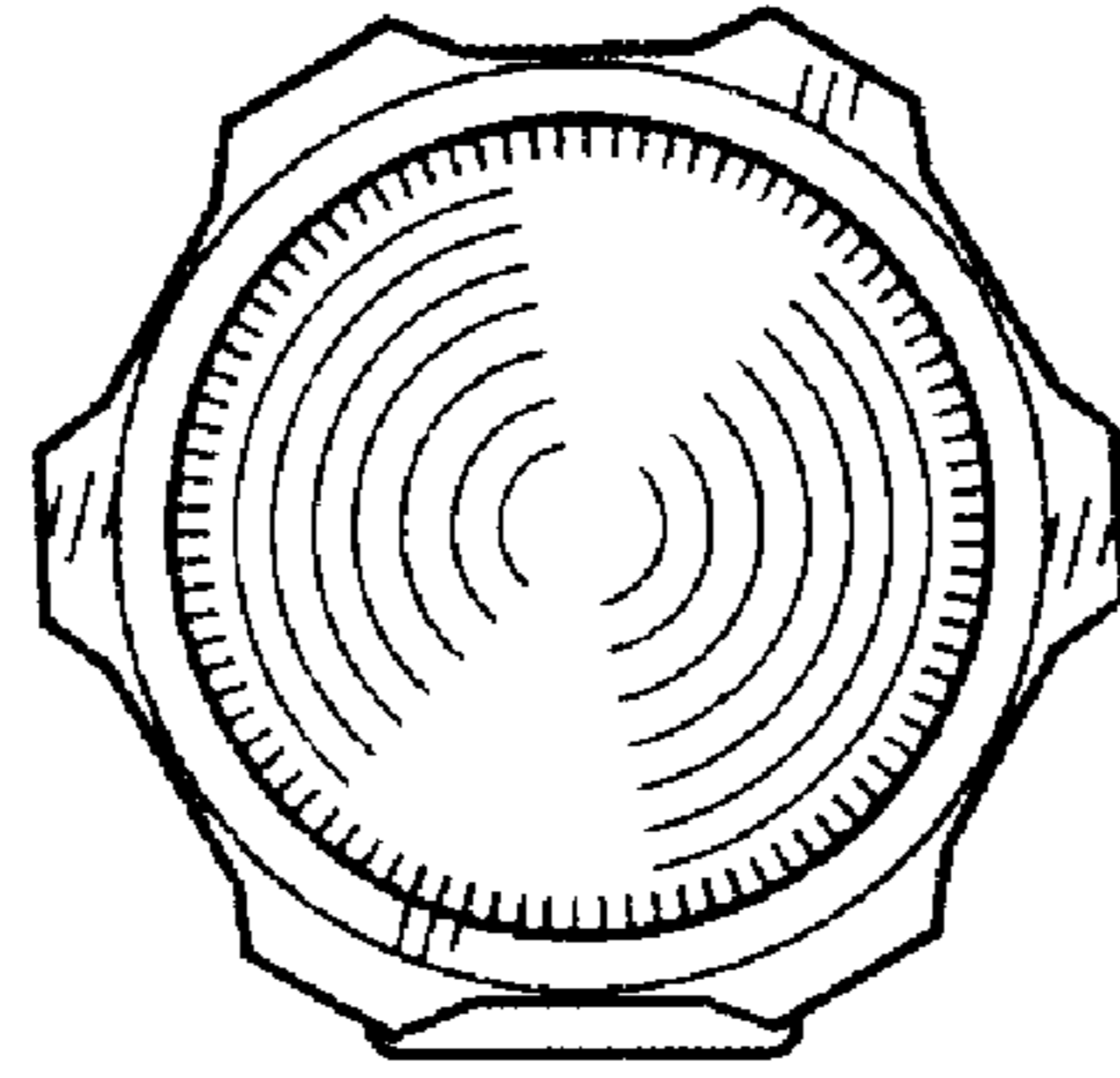

Figure 12

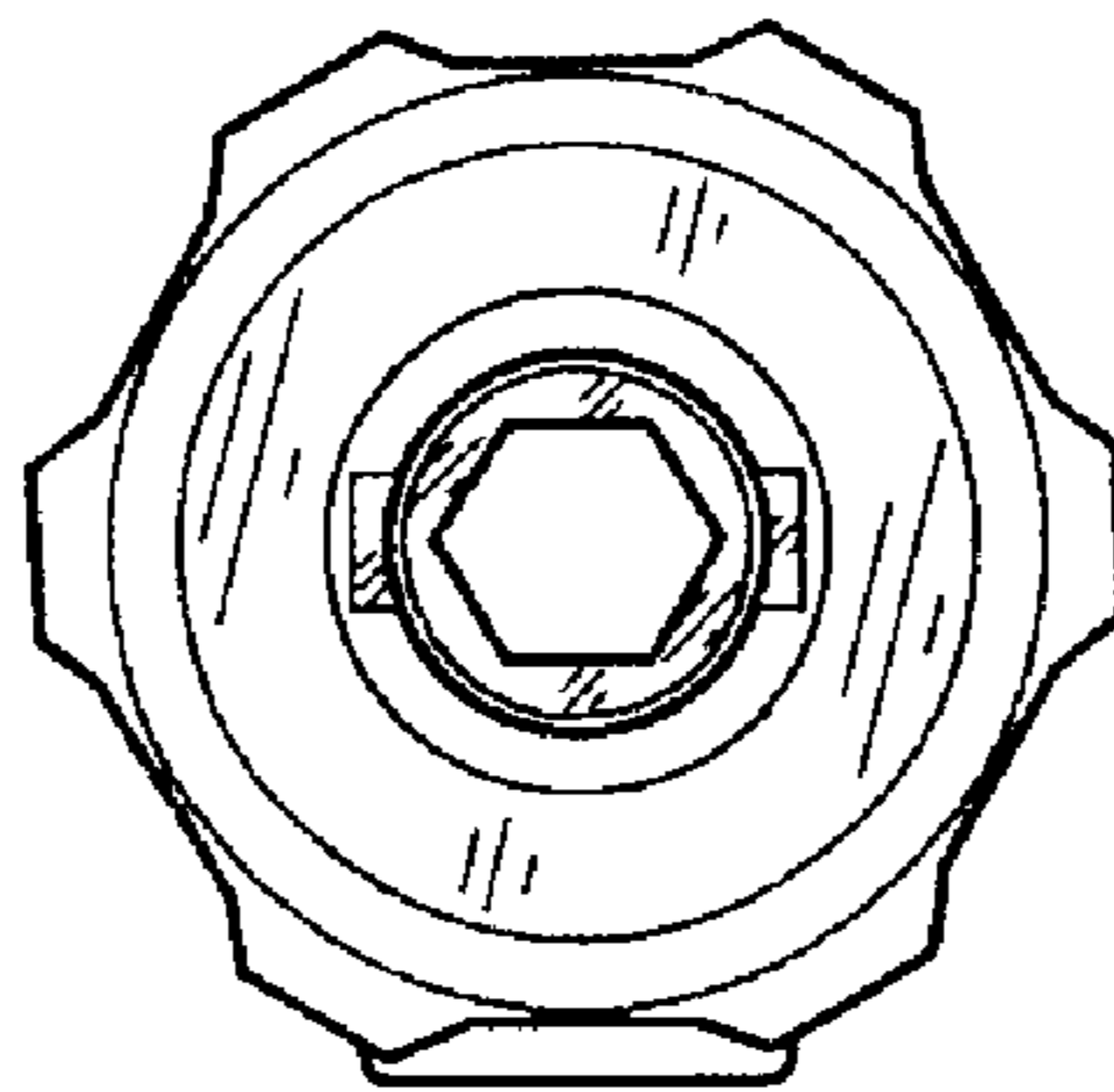

Figure 13