



US00D482583S

(12) **United States Design Patent**
Hawley et al.

(10) **Patent No.:** **US D482,583 S**

(45) **Date of Patent:** **** Nov. 25, 2003**

(54) **HAND-HELD OR MOUNTABLE JAR OR BOTTLE OPENER**

(76) Inventors: **Mark R. Hawley**, 504 S. Trenton, Tulsa, OK (US) 74120; **Gwen C. Booth**, 504 S. Trenton, Tulsa, OK (US) 74120

(**) Term: **14 Years**

(21) Appl. No.: **29/173,468**

(22) Filed: **Dec. 30, 2002**

(51) **LOC (7) Cl.** **07-99**

(52) **U.S. Cl.** **D8/33; D8/37; D8/40**

(58) **Field of Search** D8/17-19, 33-43; 7/151-156; 30/400-450; 81/3.07-3.49

(56) **References Cited**

U.S. PATENT DOCUMENTS

D164,459 S	9/1951	Stolpe	
D257,318 S	* 10/1980	Zorzi	D8/18
D258,192 S	2/1981	Maloney	D8/18
4,262,560 A	* 4/1981	Hoffberger	81/3.25
D267,624 S	1/1983	Funka, Sr.	D8/37
D277,925 S	3/1985	Blackburn	D8/37
5,154,101 A	10/1992	Wolford et al.	81/3.09
D382,783 S	8/1997	Martin	D8/37

D436,301 S 1/2001 Savio et al. D8/37

* cited by examiner

Primary Examiner—Caron D. Veynar

(57) **CLAIM**

The ornamental design for a hand-held or mountable jar or bottle opener, as shown and described.

DESCRIPTION

FIGS. 1, 2 and 3 are alternate perspective views of the hand-held or mountable jar or bottle opener with indented finger grips of the present invention;

FIG. 4 is a top view of the jar or bottle opener shown in FIGS. 1, 2 and 3;

FIG. 5 is a right side view of the jar or bottle opener shown in FIGS. 1, 2 and 3;

FIG. 6 is a left side view of the jar or bottle opener shown in FIGS. 1, 2 and 3;

FIG. 7 is a front view of the jar or bottle opener shown in FIGS. 1, 2 and 3;

FIG. 8 is a rear view of the jar or bottle opener shown in FIGS. 1, 2 and 3; and,

FIG. 9 is a bottom view of the jar or bottle opener shown in FIGS. 1, 2 and 3.

1 Claim, 2 Drawing Sheets

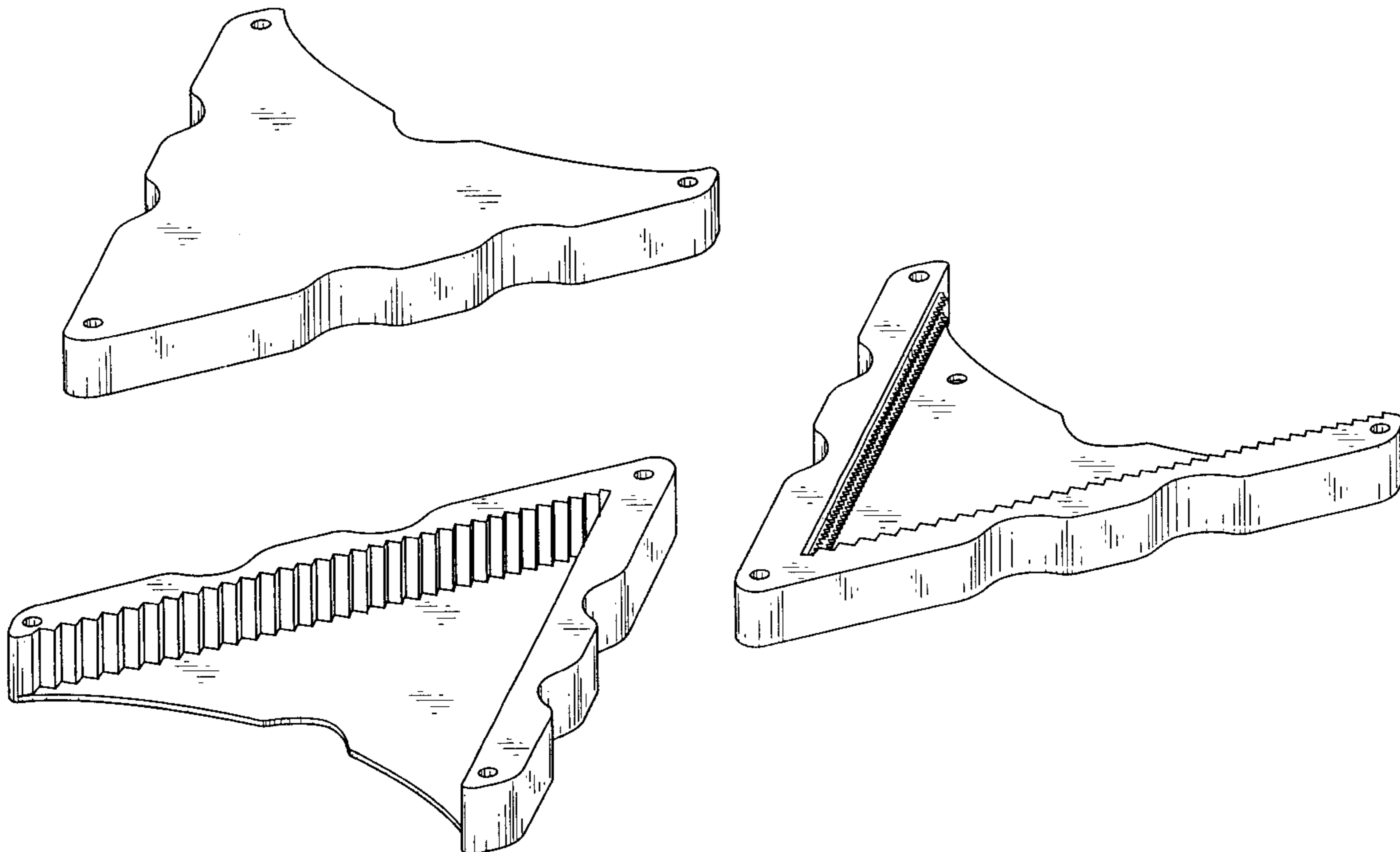

FIG. 1

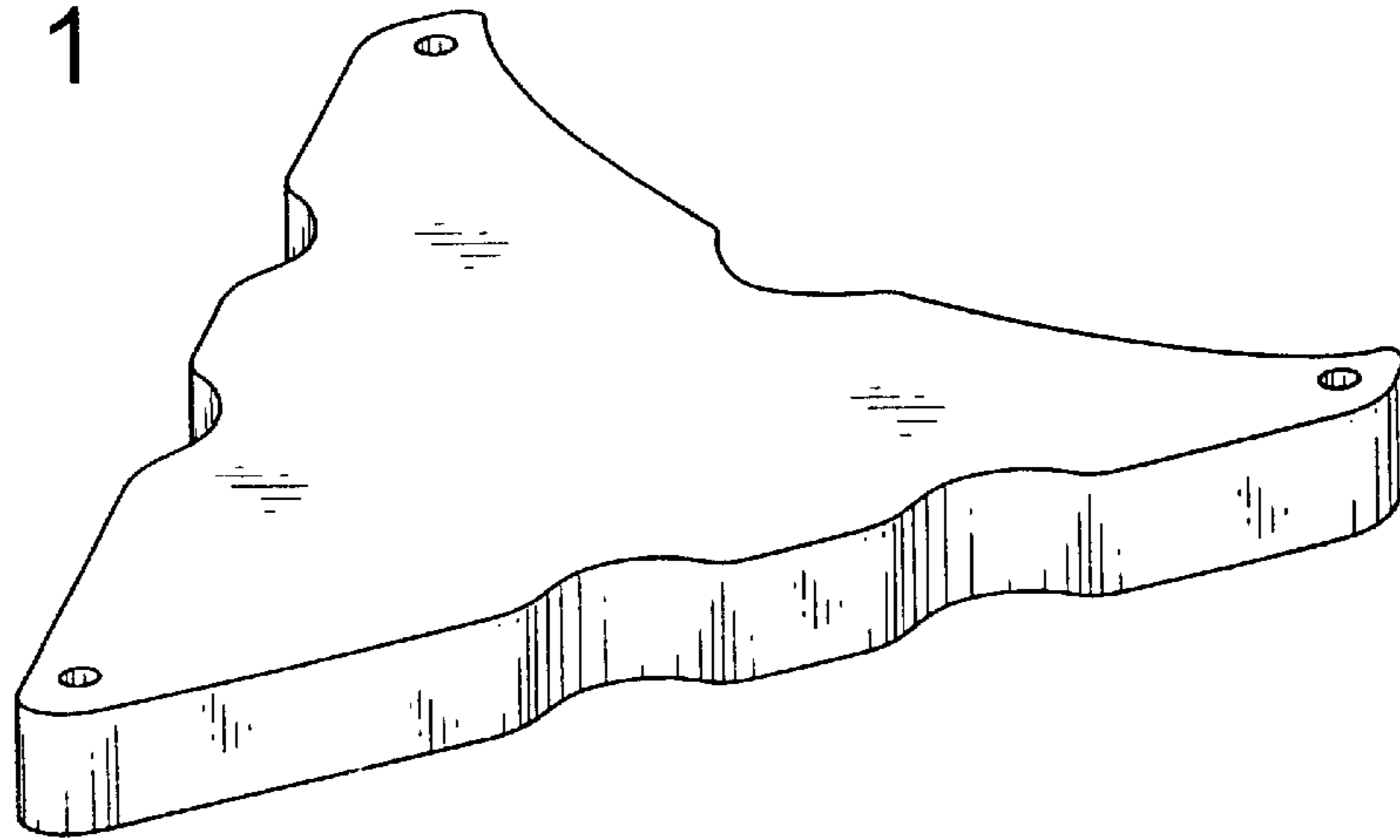

FIG. 2

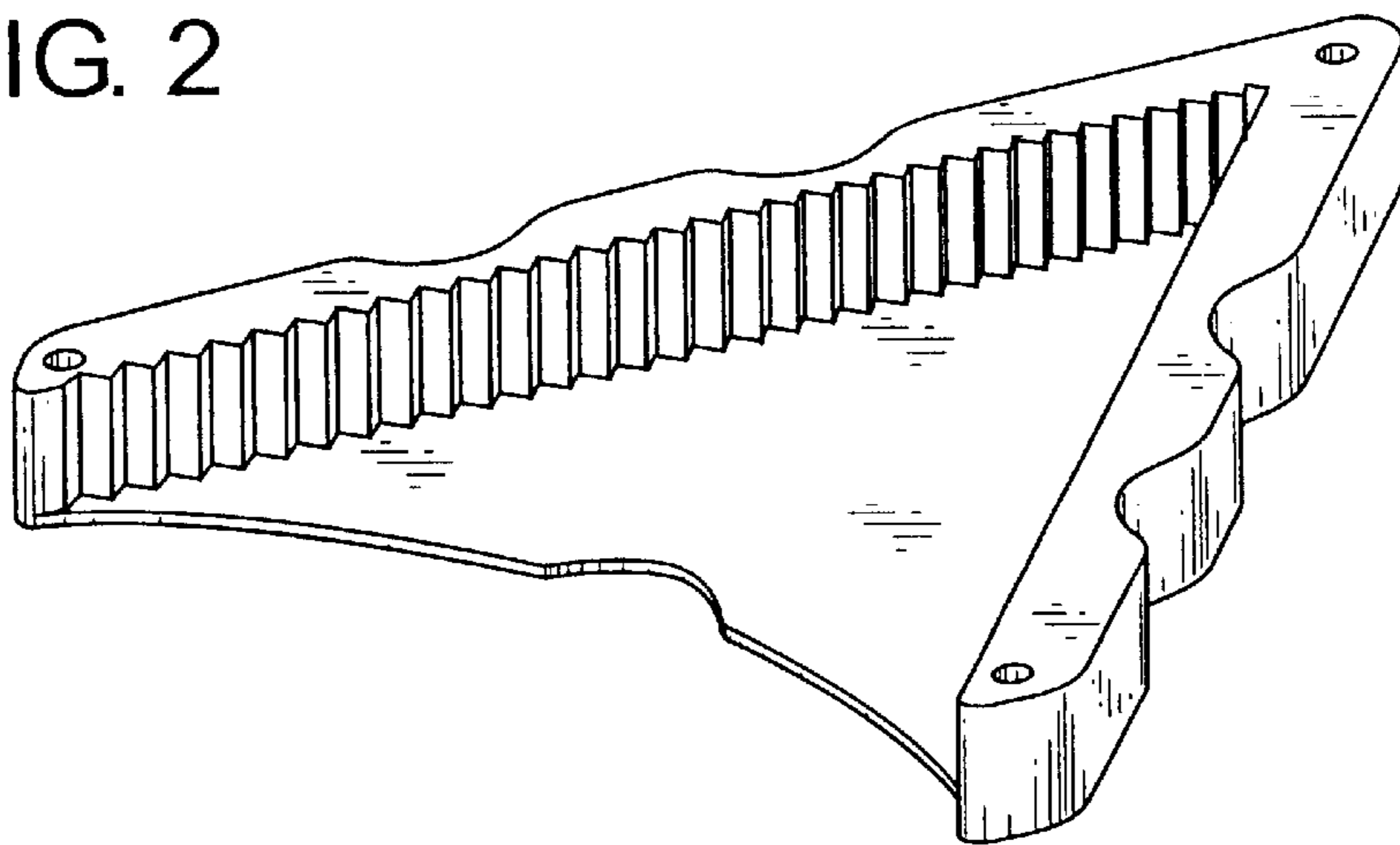

FIG. 3

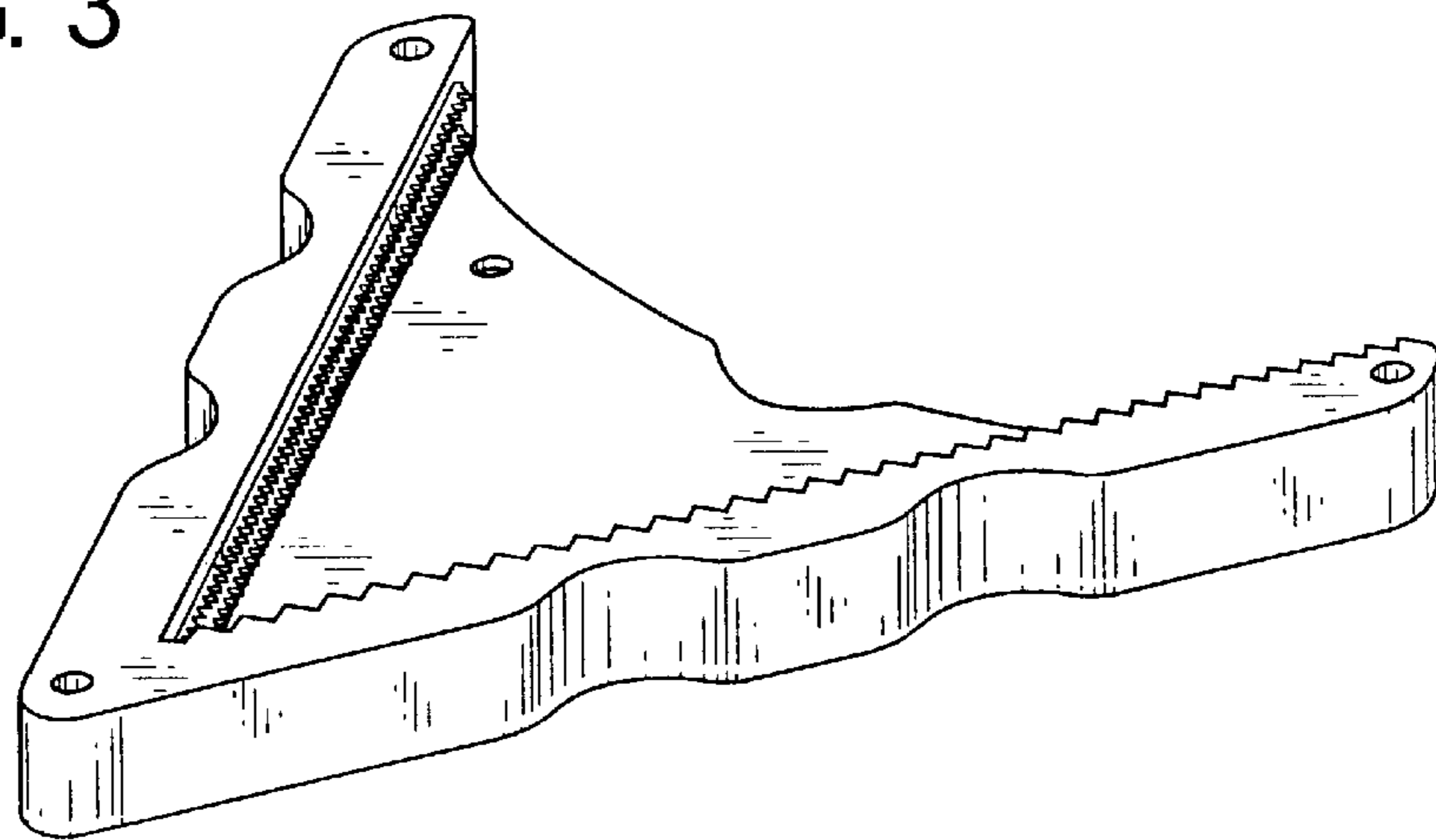

FIG. 4

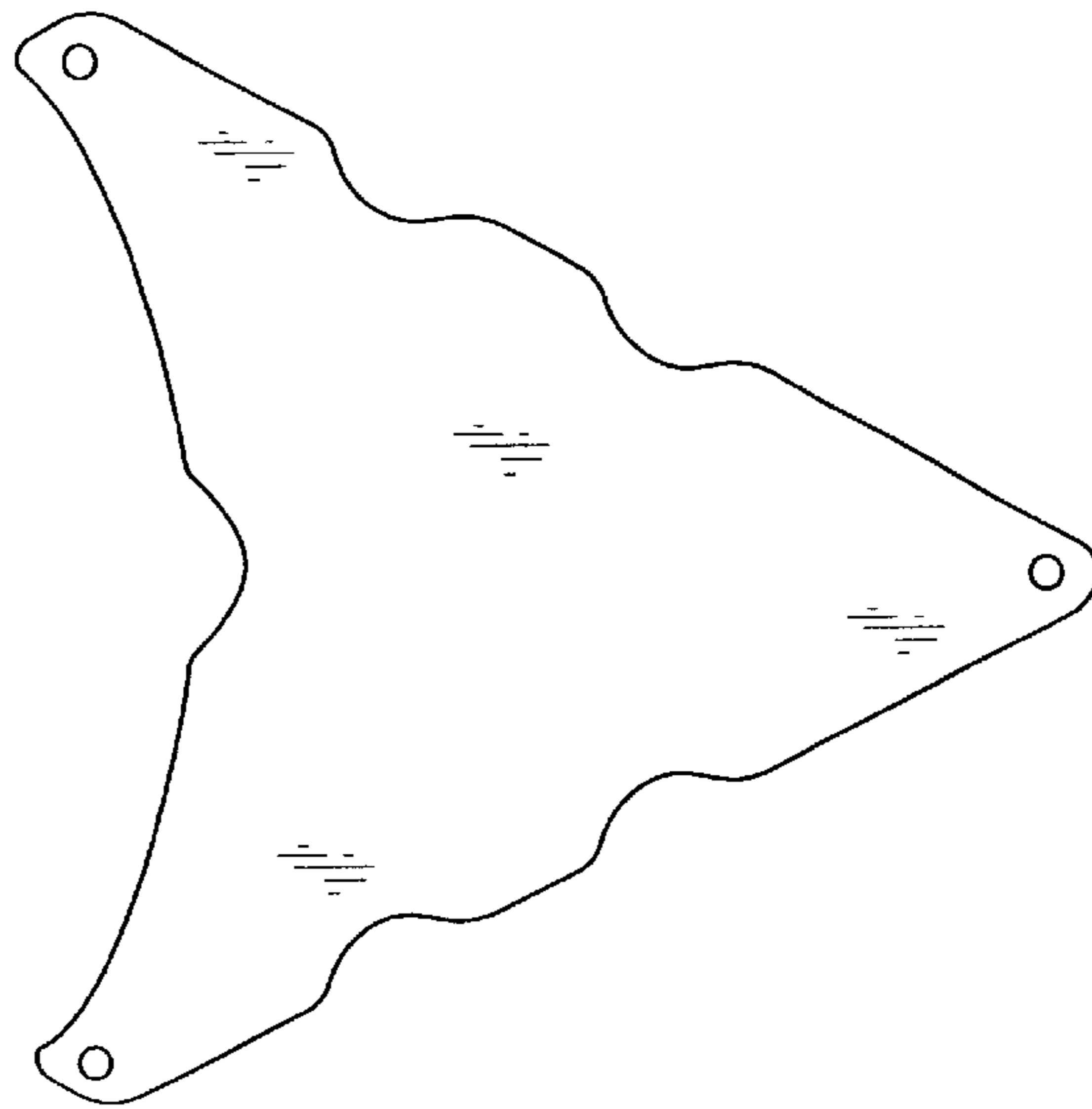

FIG. 5

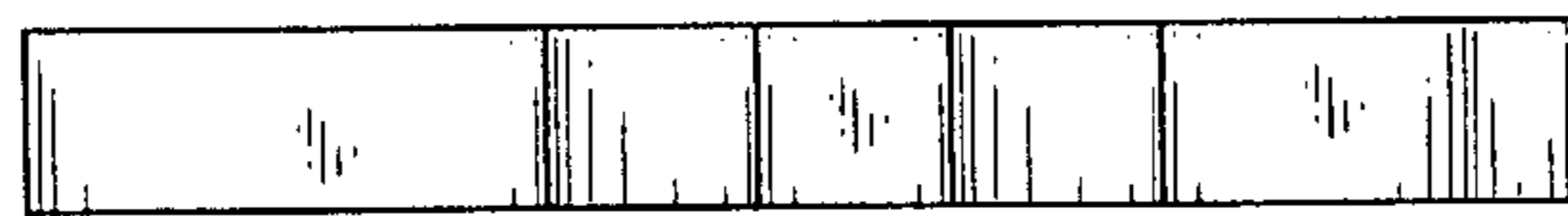

FIG. 6

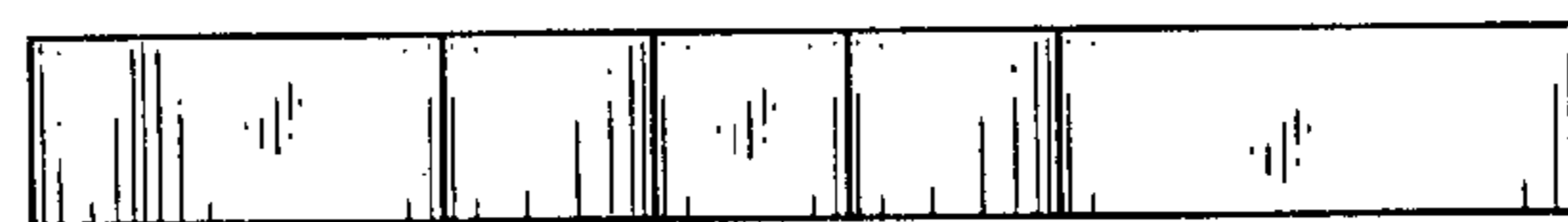

FIG. 7

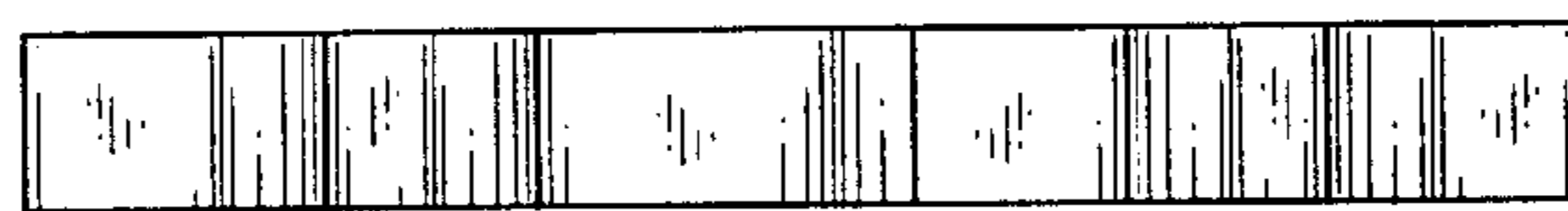

FIG. 8

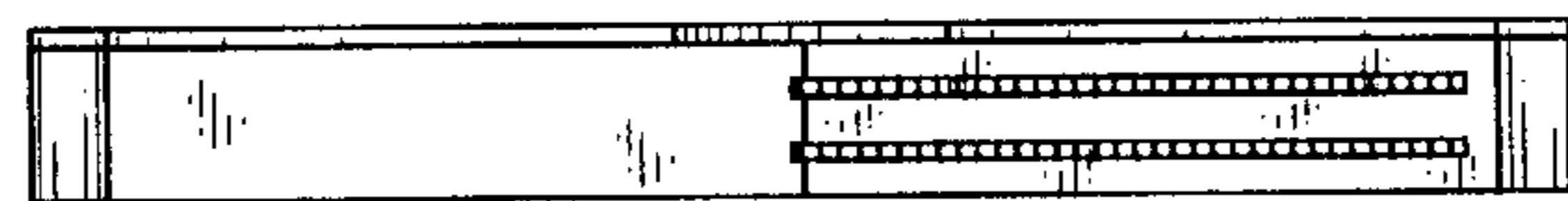

FIG. 9

