



US00D482443S

(12) **United States Design Patent**
Pasternak

(10) **Patent No.:** **US D482,443 S**

(45) **Date of Patent:** **** Nov. 18, 2003**

(54) **INHALATION DEVICE**

(75) Inventor: **Gary Pasternak**, Bantford, CA (US)

(73) Assignee: **SmithKline Beecham Corporation**,
Philadelphia, PA (US)

(**) Term: **14 Years**

(21) Appl. No.: **29/171,484**

(22) Filed: **Nov. 22, 2002**

(51) **LOC (7) Cl.** **29-02**

(52) **U.S. Cl.** **D24/110**

(58) **Field of Search** D24/110, 115;
128/200.23, 200.22, 203.23, 203.14, 200.14,
200.12, 203.12, 203.15; 222/153.11, 153.13,
153.14

(56) **References Cited**

U.S. PATENT DOCUMENTS

D295,787 S * 5/1988 Hegemann et al. D24/110
4,860,738 A * 8/1989 Hegemann et al. 128/200.22
D376,536 S * 12/1996 Maxwell et al. D24/115

* cited by examiner

Primary Examiner—Ian Simmons

(74) *Attorney, Agent, or Firm*—James P. Riek

(57) **CLAIM**

The ornamental design for an inhalation device, as shown and described.

DESCRIPTION

FIG. 1 is a perspective view of the inhalation device of our new design (with an actuator cover cap);

FIG. 2 is a side view of of the inhalation device depicted in FIG. 1.

FIG. 3 is a side view of the opposite side of the inhalation device depicted in FIG. 2.

FIG. 4 is a rear view of the inhalation device depicted in FIG. 1;

FIG. 5 is a front view of the inhalation device depicted in FIG. 1;

FIG. 6 is a top view of the inhalation device depicted in FIG. 1;

FIG. 7 is a bottom view of the inhalation device depicted in FIG. 1;

FIG. 8 is a perspective view of the inhalation device of our new design (with a cover cap shown in relief);

FIG. 9 is a side view of the inhalation device depicted in FIG. 8 (without a cover cap).

FIG. 10 is a side view of the opposite side of FIG. 9

FIG. 11 is a rear view of the inhalation device as depicted in FIG. 8.

FIG. 12 is a front view of the inhalation device as depicted in FIG. 8.

FIG. 13 is a top view of the inhalation device as depicted in FIG. 8; and,

FIG. 14 is a bottom view of the inhalation device as depicted in FIG. 8.

1 Claim, 6 Drawing Sheets

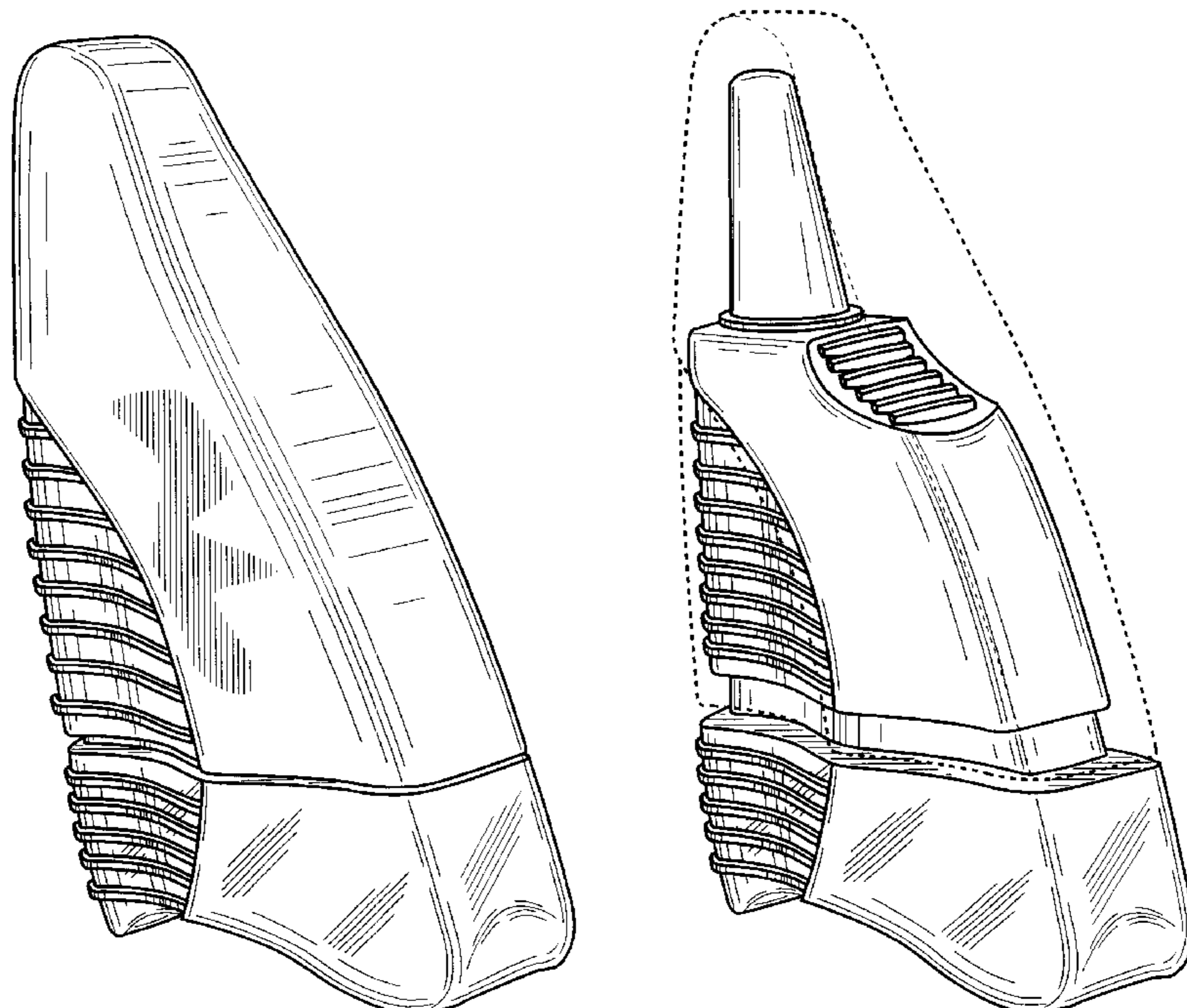

FIG. 1

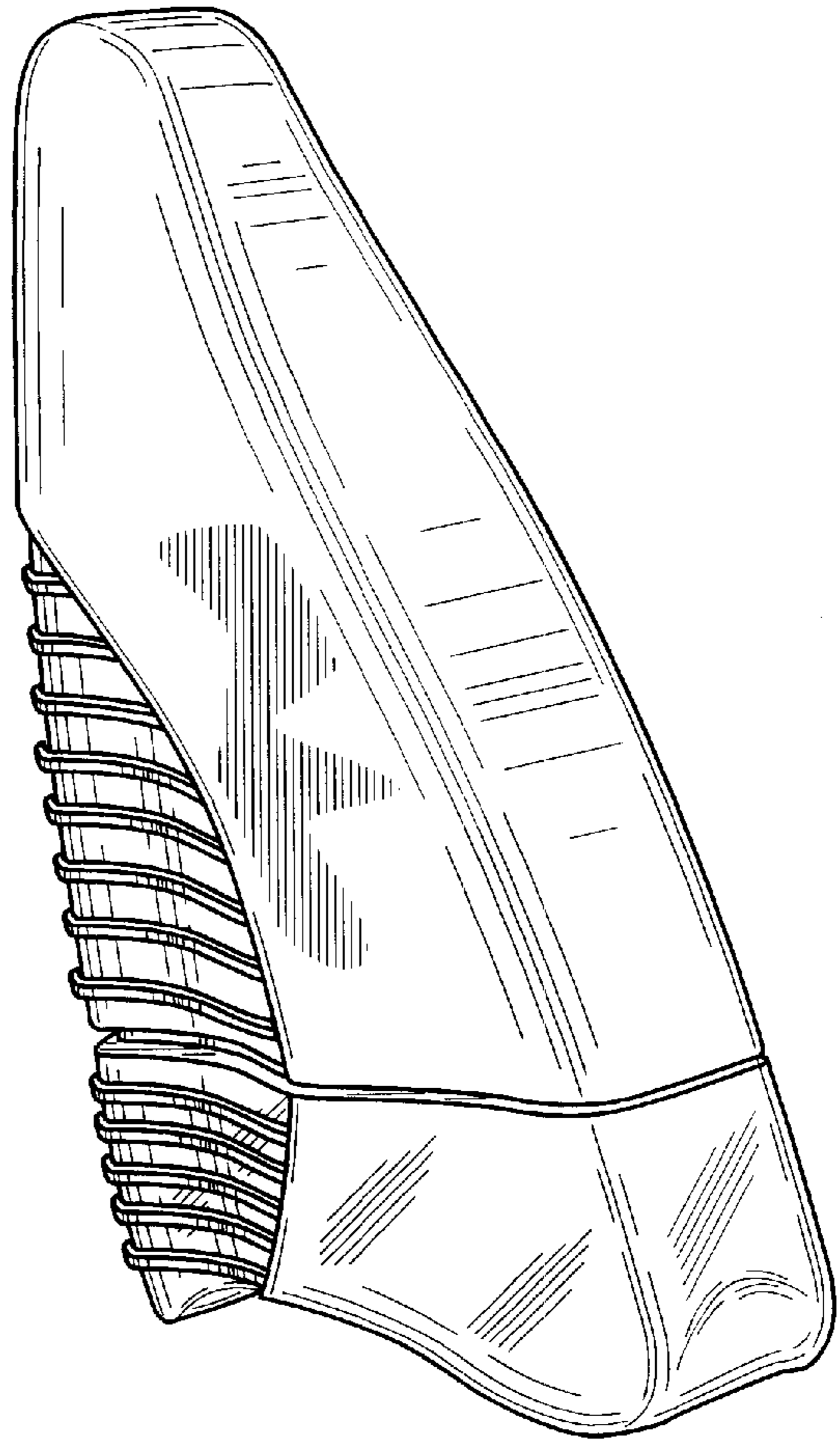
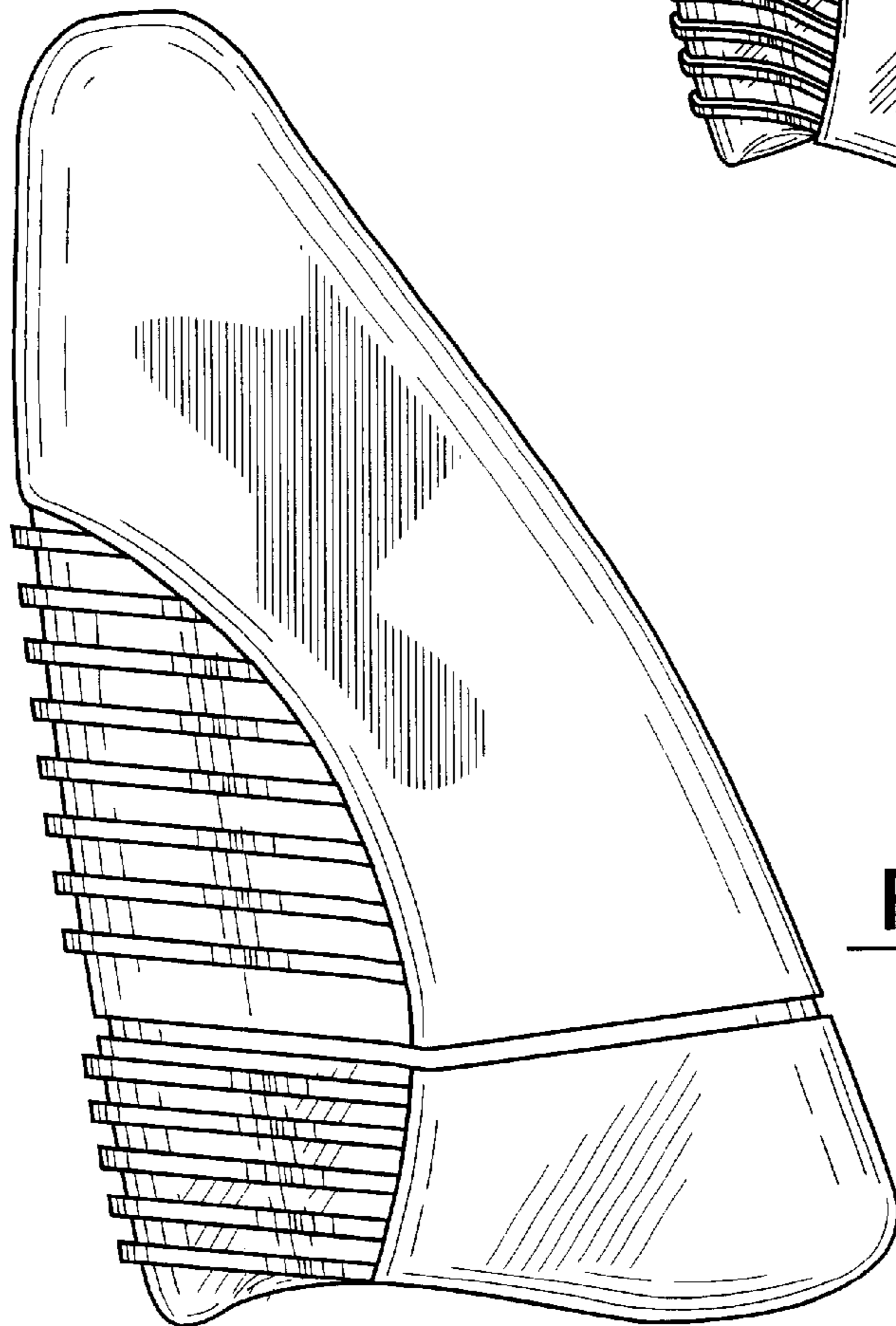
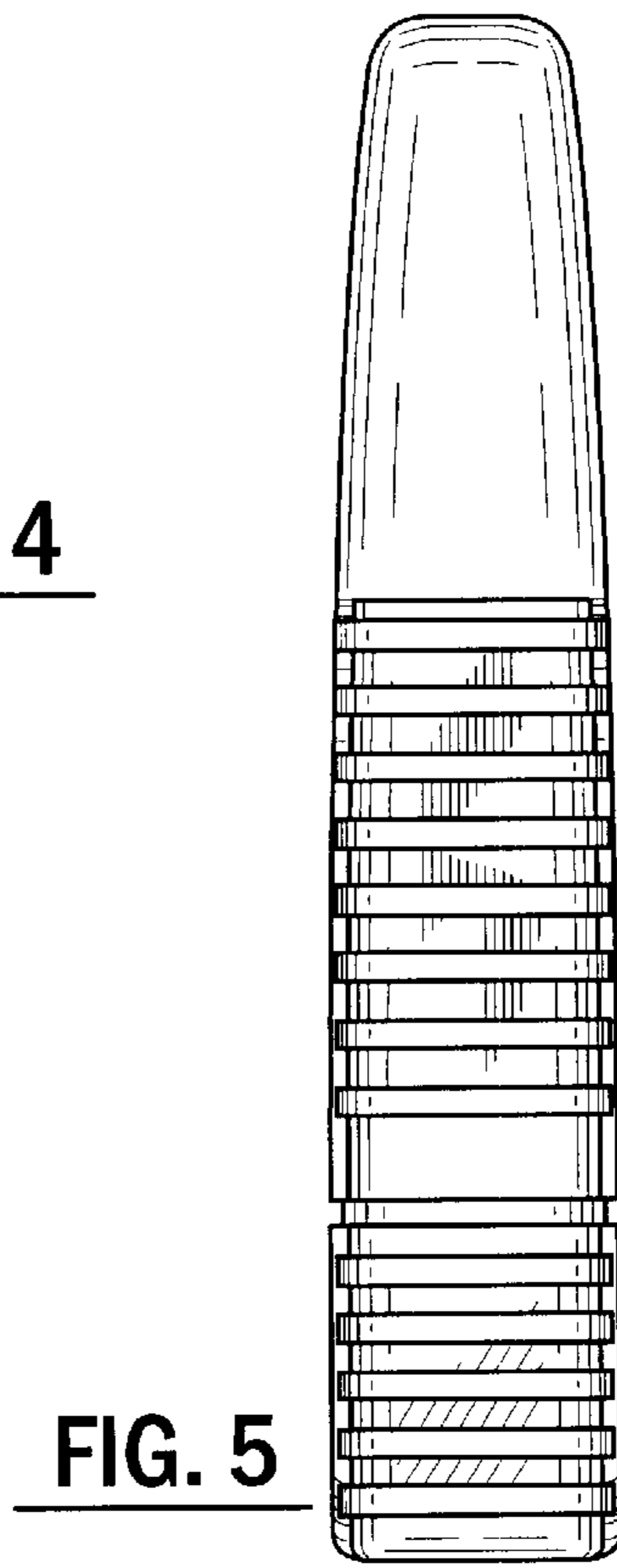
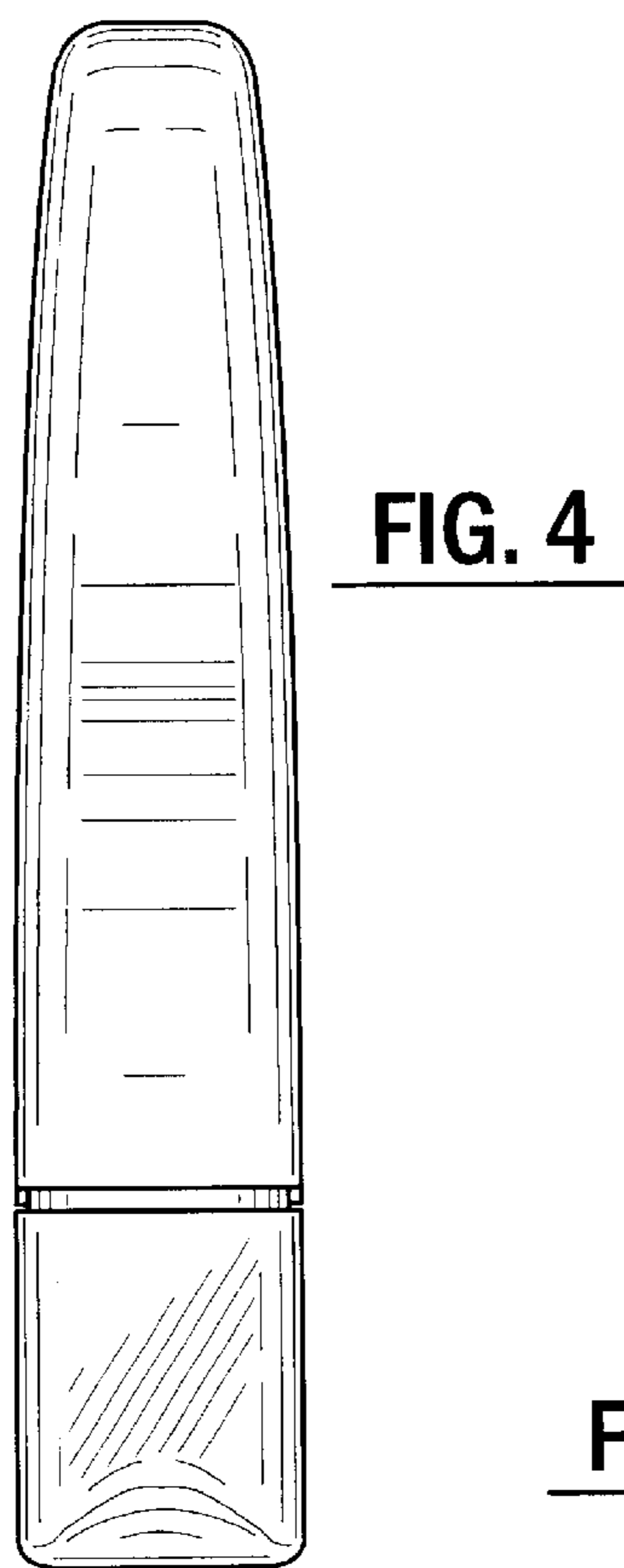
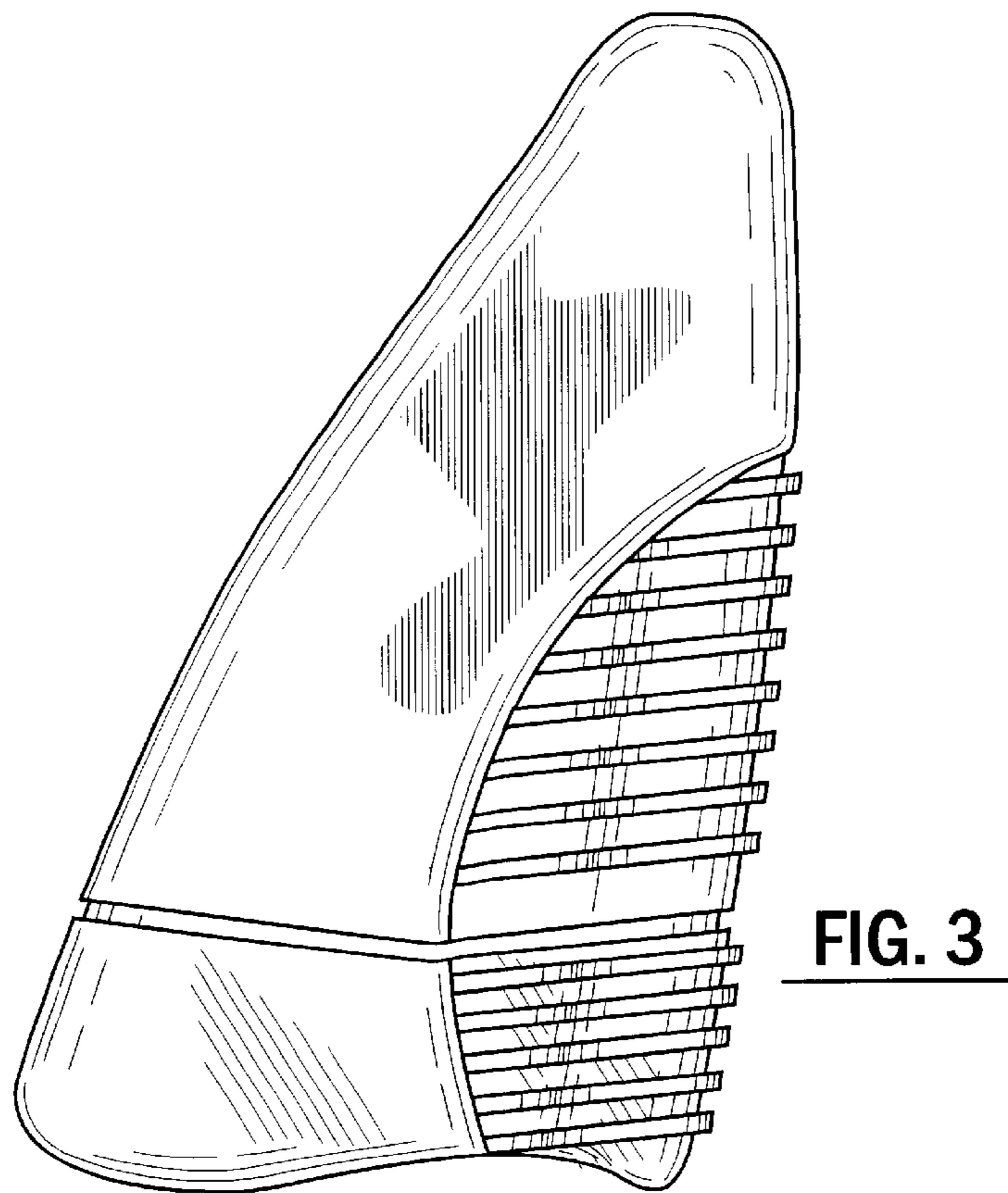

FIG. 2





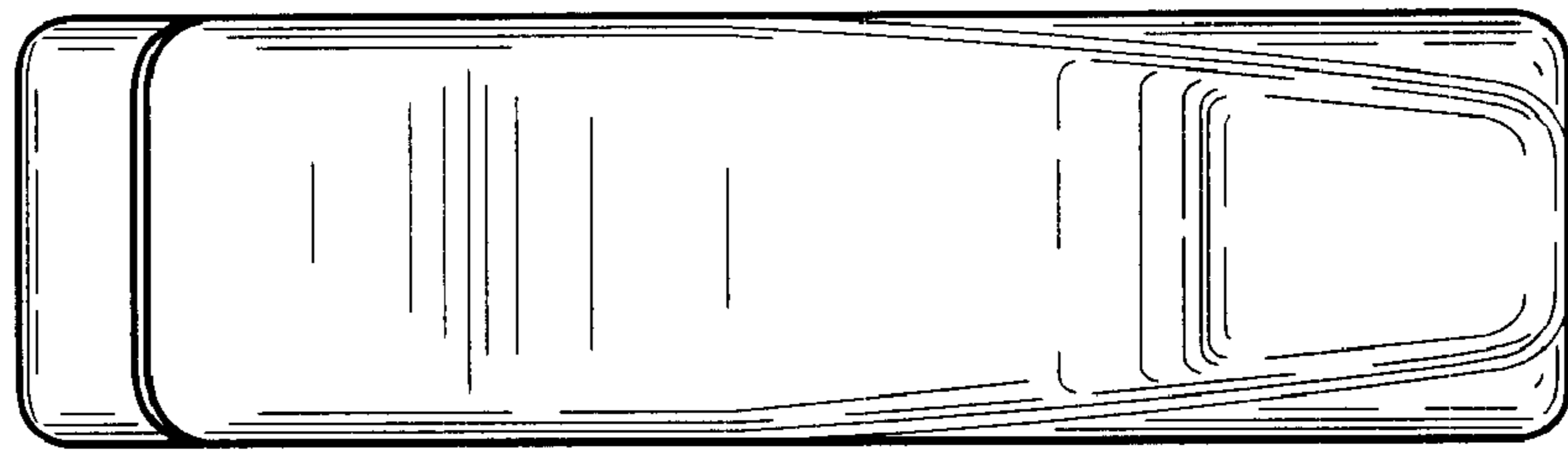

FIG. 6

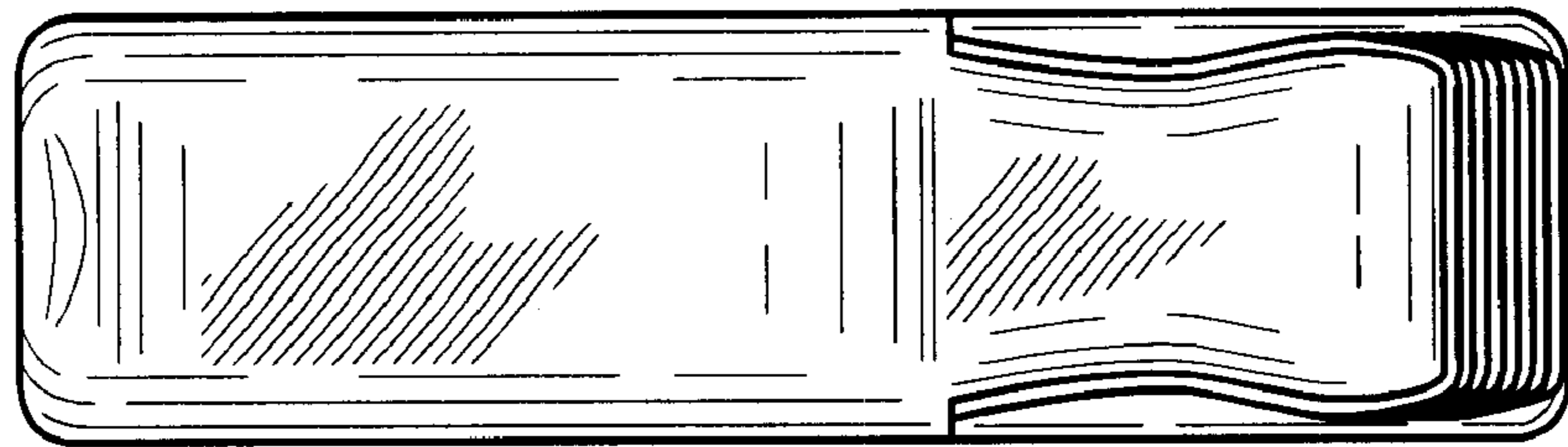

FIG. 7

FIG. 8

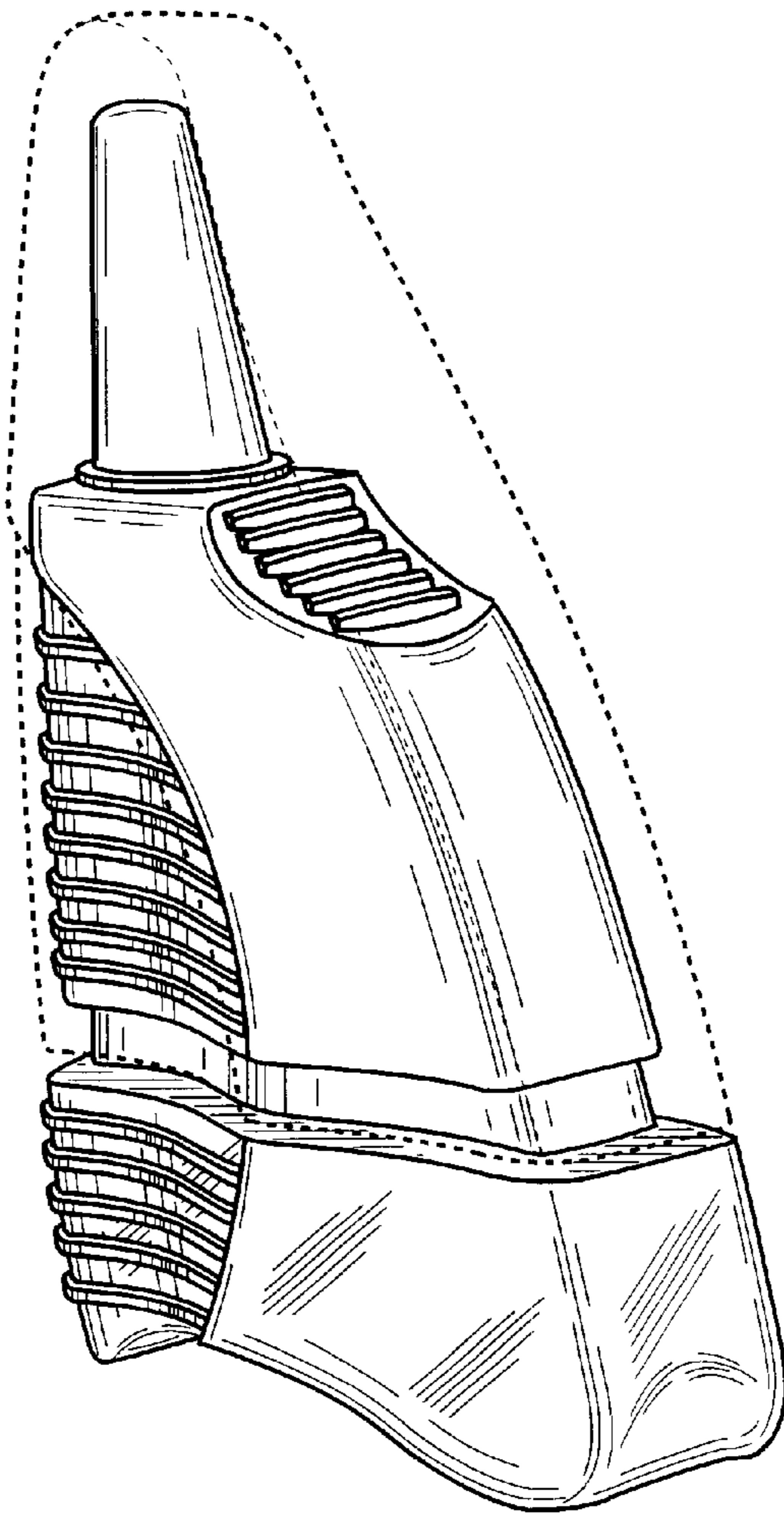
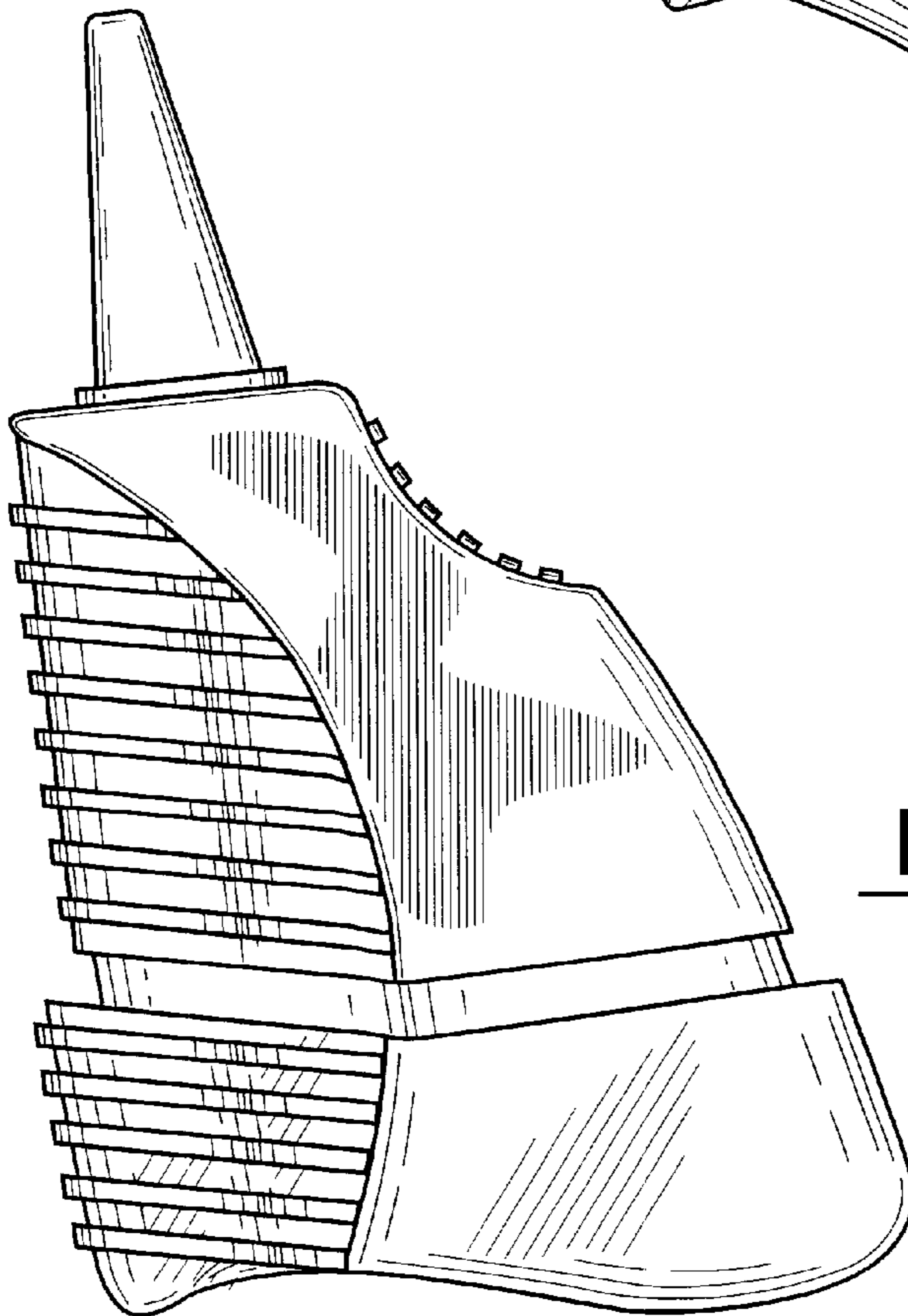

FIG. 9



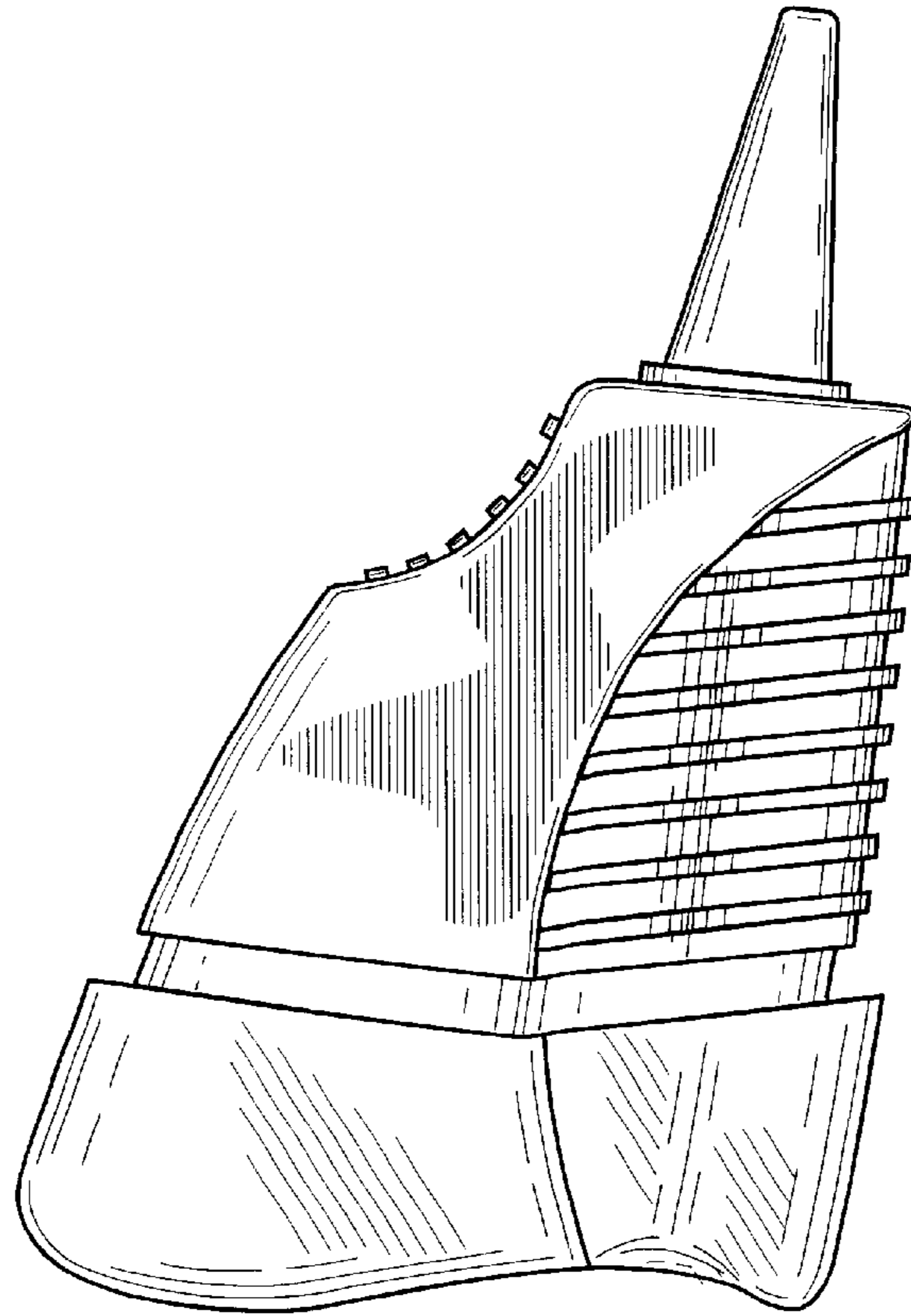

FIG. 10

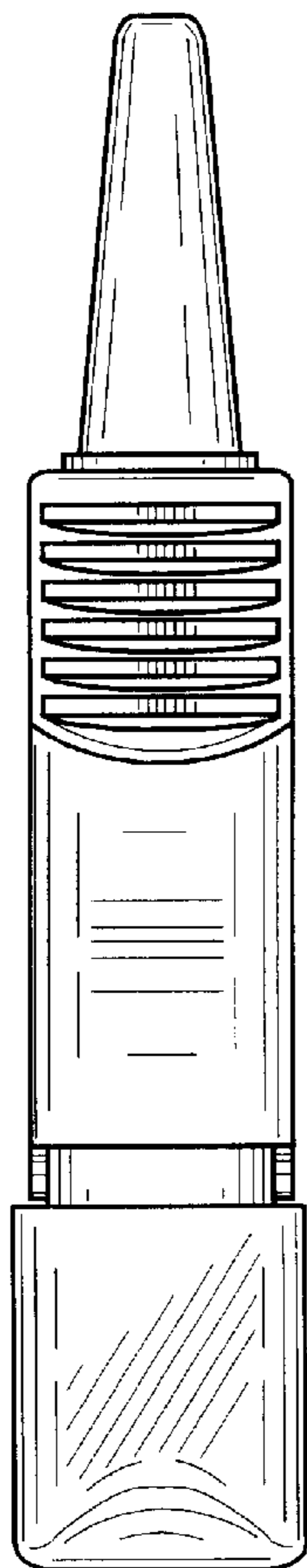

FIG. 11

FIG. 12



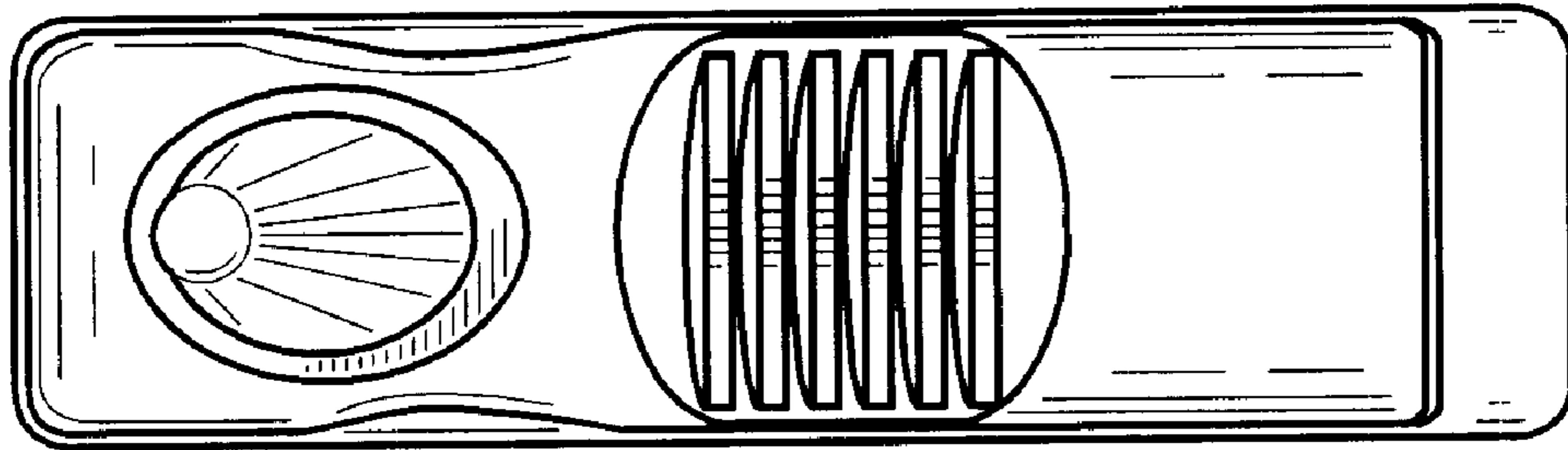

FIG. 13

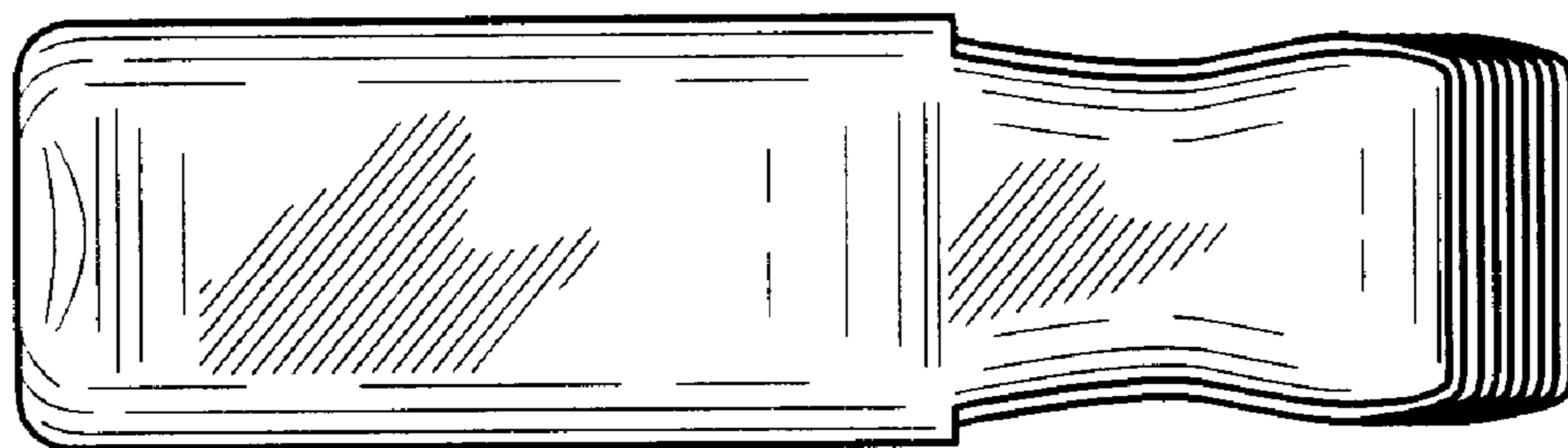

FIG. 14

UNITED STATES PATENT AND TRADEMARK OFFICE
CERTIFICATE OF CORRECTION

PATENT NO. : Des. 482,443 S
DATED : November 18, 2003
INVENTOR(S) : Gary Pasternak

Page 1 of 1

It is certified that error appears in the above-identified patent and that said Letters Patent is hereby corrected as shown below:

Title page.

Item [73] Assignee, insert -- **Glaxo Group Limited**, Greenford, Middlesex (UK) --.

Signed and Sealed this

First Day of November, 2005

A handwritten signature in black ink on a light gray dotted background. The signature reads "Jon W. Dudas" in a cursive style.

JON W. DUDAS

Director of the United States Patent and Trademark Office