



US00D482417S

(12) **United States Design Patent** (10) **Patent No.:** **US D482,417 S**
Oister et al. (45) **Date of Patent:** **** Nov. 18, 2003**

(54) **BASKETBALL GAME**

OTHER PUBLICATIONS

(75) Inventors: **Michael J. Oister**, Superior, CO (US);
Christopher S. Wisener, Westminster,
CO (US); **William C. Boettcher**,
Denver, CO (US); **Thomas M.**
Doherty, Denver, CO (US)

Picture of a Franklin Sports, Inc. tabletop basketball game.
(A table top basketball game with a basketball, a flat playing
surface, back panel with basketball hoop, enclosed with side
and back panels of mesh.)

* cited by examiner

(73) Assignee: **Classic Sport Companies, Inc.**,
Westminster, CO (US)

Primary Examiner—Prabhakar Deshmukh
(74) *Attorney, Agent, or Firm*—Holland & Hart

(**) Term: **14 Years**

(57) **CLAIM**

(21) Appl. No.: **29/173,521**

The ornamental design for a basketball game, as shown and
described.

(22) Filed: **Dec. 31, 2002**

DESCRIPTION

(51) **LOC (7) Cl.** **21-02**

(52) **U.S. Cl.** **D21/702; D21/313**

(58) **Field of Search** D21/300, 312,
D21/313, 314, 318, 701-705; 273/317,
317.1, 317.3, 348; 473/479-489, 447

FIG. 1 is a perspective view of a basketball game having a
playing surface showing our new design;
FIG. 2 is a right side elevation view thereof,
FIG. 3 is a left side elevation view thereof,
FIG. 4 is a back side elevation view thereof,
FIG. 5 is a front side elevation view thereof;
FIG. 6 is top plan view thereof,
FIG. 7 is a bottom plan view thereof,
FIG. 8 is a perspective view of a basketball game without a
playing surface showing our new design,
FIG. 9 is a right side elevation view thereof,
FIG. 10 is a left side elevation view thereof,
FIG. 11 is a back side elevation view thereof,
FIG. 12 is a front side elevation view thereof,
FIG. 13 is a top plan view thereof; and,
FIG. 14 is a bottom plan view thereof.

(56) **References Cited**

U.S. PATENT DOCUMENTS

2,247,852	A	*	7/1941	Saunders	273/348
3,724,855	A	*	4/1973	Chu	273/317.3
3,834,701	A	*	9/1974	Hashimoto	273/317.3
D235,897	S	*	7/1975	Breneman	D21/702
4,629,188	A	*	12/1986	Mahieu	273/407
D307,616	S	*	5/1990	Kelly	D21/702
D321,846	S	*	11/1991	Nys	D21/702
D338,249	S	*	8/1993	Buhrow	D21/702
5,288,071	A	*	2/1994	Solomon	273/317.3
5,788,242	A	*	8/1998	Rudell et al.	273/317.3
5,967,513	A	*	10/1999	Wells	273/317.3
6,554,724	B2	*	4/2003	Taylor	273/317.3

1 Claim, 8 Drawing Sheets

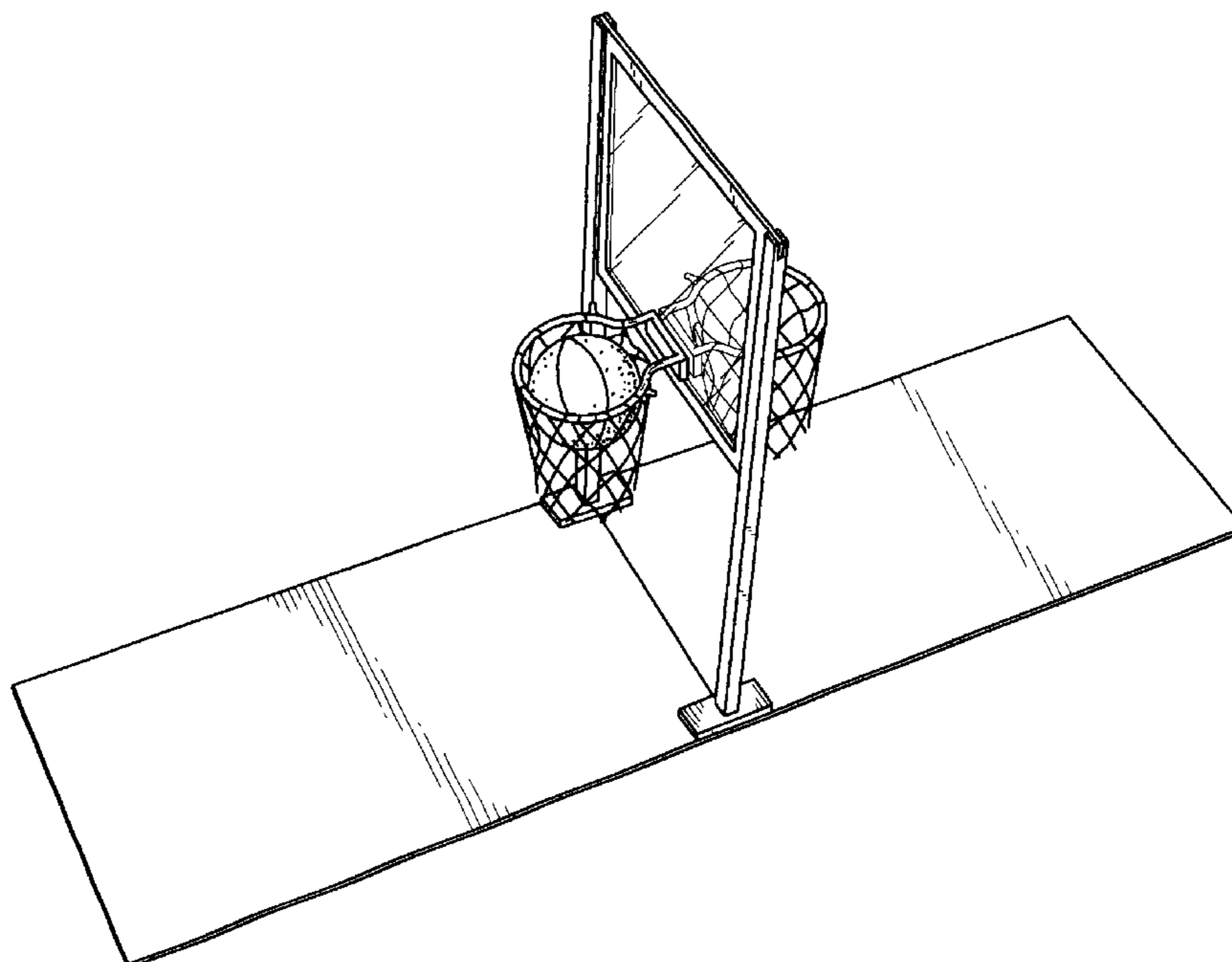

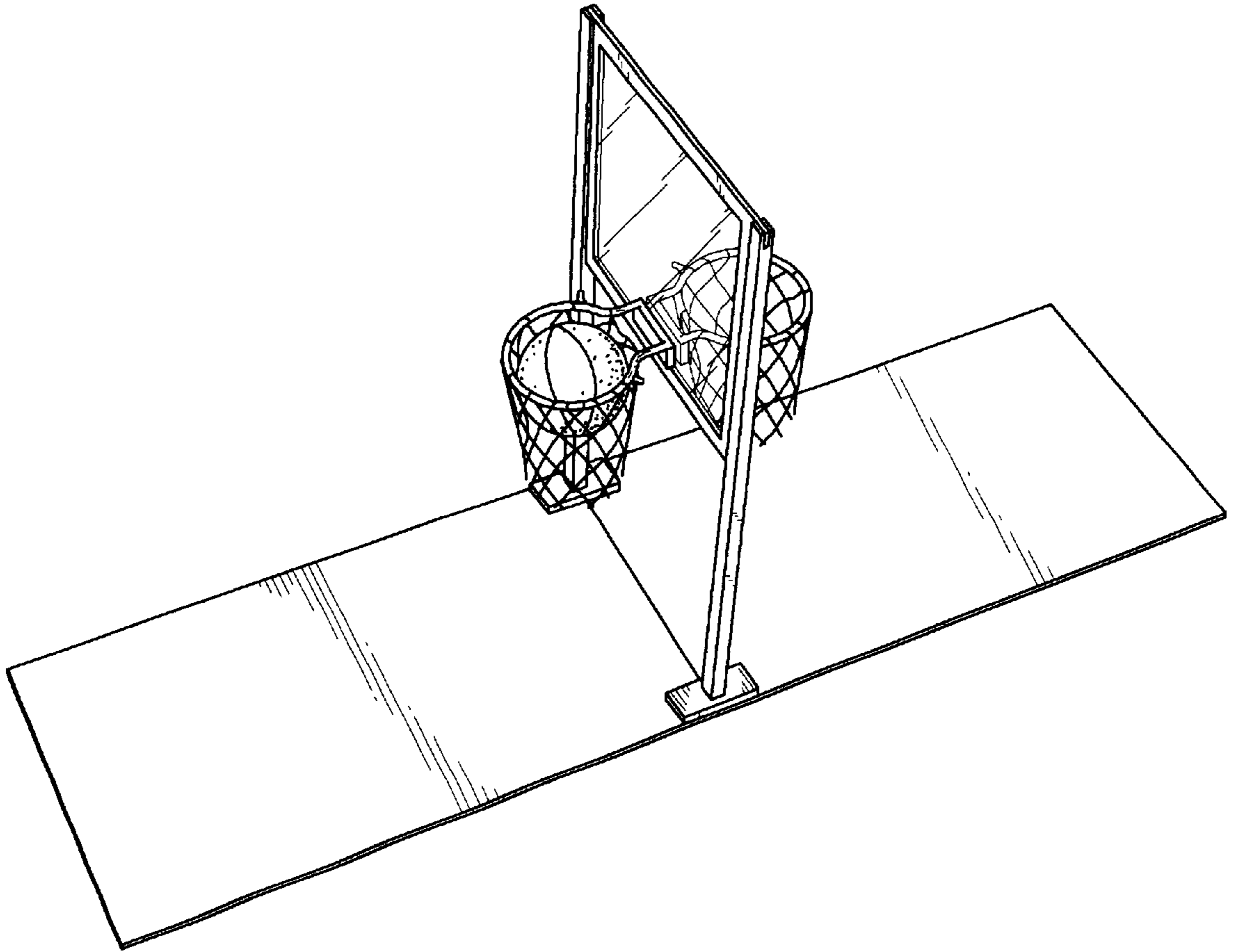

FIG.1

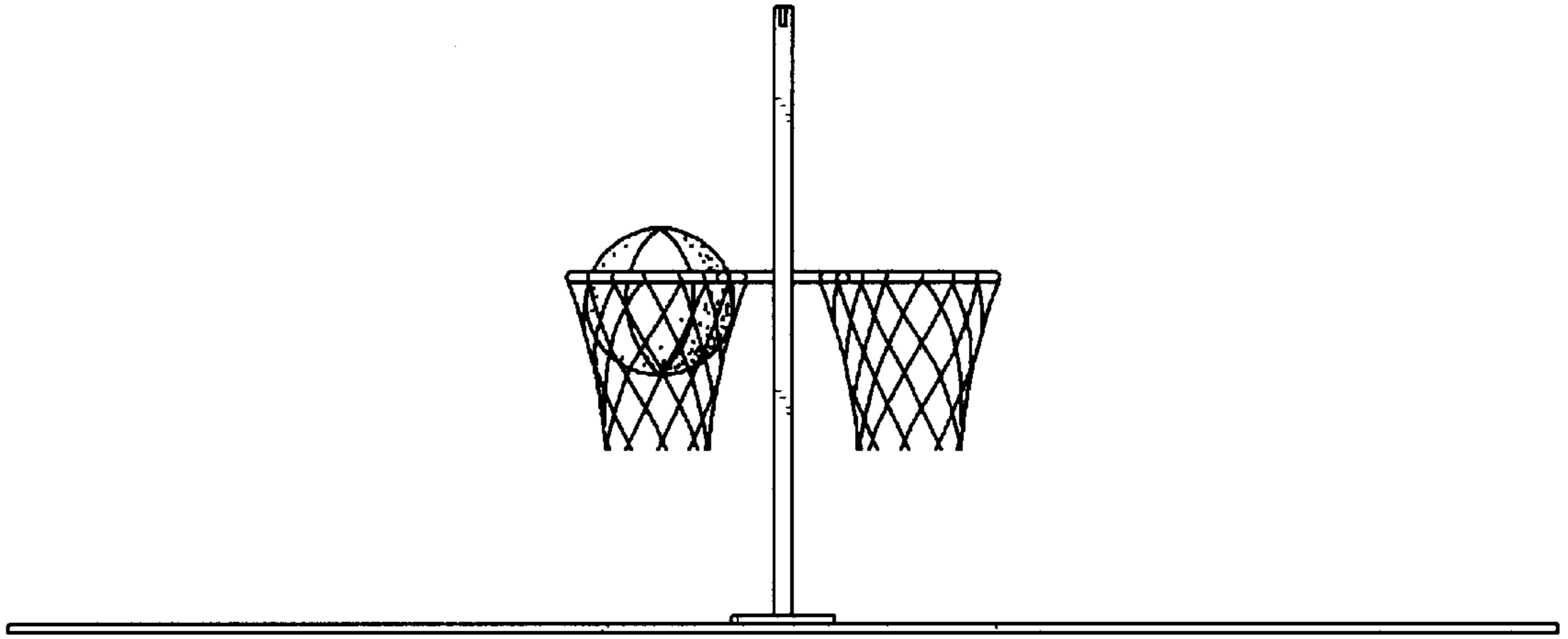

FIG. 2

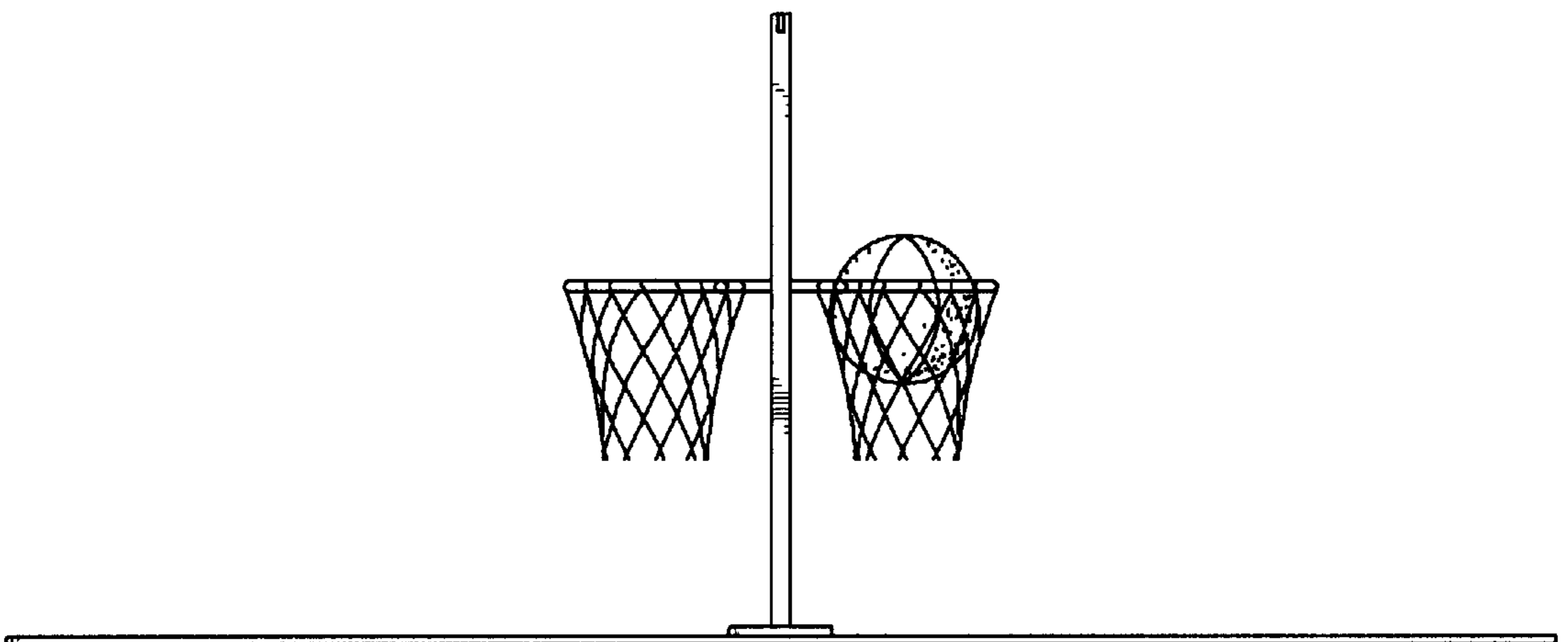

FIG. 3

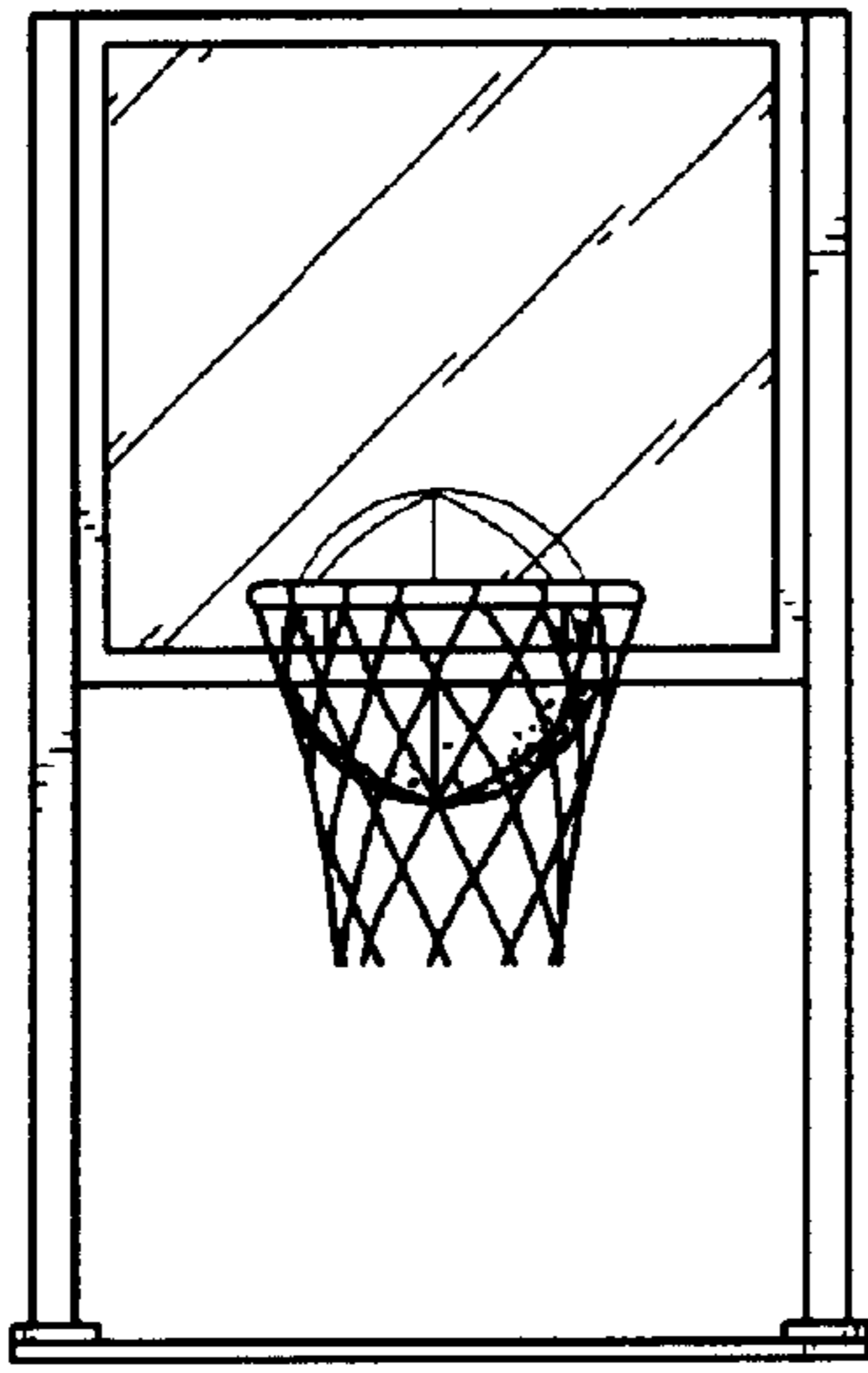

FIG. 4

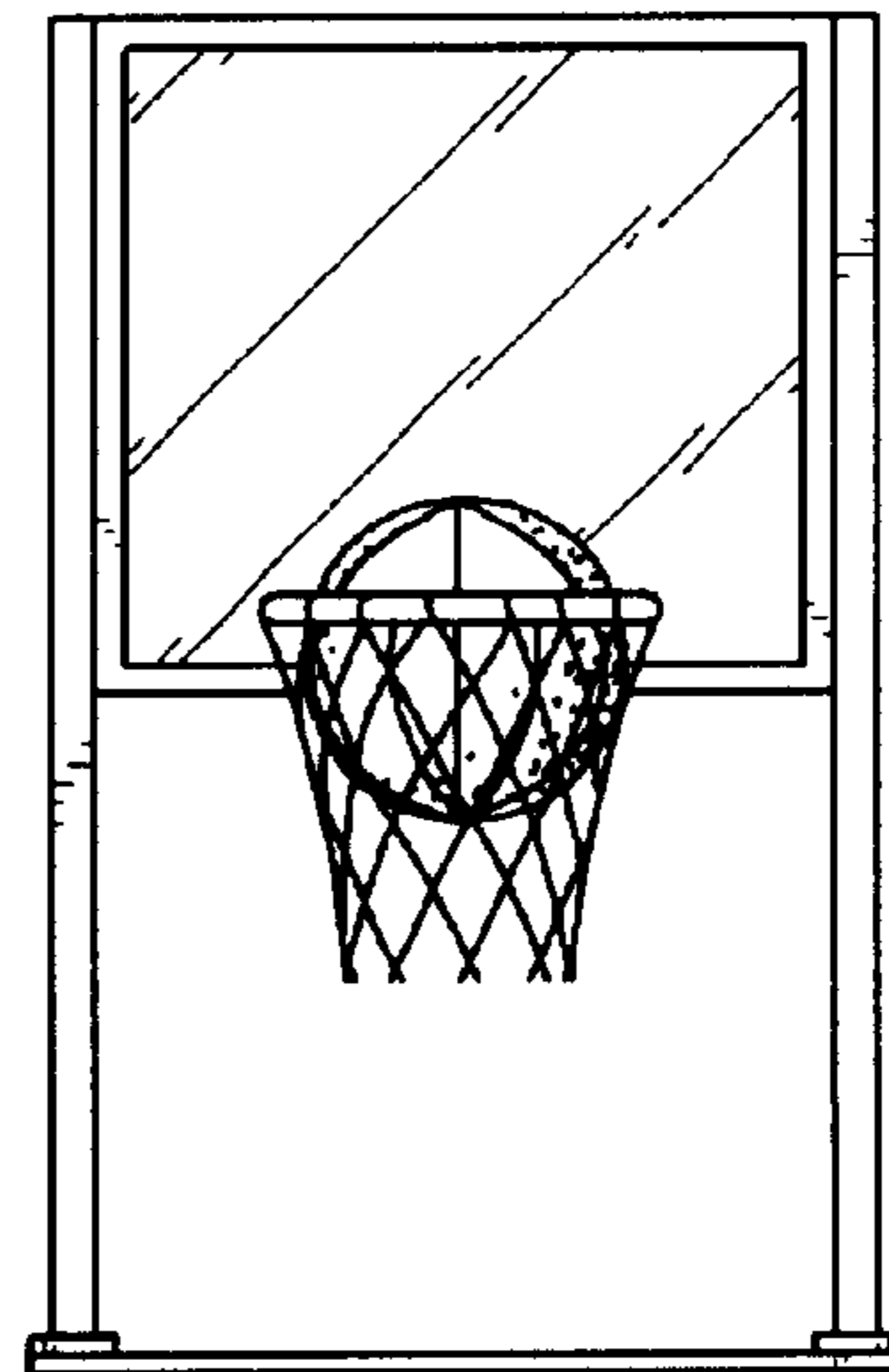

FIG. 5

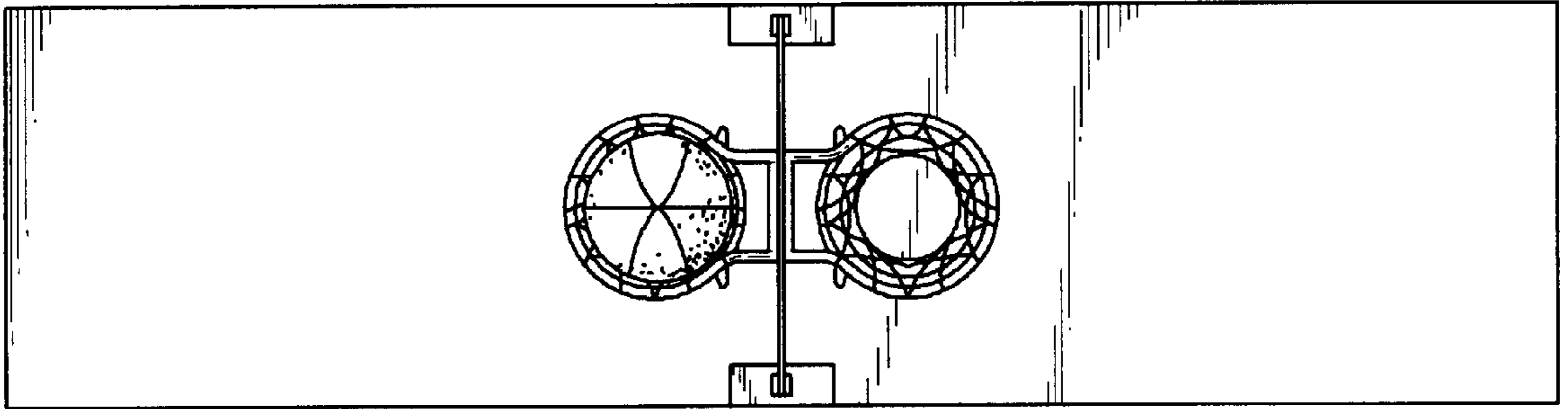

FIG. 6

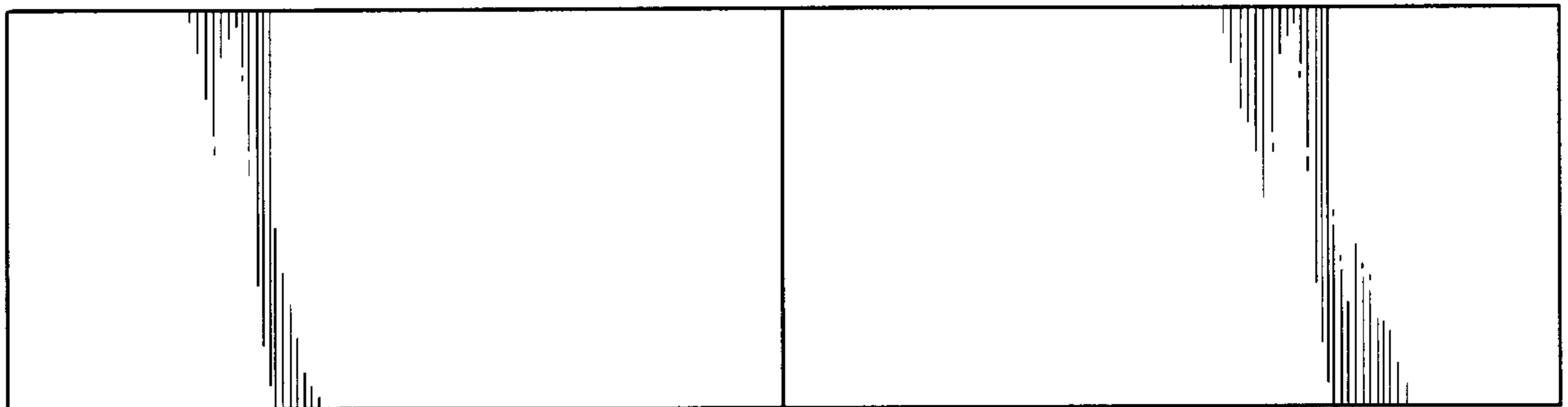

FIG. 7

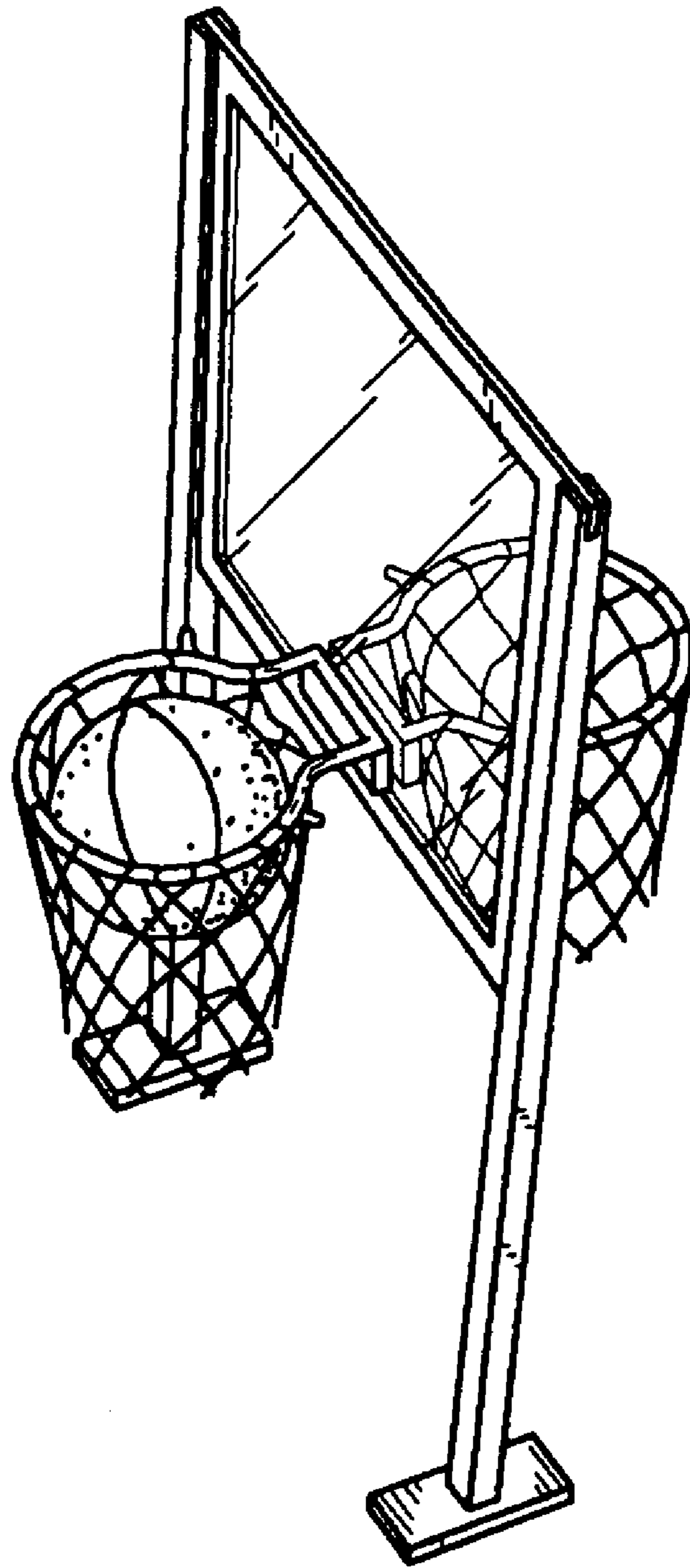

FIG. 8

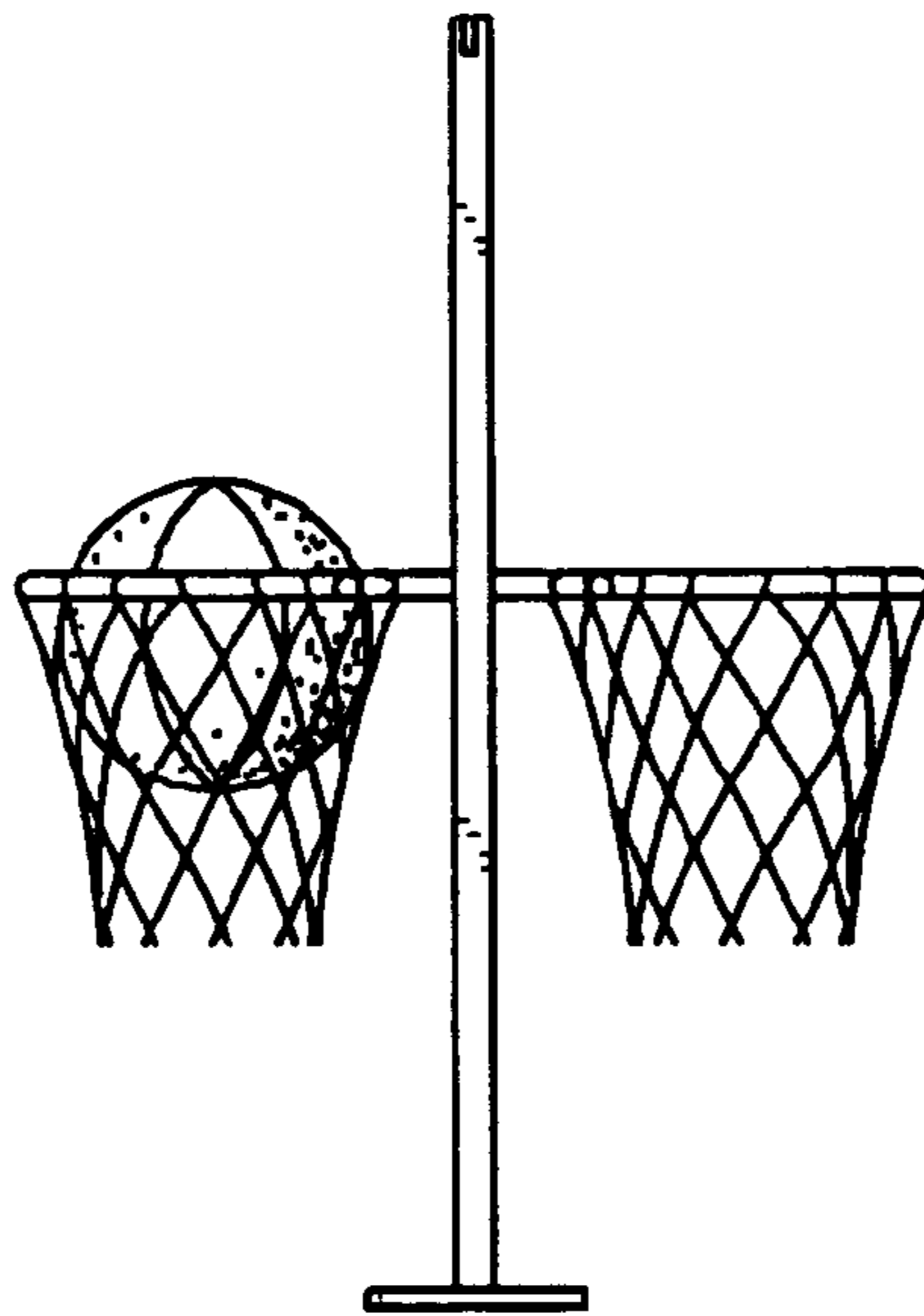

FIG. 9

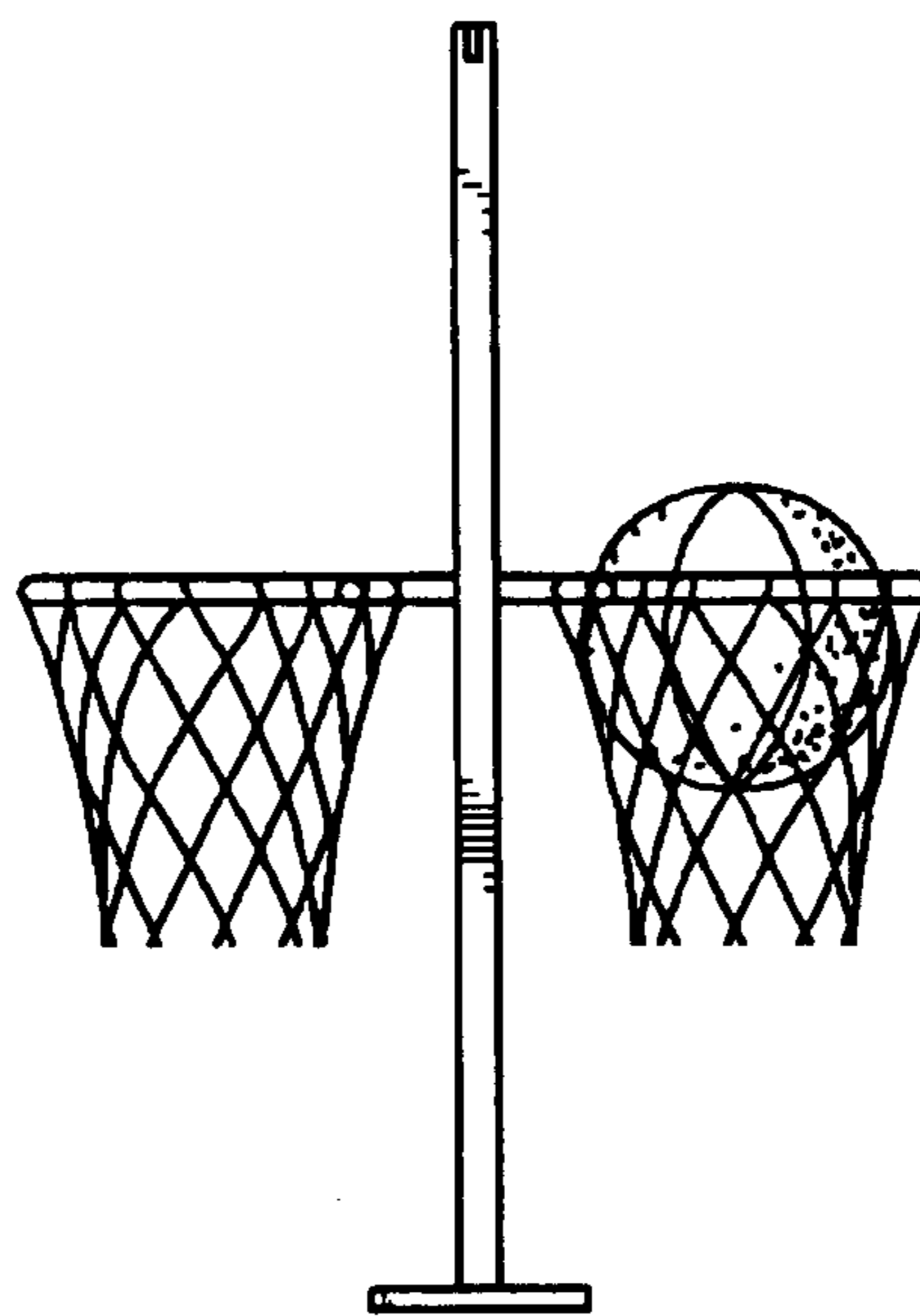

FIG. 10

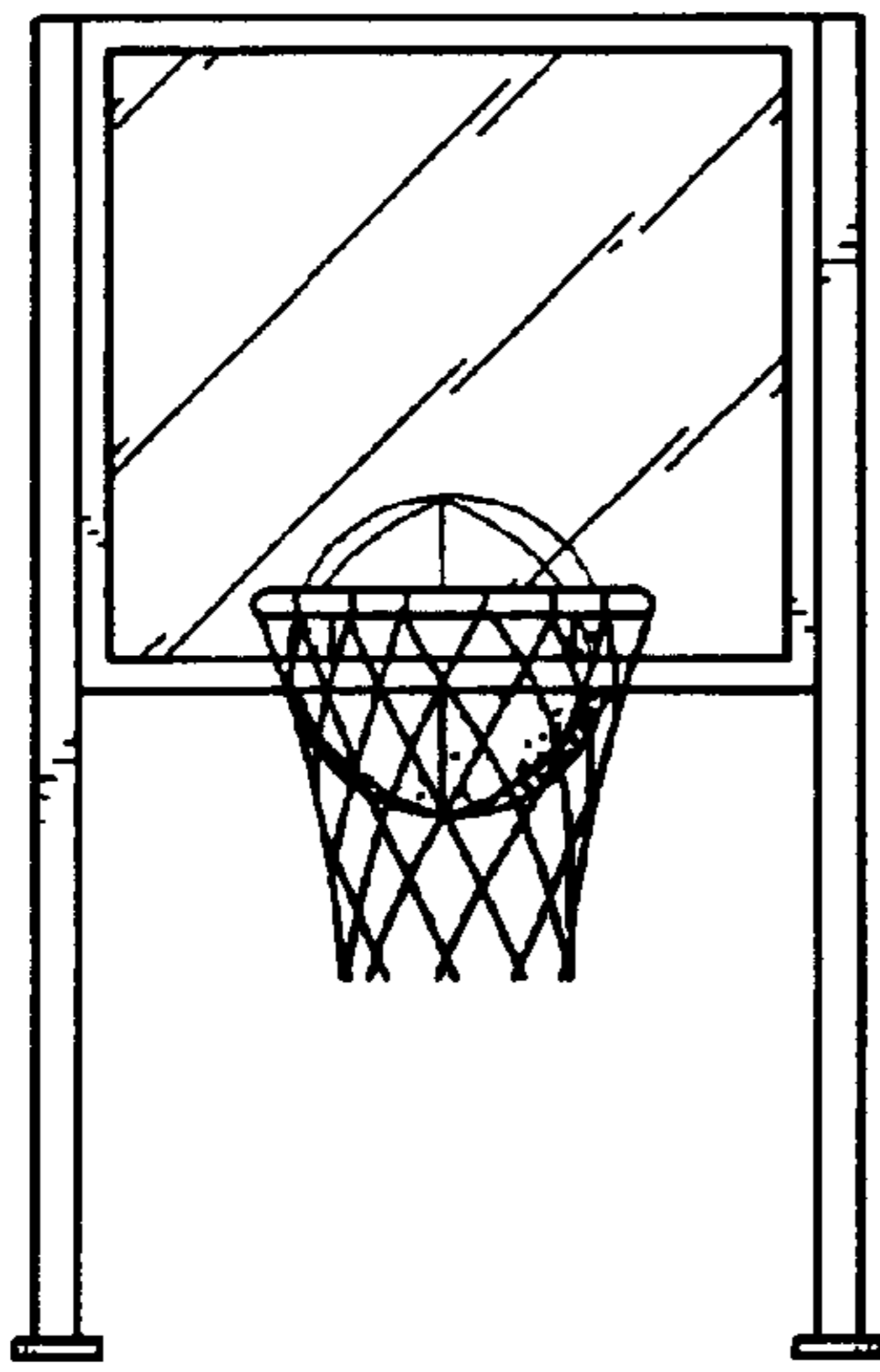

FIG. 11

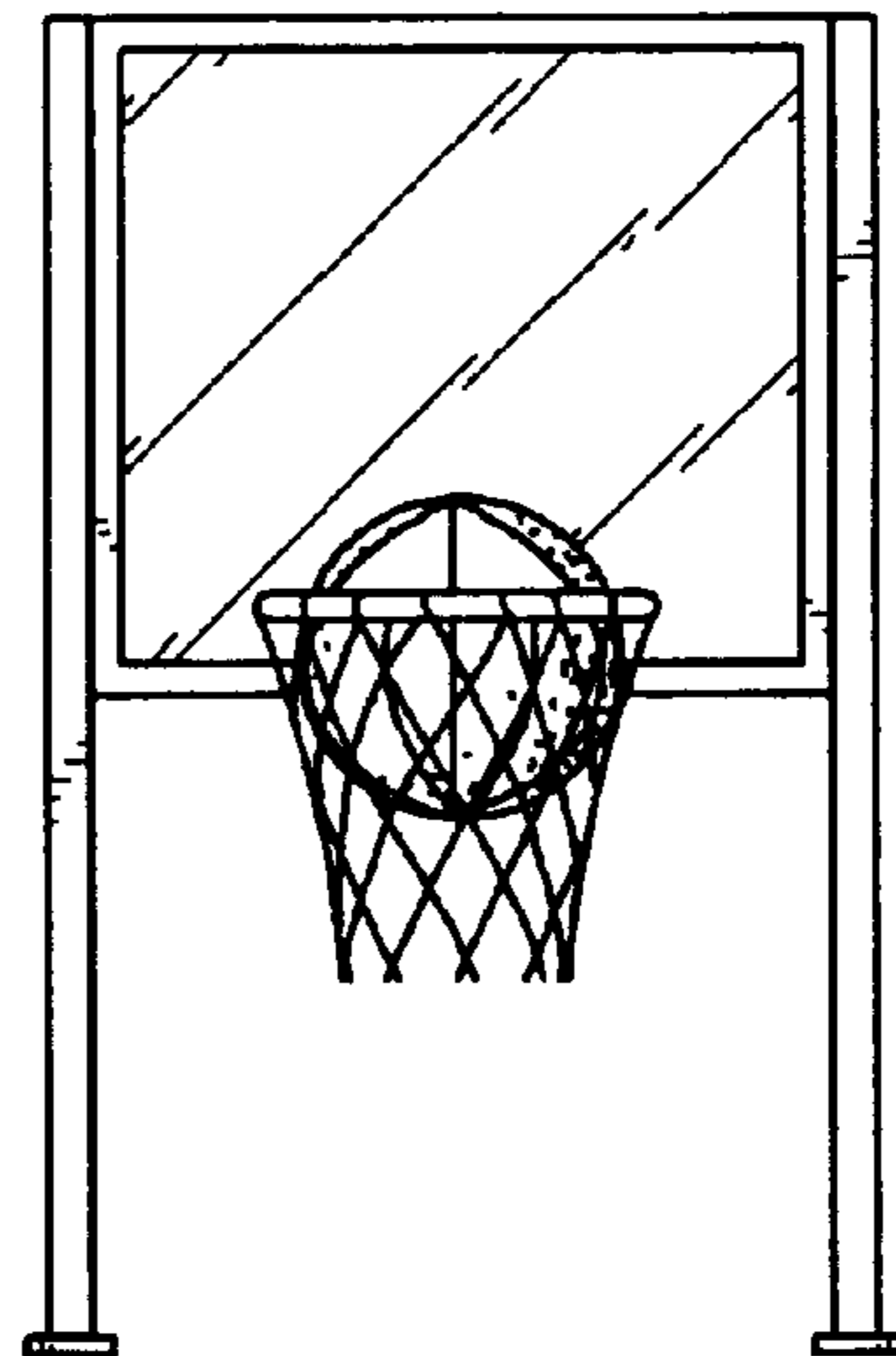

FIG. 12

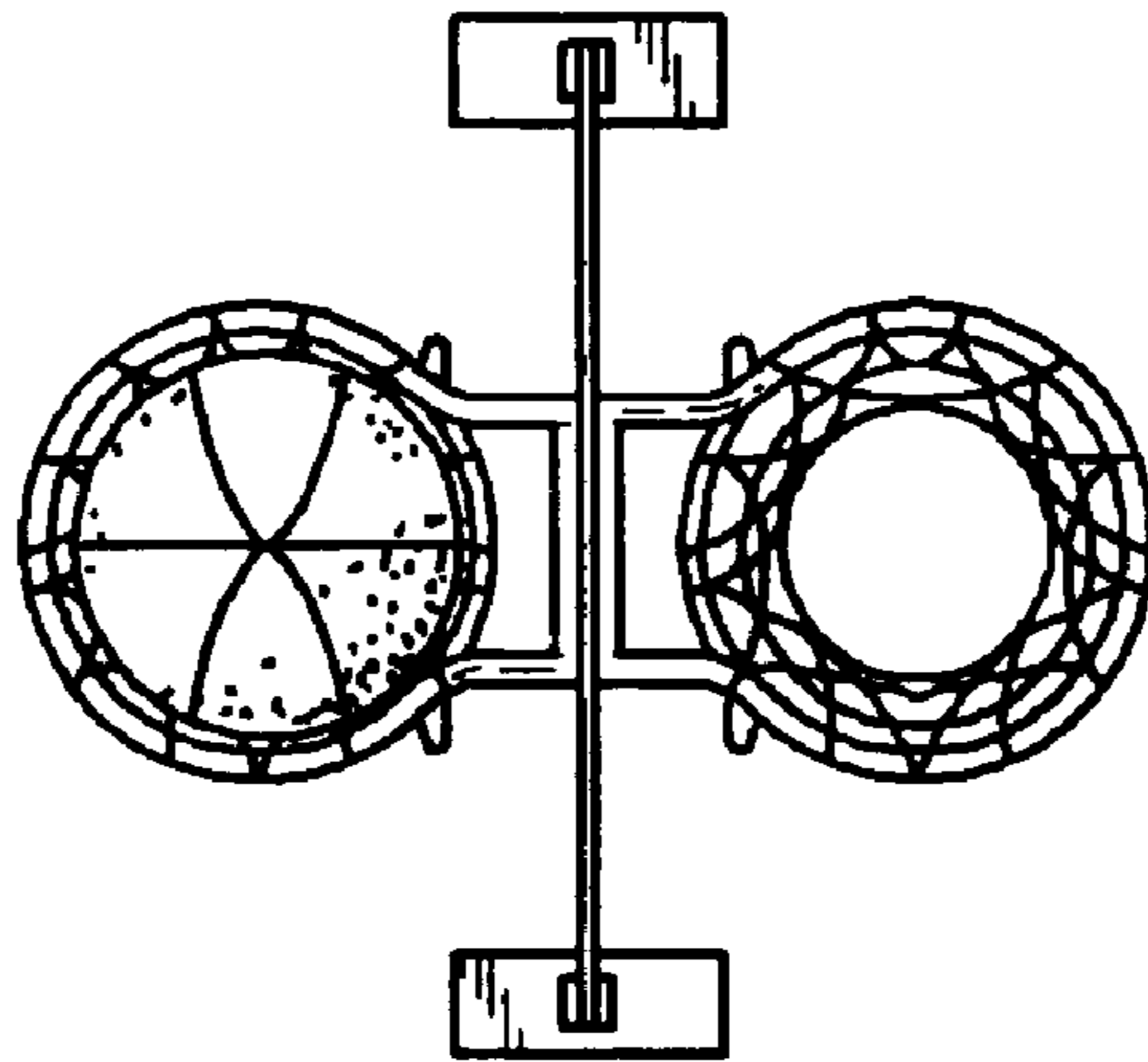

FIG. 13

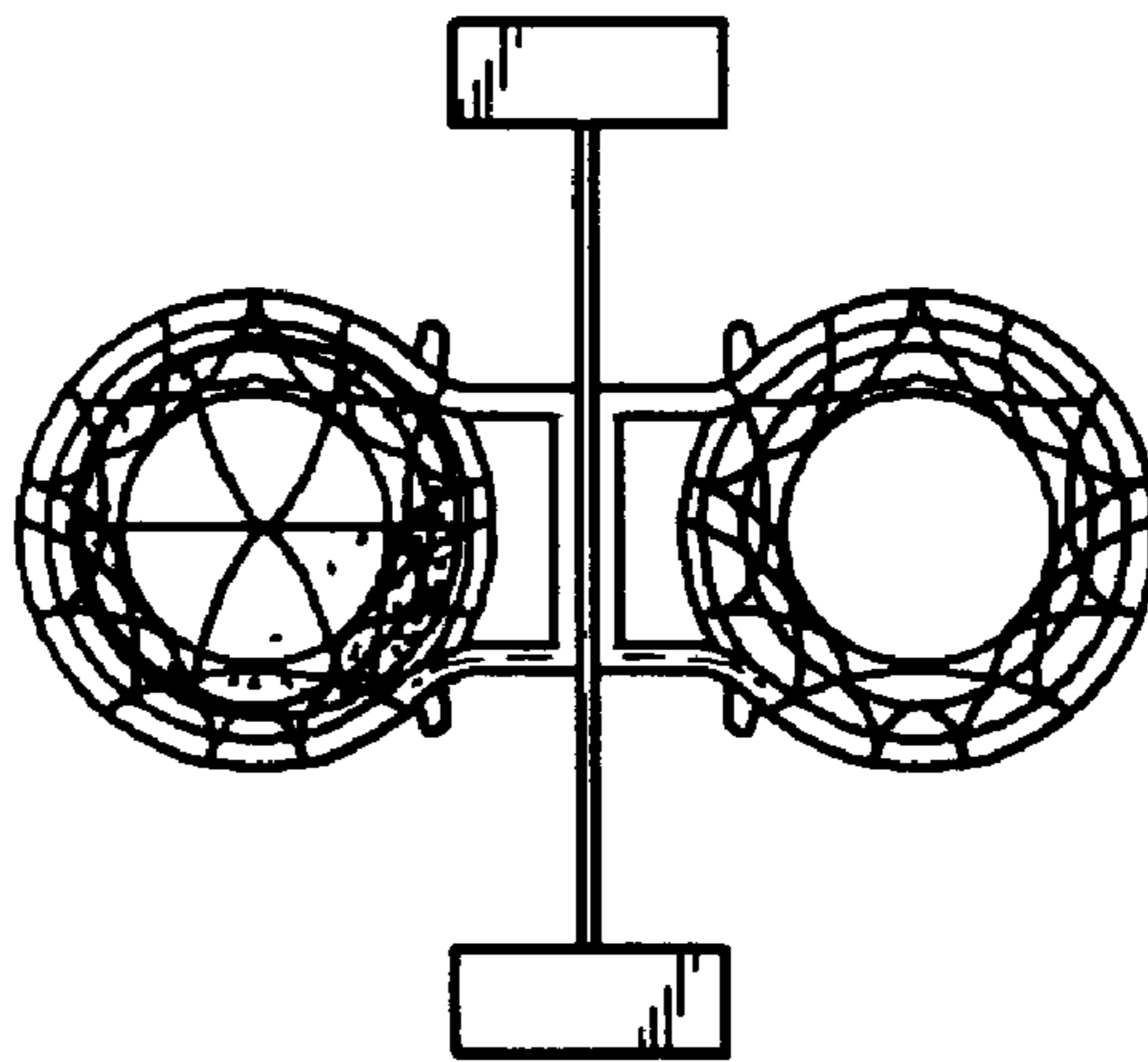

FIG. 14