



US00D482405S

(12) **United States Design Patent**  
**McIlvaine**

(10) **Patent No.:** **US D482,405 S**

(45) **Date of Patent:** **\*\* Nov. 18, 2003**

(54) **HIGH PROFILE LABEL HOLDER**

(75) Inventor: **Howard McIlvaine**, Freehold, NJ (US)

(73) Assignee: **Unex Manufacturing, Inc.**, Jackson, NJ (US)

(\*\*) Term: **14 Years**

(21) Appl. No.: **29/171,722**

(22) Filed: **Nov. 26, 2002**

(51) **LOC (7) Cl.** ..... **20-03**

(52) **U.S. Cl.** ..... **D20/43; D34/29; D34/35**

(58) **Field of Search** ..... **D20/10, 15, 40, D20/42-44, 99; D25/119, 124; D34/29, 35; 24/67 R, 67.1, 67.9; 193/35 R; 211/183; 248/346.03, 441.1**

(56) **References Cited**

**U.S. PATENT DOCUMENTS**

D141,049 S	*	5/1945	Ketchum, Jr.	.....	D25/119
2,847,776 A	*	8/1958	Robetson	.....	40/641
D189,147 S	*	11/1960	Hinchcliffe	.....	D34/29
3,164,354 A	*	1/1965	Mordock	.....	248/251
3,168,954 A	*	2/1965	Herrmann	.....	211/50
D209,071 S	*	10/1967	Koch	.....	D34/29

D209,421 S	*	11/1967	Fabian	.....	D34/29
D223,819 S	*	6/1972	Edwards	.....	D12/401
D237,104 S	*	10/1975	Fisher	.....	D25/124
D291,097 S	*	7/1987	Dalbey et al.	.....	D20/44
D330,221 S	*	10/1992	Levin	.....	D19/91
D347,449 S	*	5/1994	Garfinkle	.....	D20/43
D381,176 S	*	7/1997	Patois et al.	.....	D34/29
D441,879 S	*	5/2001	Habeck et al.	.....	D25/124
6,510,935 B1	*	1/2003	McIlvaine	.....	193/35 R

\* cited by examiner

*Primary Examiner*—Robert M. Spear

(74) *Attorney, Agent, or Firm*—Salzman & Levy

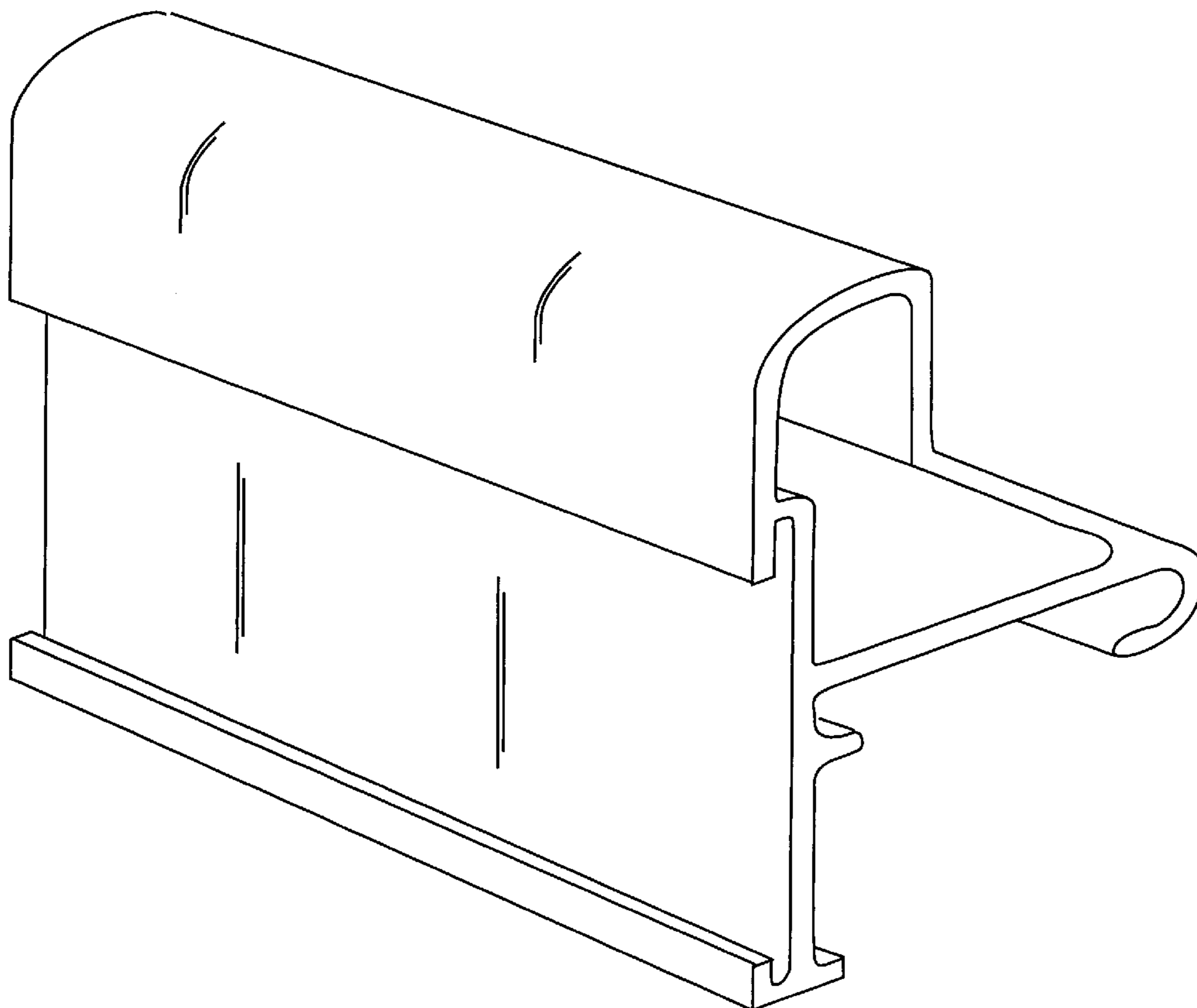
(57) **CLAIM**

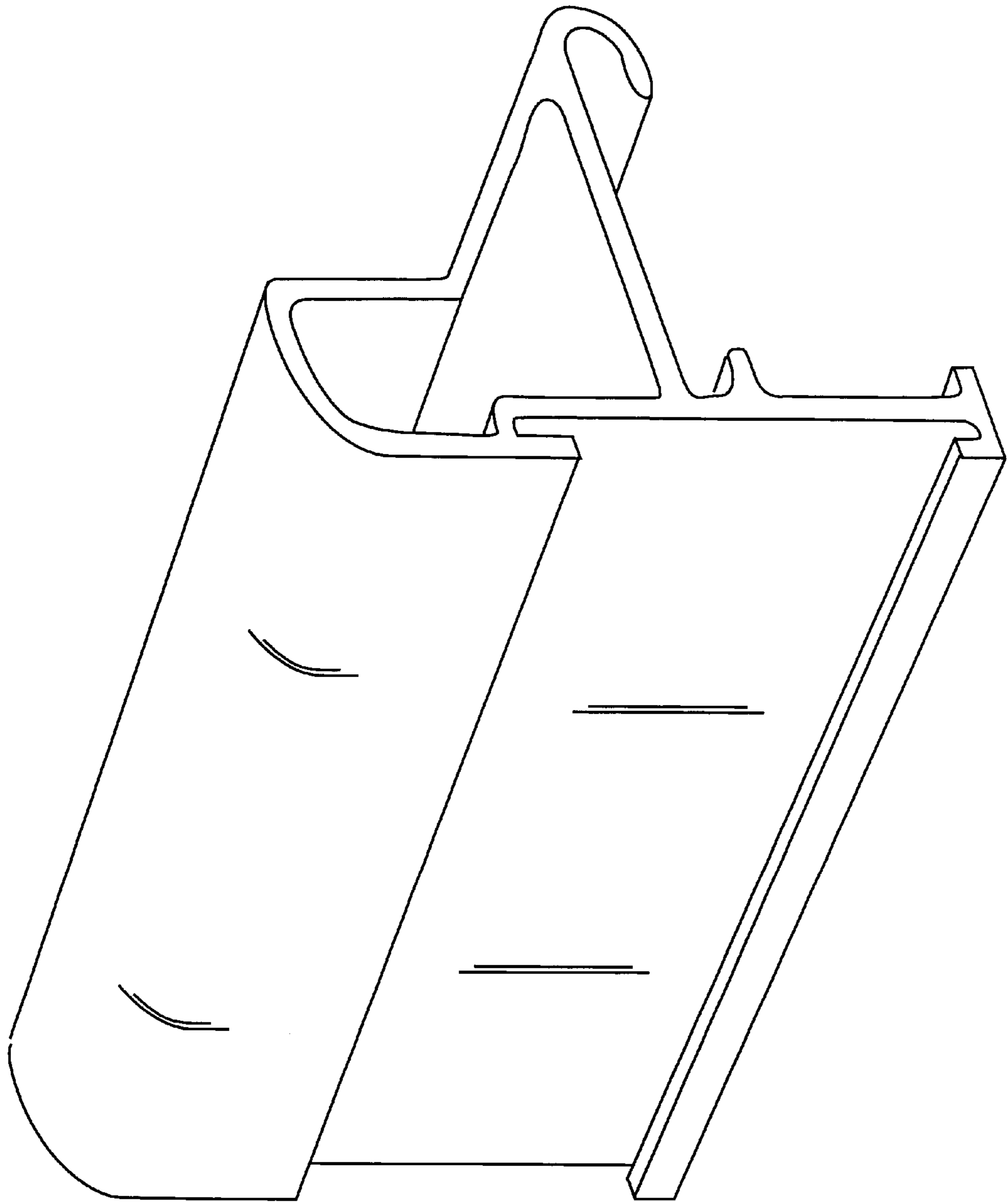
The ornamental design for high profile label holder, as shown and described.

**DESCRIPTION**

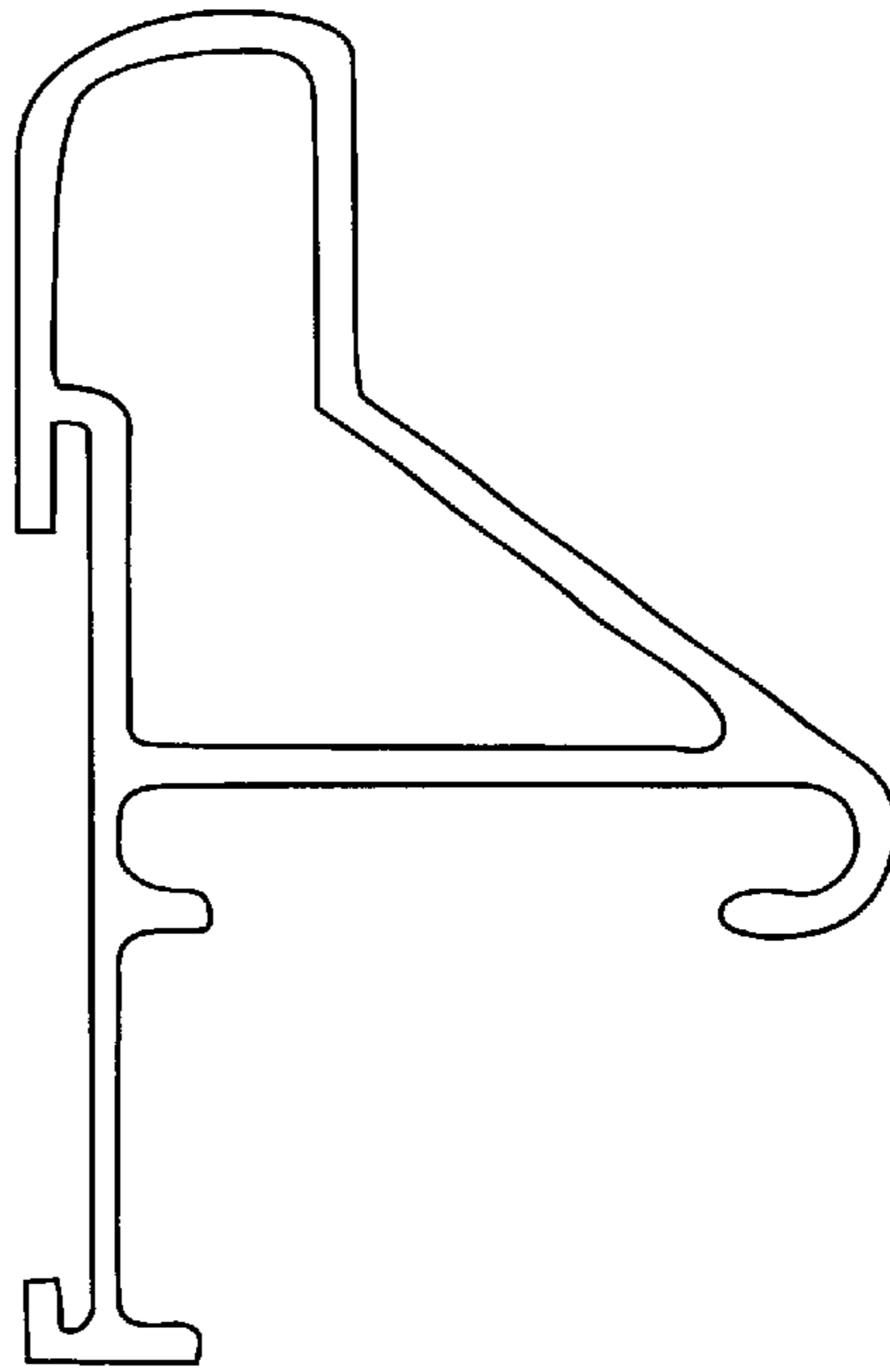
FIG. 1 is a perspective view of my high profile label holder; FIG. 2 is a right view thereof; FIG. 3 is a left view thereof; FIG. 4 is a top view thereof; FIG. 5 is a bottom view thereof; FIG. 6 is a front view thereof; and, FIG. 7 is a back view thereof.

**1 Claim, 4 Drawing Sheets**

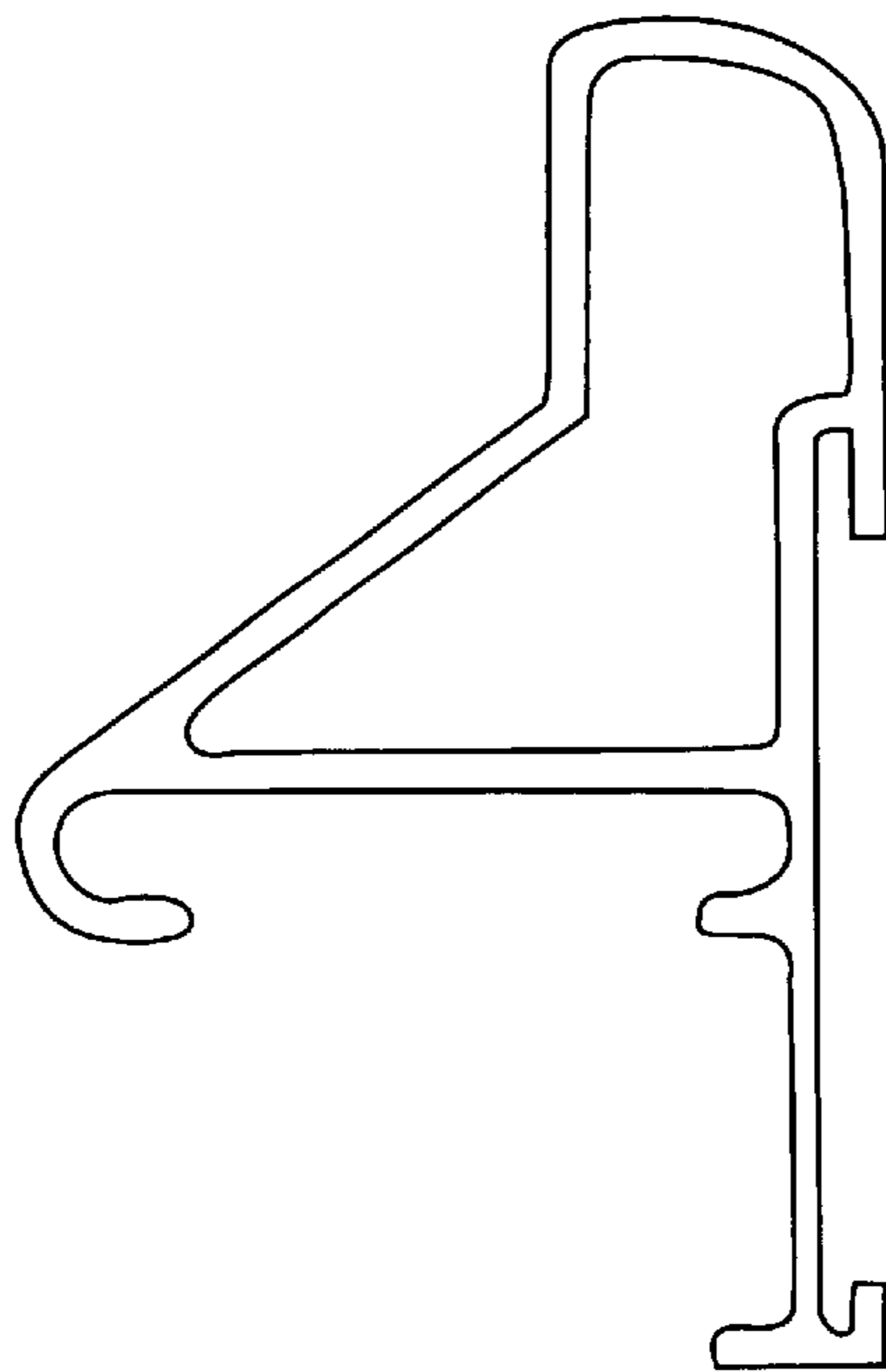




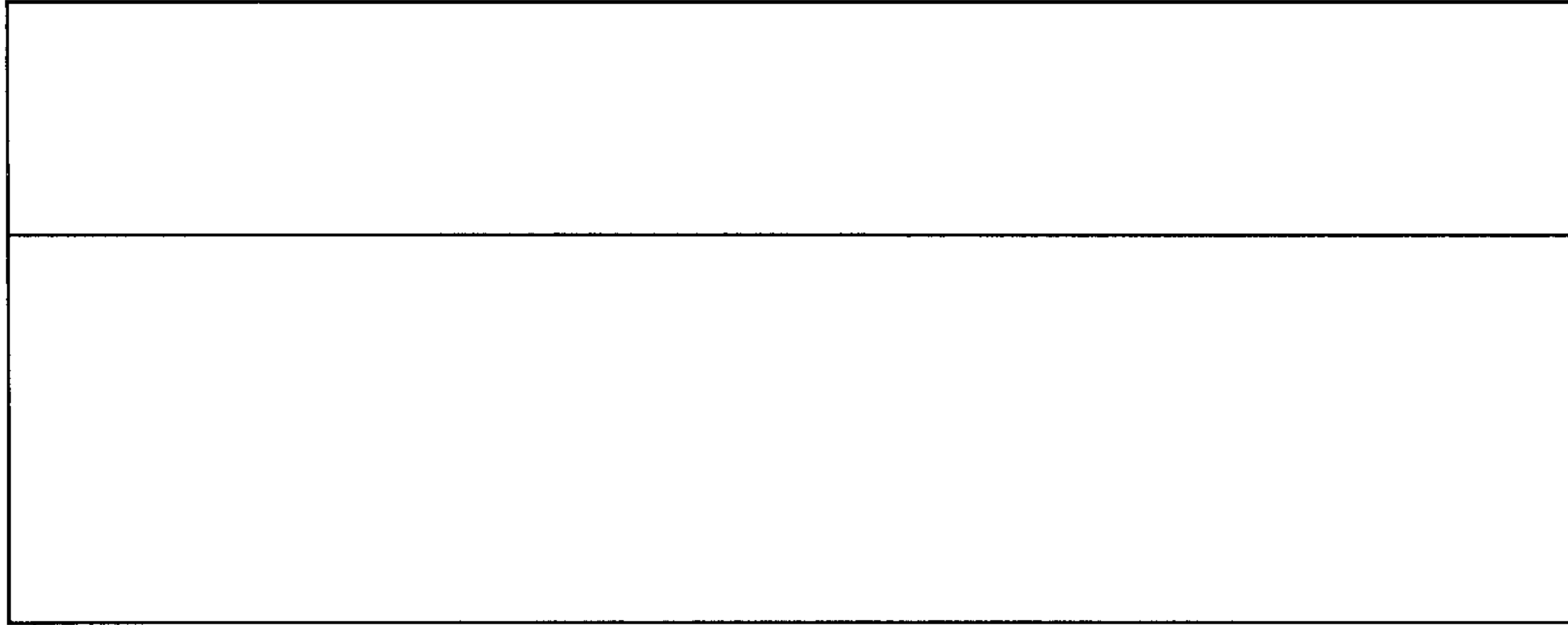
*Fig 1*



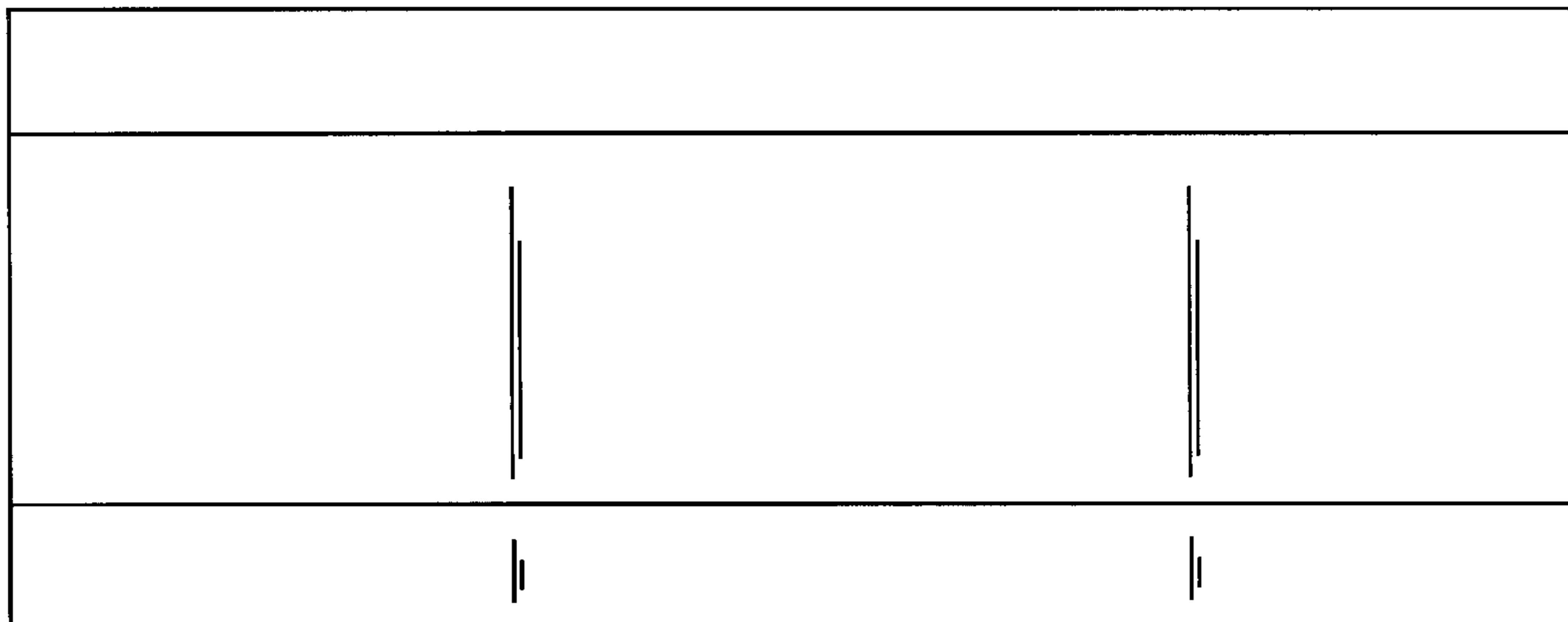
*Fig 2* (Right)



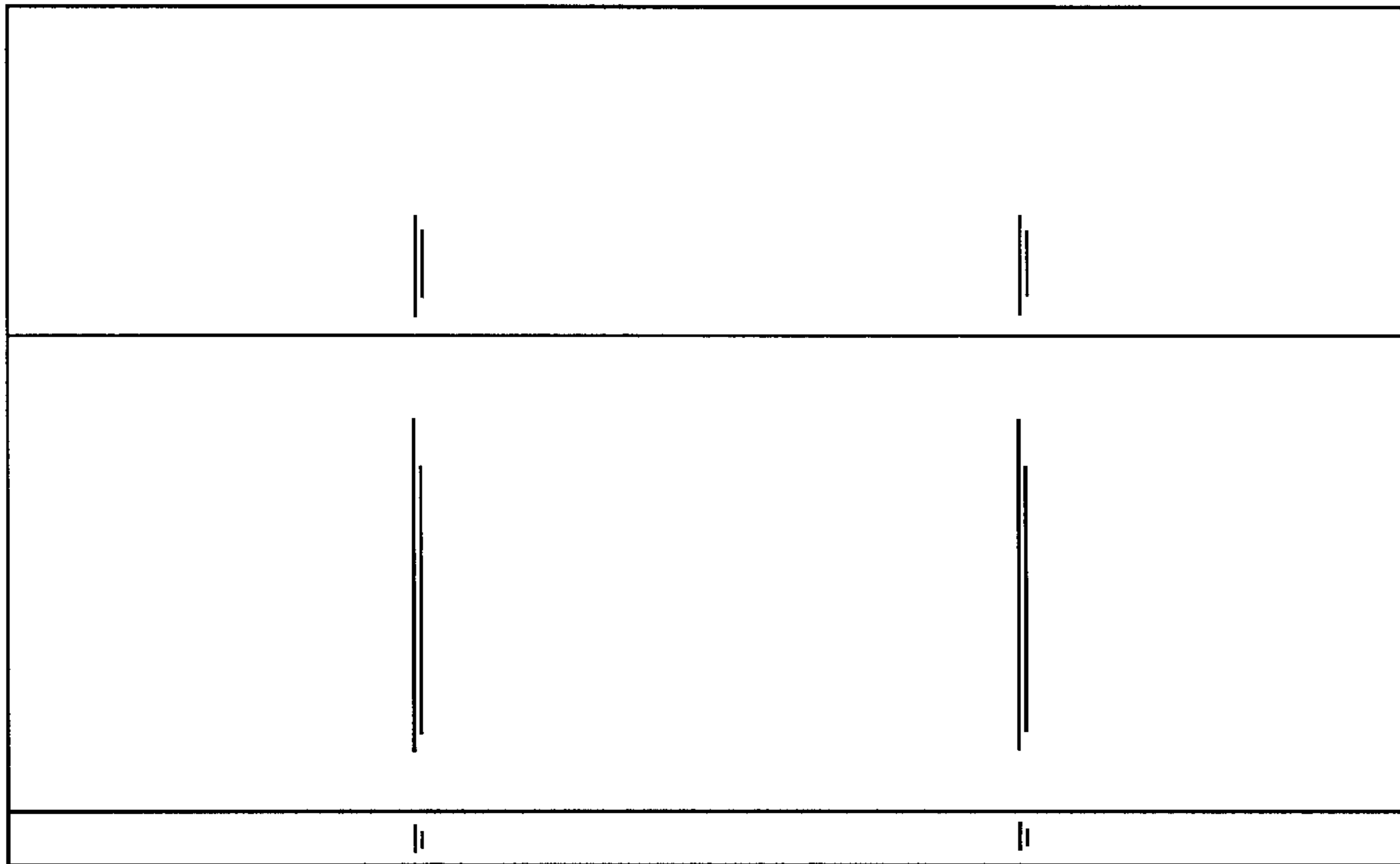
*Fig 3* (Left)



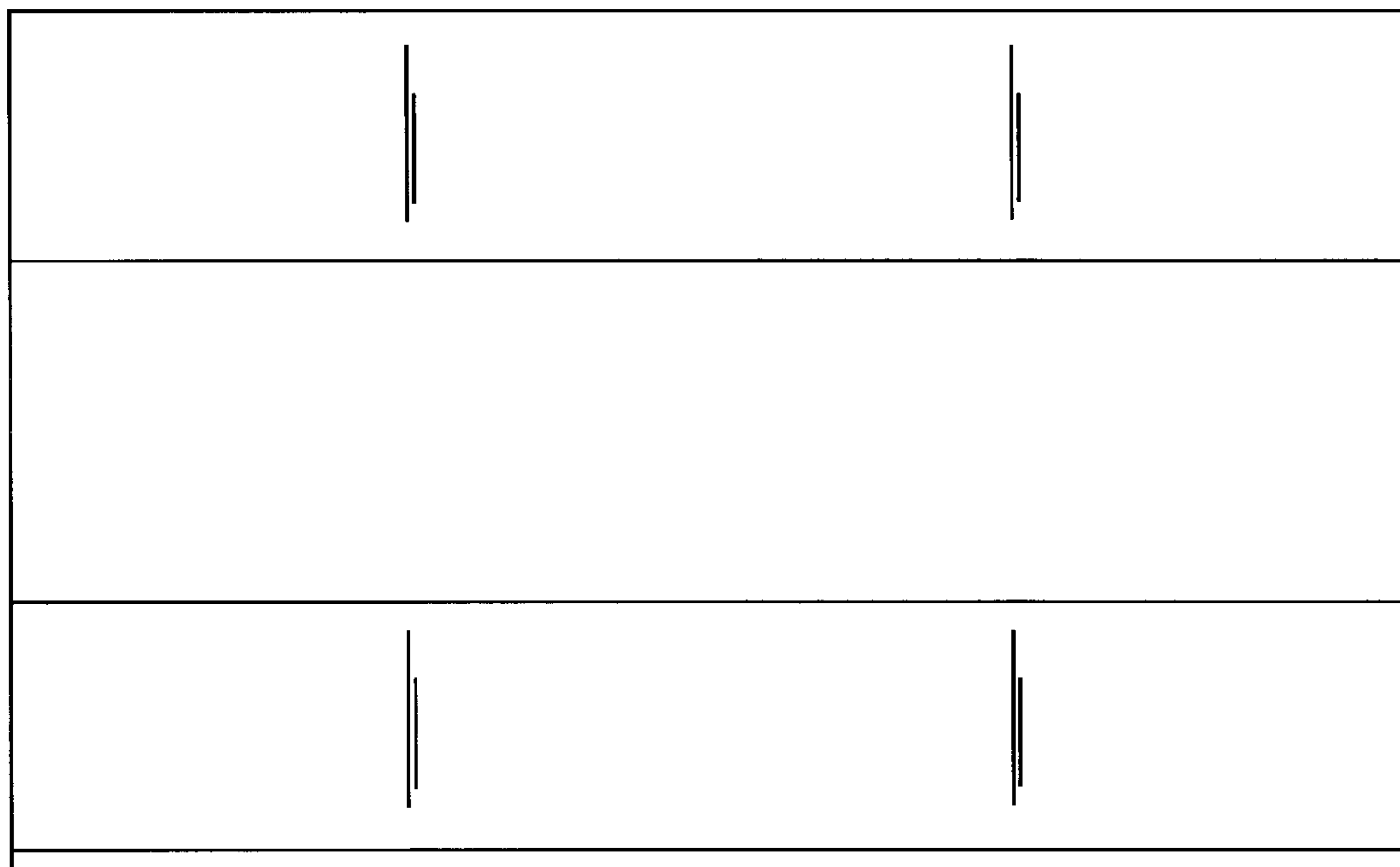
*Fig 4* (Top)



*Fig 5* (Bottom)



*Fig 6* (Front)



*Fig 7* (Back)