



US00D482404S

(12) **United States Design Patent**  
**McIlvaine**

(10) **Patent No.:** **US D482,404 S**

(45) **Date of Patent:** **\*\* Nov. 18, 2003**

(54) **IMPACT RESISTANT LABEL HOLDER**

(75) Inventor: **Howard McIlvaine**, Freehold, NJ (US)

(73) Assignee: **Unex Manufacturing, Inc.**, Jackson, NJ (US)

(\*\*) Term: **14 Years**

(21) Appl. No.: **29/171,721**

(22) Filed: **Nov. 26, 2002**

(51) **LOC (7) Cl.** ..... **20-03**

(52) **U.S. Cl.** ..... **D20/43; D34/29; D34/35**

(58) **Field of Search** ..... **D20/10, 15, 40, D20/42-44, 99; D25/119, 124; D34/29, 35; 24/67 R, 67.1, 67.9; 193/35 R; 211/183; 248/346.03, 441.1**

(56) **References Cited**

**U.S. PATENT DOCUMENTS**

- D141,049 S \* 5/1945 Ketchum, Jr. .... D25/119
- 3,164,354 A \* 1/1965 Murdock ..... 248/251
- D223,819 S \* 6/1972 Edwards ..... D12/401
- D237,104 S \* 10/1975 Fisher ..... D25/124

- D291,097 S \* 7/1987 Dalbey et al. .... D20/44
- D324,575 S \* 3/1992 Davis ..... D25/119
- D347,449 S \* 5/1994 Grafinkle ..... D20/43
- D441,879 S \* 5/2001 Habeck et al. .... D25/124
- 6,510,935 B1 \* 1/2003 McIlvaine ..... 193/35 R

\* cited by examiner

*Primary Examiner*—Robert M. Spear

(74) *Attorney, Agent, or Firm*—Salzman & Levy

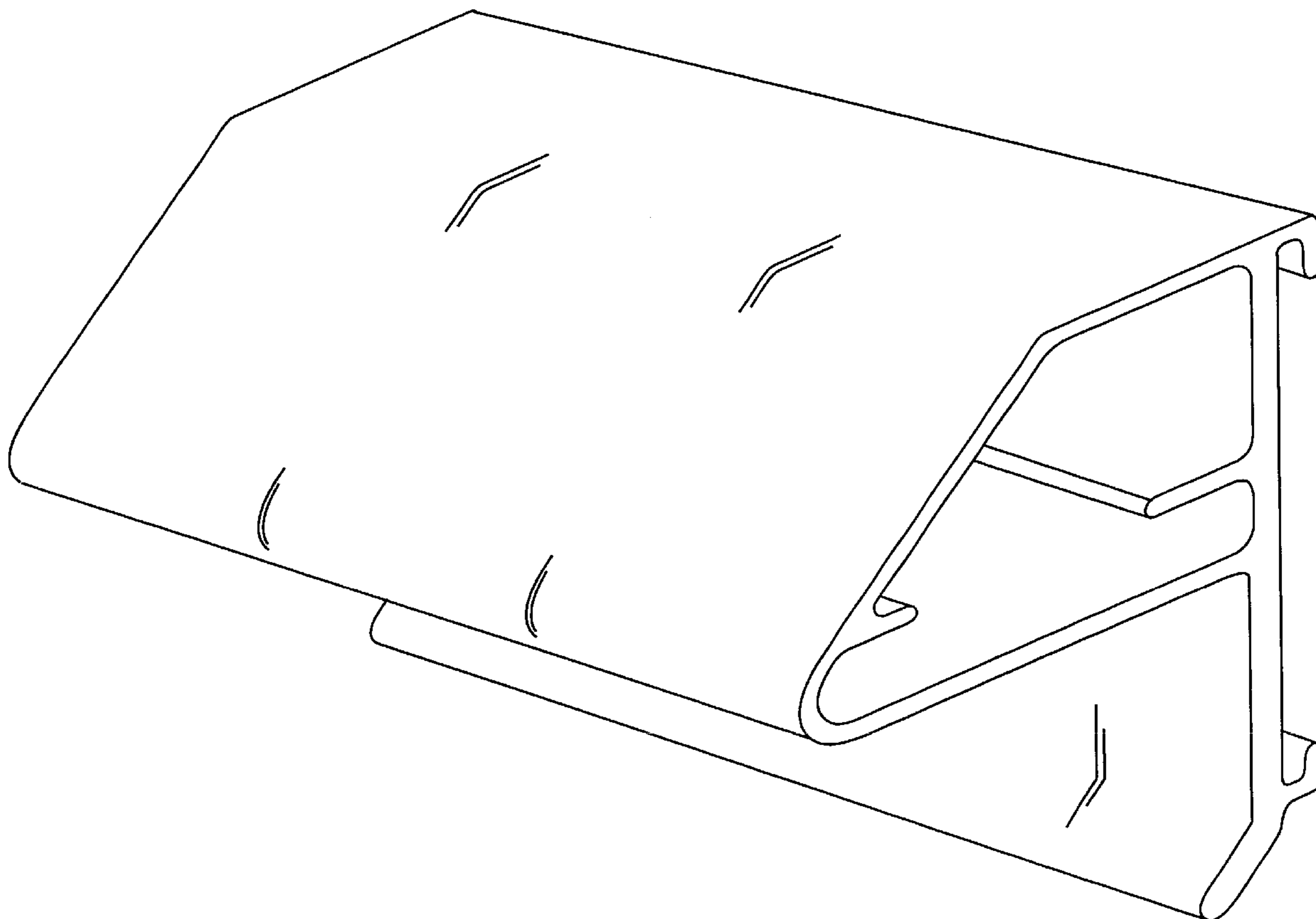
(57) **CLAIM**

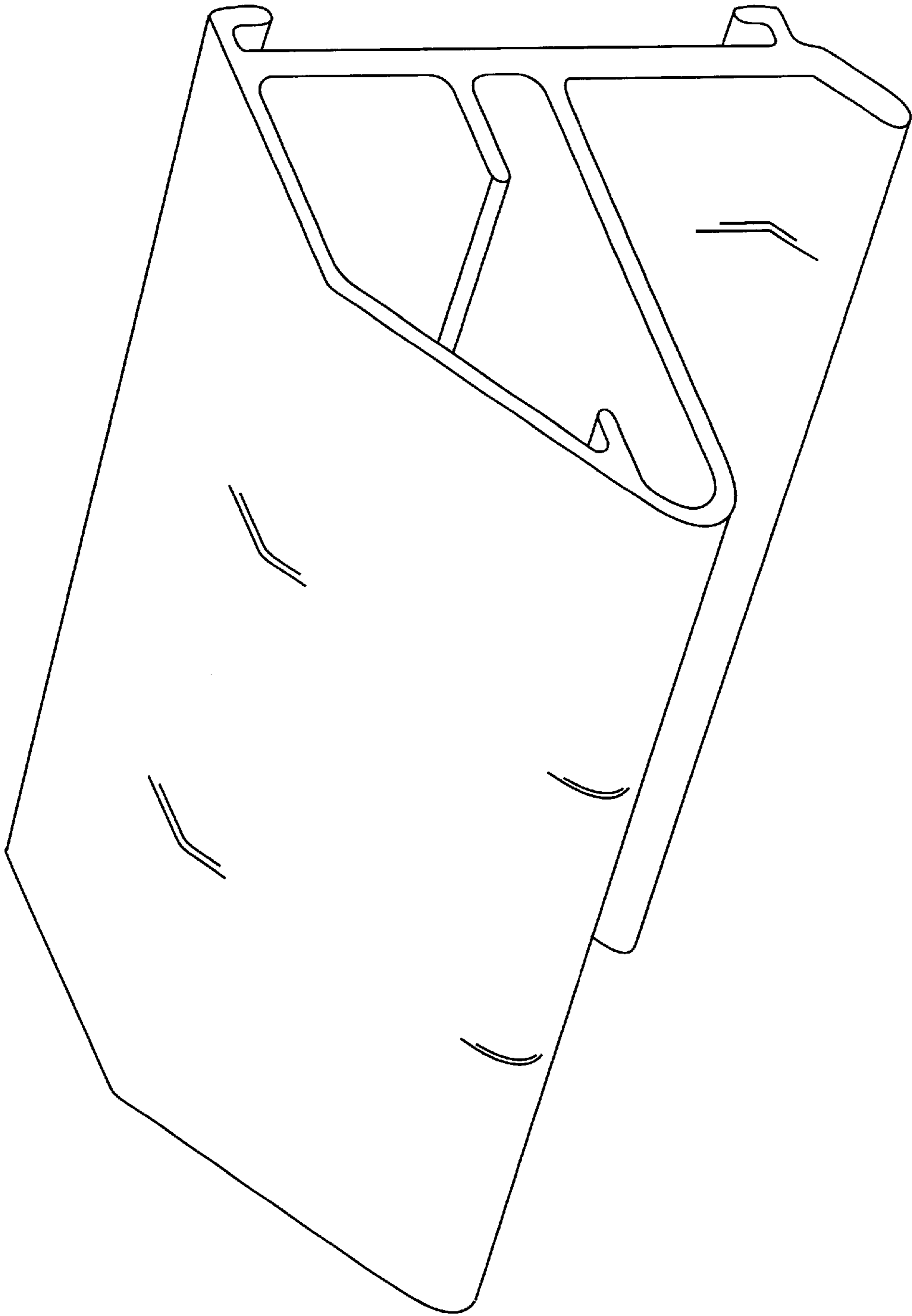
The ornamental design for impact resistant label holder, as shown and described.

**DESCRIPTION**

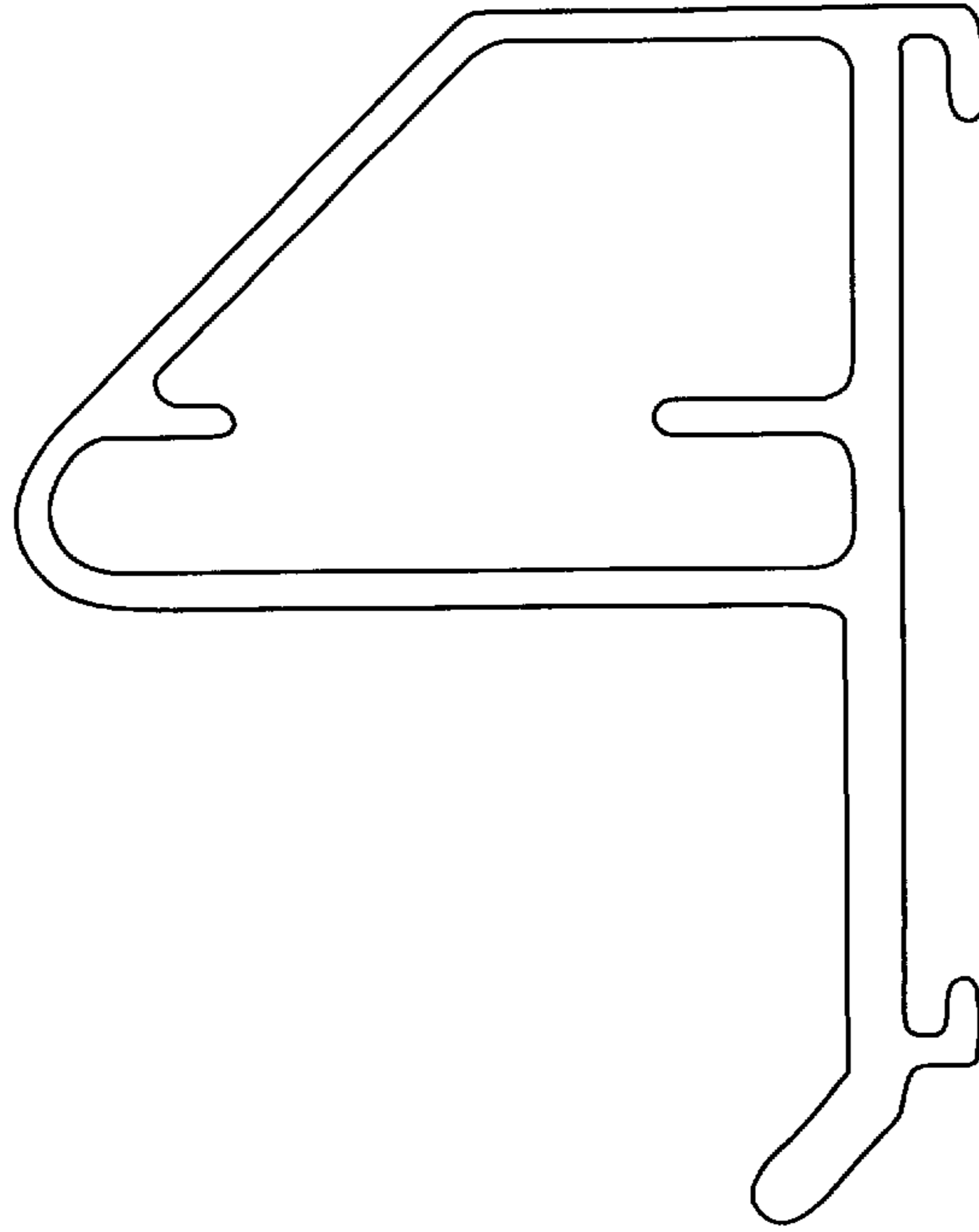
- FIG. 1 is a perspective view of my impact resistant label holder;
- FIG. 2 is a right view thereof;
- FIG. 3 is a left view thereof;
- FIG. 4 is a top view thereof;
- FIG. 5 is a bottom view thereof;
- FIG. 6 is a front view thereof; and,
- FIG. 7 is a back view thereof.

**1 Claim, 4 Drawing Sheets**

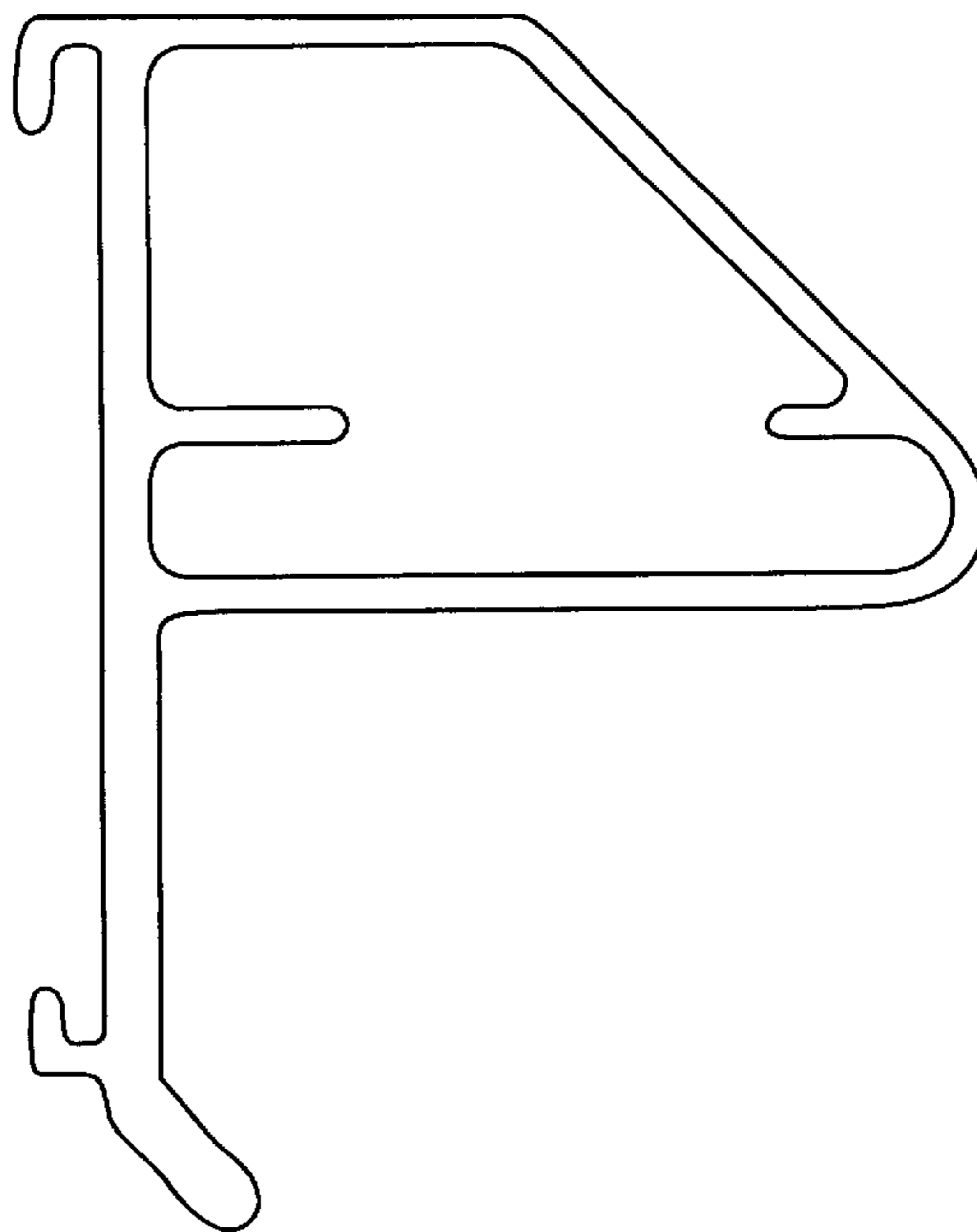




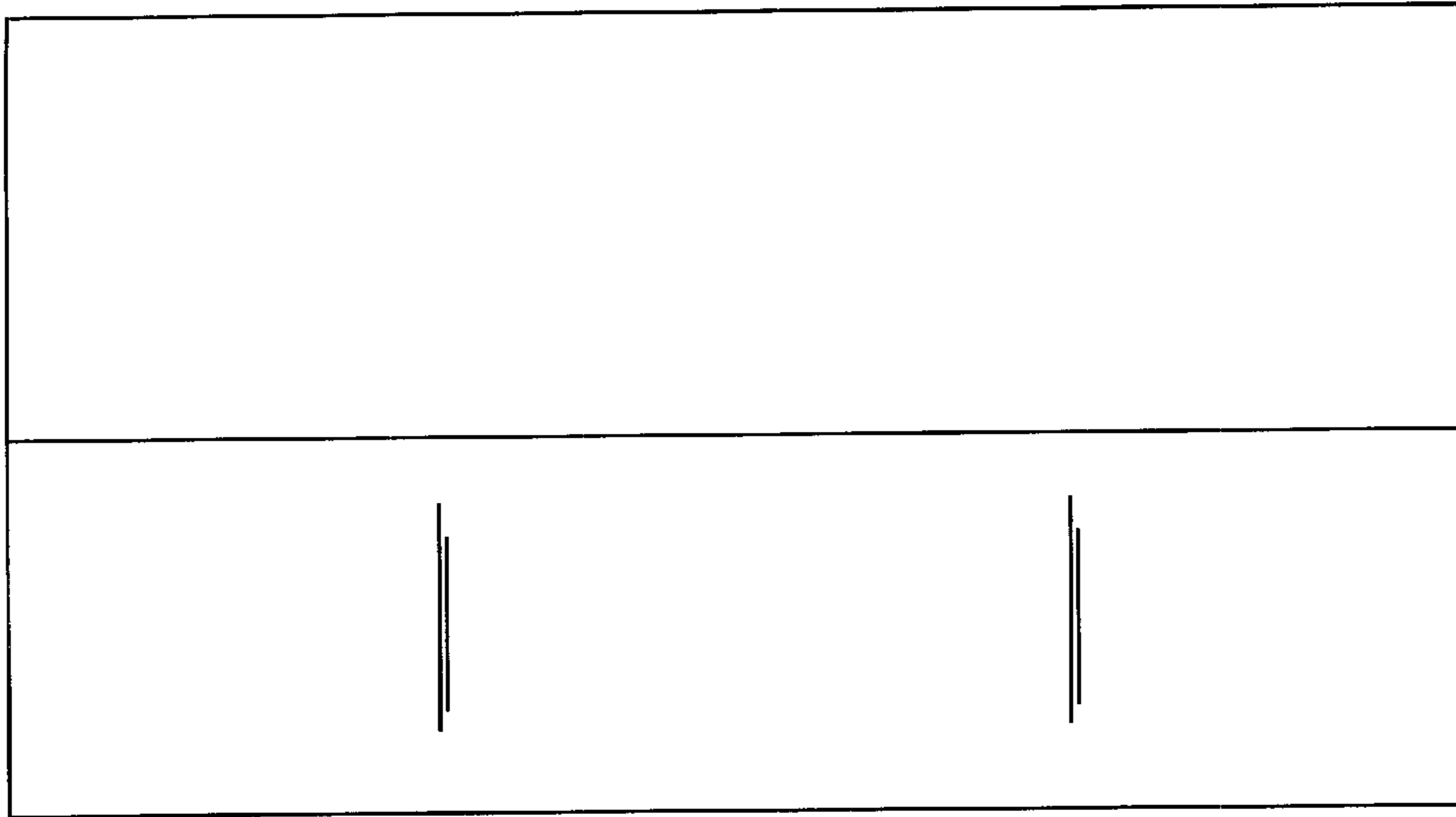
*Fig. 1*



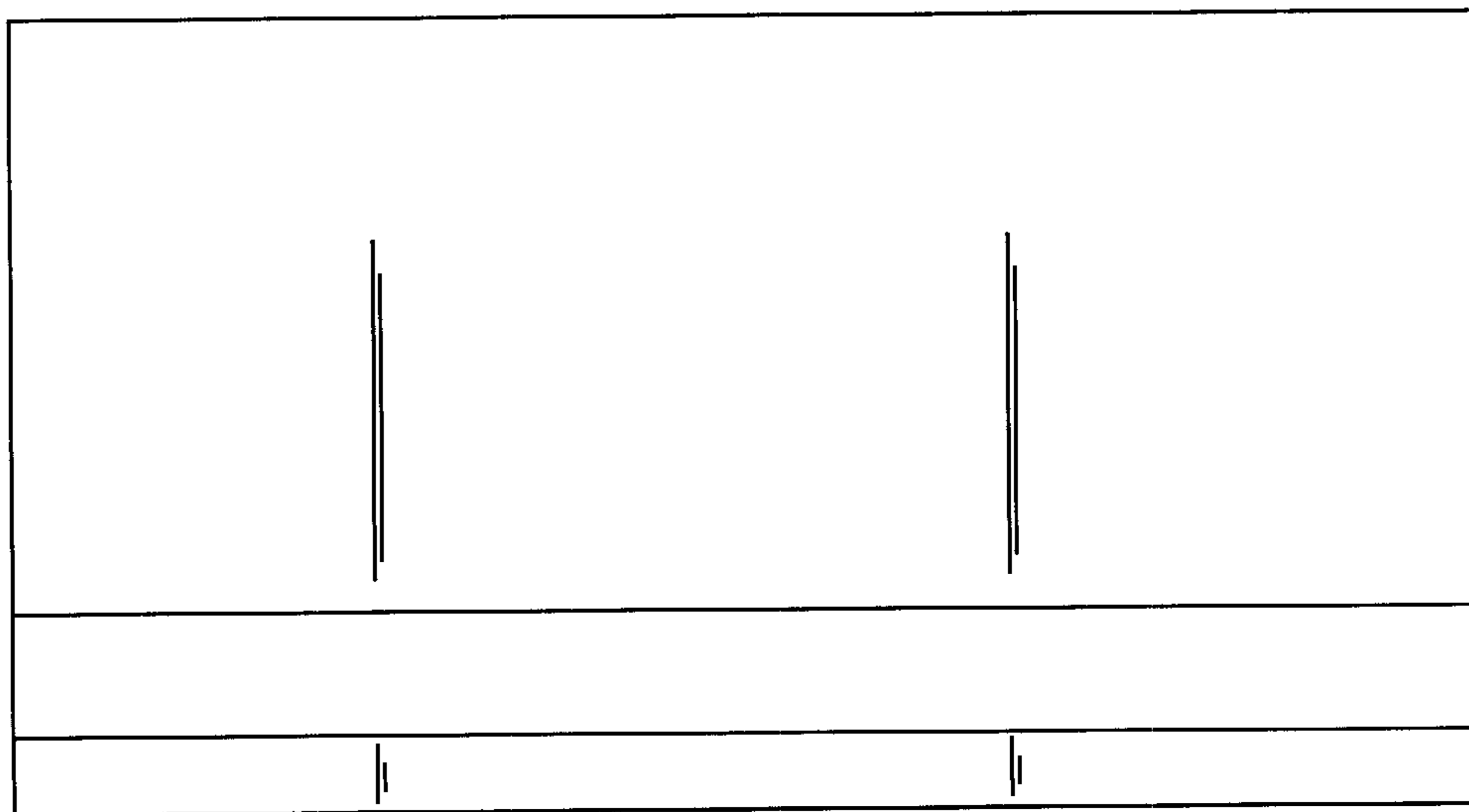
*Fig.2* (Right)



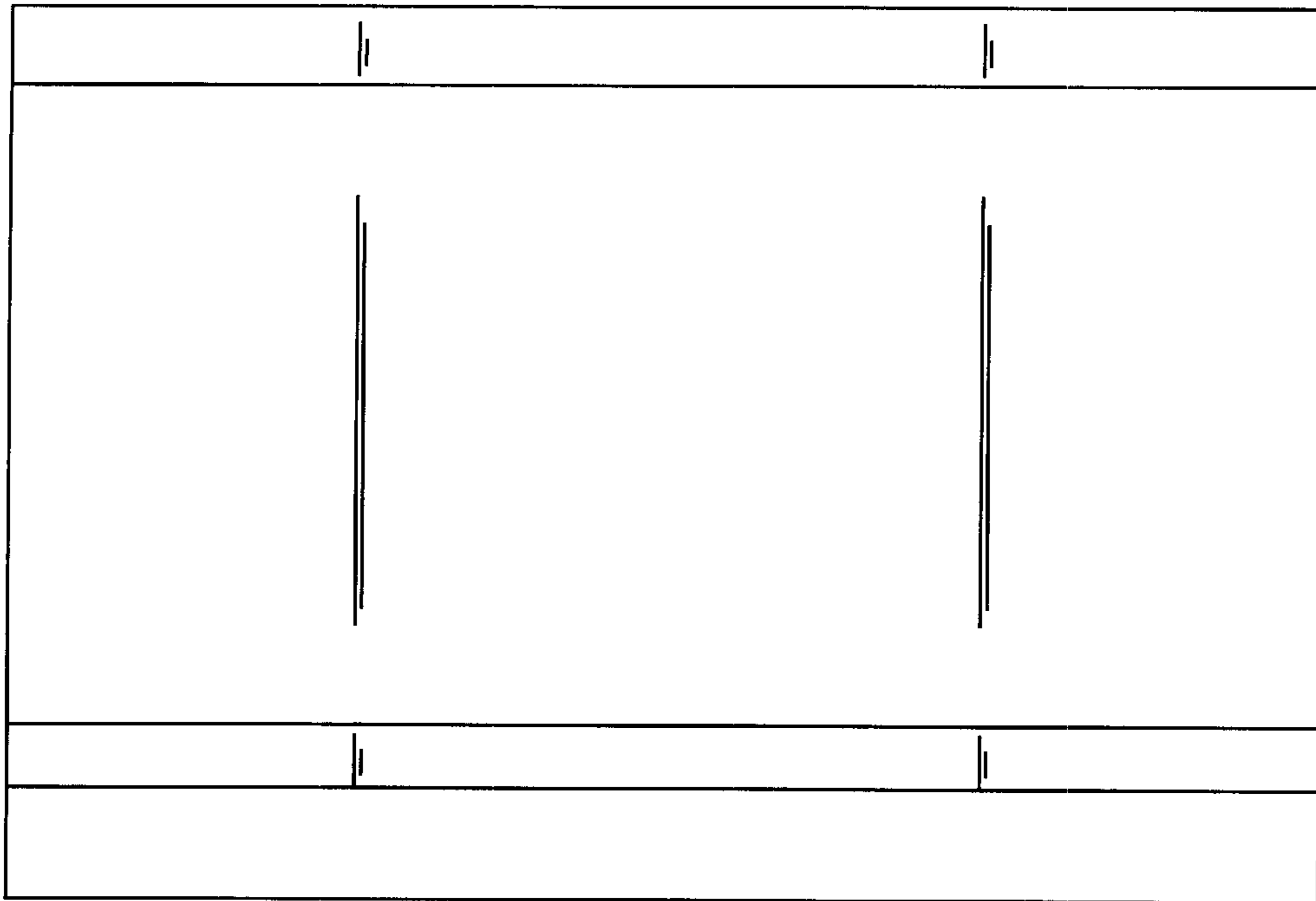
*Fig.3* (Left)



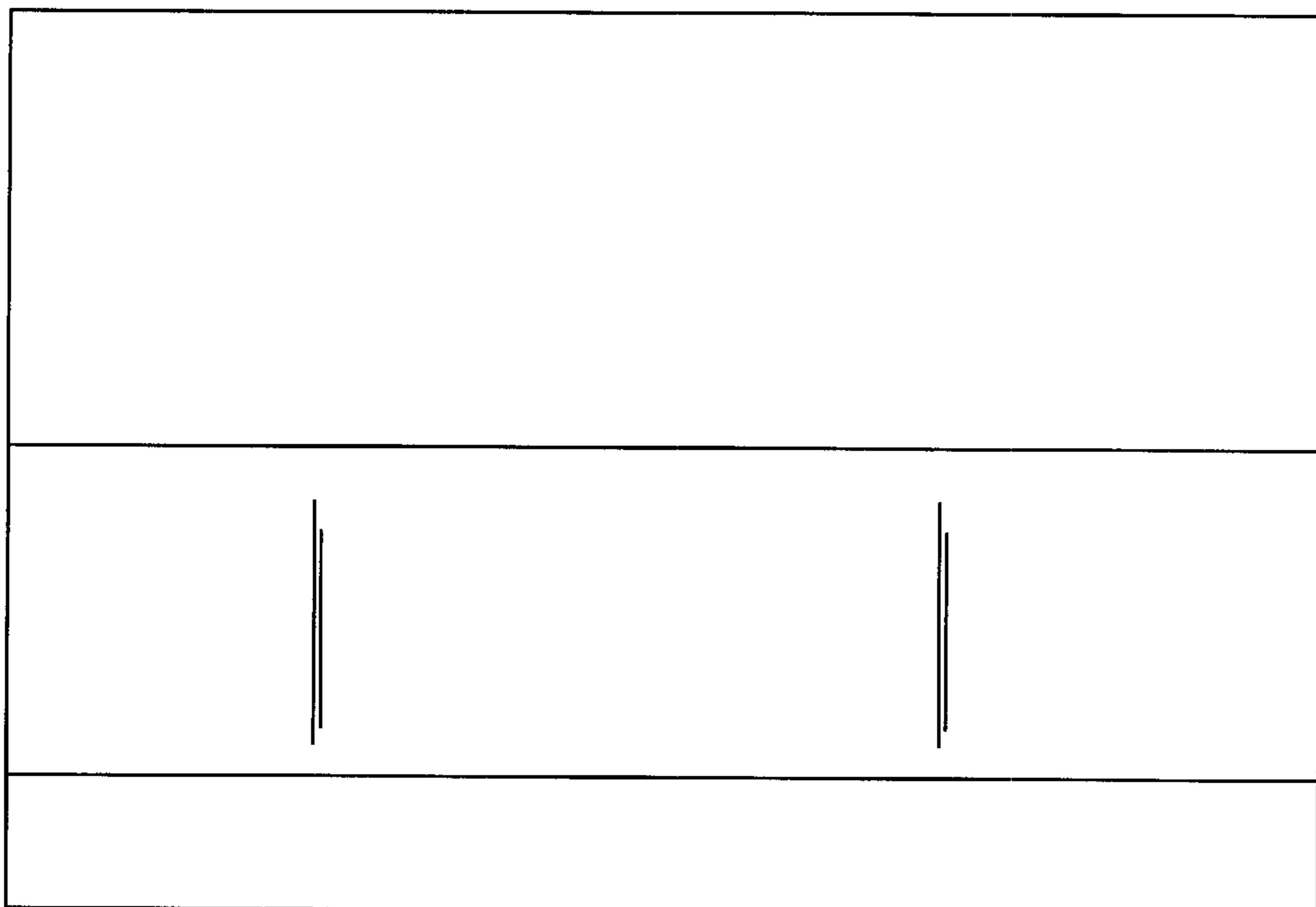
*Fig.4* (Top)



*Fig.5* (Bottom)



*Fig. 6* (Front)



*Fig. 7* (Back)