



US00D482353S

(12) **United States Design Patent**
Helin

(10) **Patent No.:** **US D482,353 S**

(45) **Date of Patent:** **** Nov. 18, 2003**

(54) **FRONT COVER FOR A HANDSET**

(75) Inventor: **Totti Helin**, Helsinki (FI)

(73) Assignee: **Nokia Corporation**, Espoo (FI)

(**) Term: **14 Years**

(21) Appl. No.: **29/157,203**

(22) Filed: **Mar. 15, 2002**

(30) **Foreign Application Priority Data**

Sep. 17, 2001 (FI) M20010619

(51) **LOC (7) Cl.** **14-03**

(52) **U.S. Cl.** **D14/248**

(58) **Field of Search** D14/137, 240,
D14/138, 218, 217, 147-148, 249, 247-248,
441, 144, 191, 454-456, 341-347, 338-340;
379/433.01-433.13, 419, 434, 428.01-428.04,
420.01-420.04, 440, 364, 368-370; 455/550-575,
90; D24/517, 329, 331, 333; D13/103,
119, 168, 171, 174; 345/168, 169; D18/2,
7, 12.2, 12.3

(56) **References Cited**

U.S. PATENT DOCUMENTS

- D257,560 S * 11/1980 Jang D14/347
- D293,241 S 12/1987 Wan et al.
- D298,623 S 11/1988 Yubisui et al.
- D299,464 S 1/1989 Shiozawa et al.
- D301,882 S * 6/1989 Watanabe D14/140
- D302,265 S 7/1989 Siegner et al.
- 4,969,647 A * 11/1990 Mical et al. 463/31
- D320,624 S * 10/1991 Taylor D21/331
- 5,161,803 A * 11/1992 Ohara 463/44
- D332,804 S * 1/1993 Li D21/331
- 5,189,632 A * 2/1993 Paajanen et al. 708/109
- D337,764 S 7/1993 Paton et al.
- D338,045 S * 8/1993 Rosen D14/400
- D347,856 S * 6/1994 Marfori et al. D19/60
- D367,043 S * 2/1996 Ross et al. D14/346
- D373,137 S * 8/1996 Nakada D17/24
- D377,166 S 1/1997 Jones et al.

- D377,341 S 1/1997 Imai et al.
- D378,514 S 3/1997 Kruse
- D379,971 S 6/1997 Jones et al.
- 5,644,338 A * 7/1997 Bowen 345/168
- D382,545 S 8/1997 Imai et al.
- D382,914 S * 8/1997 Ho et al. D21/331
- D386,497 S * 11/1997 Huslig et al. D14/191
- D389,838 S * 1/1998 Brunner et al. D14/218
- 5,719,936 A * 2/1998 Hillenmayer 379/447
- D392,968 S * 3/1998 Johansson D14/144
- D393,629 S * 4/1998 Tsui D13/168
- D393,834 S 4/1998 Margalit et al.
- D395,250 S * 6/1998 Kabler et al. D10/65
- D398,307 S 9/1998 Collins
- D401,914 S 12/1998 Kamegi
- D402,664 S * 12/1998 Phillips et al. D14/247
- D410,633 S * 6/1999 Tsui D13/168
- D412,017 S * 7/1999 Sramek et al. D21/329
- D413,597 S 9/1999 Oba

(List continued on next page.)

FOREIGN PATENT DOCUMENTS

AU 143671 4/2001

Primary Examiner—Jeffrey Asch

(74) *Attorney, Agent, or Firm*—Banner & Witcoff, Ltd.

(57) **CLAIM**

The ornamental design for a front cover for a handset, as shown and described.

DESCRIPTION

FIG. 1 is a bottom view of a front cover for a handset showing my new design;
FIG. 2 is a front view thereof;
FIG. 3 is a top view thereof;
FIG. 4 is a right side view thereof;
FIG. 5 is a left side view thereof; and,
FIG. 6 is a perspective front view thereof.
The broken line showing of the internal surfaces and the extending tabs is for illustrative purposes only and forms no part of the claimed design.

1 Claim, 2 Drawing Sheets

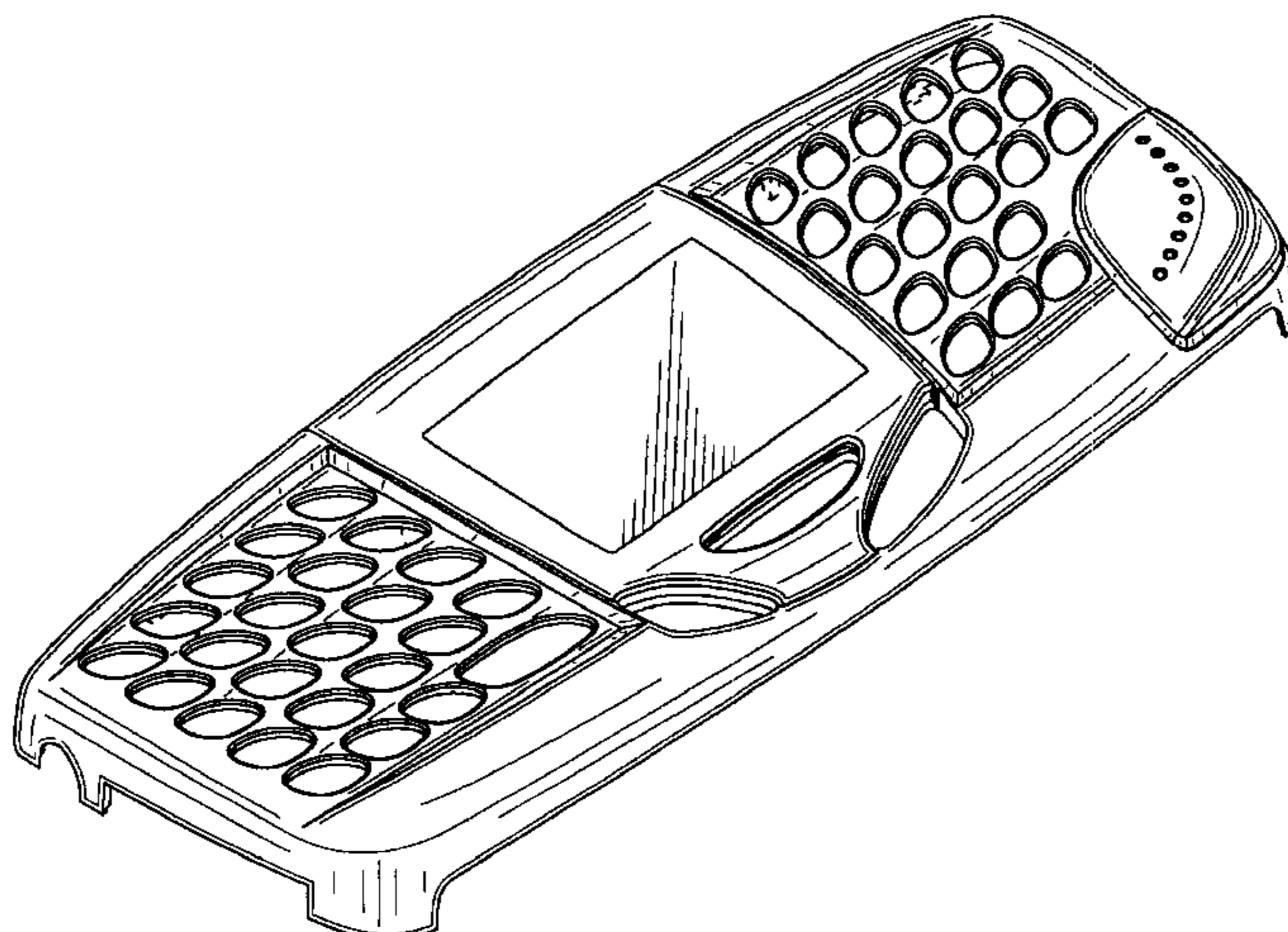

US D482,353 S

Page 2

U.S. PATENT DOCUMENTS

D414,522 S	*	9/1999	Kitamori	D21/329	6,301,100 B1	*	10/2001	Iwata	361/683
D416,253 S		11/1999	Hibino			D450,688 S	*	11/2001	Gartrell et al.	D14/247
D416,255 S		11/1999	Johansson et al.			6,317,313 B1	*	11/2001	Mosgrove et al.	361/680
D416,256 S		11/1999	Griffin et al.			D451,497 S	*	12/2001	Wang et al.	D14/218
D416,560 S	*	11/1999	Tonino	D14/218	D451,913 S		12/2001	Vuolteenaho et al.		
D416,910 S	*	11/1999	Vasquez	D14/218	D452,280 S	*	12/2001	Ota et al.	D21/329
D417,657 S		12/1999	Matsumoto			D453,149 S	*	1/2002	Skoger et al.	D14/138
D417,670 S	*	12/1999	Capps et al.	D14/218	D453,536 S	*	2/2002	Ota et al.	D21/329
6,016,423 A	*	1/2000	Ross et al.	455/90	D453,930 S		2/2002	Vuolteenaho et al.		
D419,983 S	*	2/2000	Foslien et al.	D14/441	D454,348 S		3/2002	Yeh		
D420,680 S	*	2/2000	Curtis	D14/248	D454,349 S		3/2002	Makidera et al.		
D421,022 S	*	2/2000	Curtis	D14/248	D454,549 S		3/2002	Vuolteenaho et al.		
D422,282 S		4/2000	Curtis			D454,868 S		3/2002	Vuolteenaho et al.		
D422,972 S		4/2000	King			D454,869 S		3/2002	Becker et al.		
D423,508 S	*	4/2000	Nakajima	D14/218	D457,565 S	*	5/2002	Catlin	D19/60
6,047,196 A		4/2000	Makela et al.			D459,717 S	*	7/2002	Bohne	D14/218
D426,218 S		6/2000	Abed et al.			D464,995 S	*	10/2002	Griffin et al.	D21/329
D427,171 S		6/2000	Frye et al.			D467,913 S	*	12/2002	Lai et al.	D14/248
D428,448 S	*	7/2000	Kitamori	D21/329	D467,917 S	*	12/2002	Tischer	D14/345
6,147,858 A	*	11/2000	Takahashi	361/680	D469,749 S	*	2/2003	Kim	D14/138
D437,847 S	*	2/2001	Moser, Jr. et al.	D14/346	D470,135 S	*	2/2003	Buesseler et al.	D14/248
D438,854 S		3/2001	Badoual			D472,551 S	*	4/2003	Griffin	D14/346
D439,898 S		4/2001	Ober et al.			2003/0006968 A1	*	1/2003	Solomon	345/168
D440,959 S		4/2001	Wolf et al.			2003/0044000 A1	*	3/2003	Kfoury et al.	379/433.04
D446,526 S	*	8/2001	Evers et al.	D14/441	2003/0078069 A1	*	4/2003	Lindeman	455/550
D447,740 S		9/2001	Johansson								

* cited by examiner

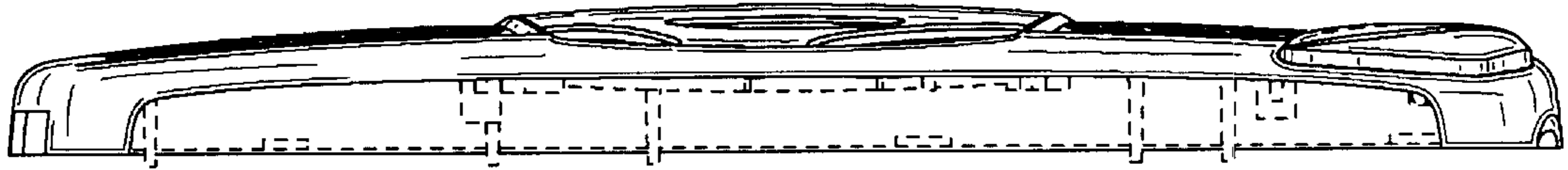

FIG. 1

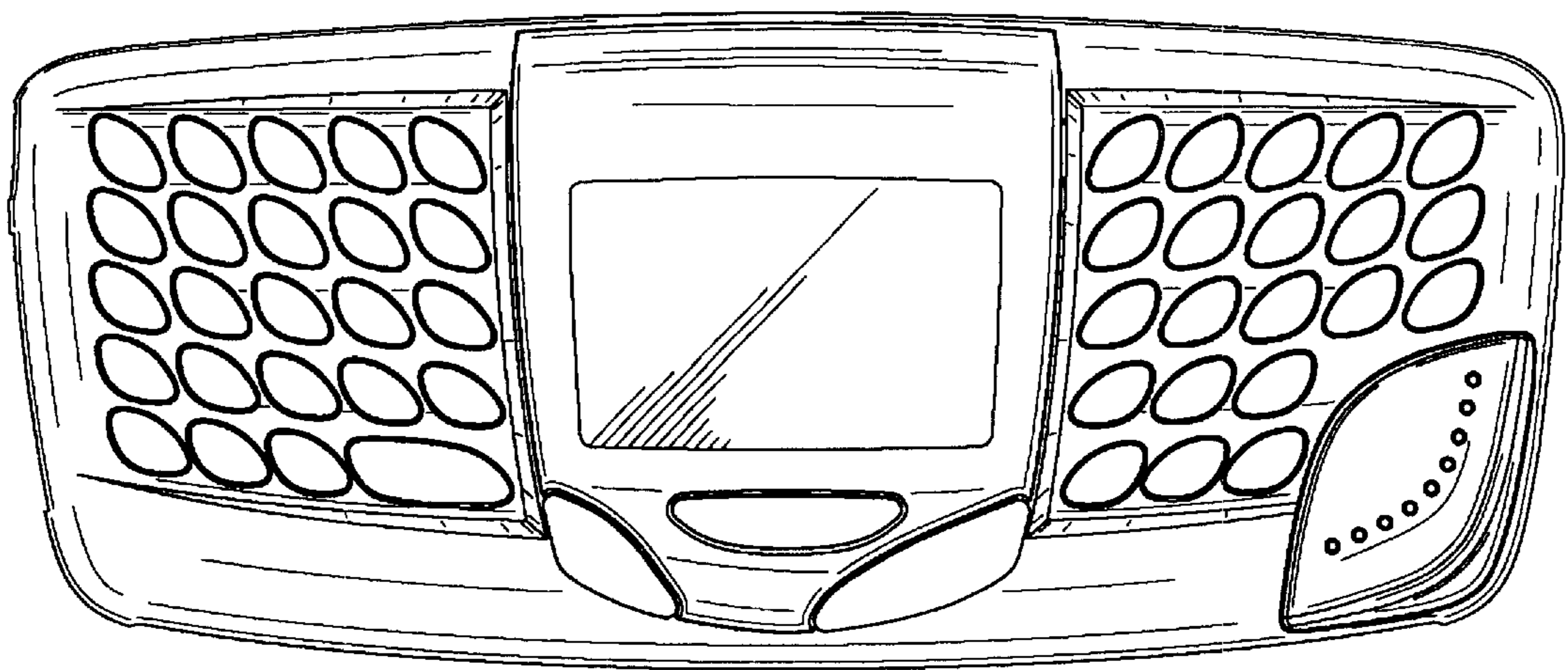

FIG. 2

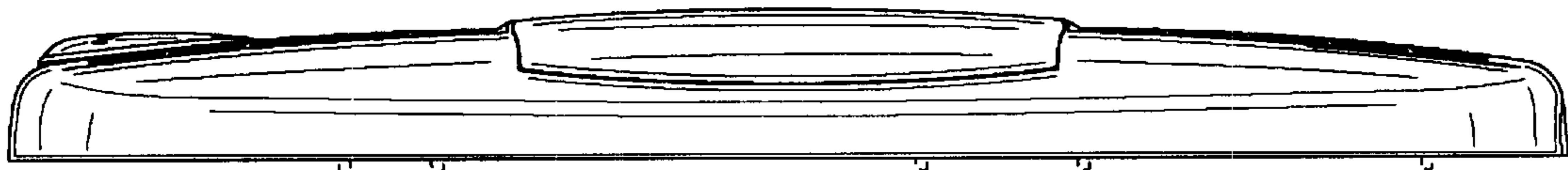

FIG. 3

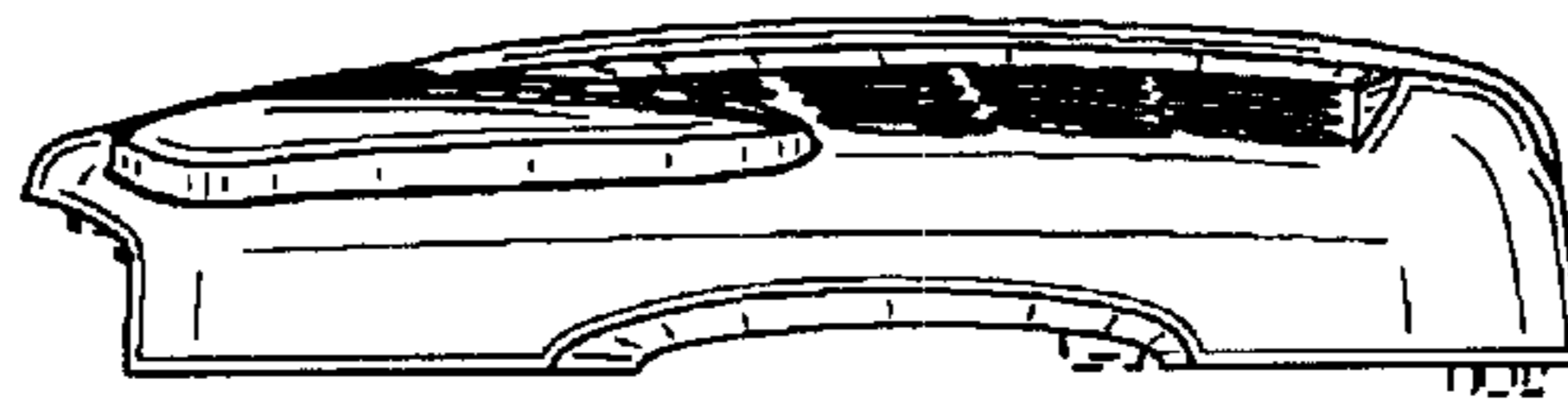

FIG. 4

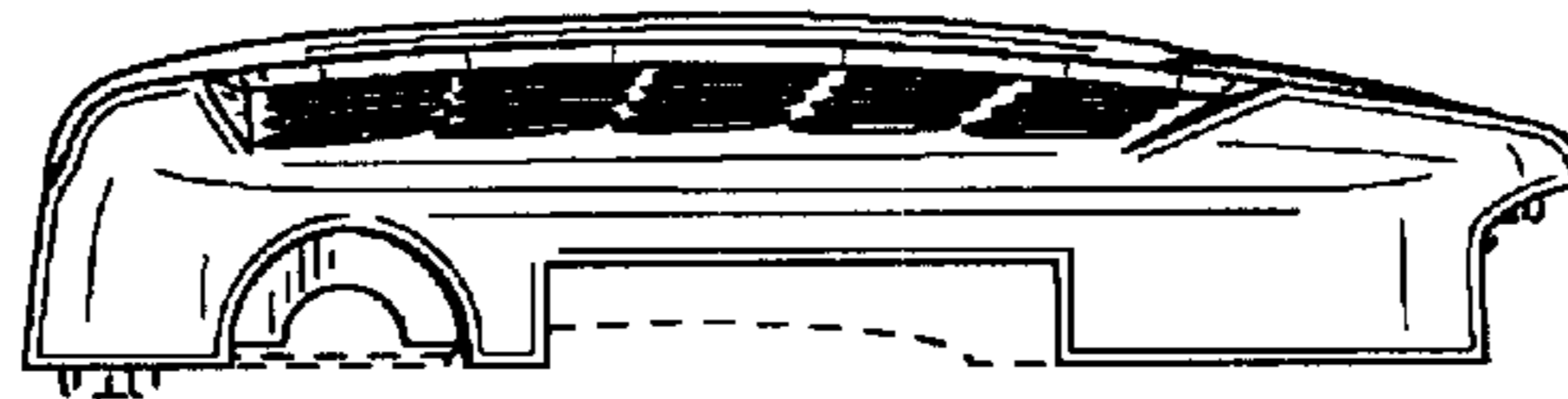

FIG. 5

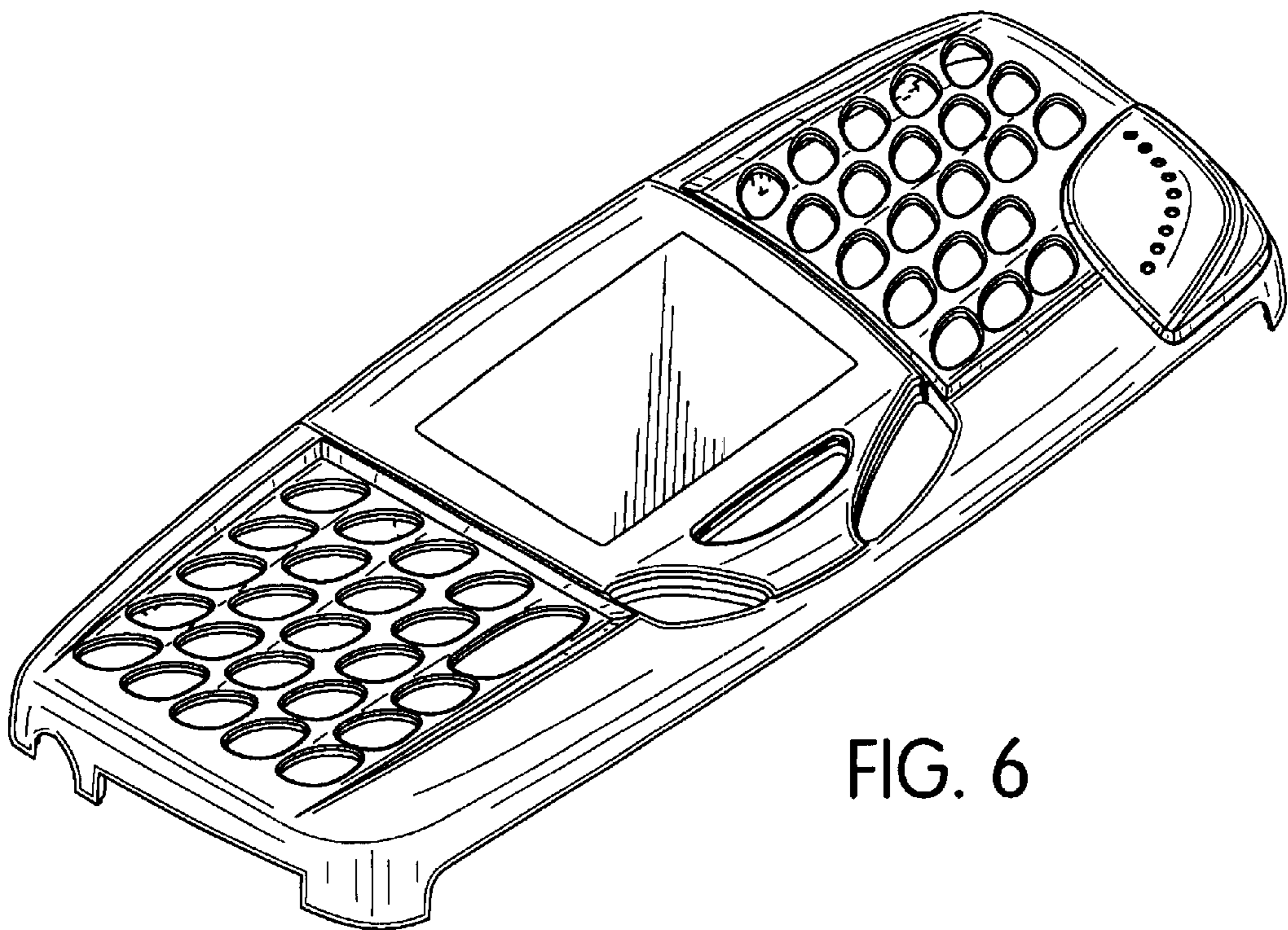

FIG. 6