



US00D482292S

(12) **United States Design Patent**
Minshall et al.

(10) **Patent No.:** **US D482,292 S**

(45) **Date of Patent:** **** Nov. 18, 2003**

(54) **TEMPERATURE GAUGE**

6,490,776 B1 * 12/2002 Gager et al. 180/90

(75) Inventors: **Patrick Minshall**, Caledon (CA);
Stuart T. McKenzie, Wyevale (CA)

* cited by examiner

(73) Assignee: **Fiesta Barbeques Limited** (CA)

Primary Examiner—Antoine Duval Davis

(74) *Attorney, Agent, or Firm*—Larson & Taylor, PLC

(**) Term: **14 Years**

(57) **CLAIM**

(21) Appl. No.: **29/169,813**

The ornamental design of a temperature gauge, as shown and described.

(22) Filed: **Oct. 28, 2002**

DESCRIPTION

(30) **Foreign Application Priority Data**

Oct. 24, 2002 (CA) 101024

(51) **LOC (7) Cl.** **10-04**

(52) **U.S. Cl.** **D10/102**

(58) **Field of Search** D10/57, 102; D12/192;
180/90; 362/23-30, 253, 254, 307, 489

FIG. 1 is a front view of the temperature gauge;
FIG. 2 is a bottom view of the temperature gauge of FIG. 1;
FIG. 3 is a rear view of the temperature gauge of FIG. 1;
FIG. 4 is a left-hand side view of the temperature gauge of FIG. 1;
FIG. 5 is a right-hand side view of the temperature gauge of FIG. 1; and,
FIG. 6 is a top view of the temperature gauge of FIG. 1.
The broken line showing is for illustrative purposes only and forms no part of the claimed design.

(56) **References Cited**

U.S. PATENT DOCUMENTS

D440,503 S * 4/2001 Gordon et al. D10/57

1 Claim, 6 Drawing Sheets

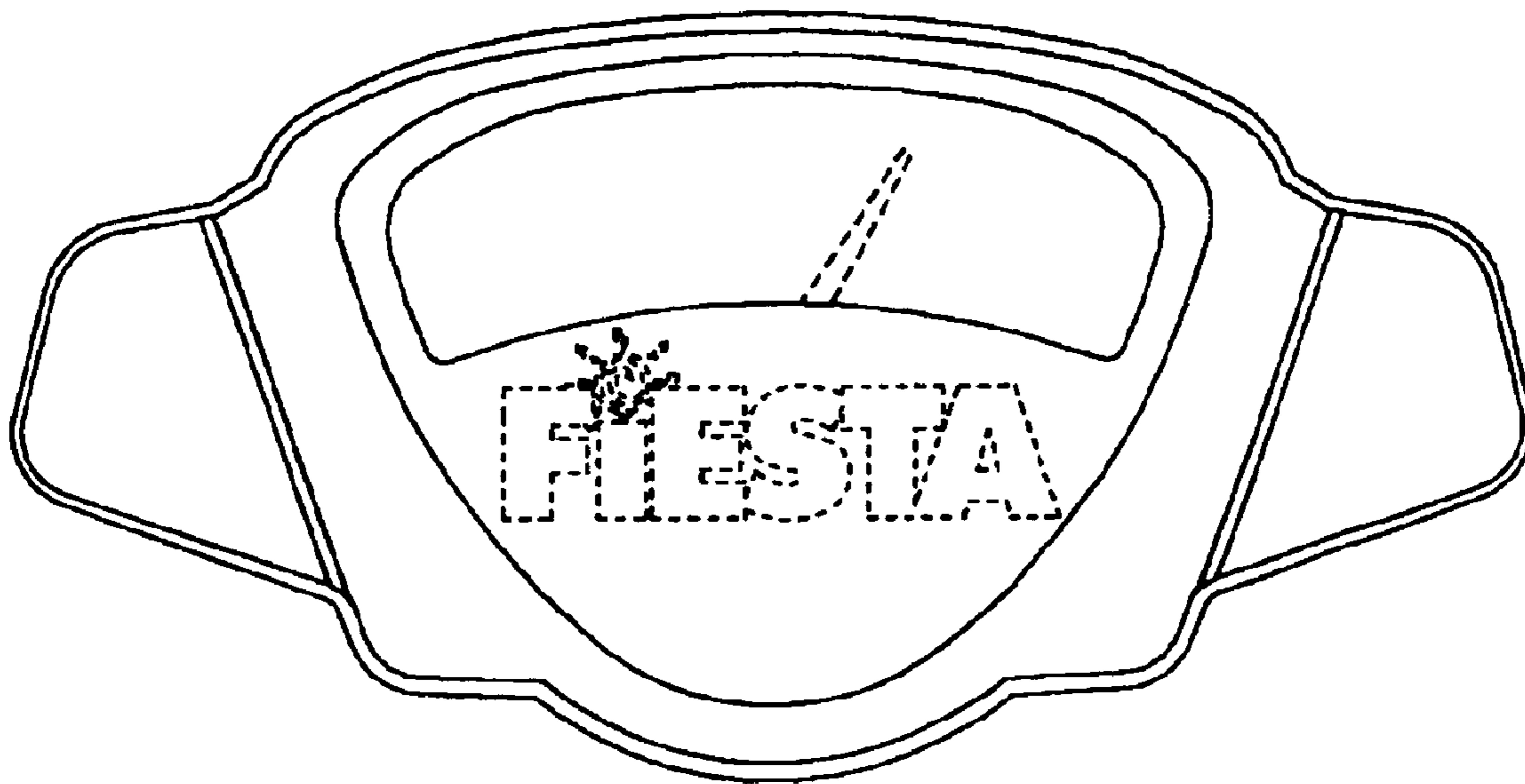

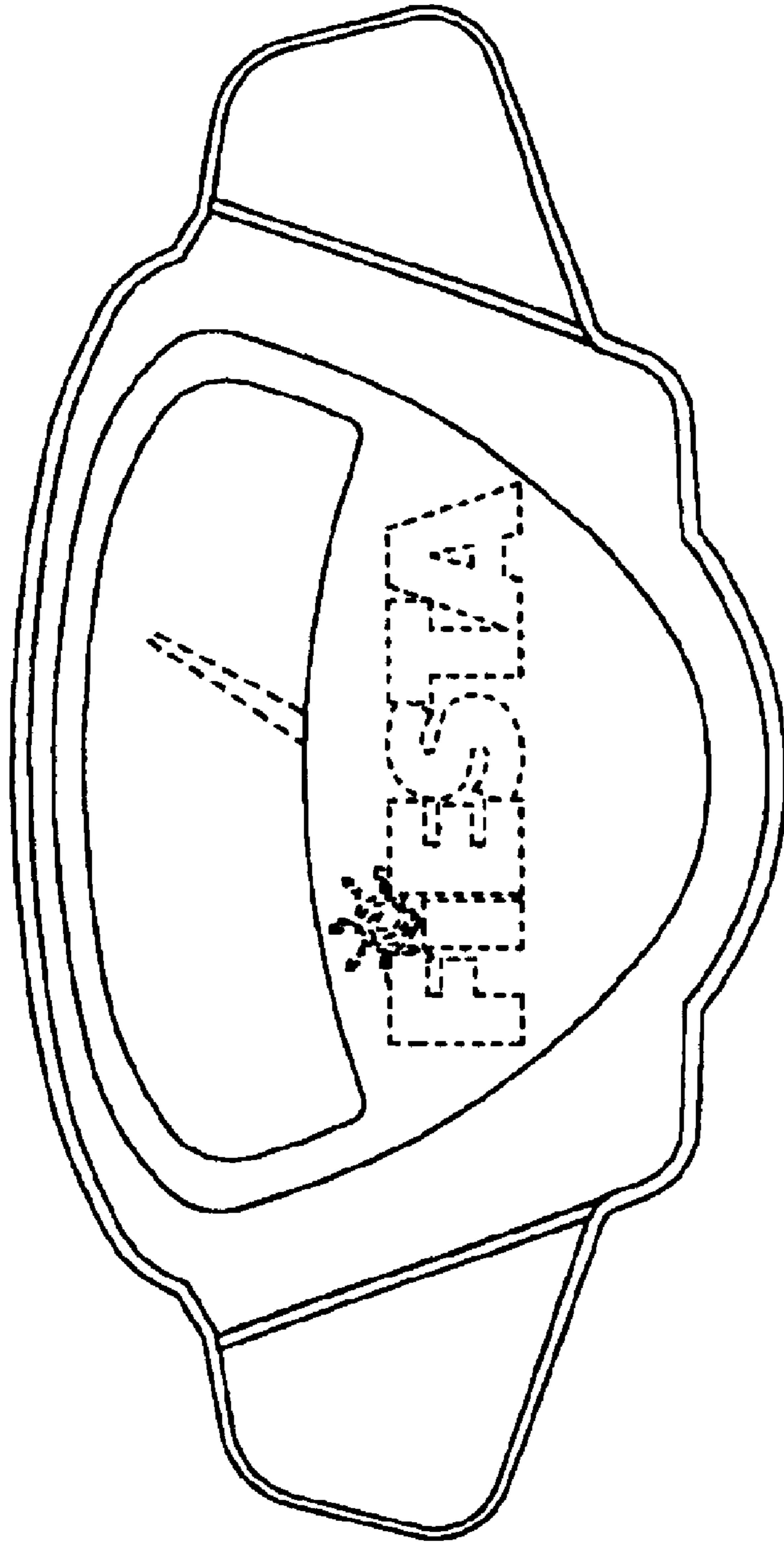

FIG. 1

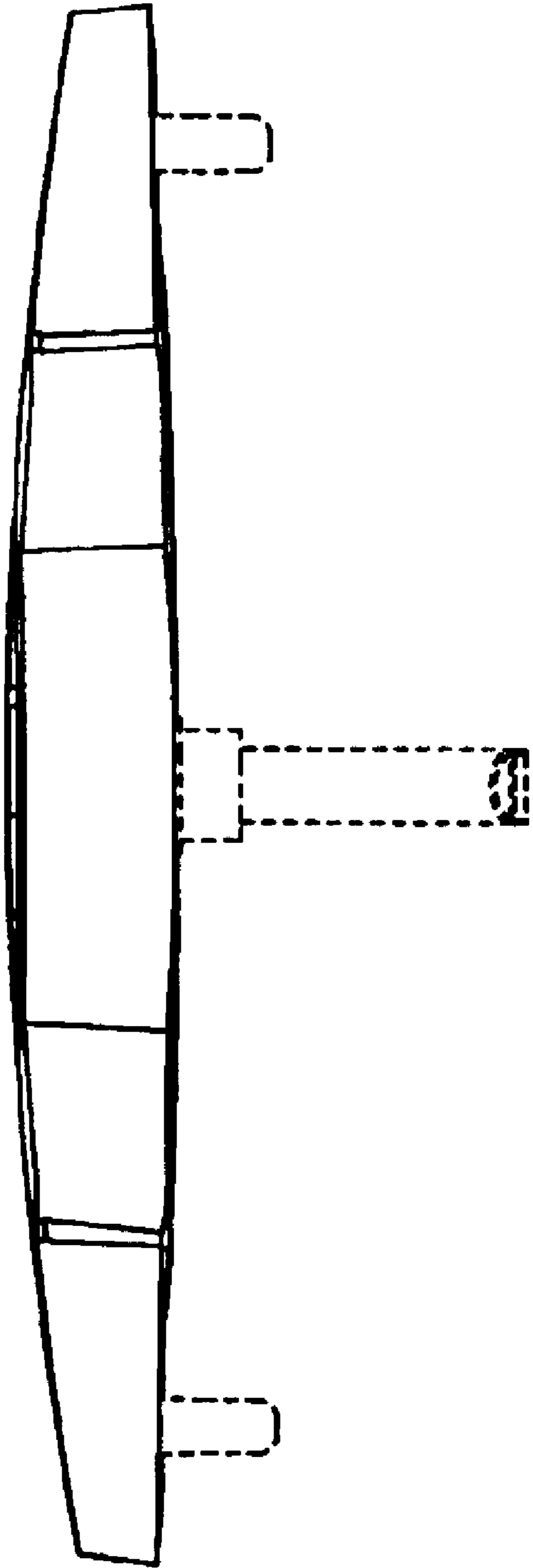

Fig. 2

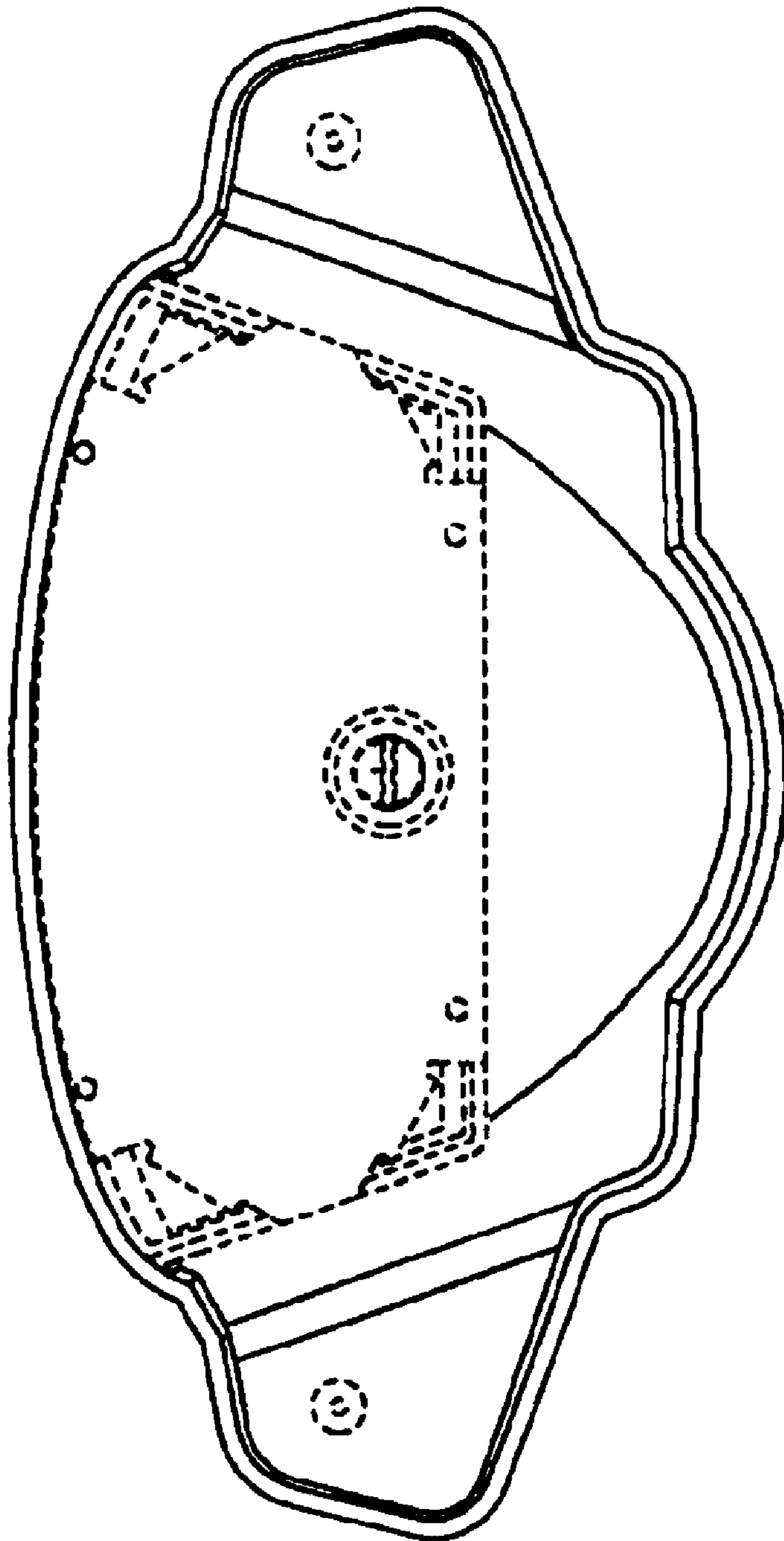

FIG. 2

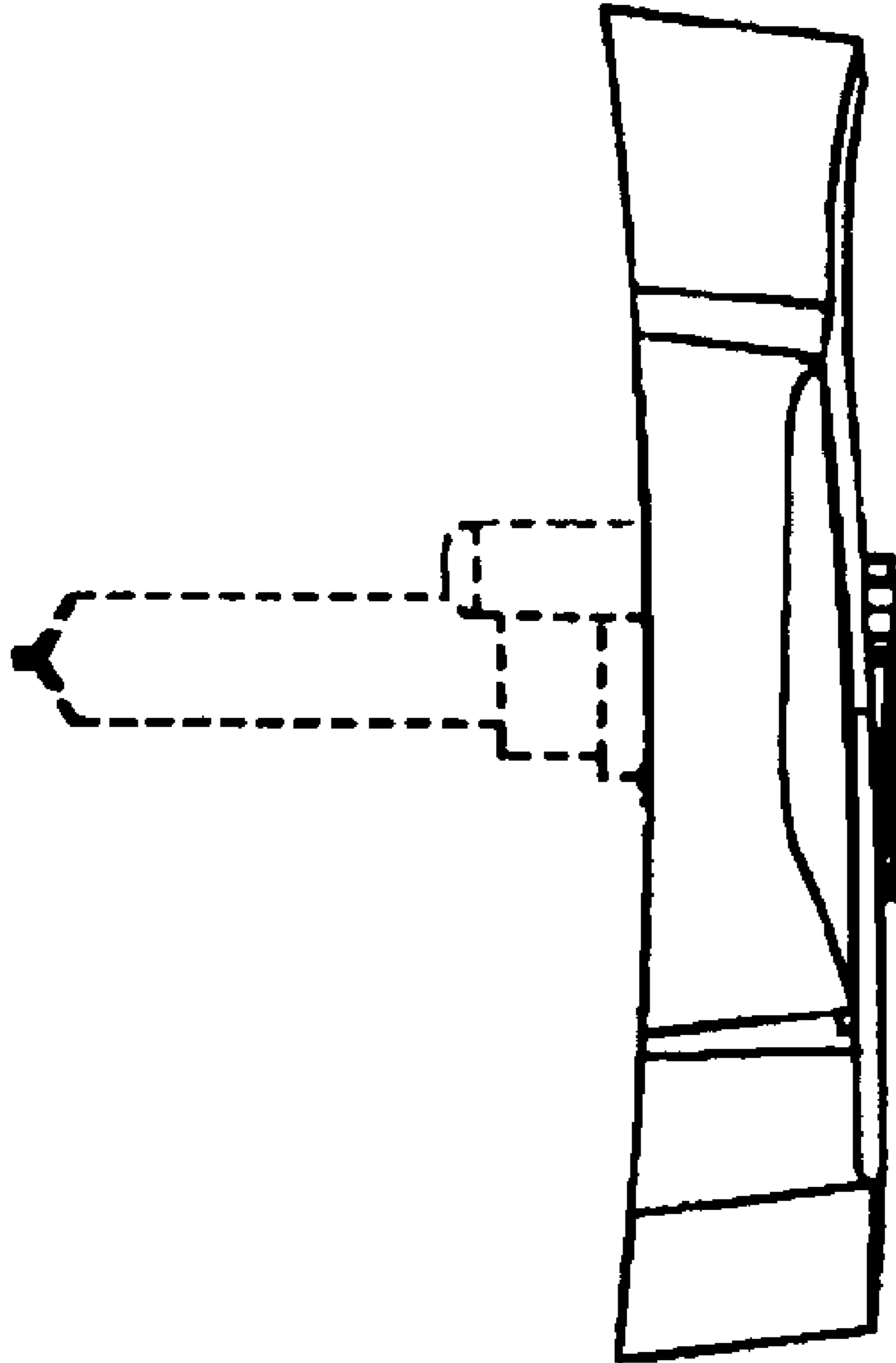

FIG. 4

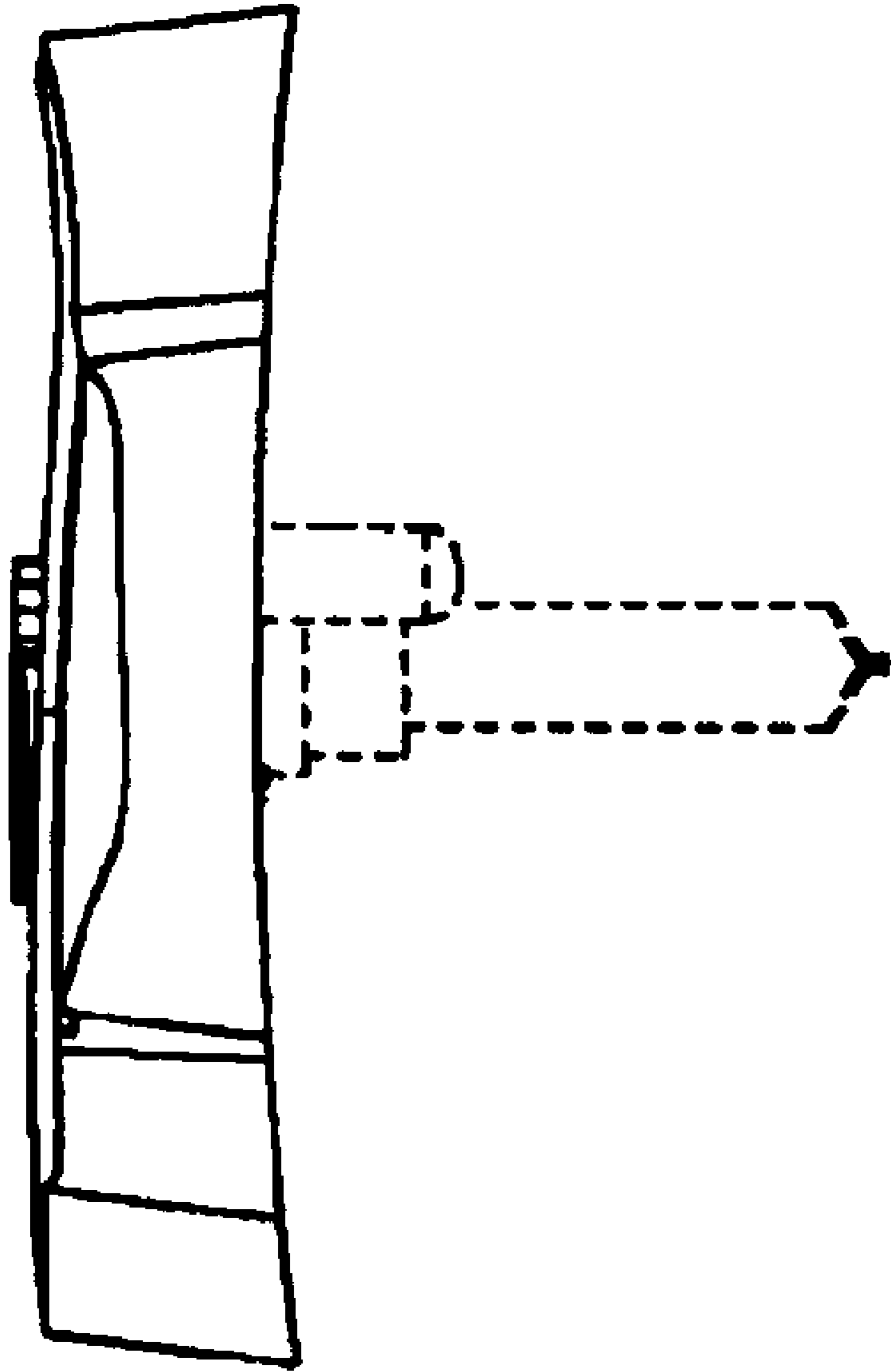

FIG. 5

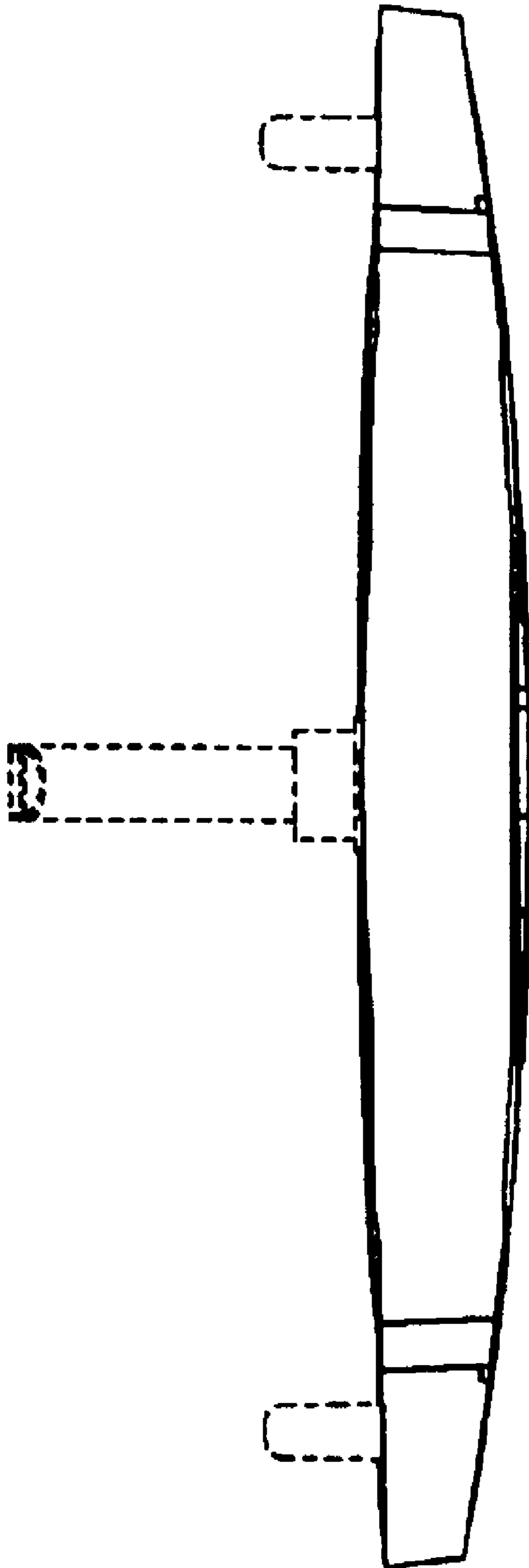

FIG. 6