



US00D482285S

(12) **United States Design Patent**  
**Desouza**

(10) **Patent No.:** **US D482,285 S**

(45) **Date of Patent:** **\*\* Nov. 18, 2003**

(54) **BOTTLE**

(75) **Inventor:** **Eric Desouza, Concord (CA)**

(73) **Assignee:** **S. C. Johnson & Son, Inc., Racine, WI (US)**

(\*\*) **Term:** **14 Years**

(21) **Appl. No.:** **29/167,505**

(22) **Filed:** **Sep. 17, 2002**

(51) **LOC (7) Cl.** ..... **09-01**

(52) **U.S. Cl.** ..... **D9/522; D9/520; D9/575; D9/526**

(58) **Field of Search** ..... **D9/516, 522, 523, D9/526, 527, 528, 530, 543, 551, 557, 564, 570, 575; 215/382-384, 396, 398, 400, 11.1-11.6**

(56) **References Cited**

**U.S. PATENT DOCUMENTS**

357,439	A	*	2/1887	Wheelock	.....	215/11.5
D156,676	S	*	12/1949	Skidmore	.....	D9/300
D158,800	S	*	5/1950	Robb	.....	D9/526
D166,454	S	*	4/1952	Cardoso	.....	D9/523
D214,331	S	*	6/1969	Greaney	.....	D7/507
D246,226	S		11/1977	Avolio		
4,087,028	A	*	5/1978	Lang	.....	222/556
D258,046	S	*	1/1981	Richmond	.....	D9/529
D280,601	S	*	9/1985	Biesecker	.....	D9/522
D304,550	S	*	11/1989	Demarest	.....	D9/529
D319,972	S		9/1991	Segati et al.		
D325,520	S	*	4/1992	Biesecker	.....	D9/526
D326,610	S	*	6/1992	Kritzler	.....	D9/526
D327,010	S	*	6/1992	Spiegel	.....	D9/528

D336,607	S	*	6/1993	Nye	.....	D9/300
D381,270	S	*	7/1997	Ballarin et al.	.....	D9/526
D382,205	S		8/1997	Goettner et al.		
D392,568	S	*	3/1998	Goettner	.....	D9/526
D402,561	S	*	12/1998	Utrup et al.	.....	D9/526
D414,115	S	*	9/1999	Goettner et al.	.....	D9/526
D427,078	S		6/2000	Schaaf et al.		
D429,648	S	*	8/2000	Goettner	.....	D9/543 X
D439,518	S		3/2001	Gavin		

**OTHER PUBLICATIONS**

“The Keepsake Gifts of Christmas”, Lord & Taylor booklet, printed by Lord & Taylor, NY., © 1992, p. 13.\*

\* cited by examiner

*Primary Examiner*—Ted Shooman  
*Assistant Examiner*—Carol Rademaker

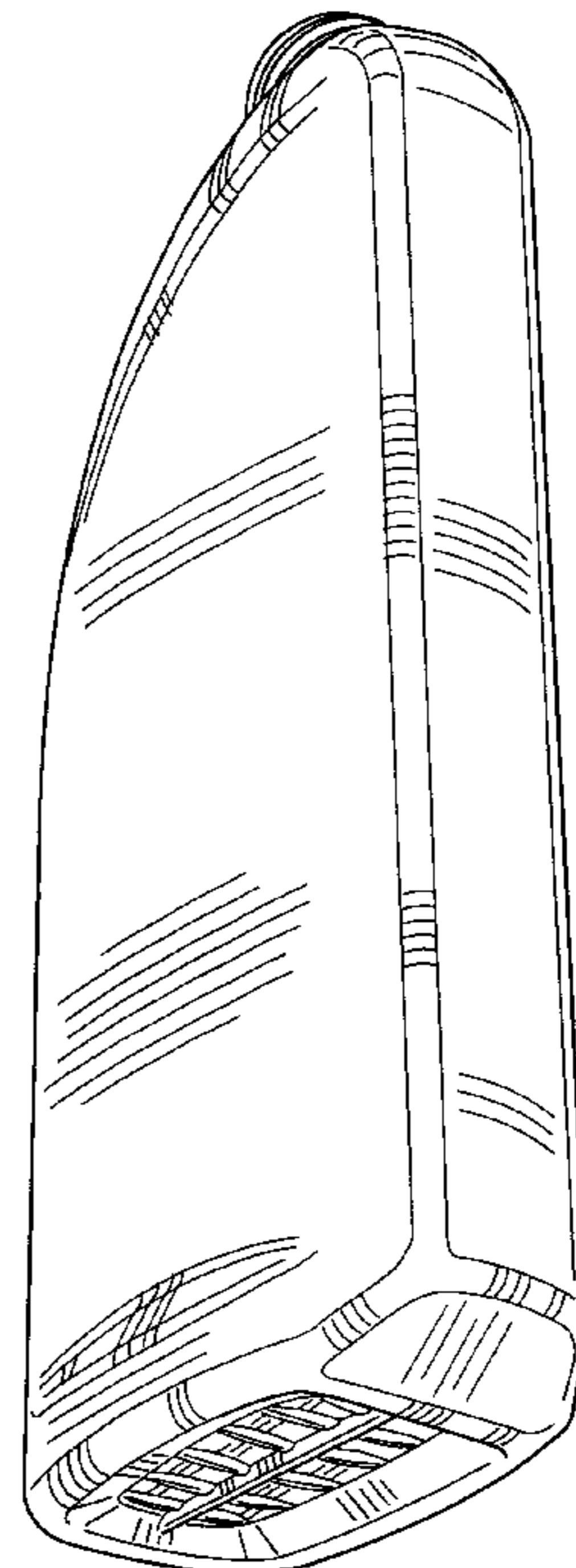
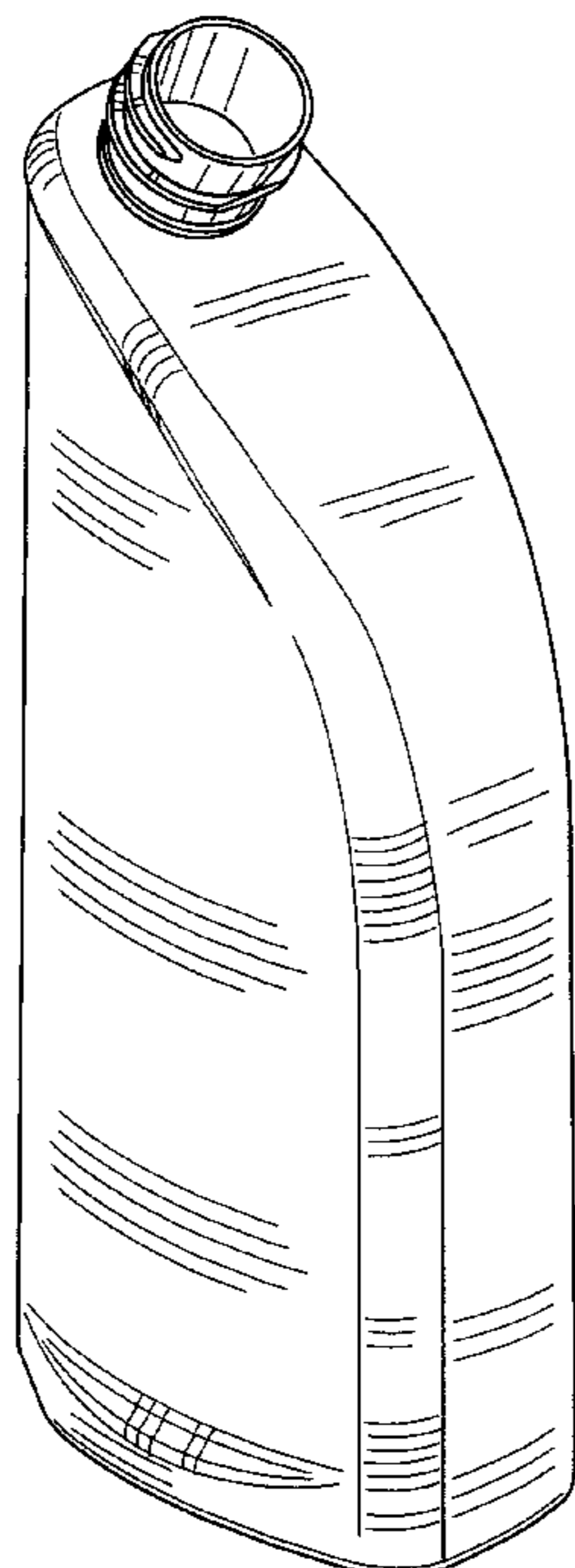
(57) **CLAIM**

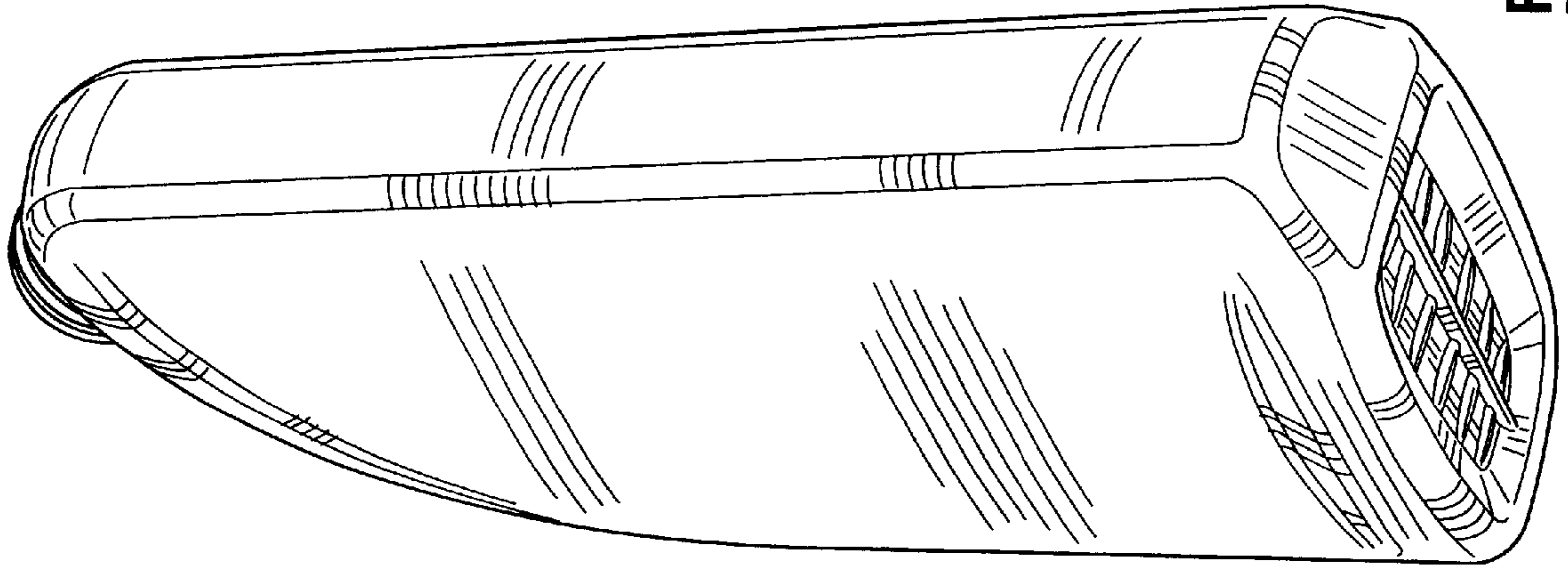
I claim the ornamental design for a bottle, as shown and described.

**DESCRIPTION**

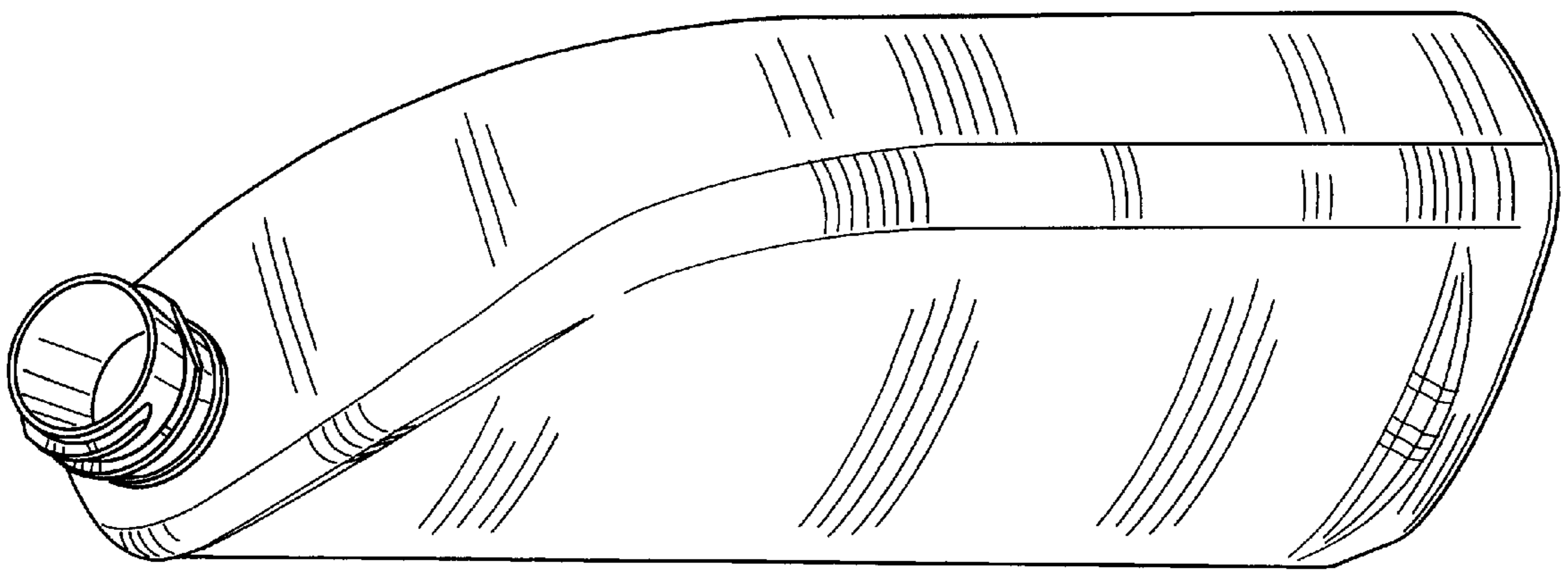
FIG. 1 is a perspective view of a bottle from the front, top and left side thereof showing my new design;  
FIG. 2 is a perspective view of the bottle from the rear, bottom, and right side thereof;  
FIG. 3 is a left side view thereof;  
FIG. 4 is a right side view thereof;  
FIG. 5 is a front view thereof;  
FIG. 6 is a rear view thereof;  
FIG. 7 is a top view thereof; and,  
FIG. 8 is a bottom view thereof.

**1 Claim, 3 Drawing Sheets**

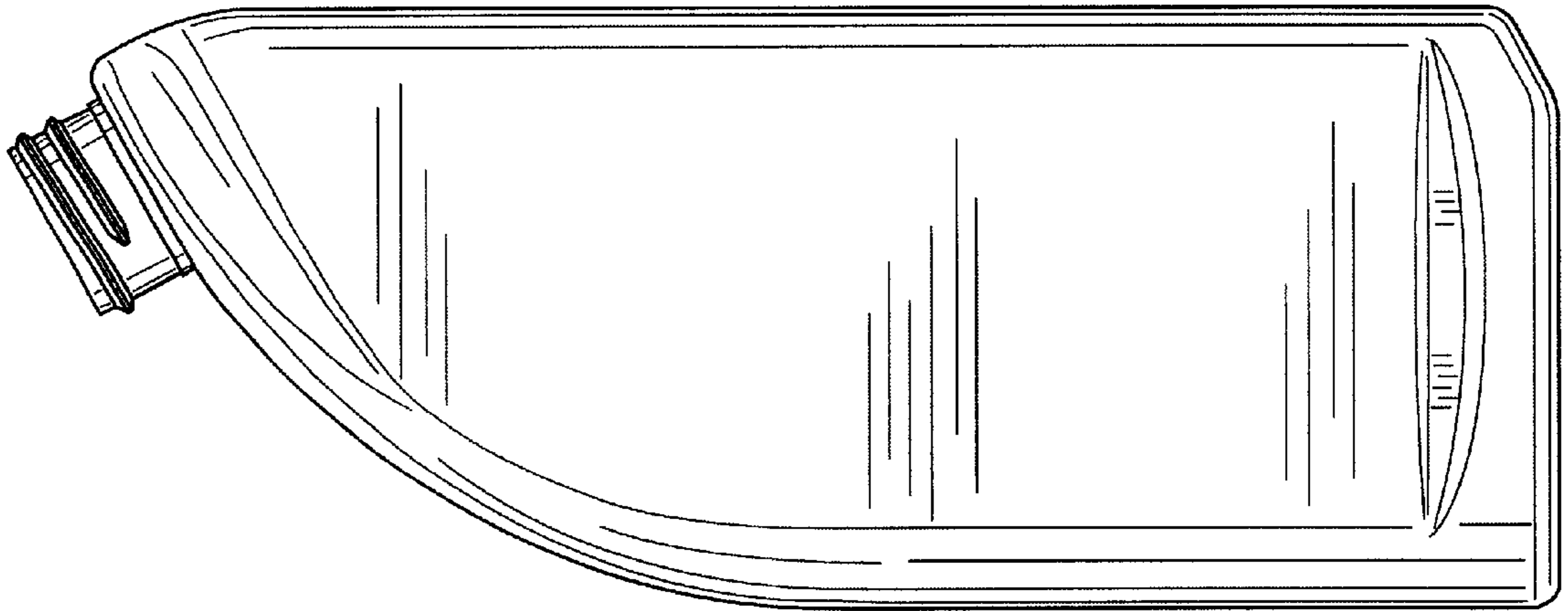




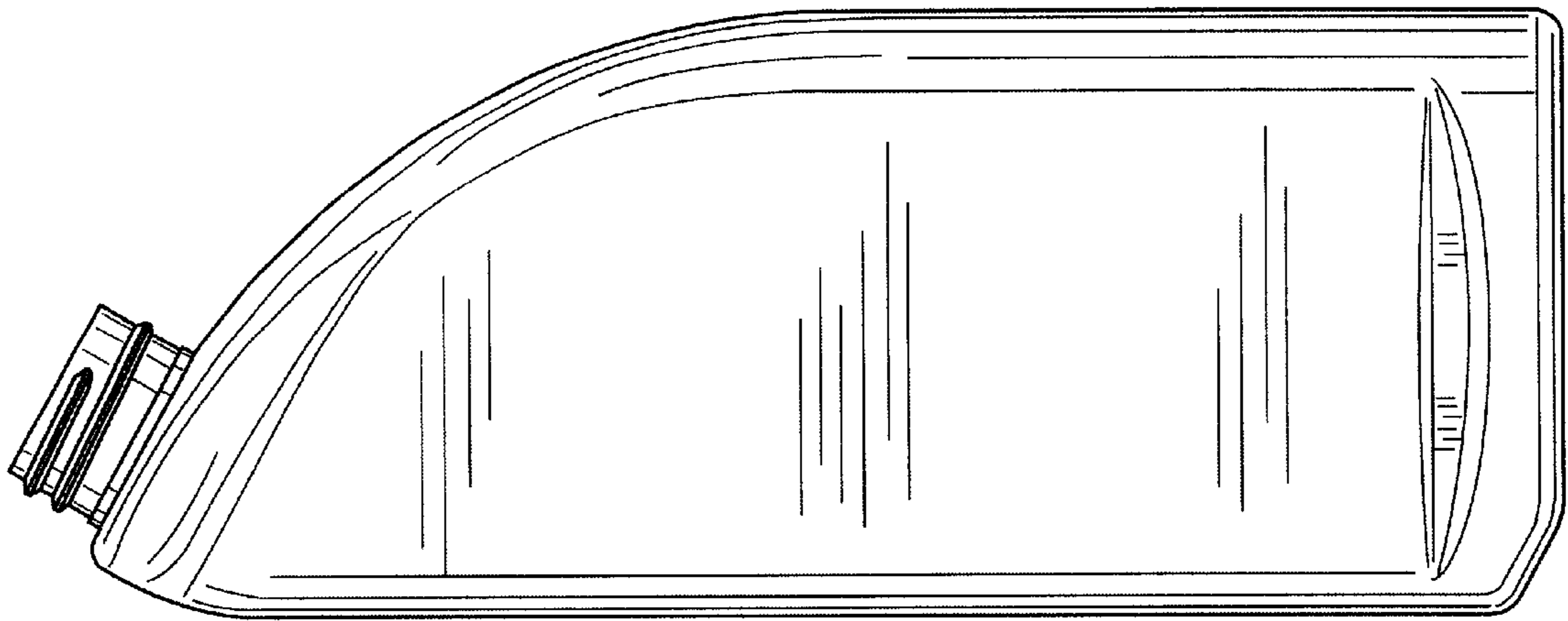
**FIG. 2**



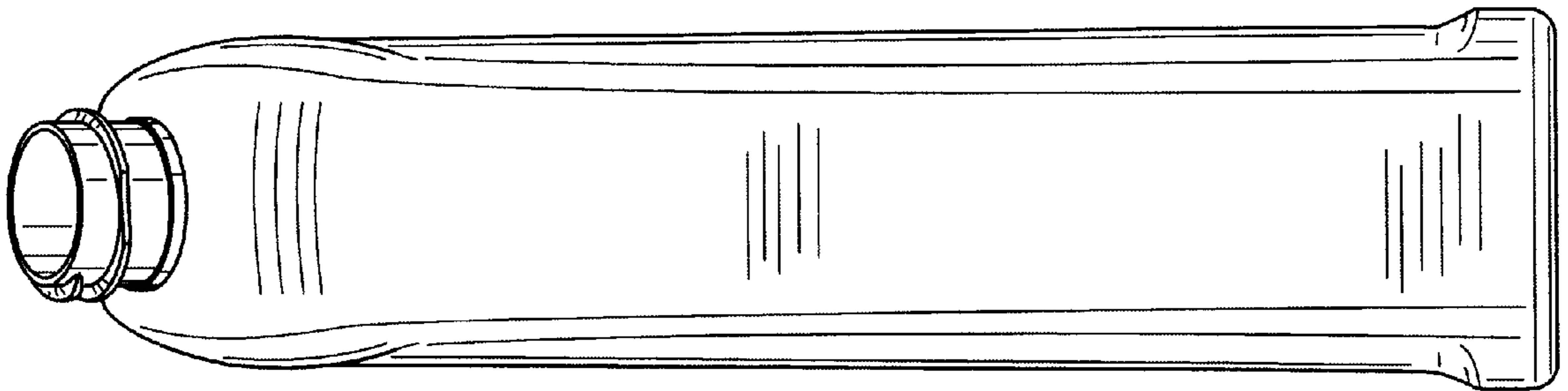
**FIG. 1**



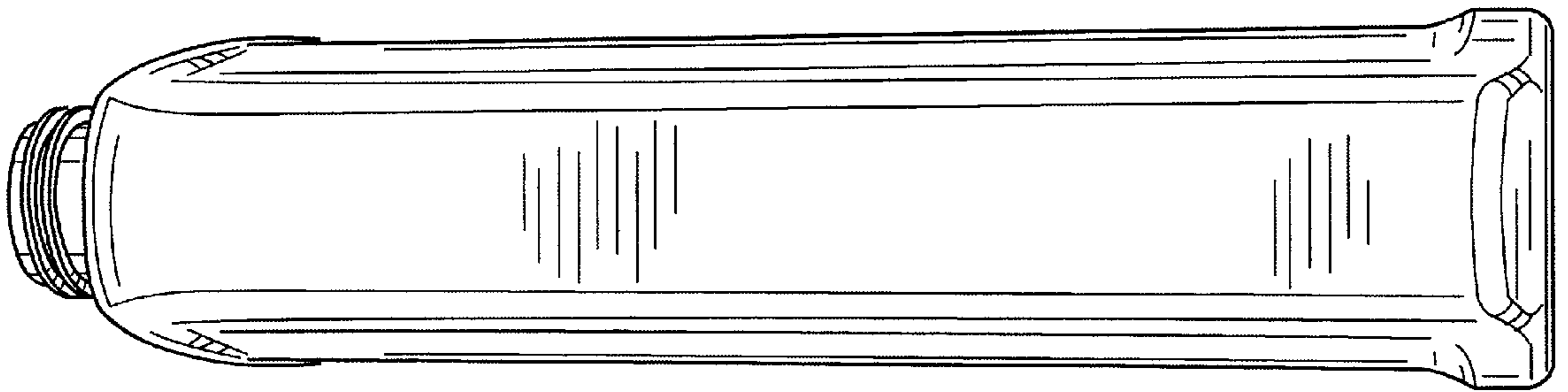
**FIG. 4**



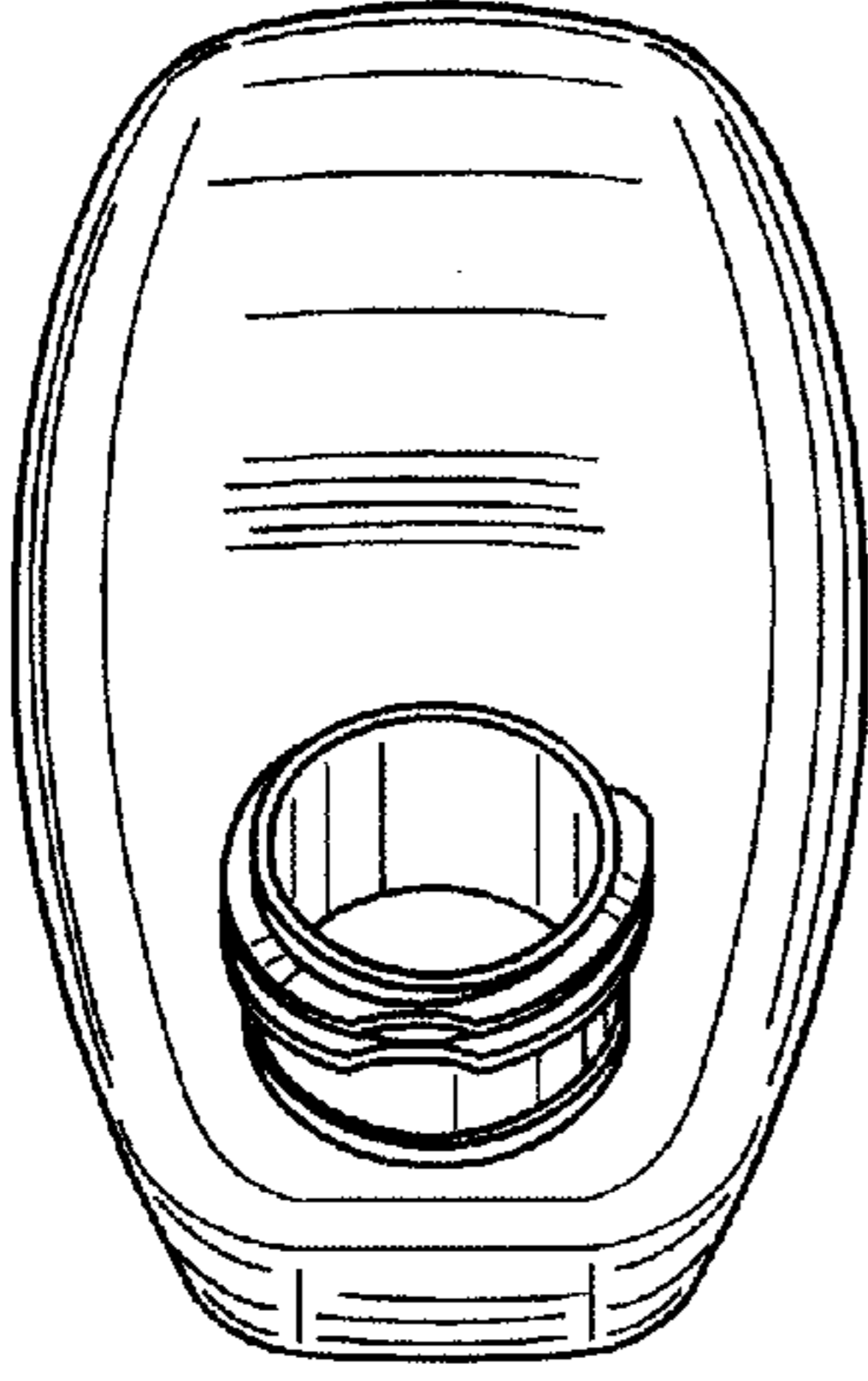
**FIG. 3**



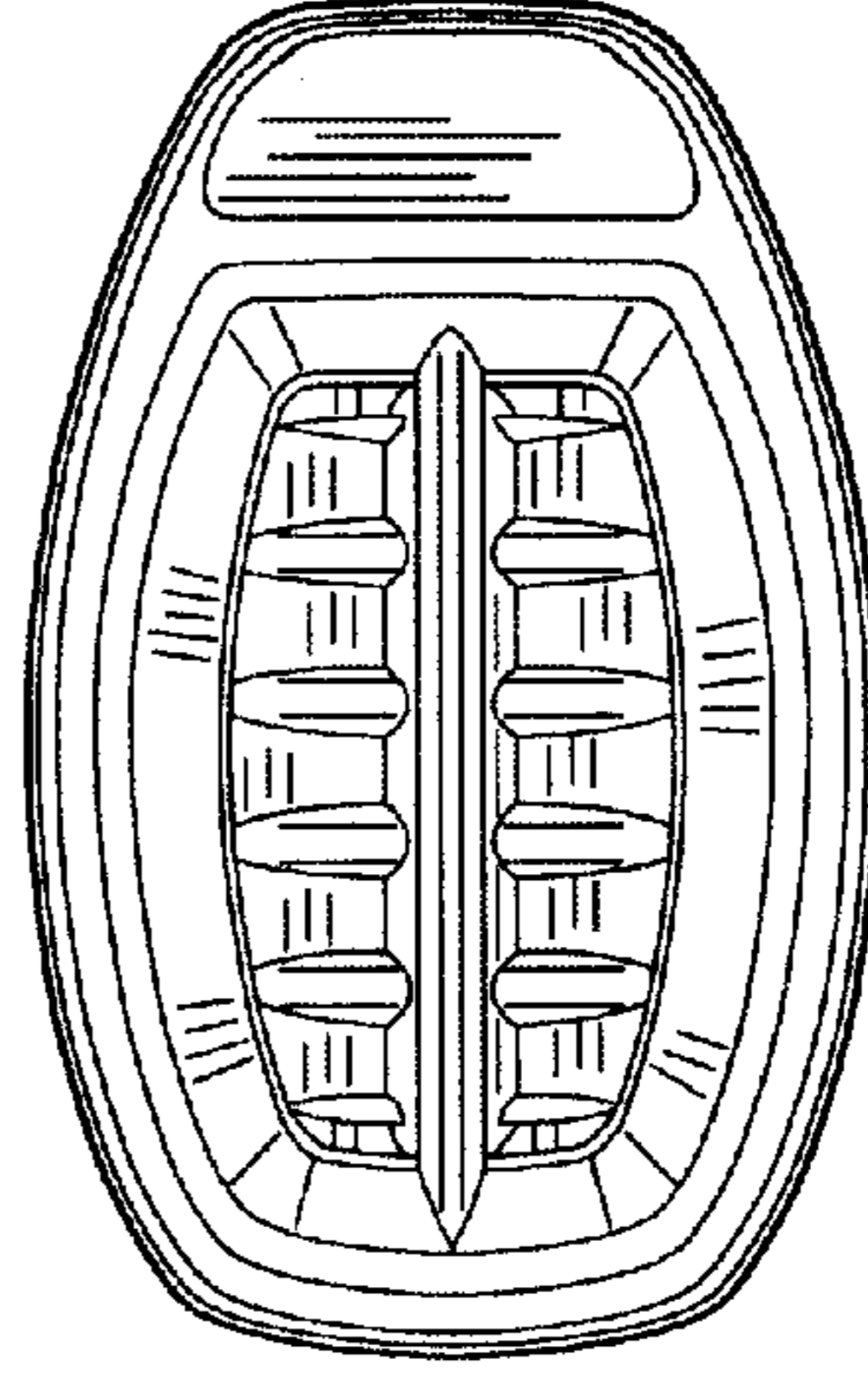
**FIG. 5**



**FIG. 6**



**FIG. 7**



**FIG. 8**