



US00D482237S

(12) **United States Design Patent**
Wellner

(10) **Patent No.:** **US D482,237 S**

(45) **Date of Patent:** **** Nov. 18, 2003**

(54) **CUP**
(75) **Inventor:** **Lucie L. Wellner**, Pompey, NY (US)
(73) **Assignee:** **Syracuse China Company**, Syracuse, NY (US)
(**) **Term:** **14 Years**

D356,925 S * 4/1995 Wonder D7/536
D434,603 S * 12/2000 Benson D7/536
D455,047 S * 4/2002 Wolfe et al. D7/514
D463,216 S * 9/2002 McDonough et al. D7/509
D463,954 S * 10/2002 Wellner D7/536
D465,132 S * 11/2002 Janky et al. D7/510
D467,124 S * 12/2002 Janky D7/533
D473,105 S * 4/2003 Ayers et al. D7/536

* cited by examiner

(21) **Appl. No.:** **29/156,685**
(22) **Filed:** **Mar. 7, 2002**
(51) **LOC (7) Cl.** **07-01**
(52) **U.S. Cl.** **D7/509; D7/514; D7/536**
(58) **Field of Search** **D7/536, 533, 514,**
D7/509, 523; 220/630, 756; 215/371, 398,
13.1

Primary Examiner—M. N. Pandozzi
(74) *Attorney, Agent, or Firm*—Emch, Schaffer, Schaub & Porcello Co., L.P.A.

(57) **CLAIM**

The ornamental design for a cup, as shown and described.

DESCRIPTION

FIG. 1 is a front elevational view of a first embodiment cup according to the present design; the back elevational view being a mirror image thereof;
FIG. 2 is a first side elevational view thereof;
FIG. 3 is a second side elevational view thereof;
FIG. 4 is a top view thereof;
FIG. 5 is a bottom view thereof;
FIG. 6 is a front elevational view of a second embodiment cup according to the present design; the back elevational view being the same;
FIG. 7 is a first side elevational view thereof; the second side elevational view being the same;
FIG. 8 is a top view thereof; and,
FIG. 9 is a bottom view thereof.

(56) **References Cited**
U.S. PATENT DOCUMENTS
D100,850 S * 8/1936 Cowan D7/536
D184,518 S * 3/1959 Folley D7/536
D207,786 S * 5/1967 Benes D7/536
D227,532 S * 7/1973 Refsgaard D7/536
D230,457 S * 2/1974 Bateman D7/536
D270,507 S * 9/1983 Thrush D7/536
D286,966 S * 12/1986 Ritman D7/536
D290,324 S * 6/1987 Ritman D7/536
D290,325 S * 6/1987 Ritman D7/536
D313,921 S * 1/1991 Unger D7/509
D320,329 S * 10/1991 Unger D7/536
D320,907 S * 10/1991 Unger D7/536
D321,814 S * 11/1991 Unger D7/536
D353,518 S * 12/1994 Cautereels et al. D7/560

1 Claim, 5 Drawing Sheets

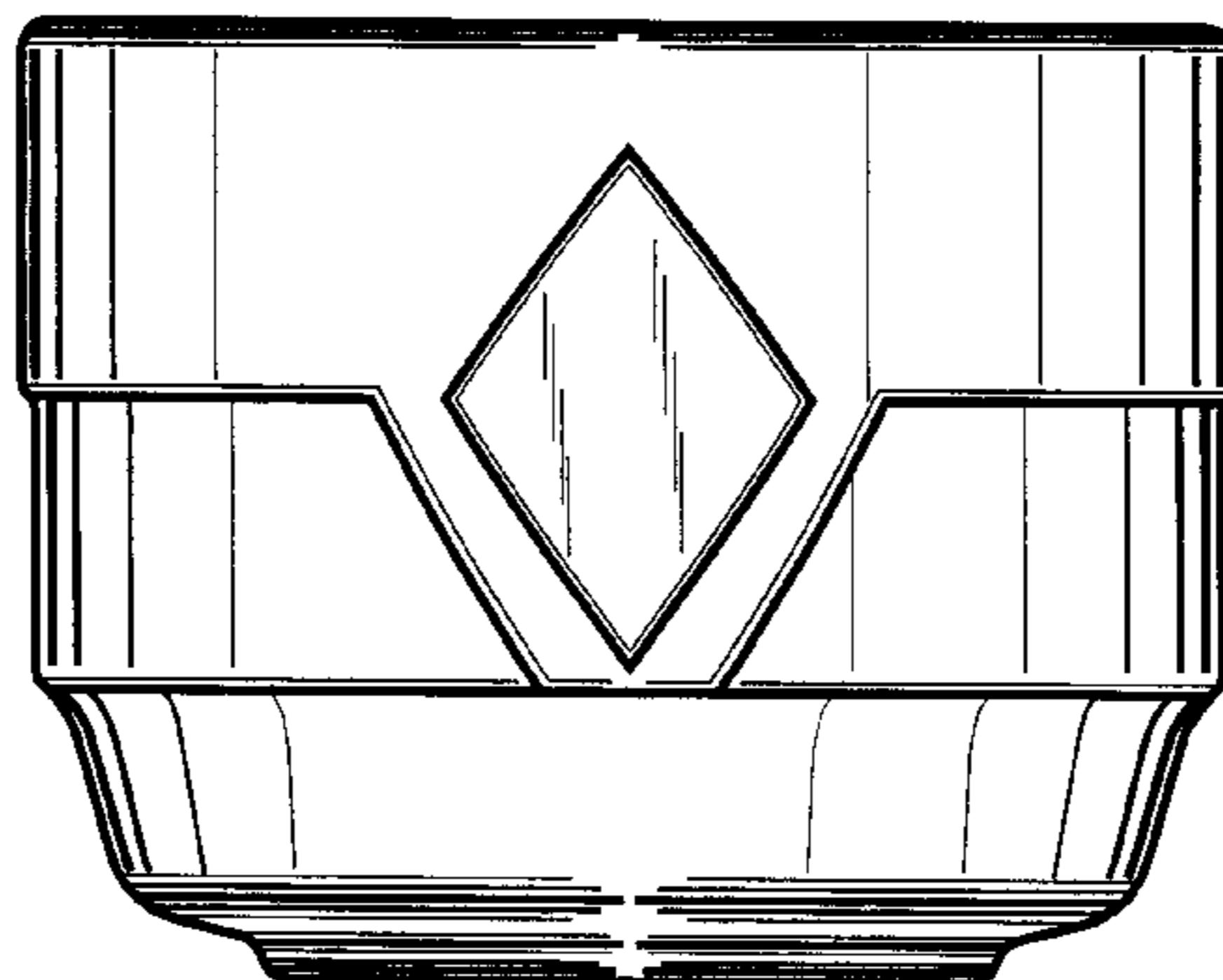
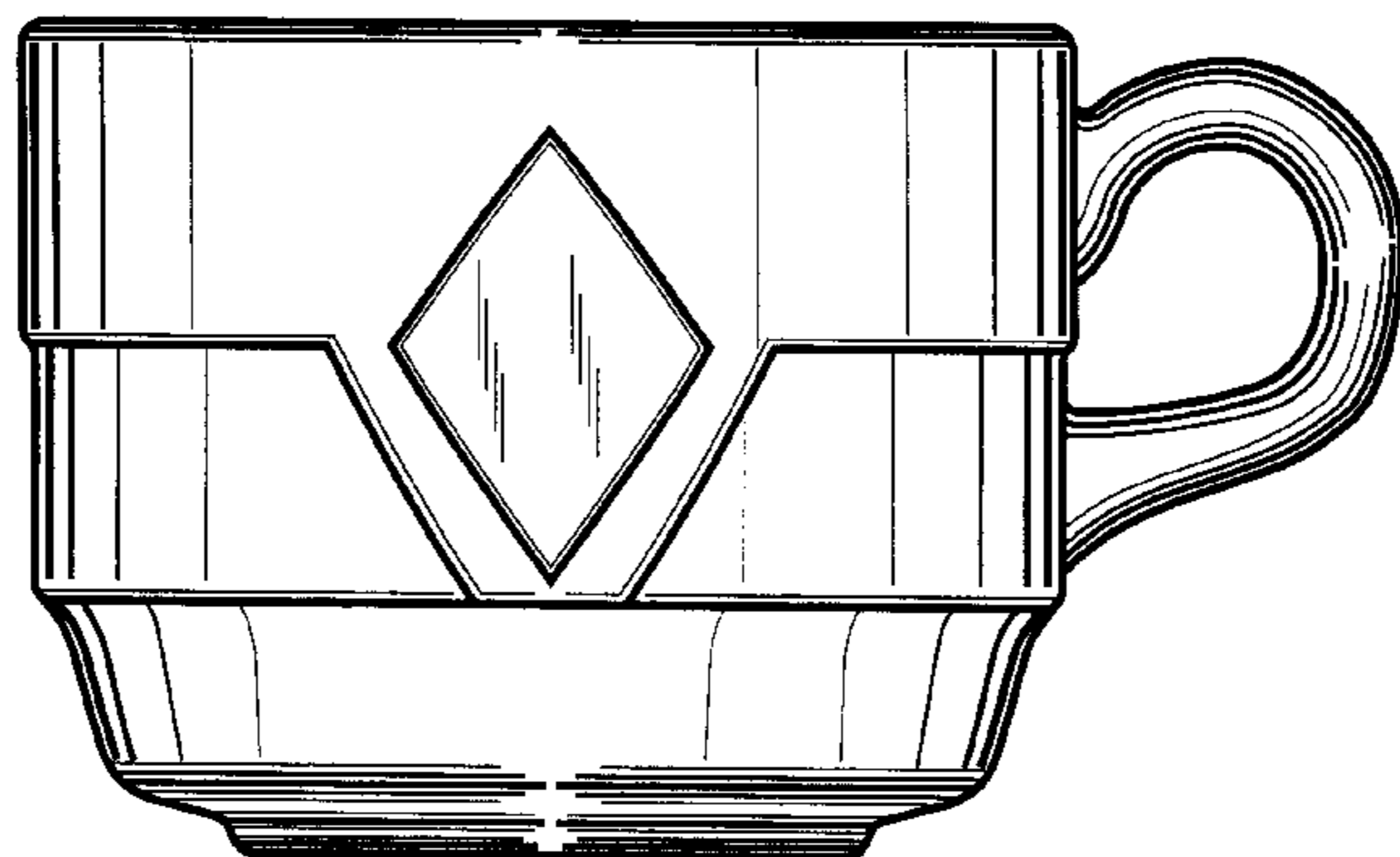

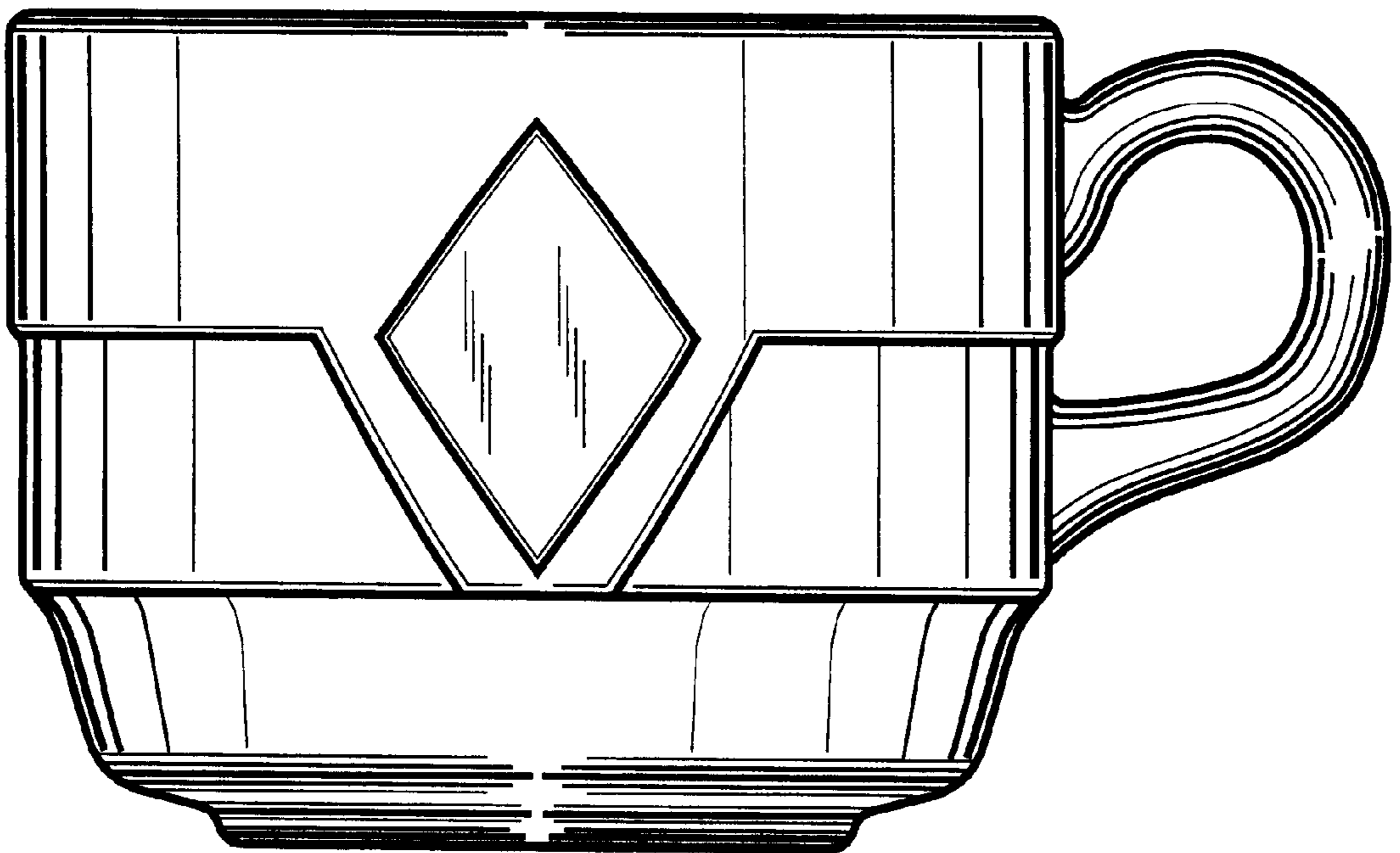

— FIG. 1

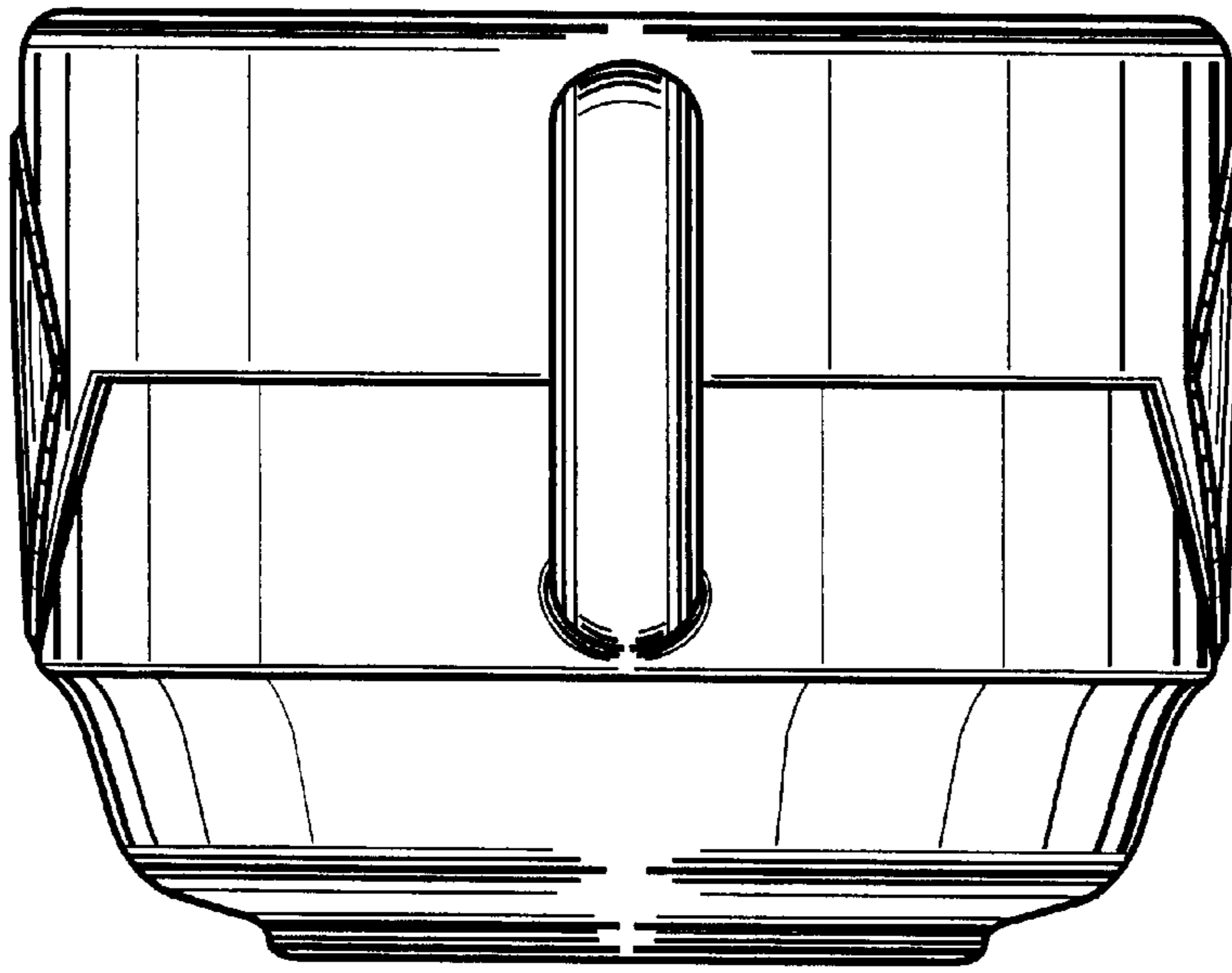

—FIG. 2

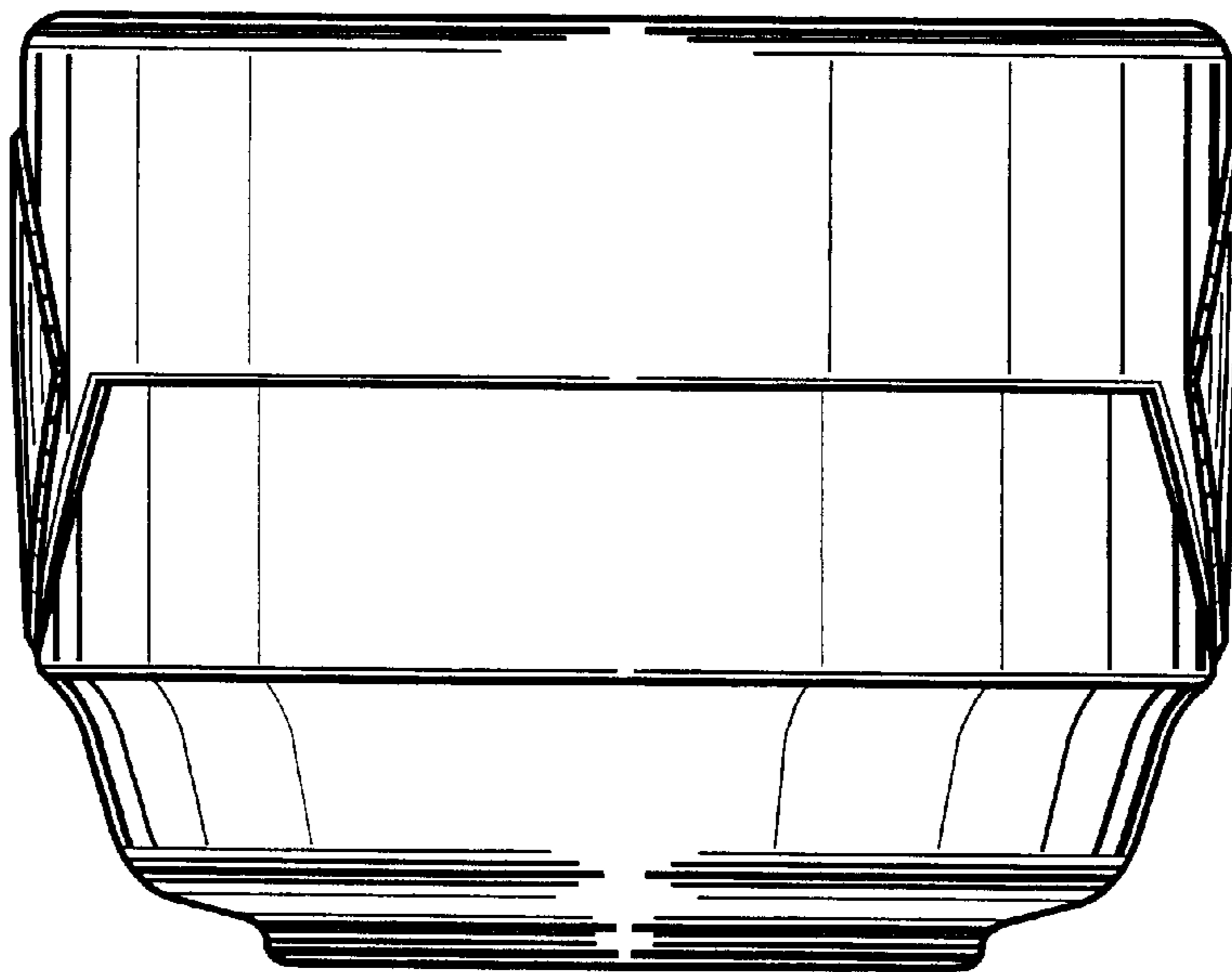

—FIG. 3

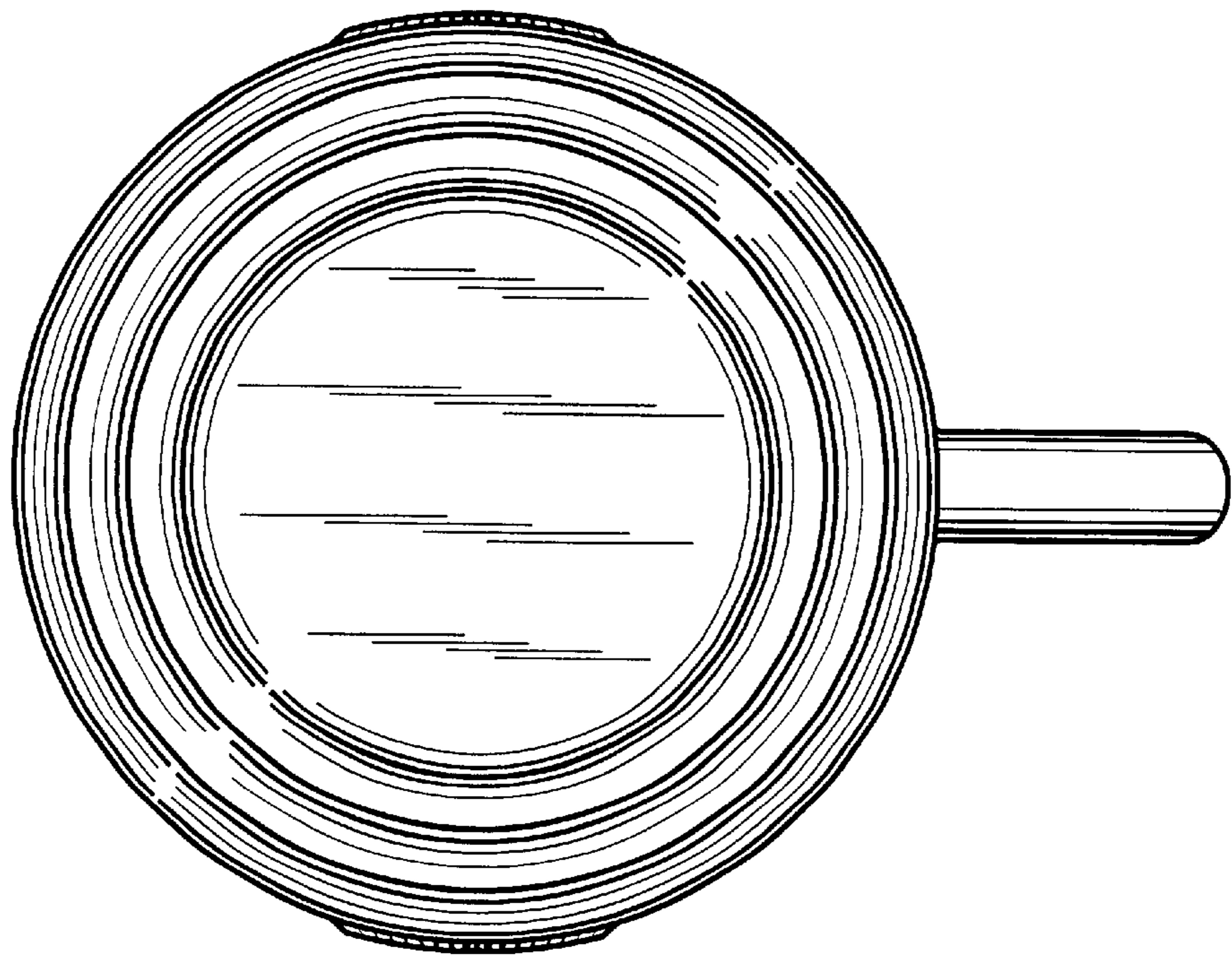

FIG. 4

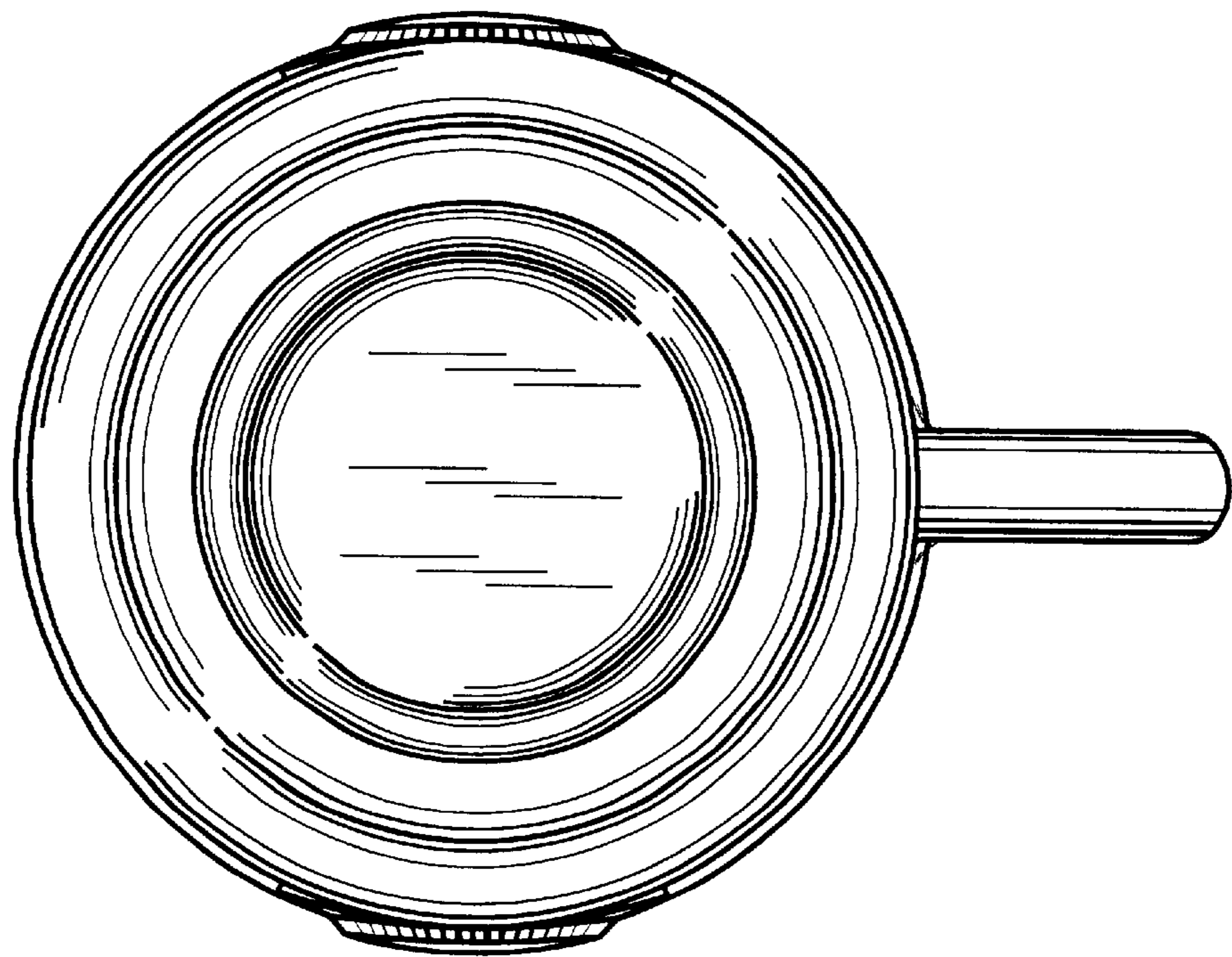
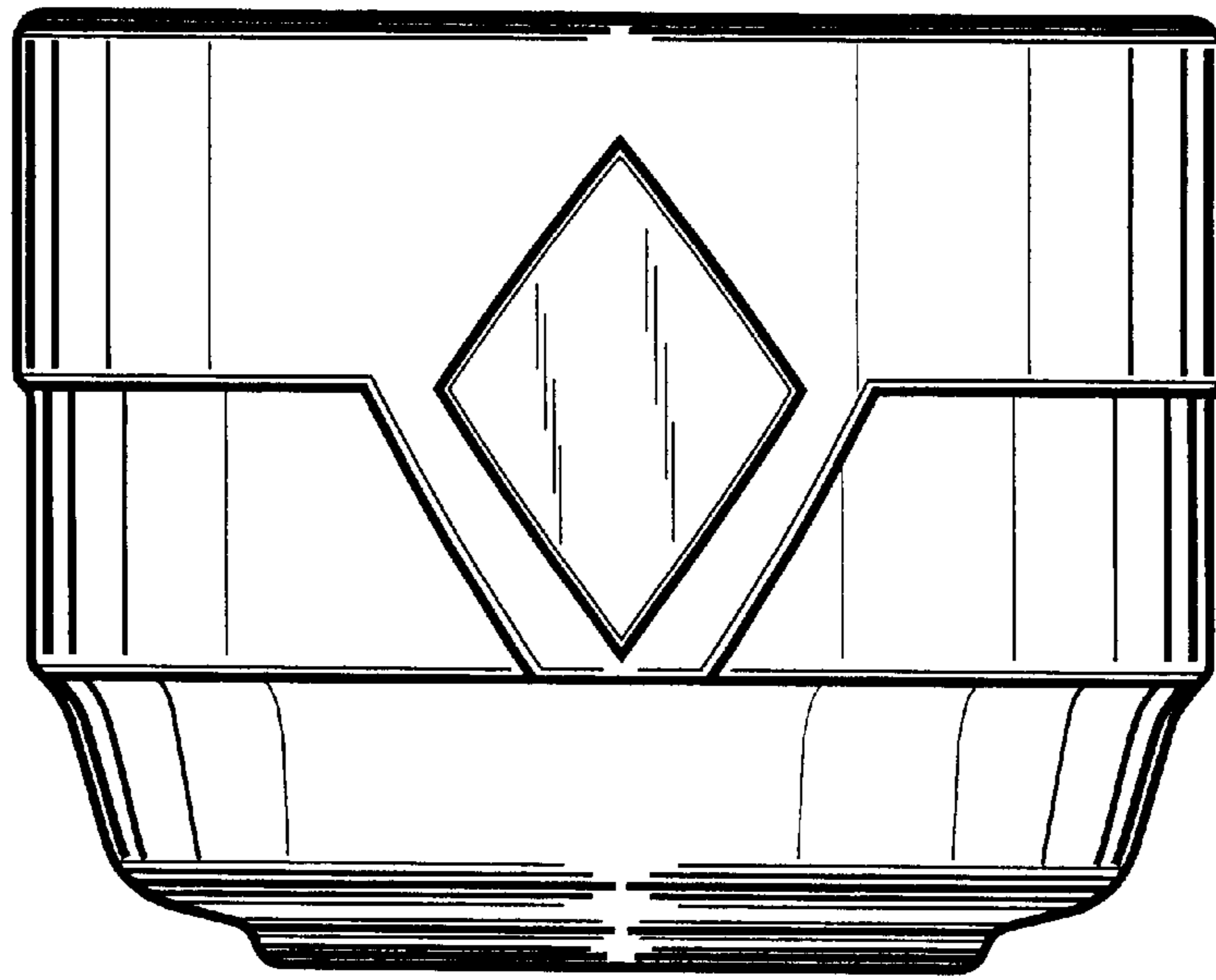
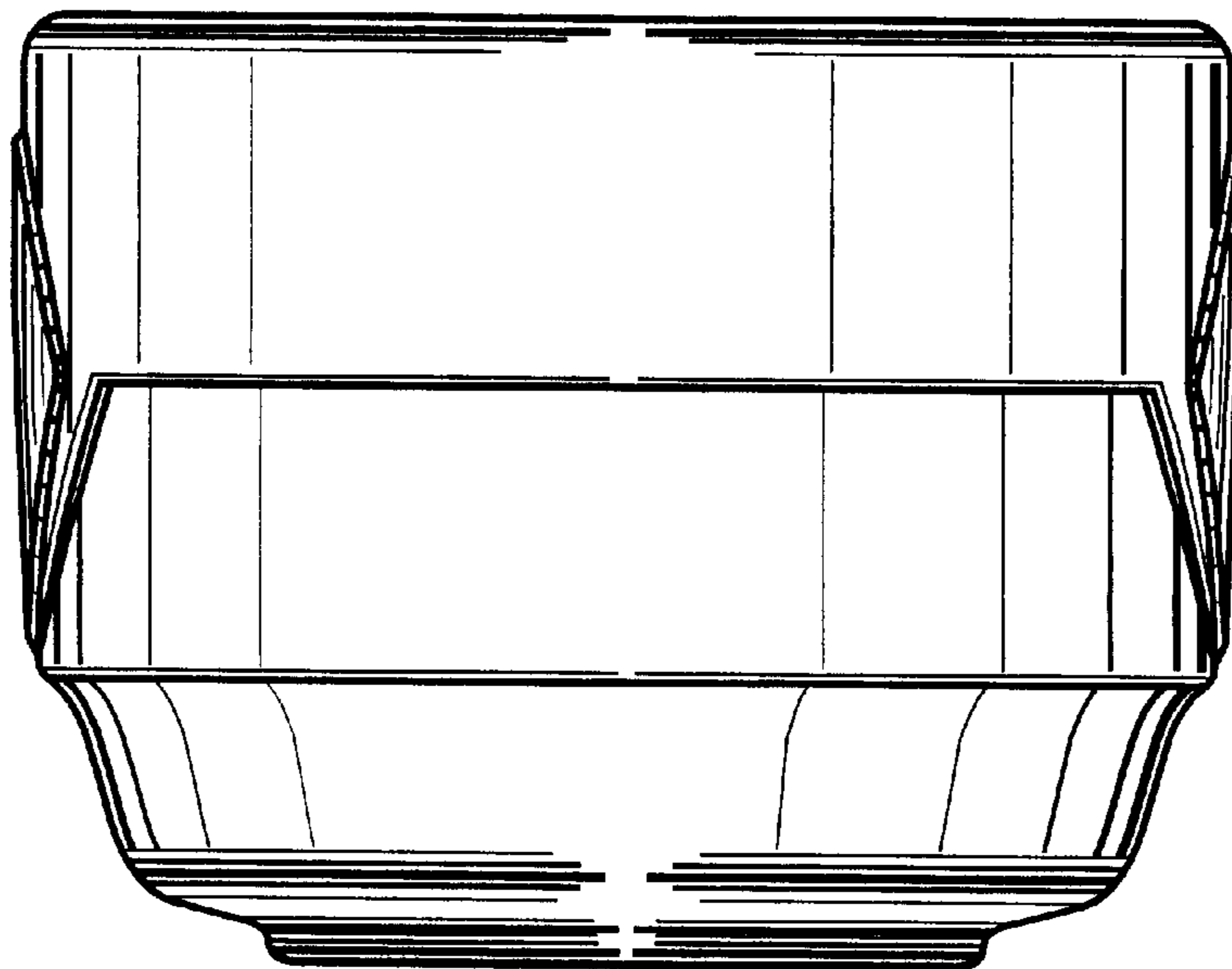

FIG. 5



— FIG. 6



— FIG. 7

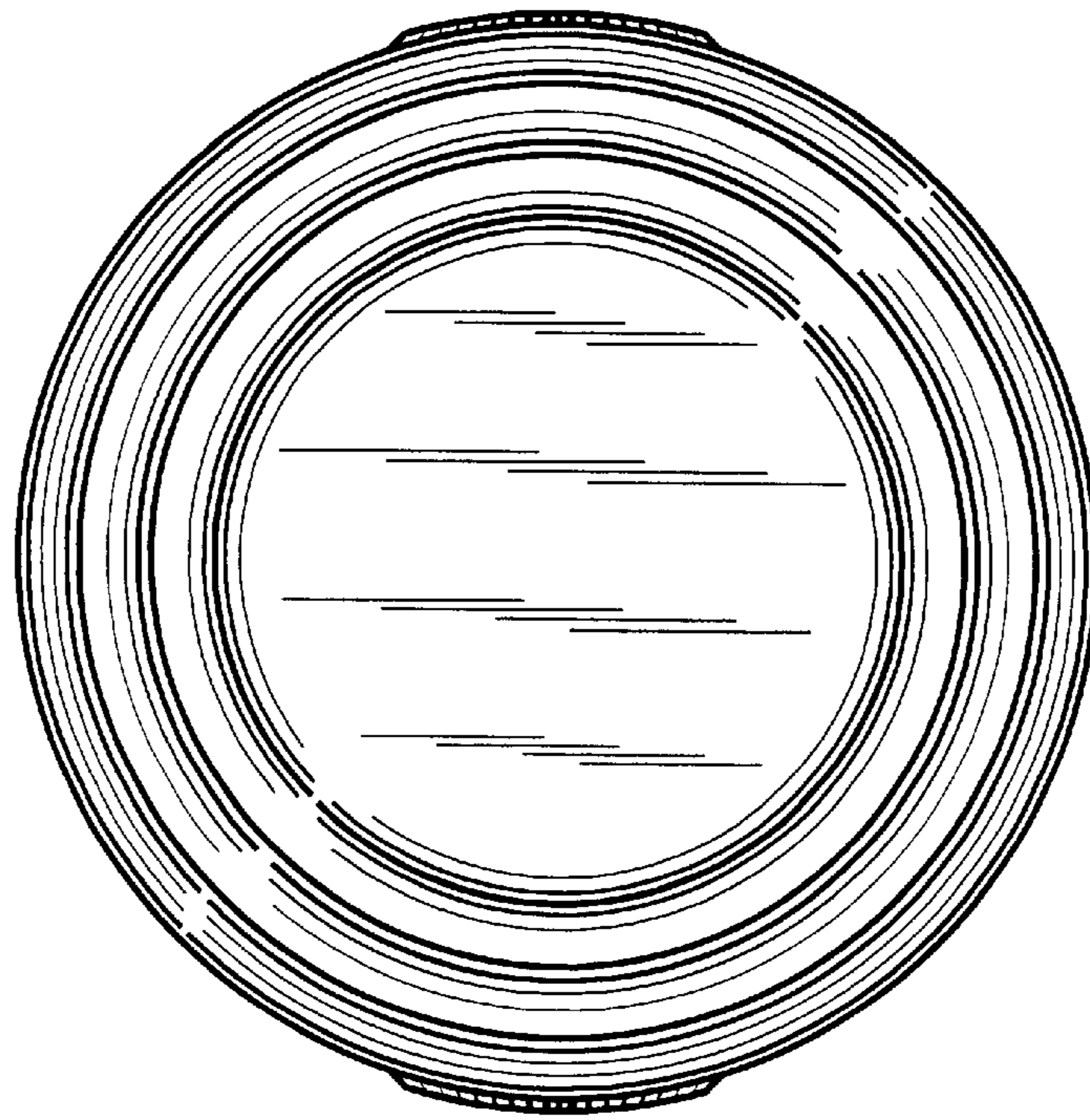

FIG. 8

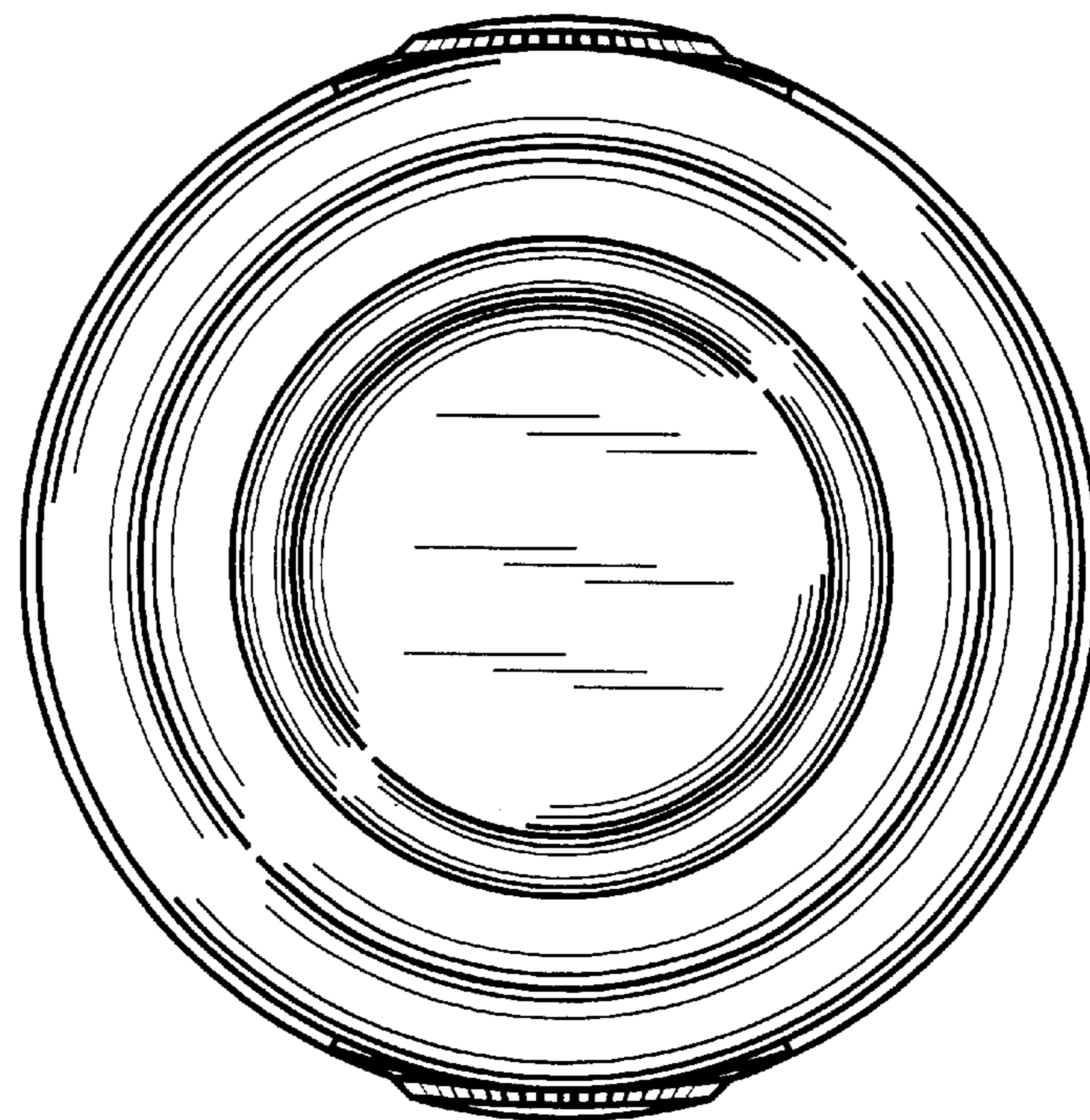

FIG. 9