



US00D482229S

(12) **United States Design Patent**
Essig et al.

(10) **Patent No.:** **US D482,229 S**

(45) **Date of Patent:** **** Nov. 18, 2003**

(54) **BEVERAGE RESERVOIR**

(75) Inventors: **John Raymond Essig**, Chatham, IL (US); **Paul J. Beveridge**, Springfield, IL (US)

(73) Assignee: **Bunn-O-Matic Corporation**, Springfield, IL (US)

(**) Term: **14 Years**

(21) Appl. No.: **29/156,416**

(22) Filed: **Feb. 28, 2002**

(51) **LOC (7) Cl.** **07-01**

(52) **U.S. Cl.** **D7/313; D7/306**

(58) **Field of Search** D7/300, 306-315; 99/275, 284, 285, 290, 292, 304, 323.3; 222/129.1, 146.6, 166, 465.1, 466, 475.1, 566, 572, 575

D429,943 S	8/2000	Yu	D7/306
D431,145 S	9/2000	Woebcke et al.	D7/306
D435,994 S	1/2001	Gaffney	D7/306
D436,282 S	1/2001	Kauzlarich et al.	D7/306
D442,009 S	5/2001	Schwarzli	D7/306
D450,214 S	11/2001	Woebcke et al.	D7/306

OTHER PUBLICATIONS

The Republic Metalware Co., Catalogue 78, 1914; pp. 252, 259, and 313 (Section 16); Items—Cans, Ash—Engineer's top of page, Cans, Waste bottom of page, and Oil Tanks only one on page.*

* cited by examiner

Primary Examiner—Caron D. Veynar

(74) *Attorney, Agent, or Firm*—Barnes & Thornburg

(57) **CLAIM**

We claim the ornamental design for a beverage reservoir, as shown and described.

DESCRIPTION

FIG. 1 is a perspective view of the beverage reservoir; FIG. 2 is a top view thereof; FIG. 3 is a bottom view thereof; FIG. 4 is a front view thereof; FIG. 5 is a rear view thereof; FIG. 6 is a left side view thereof; FIG. 7 is a right side view thereof; FIG. 8 is a perspective view of a second embodiment of the beverage reservoir; FIG. 9 is a top view thereof; FIG. 10 is a bottom view thereof; FIG. 11 is a front view thereof; FIG. 12 is a rear view thereof; FIG. 13 is a left side view thereof; and, FIG. 14 is a right side view thereof. The broken lines in the figures are for illustrative purposes only and form no part of the claimed design.

1 Claim, 6 Drawing Sheets

(56) **References Cited**

U.S. PATENT DOCUMENTS

D192,529 S	4/1962	Painter	
D192,530 S	4/1962	Painter	
D199,408 S	10/1964	Felske	
D200,655 S	3/1965	De Fano	
D203,709 S	2/1966	Yamasaki et al.	
D248,717 S	8/1978	Little	
D248,718 S	8/1978	Little	
D262,711 S	1/1982	Cox et al. D15/112
D276,499 S	11/1984	Kamada et al. D9/325
D286,097 S	10/1986	Imanishi et al. D34/39
D298,602 S	11/1988	Price D7/313
D300,595 S	* 4/1989	Boxall D7/307
D309,847 S	8/1990	Scheurer D7/606
D335,744 S	5/1993	Small et al. D34/39
D356,713 S	3/1995	Groover D7/306
D358,289 S	5/1995	Thies et al. D7/306
D362,990 S	10/1995	Losordo D7/305
D386,933 S	12/1997	Browne D7/312
D400,390 S	11/1998	Gebhard D7/313
D419,822 S	2/2000	Woodyard D7/313

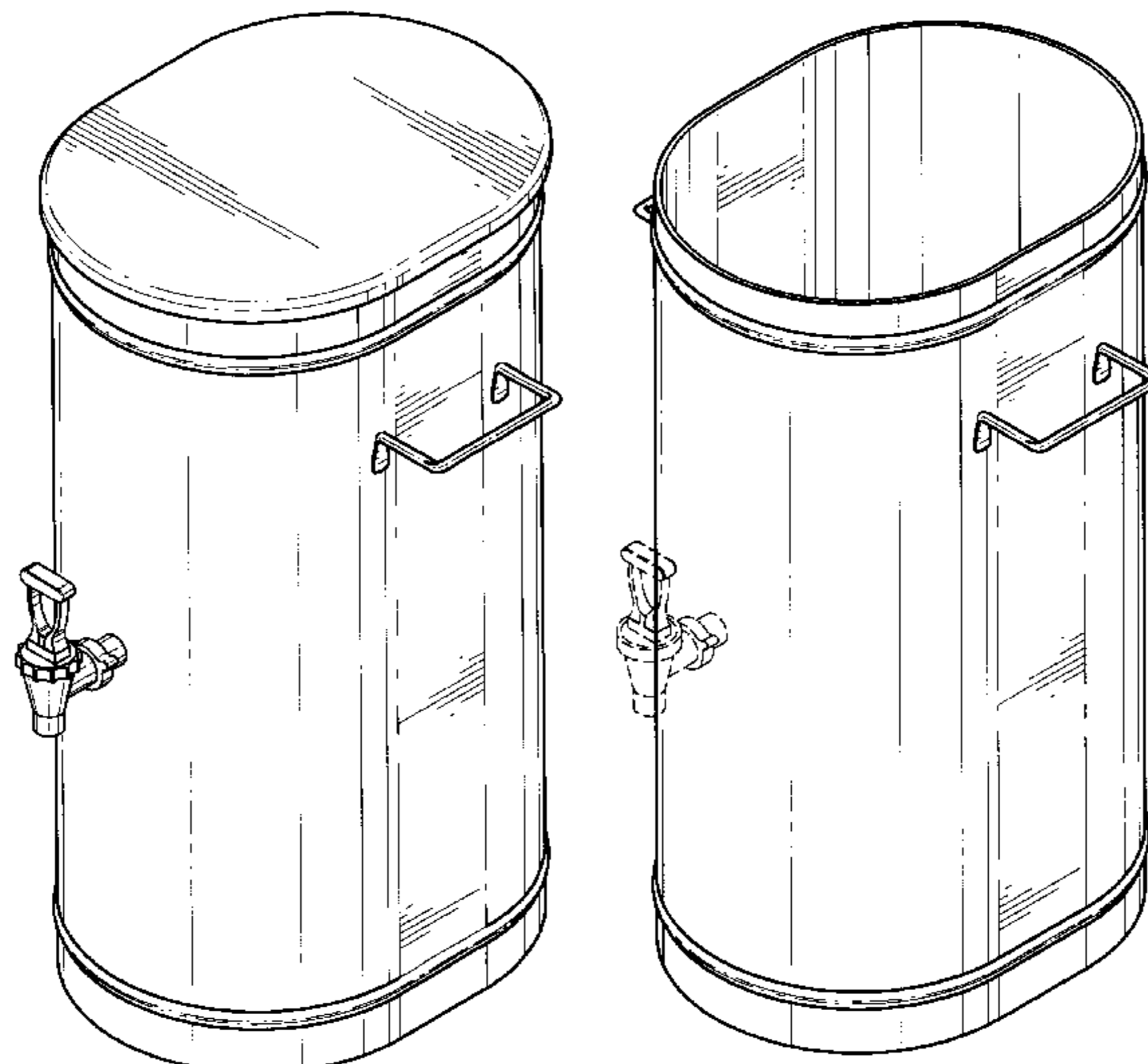

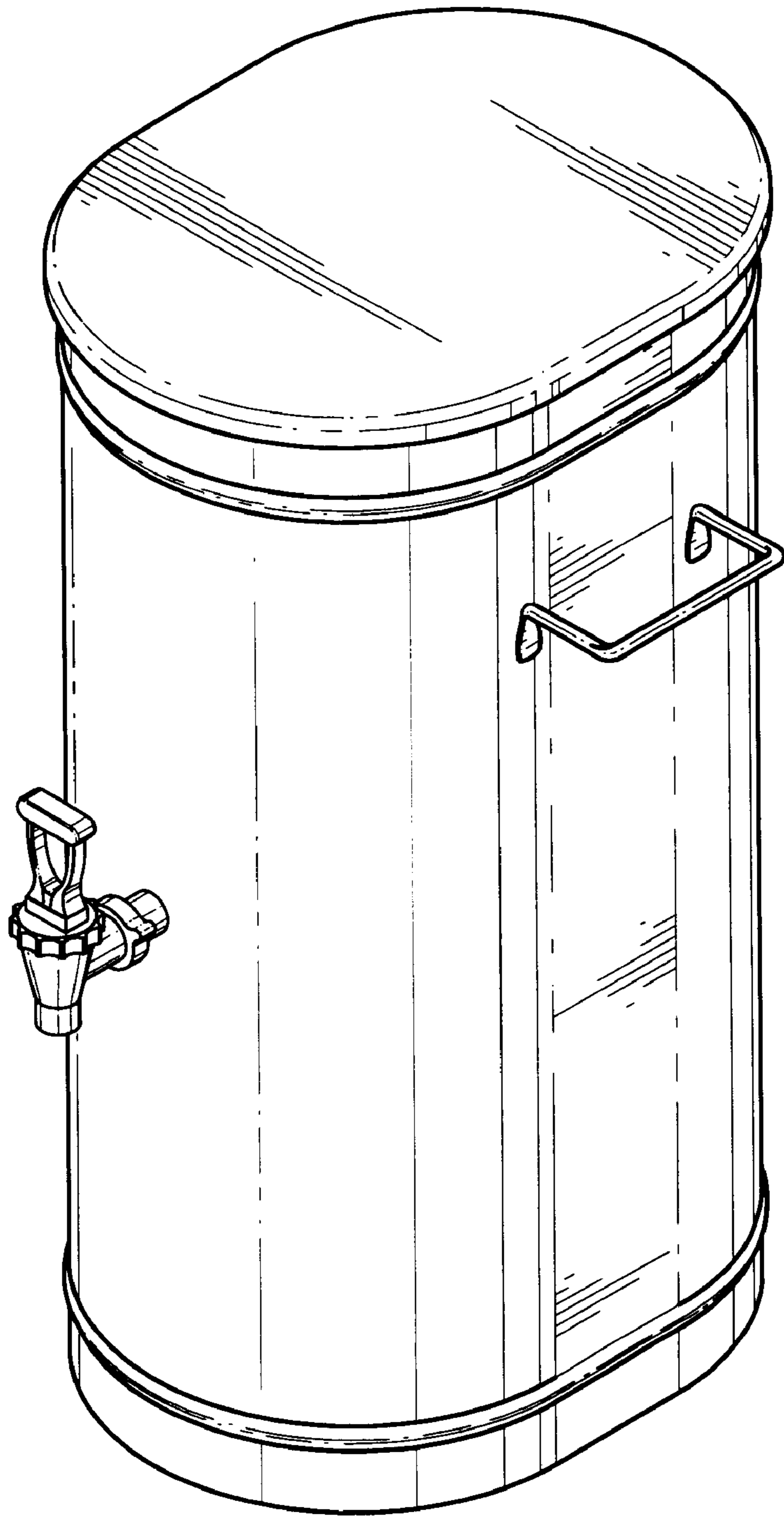

FIG. 1

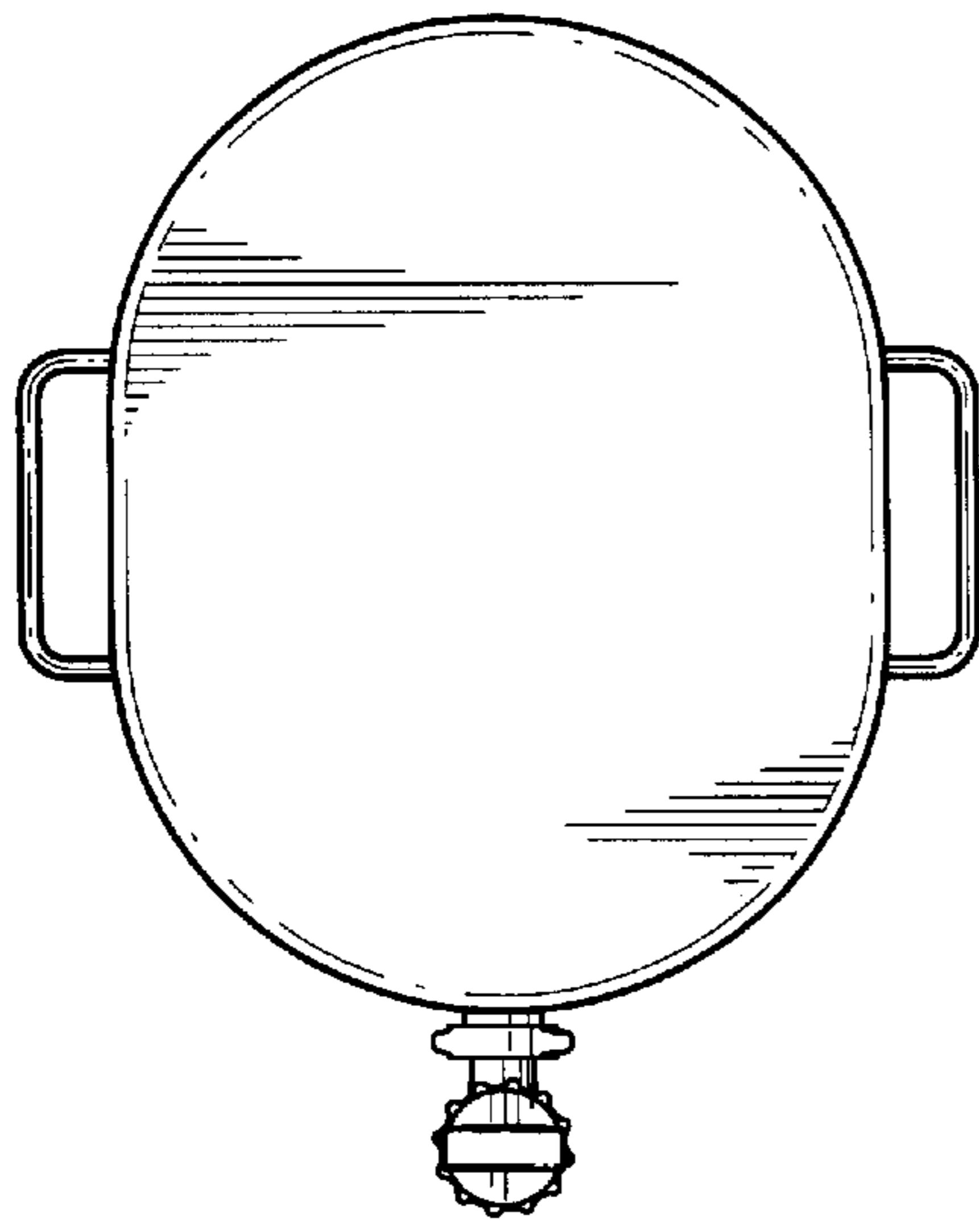

FIG. 2

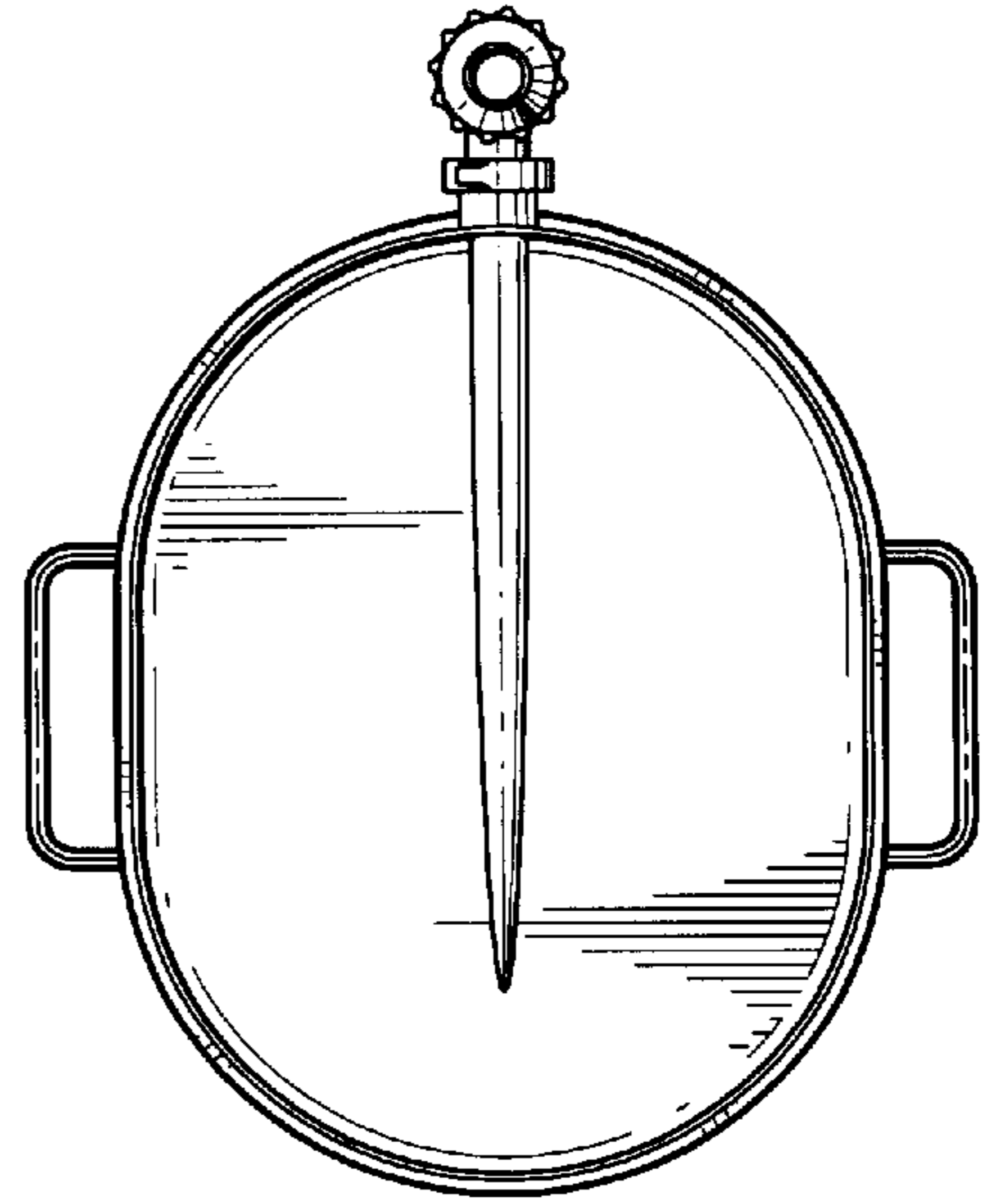

FIG. 3

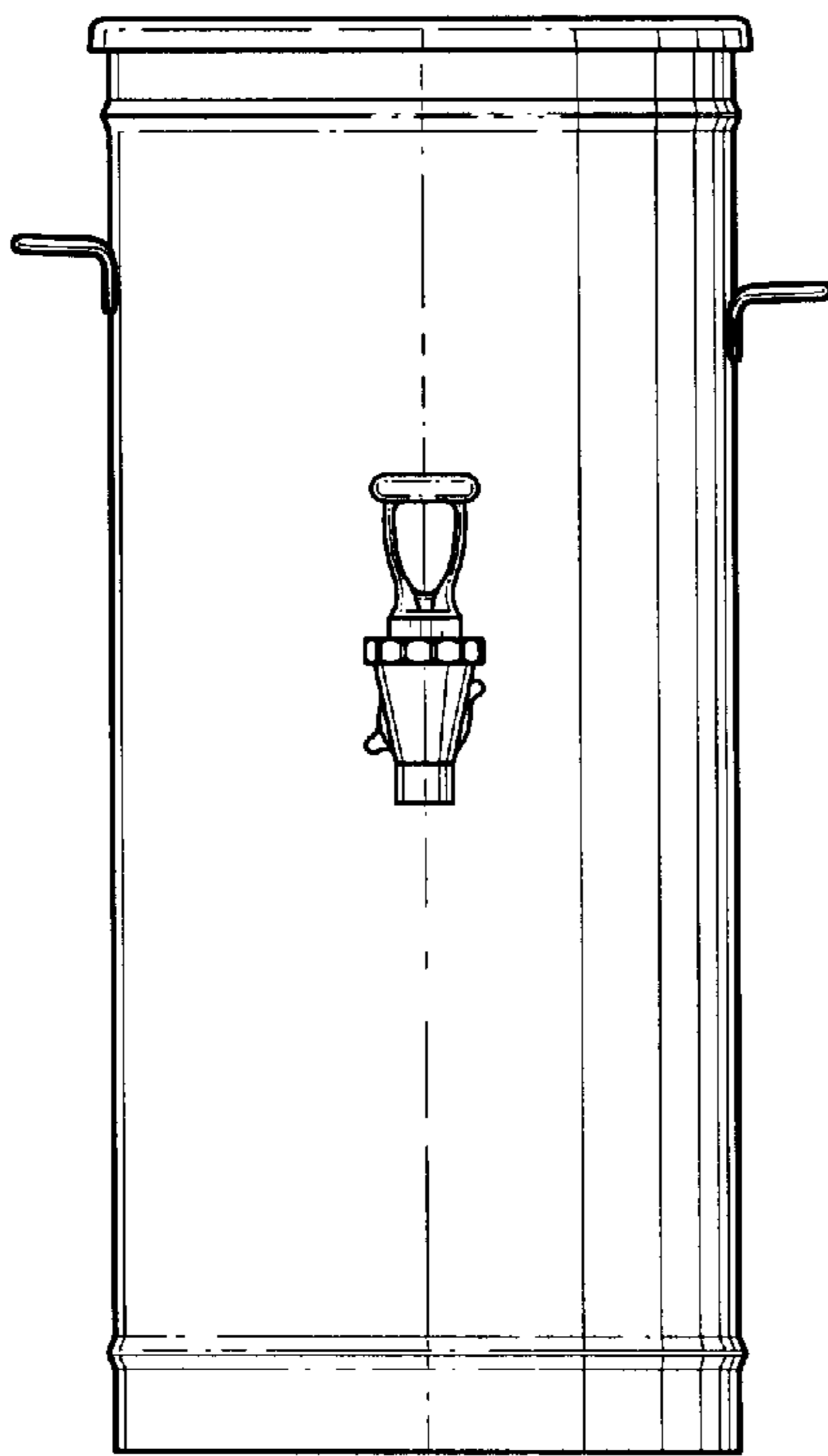

FIG. 4

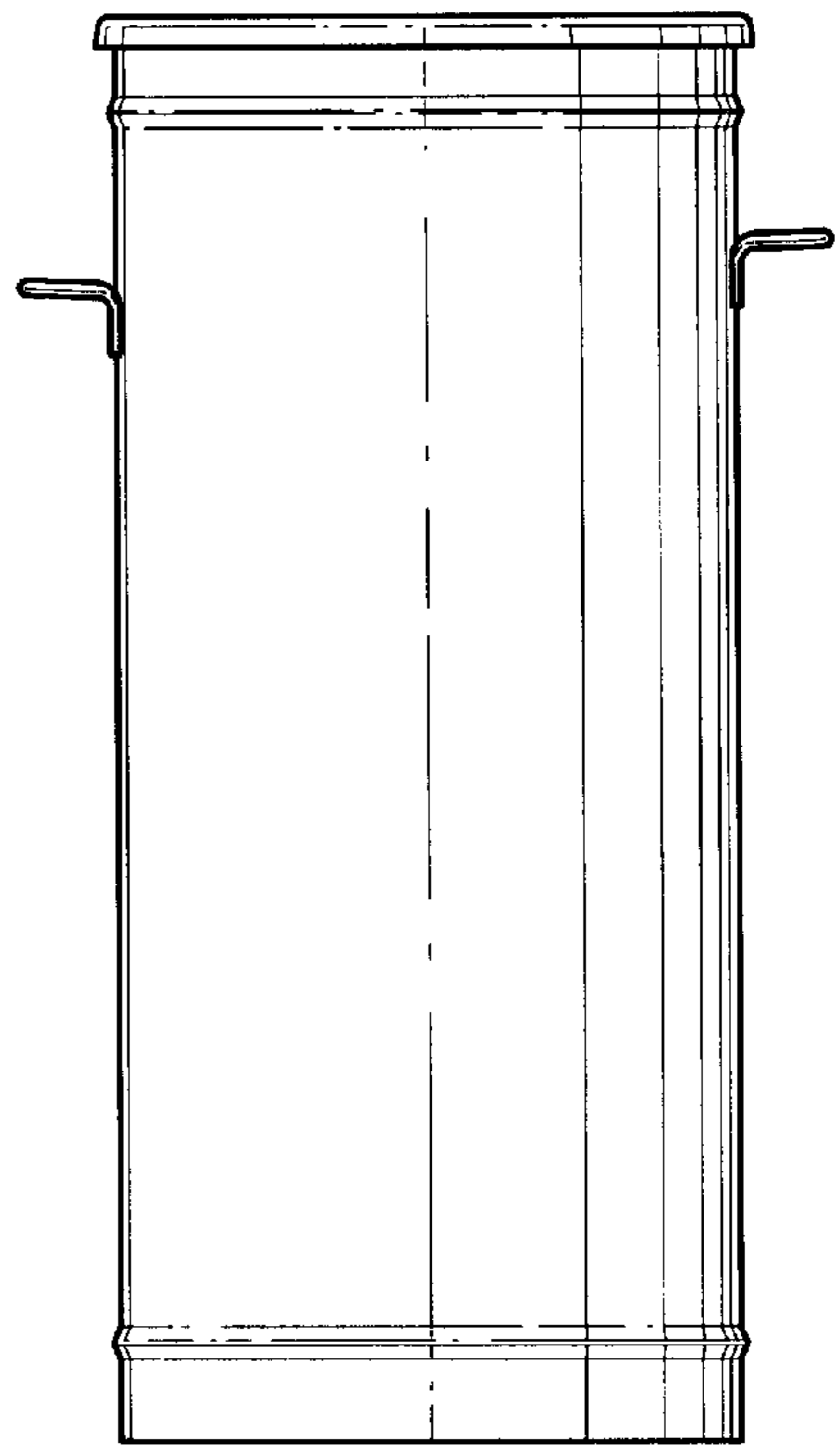

FIG. 5

FIG. 6

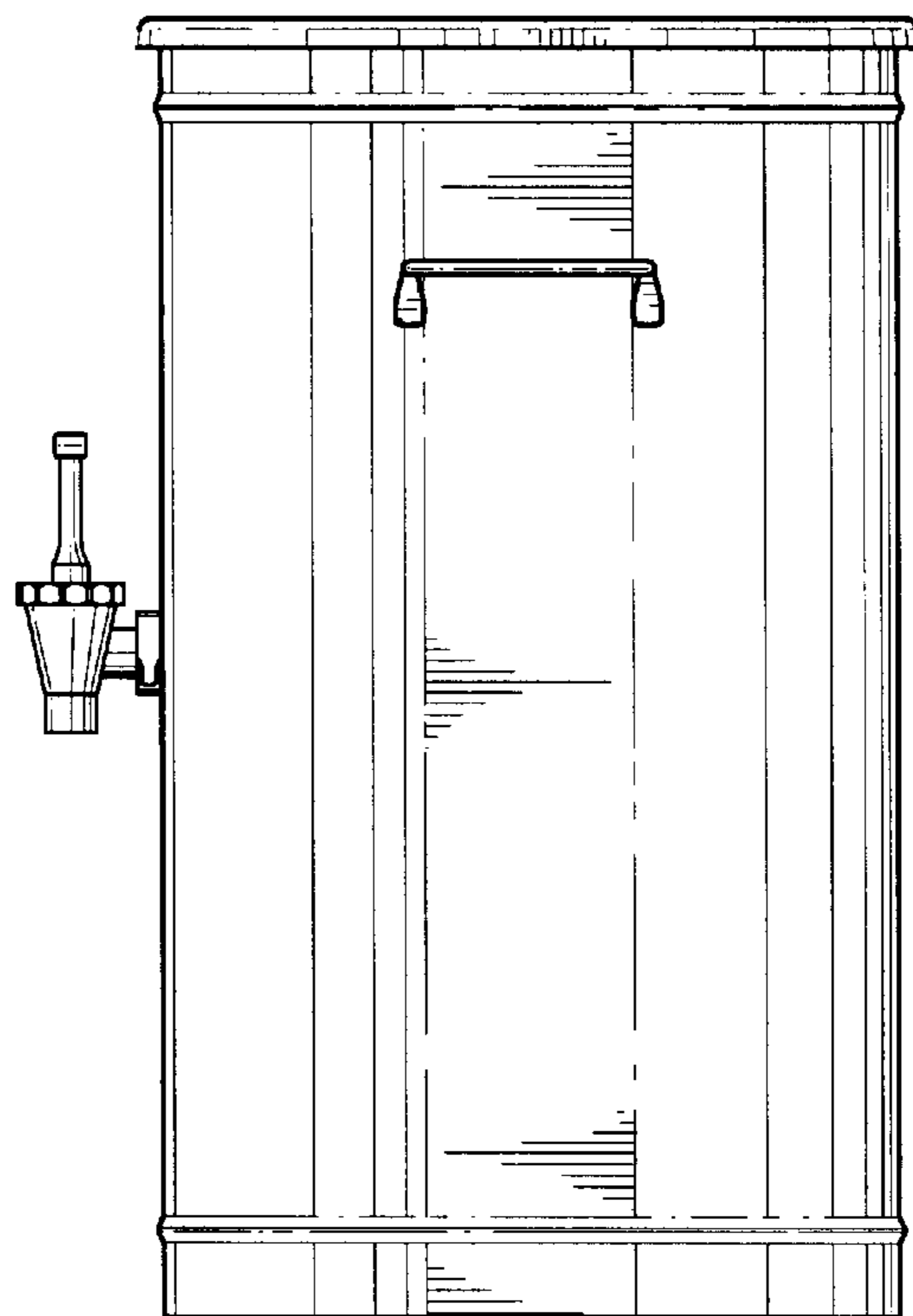
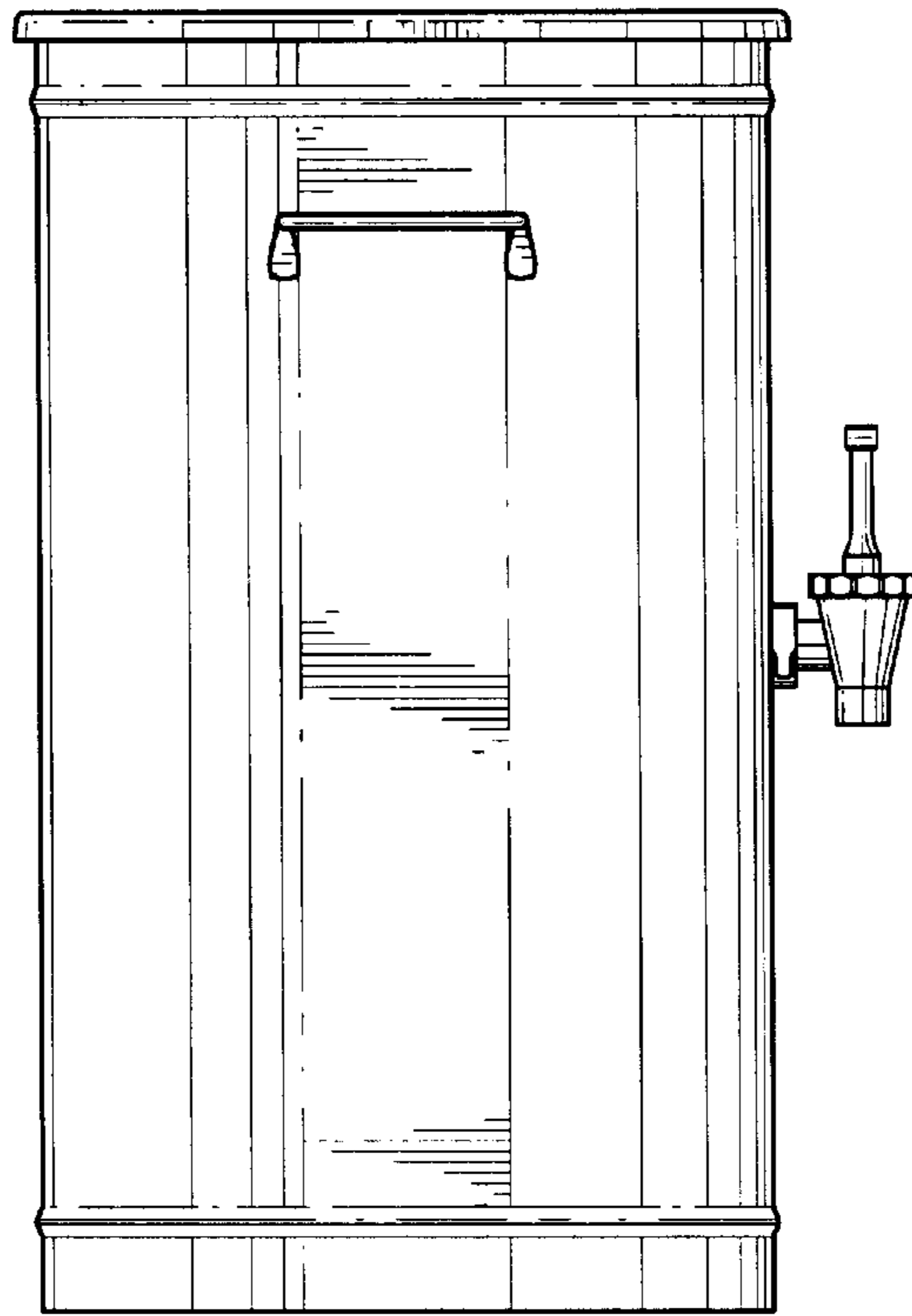

FIG. 7

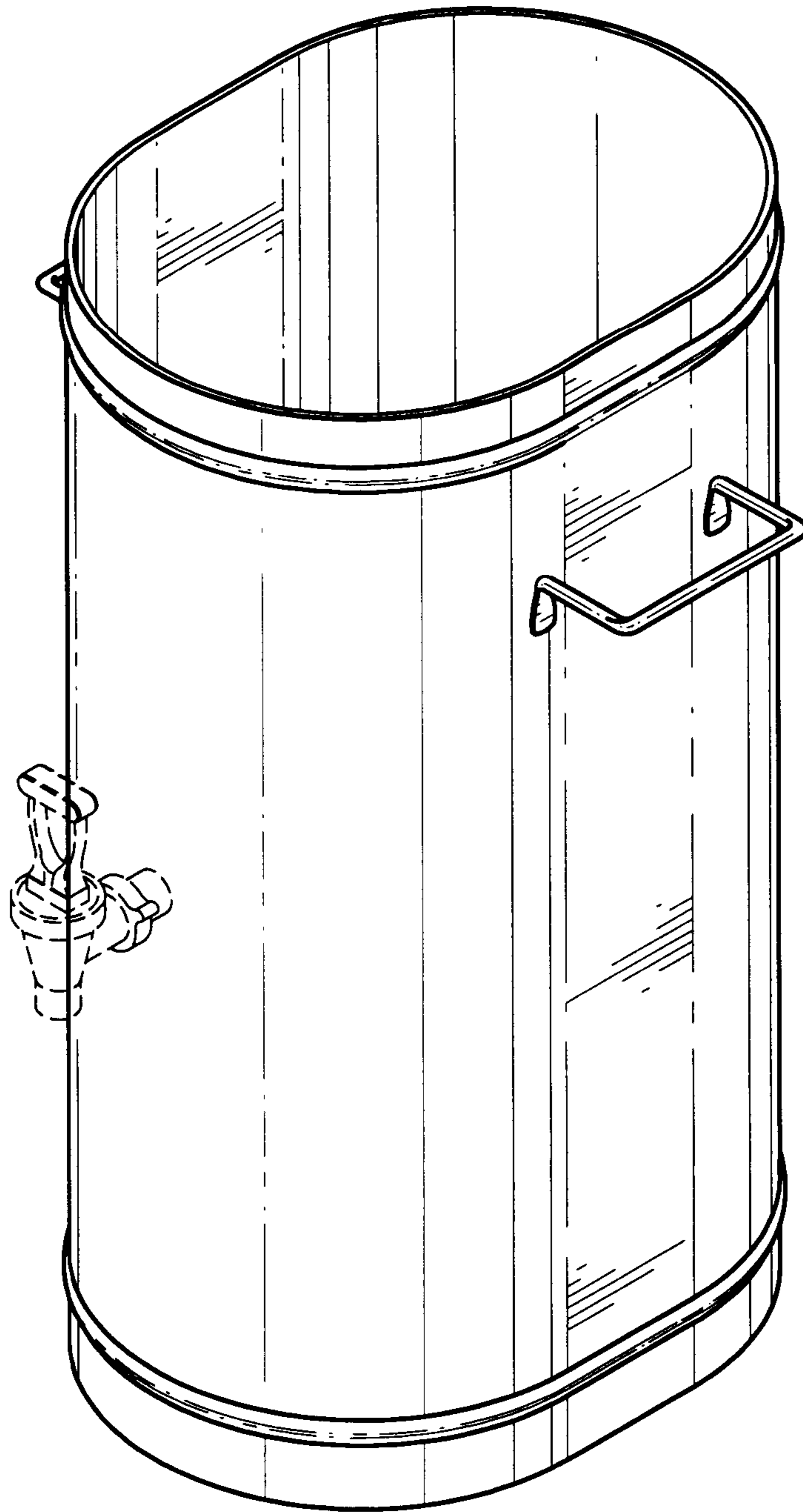

FIG. 8

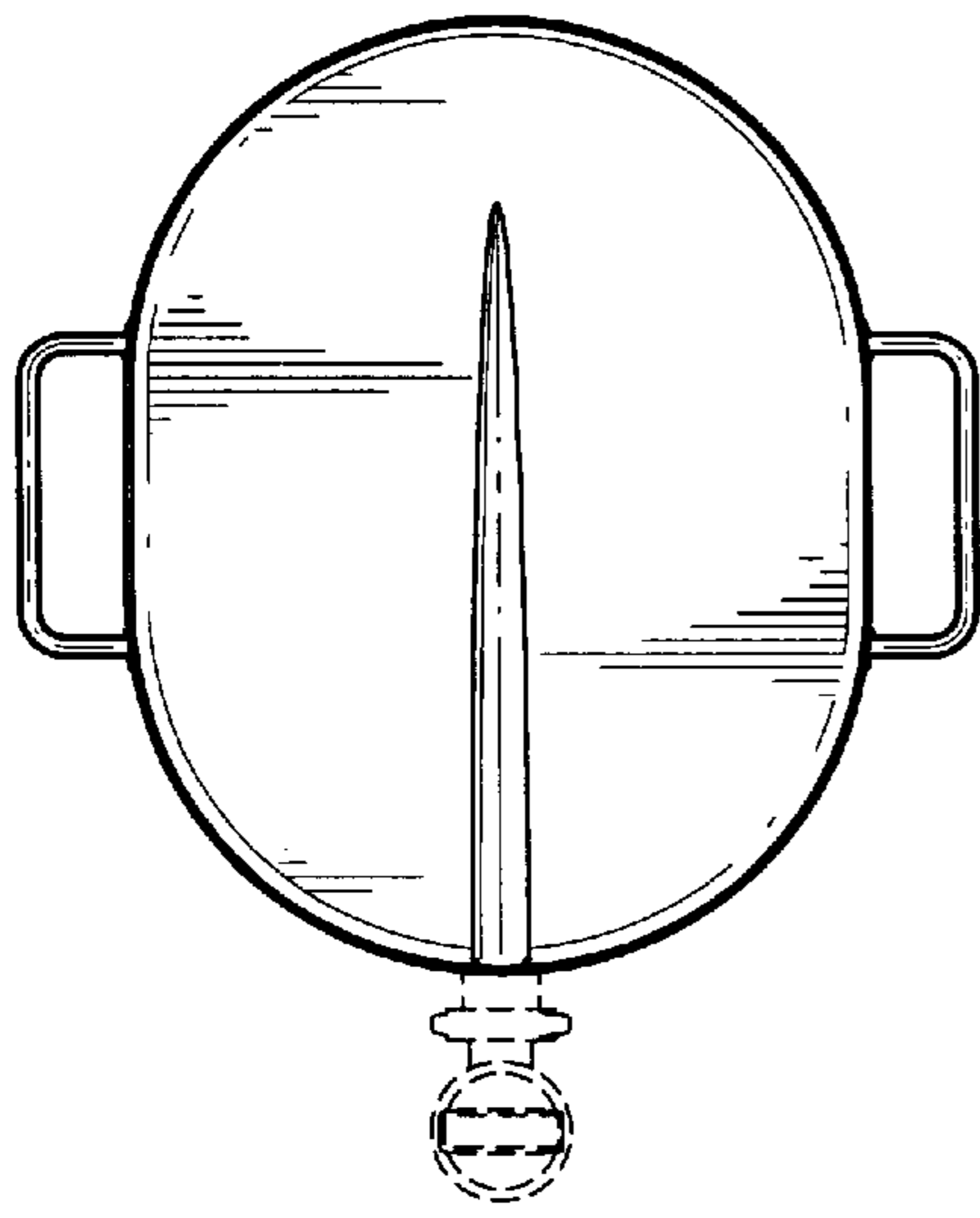

FIG. 9

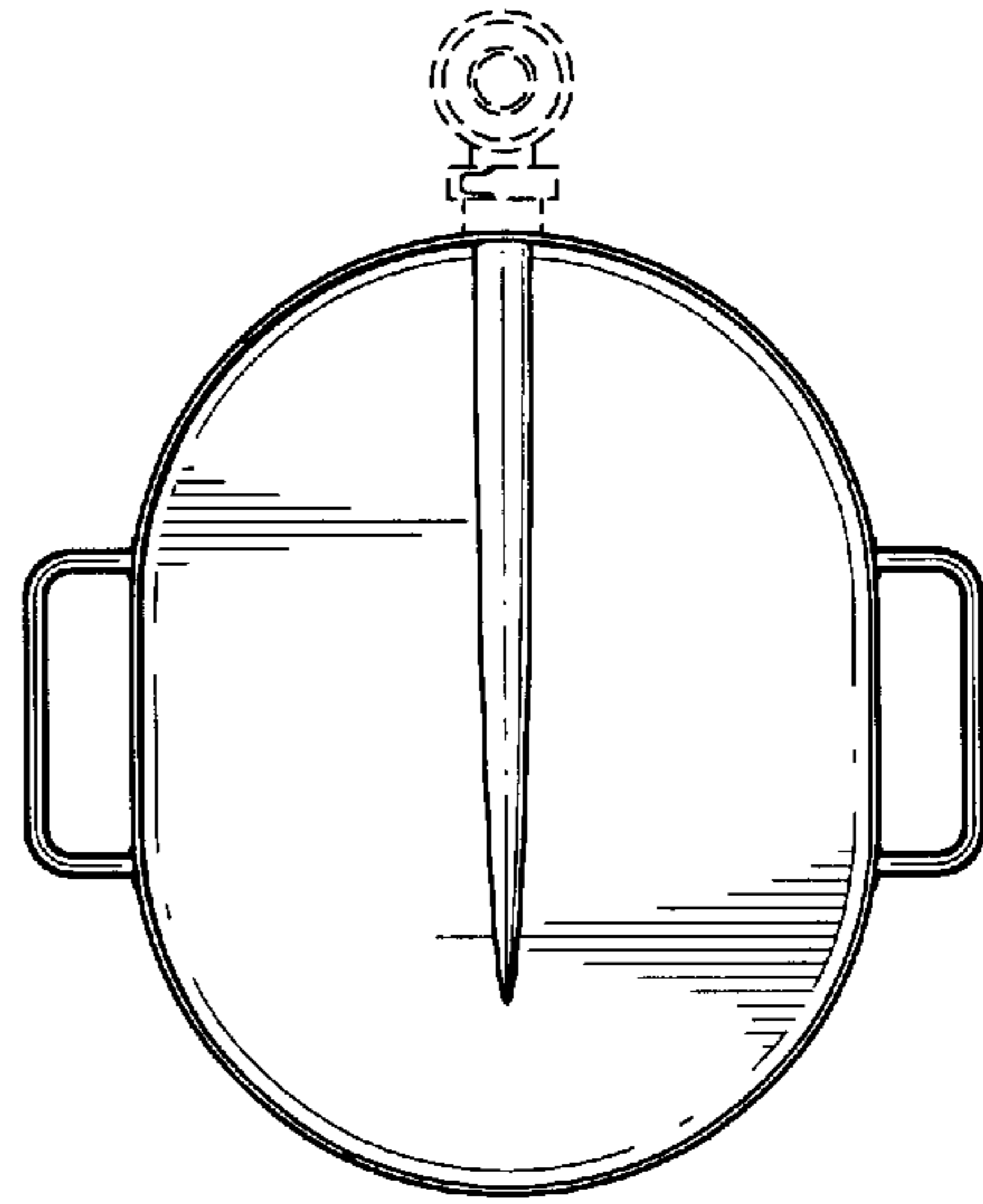

FIG. 10

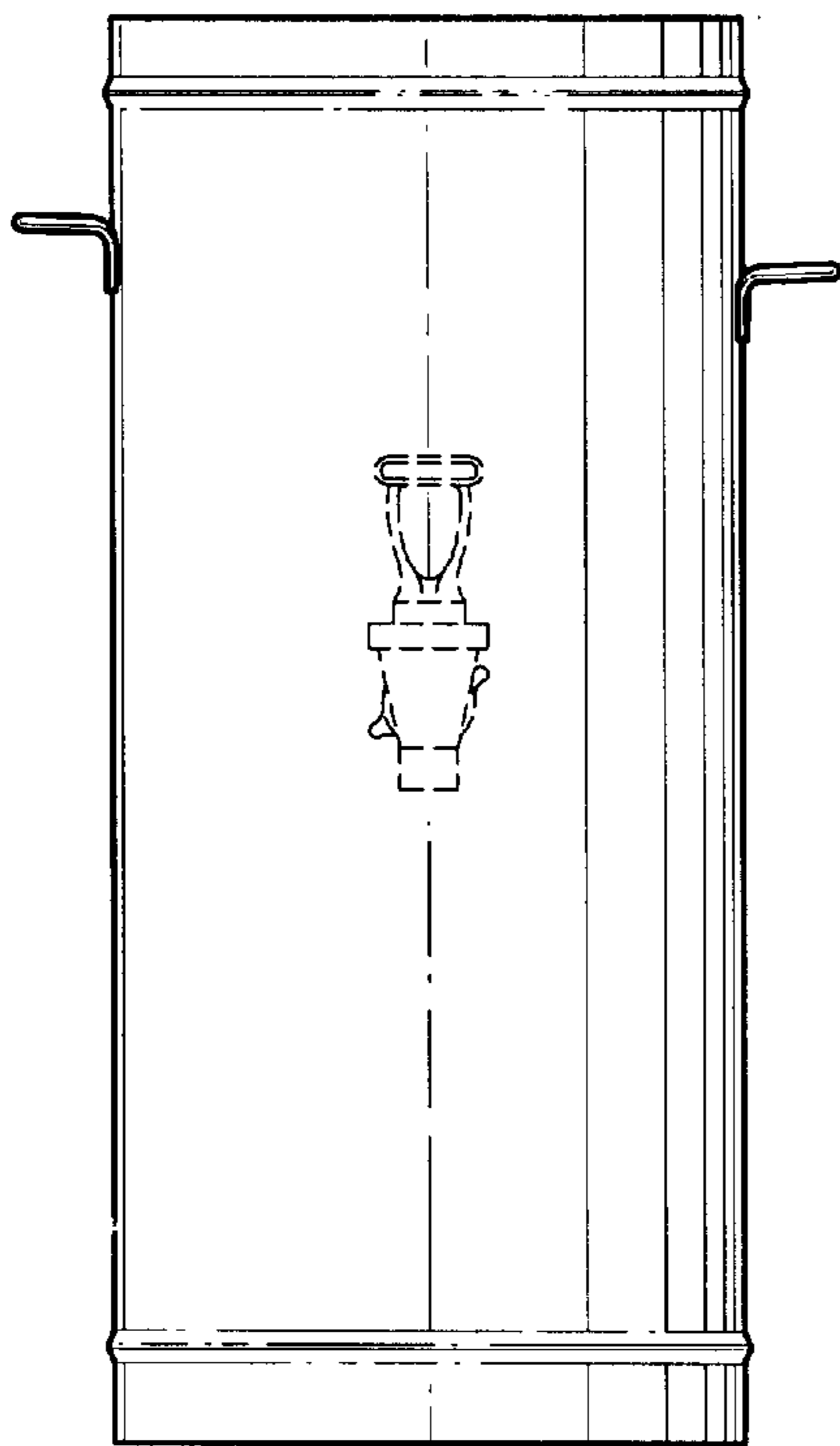

FIG. 11

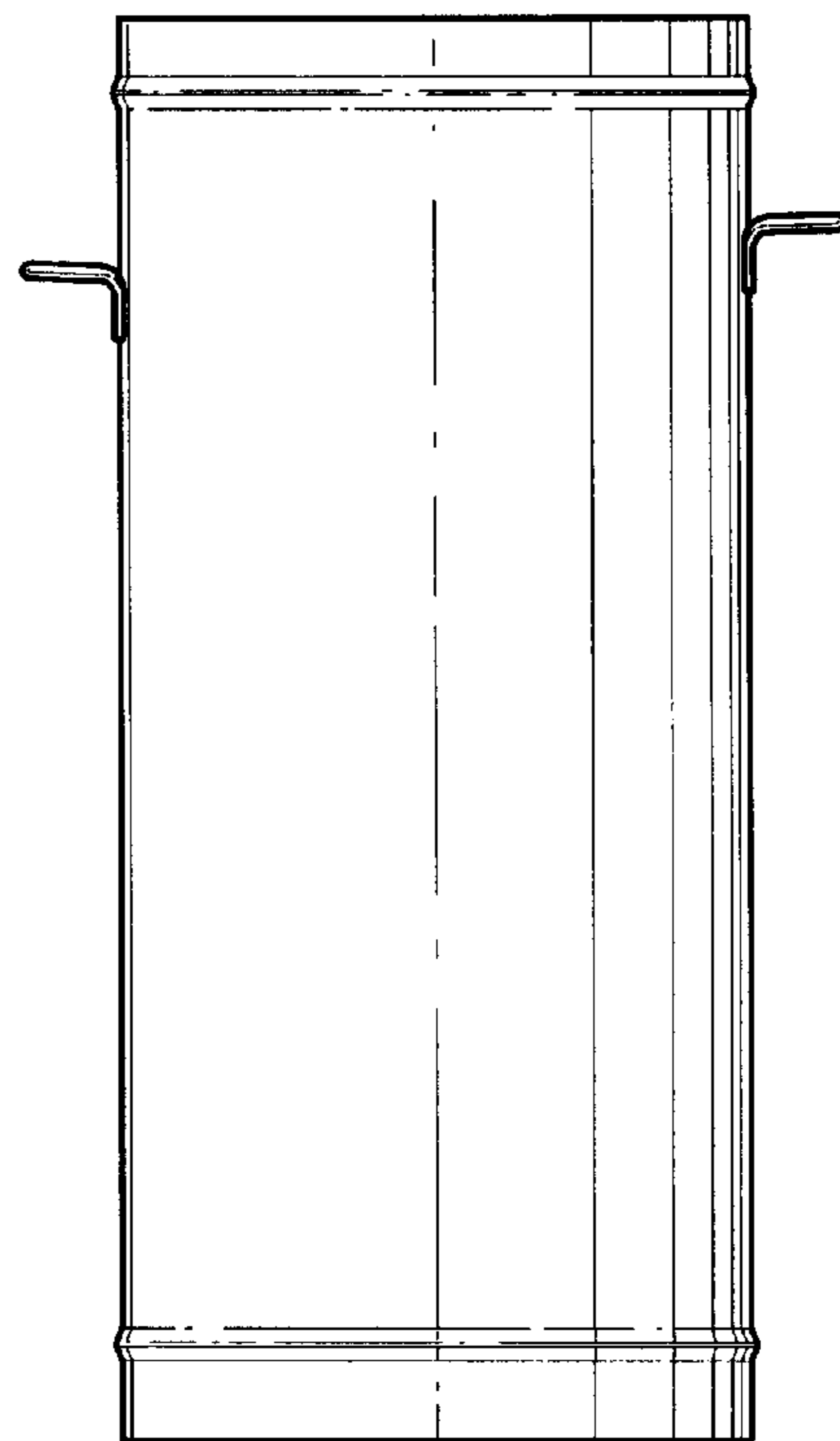

FIG. 12

FIG. 13

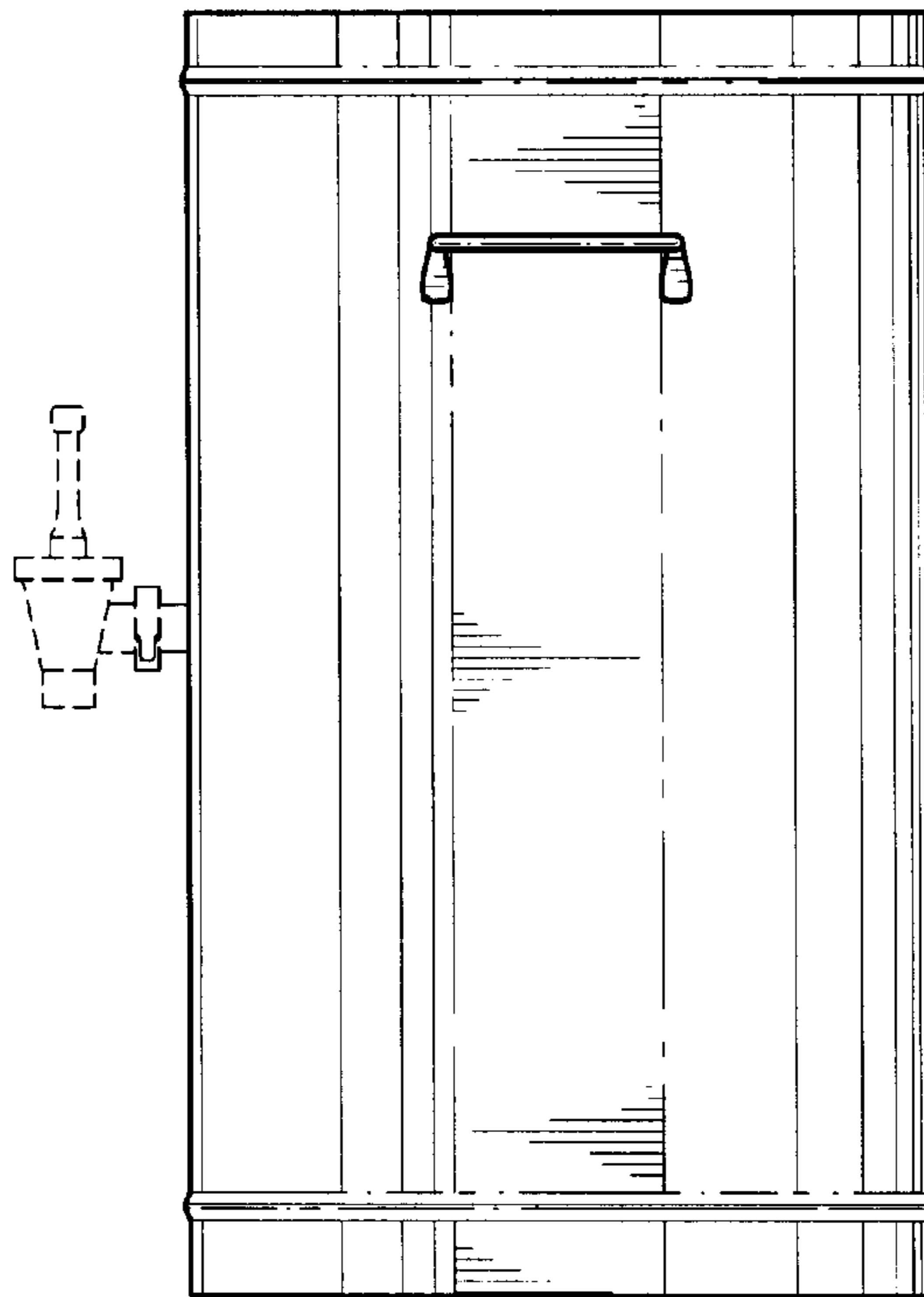
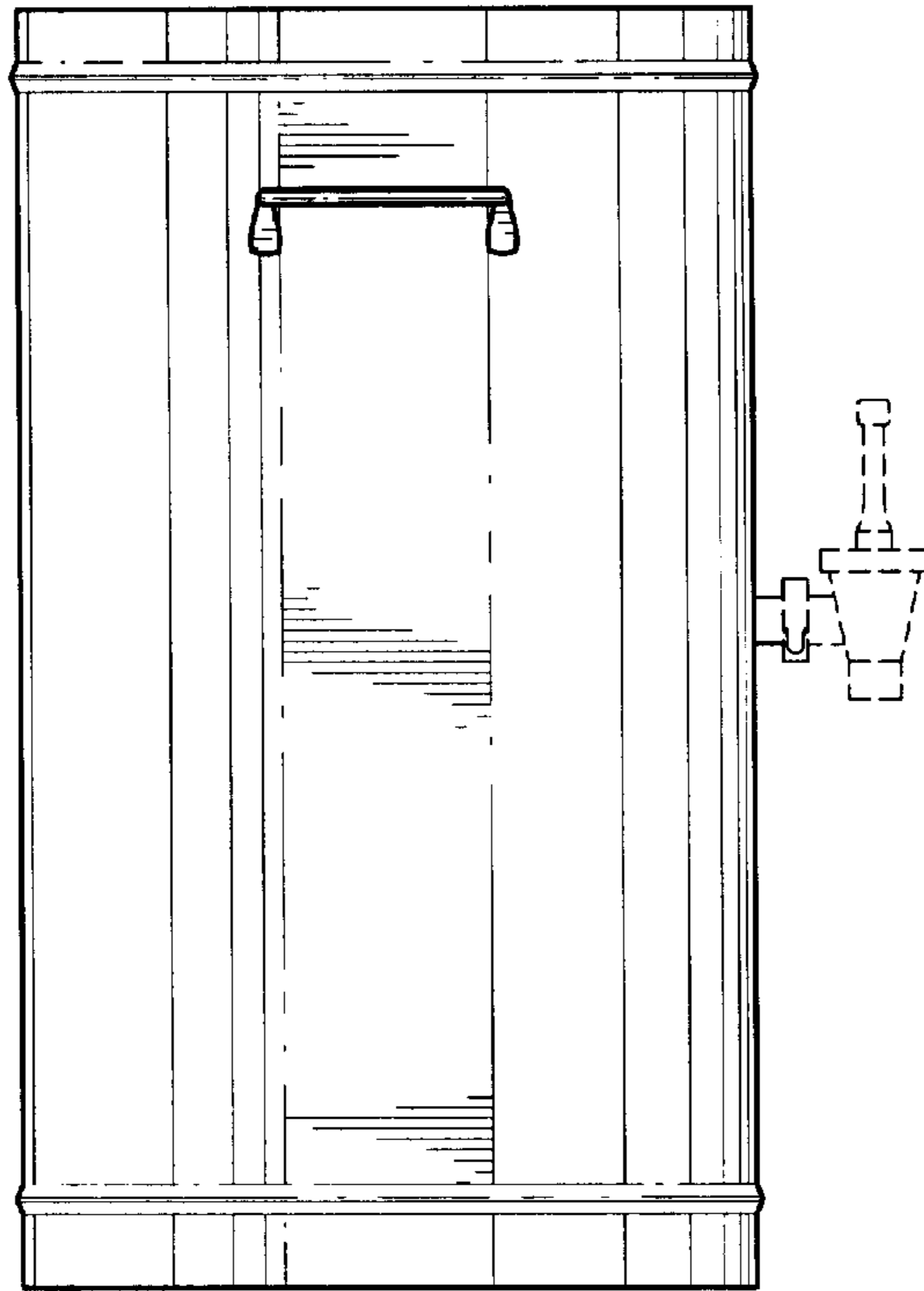

FIG. 14