



US00D482203S

(12) **United States Design Patent**
Goulet

(10) **Patent No.: US D482,203 S**

(45) **Date of Patent: ** Nov. 18, 2003**

- (54) **PAINT APPLICATOR HANDLE**
- (75) Inventor: **Matthew G. Goulet**, Milwaukee, WI (US)
- (73) Assignee: **Newell Operating Company**, Freeport, IL (US)
- (**) Term: **14 Years**
- (21) Appl. No.: **29/158,076**
- (22) Filed: **Mar. 28, 2002**
- (51) **LOC (7) Cl. 04-04**
- (52) **U.S. Cl. D4/138**
- (58) **Field of Search** D4/132, 135, 138; D7/393, 395, 401.2; D8/107, DIG. 4, DIG. 6-DIG. 8, 80; 15/143.1, 144.1, 144.2, 168, 169, 171, 175, 191.1, 192, 193; 16/110.1, 430, 431

- D211,446 S 6/1968 Hange
- D216,247 S 12/1969 McGuire
- D223,017 S 2/1972 Pharris
- 3,819,779 A 6/1974 Pharris et al.
- D240,678 S 7/1976 Herig
- 4,454,623 A 6/1984 O'Halloran
- 4,481,689 A 11/1984 Westmoreland
- 4,490,875 A 1/1985 Grunz
- 4,495,669 A 1/1985 Hooper
- D292,348 S 10/1987 Roberts et al.
- 4,751,762 A 6/1988 Meimeteas
- 4,847,939 A 7/1989 Derencsenyi et al.
- D309,379 S 7/1990 Dawes
- D311,455 S 10/1990 Snipes
- D324,473 S * 3/1992 Chen D8/80
- 5,155,878 A 10/1992 Dellis
- D333,217 S 2/1993 Gingras
- D347,327 S 5/1994 Ricciarelli et al.
- 5,339,482 A 8/1994 Desimone et al.
- 5,343,585 A 9/1994 Howell
- 5,390,572 A 2/1995 Gakhar et al.
- 5,446,941 A 9/1995 Kelsay
- 5,465,449 A 11/1995 Lewkowicz
- D367,963 S 3/1996 Mayer
- 5,556,092 A 9/1996 Theken
- 5,615,445 A 4/1997 Kelsay et al.
- 5,692,265 A 12/1997 Dalury
- 5,761,759 A 6/1998 Leversby et al.
- 5,761,767 A 6/1998 Barton
- 5,829,099 A 11/1998 Kopelman et al.
- 5,850,663 A 12/1998 Hardy et al.
- 5,873,148 A 2/1999 Arnold
- 5,920,943 A 7/1999 Barker
- 6,138,313 A * 10/2000 Barton et al. 15/143.1
- 6,145,151 A 11/2000 Herron et al.
- D439,417 S 3/2001 Woodnorth et al.

(56) **References Cited**

U.S. PATENT DOCUMENTS

- 375,773 A 1/1888 Rockwell
- 376,540 A 1/1888 McQuide
- 412,479 A 10/1889 Davis
- D30,616 S 4/1899 Bentzinger
- D31,122 S 7/1899 Kelly
- 673,506 A 5/1901 Pitts
- 1,054,709 A 3/1913 Munro
- 1,687,335 A 10/1928 Jackline
- 1,826,165 A 10/1931 Cartwright
- 1,838,958 A 12/1931 Page
- 1,888,930 A 11/1932 McMillan
- D119,261 S * 3/1940 Gurrieri D8/DIG. 6
- 2,236,034 A 3/1941 Luce et al.
- 2,237,969 A 4/1941 Olsen
- 2,263,885 A 11/1941 McGauley
- 2,304,319 A 12/1942 Saltzman
- 2,426,315 A 8/1947 Marick
- D167,775 S 9/1952 Schmidt
- 2,664,582 A 1/1954 Kammann
- 2,914,785 A 12/1959 Ela
- 3,023,439 A 3/1962 Danley
- 3,067,446 A 12/1962 McGauley
- 3,153,801 A 10/1964 Weiss et al.

FOREIGN PATENT DOCUMENTS

- BE 514702 7/1954
- DE 2 256 856 5/1974
- DE 27 35 542 2/1979
- GB 351858 7/1931
- GB 844124 8/1960
- GB 2050156 1/1981
- JP 6-226193 8/1994
- JP 6-85778 12/1994
- WO WO 93/16846 9/1993



OTHER PUBLICATIONS

“One Coater Supreme—The Brush That’s Better At Both Ends!” EZ Paint, 1996, 1 page.

* cited by examiner

Primary Examiner—Alan P. Douglas

Assistant Examiner—Lavone D. Tabor

(74) *Attorney, Agent, or Firm*—Marshall, Gerstein & Borun

(57)

CLAIM

We claim the ornamental design for a paint applicator handle, as shown and described.

DESCRIPTION

This application is related to U.S. patent application Ser. No. 29/153,826 entitled Paint Applicator Handle filed on Jan. 11, 2002 by Matthew G. Goulet originally including 25 figures, the full disclosure of which is hereby incorporated by reference, U.S. patent application Ser. No. 29/153,825 entitled Paint Applicator Handle filed Jan. 11, 2002 by Mathew G. Goulet including 27 figures, the full disclosure of which is hereby incorporated by reference, and U.S. Design patent application Ser. No. 29/153,851, entitled “Paint Applicator Handle”, filed on Jan. 11, 2002, by Matthew G. Goulet, the full disclosure of which is hereby incorporated by reference.

FIG. 1 is a perspective view of a paint applicator handle of the present invention;

FIG. 2 is a top plan view thereof, the bottom plan view being a mirror image of the top plan view;

FIG. 3 is a rear elevational view thereof;

FIG. 4 is a front elevational view thereof;

FIG. 5 is a left end elevational view thereof;

FIG. 6 is a right end elevational view thereof;

FIG. 7 is a perspective view of a first alternative embodiment of the paint applicator handle of FIG. 1;

FIG. 8 is a top plan view thereof, the bottom plan view being a mirror image of the top plan view shown;

FIG. 9 is a rear elevational view thereof;

FIG. 10 is a front elevational view thereof;

FIG. 11 is a left end elevational view thereof;

FIG. 12 is a right end elevational view thereof;

FIG. 13 is a perspective view of a second alternative embodiment of the paint applicator handle of FIG. 1;

FIG. 14 is a top plan view thereof, the bottom plan view being a mirror image of the top plan view shown;

FIG. 15 is a rear end elevational view thereof;

FIG. 16 is a front end elevational view thereof;

FIG. 17 is a left end elevational view thereof;

FIG. 18 is a right end elevational view thereof;

FIG. 19 is a perspective view of a third alternative embodiment of the paint applicator handle of FIG. 1;

FIG. 20 is a top plan view thereof;

FIG. 21 is a rear elevational view thereof;

FIG. 22 is a bottom plan view thereof;

FIG. 23 is a front elevational view thereof;

FIG. 24 is a right end elevational view thereof;

FIG. 25 is a left end elevational view thereof;

FIG. 26 is a perspective view of a fourth alternative embodiment of the paint applicator handle of FIG. 1;

FIG. 27 is a top plan view thereof;

FIG. 28 is a rear elevational view thereof;

FIG. 29 is a bottom plan view thereof;

FIG. 30 is a front elevational view thereof;

FIG. 31 is a right end elevational view thereof; and,

FIG. 32 is a left end elevational view thereof.

The broken lines immediately adjacent the shaded portions represent the bounds of the claimed design and all other broken lines are for illustrative purposes only. None of the broken lines form part of the claimed design. The surface shading represents a contrast in color, texture, or materials and does not indicate a specific color or surface characteristic.

1 Claim, 12 Drawing Sheets

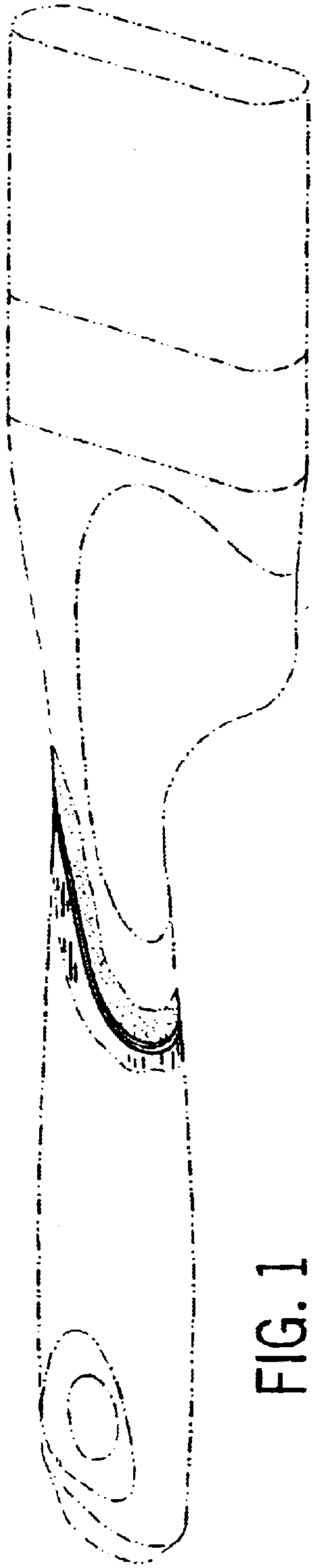

FIG. 1

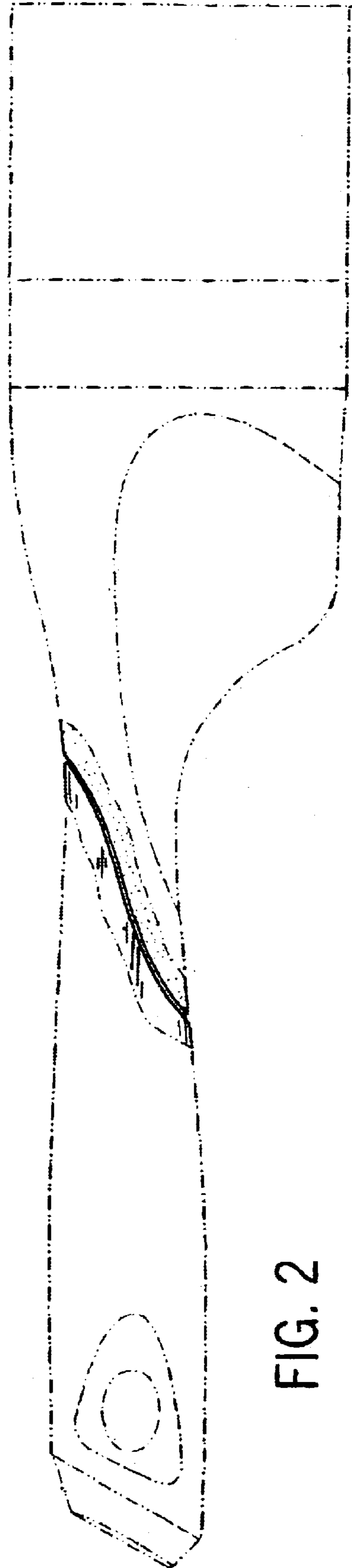

FIG. 2



FIG. 3

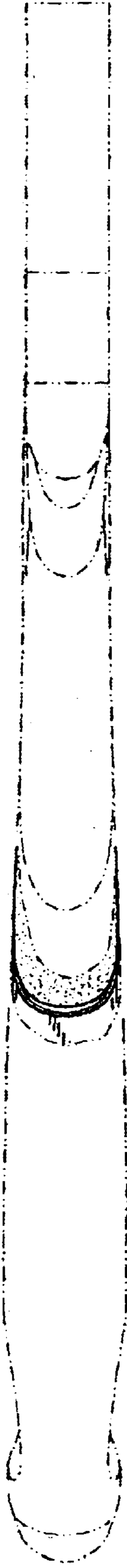

FIG. 4

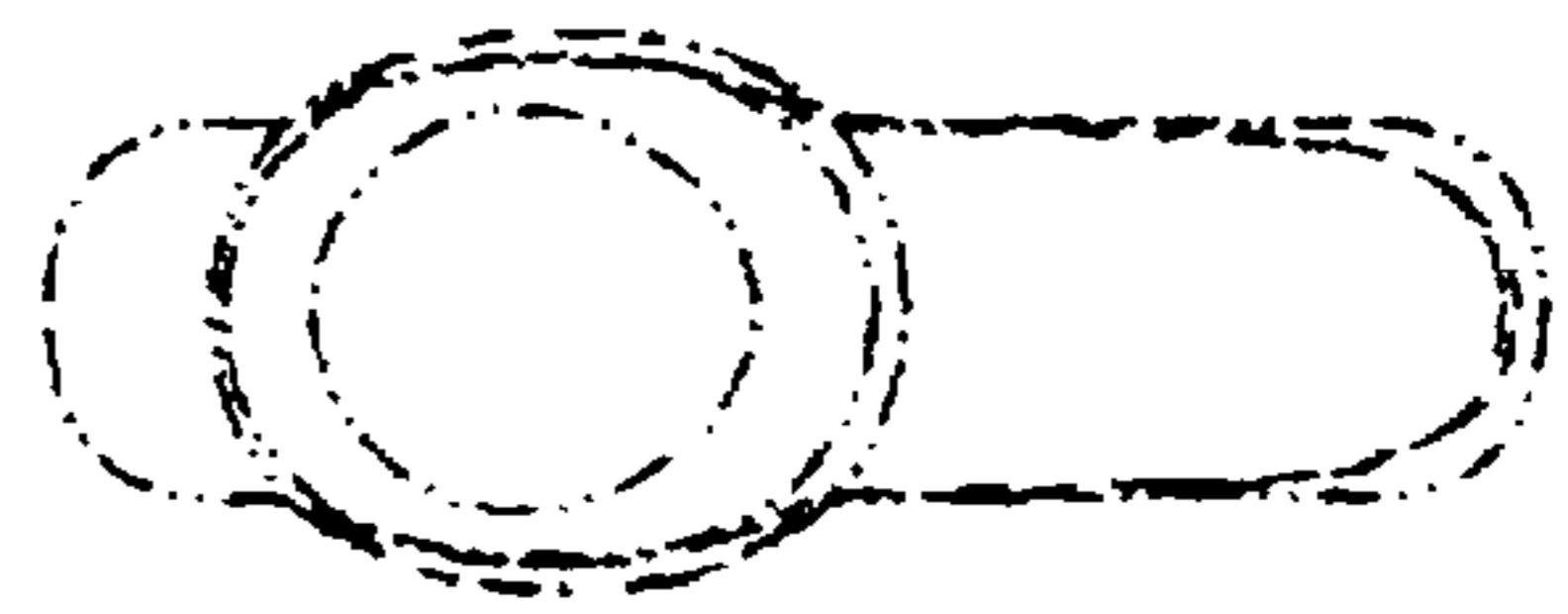

FIG. 5

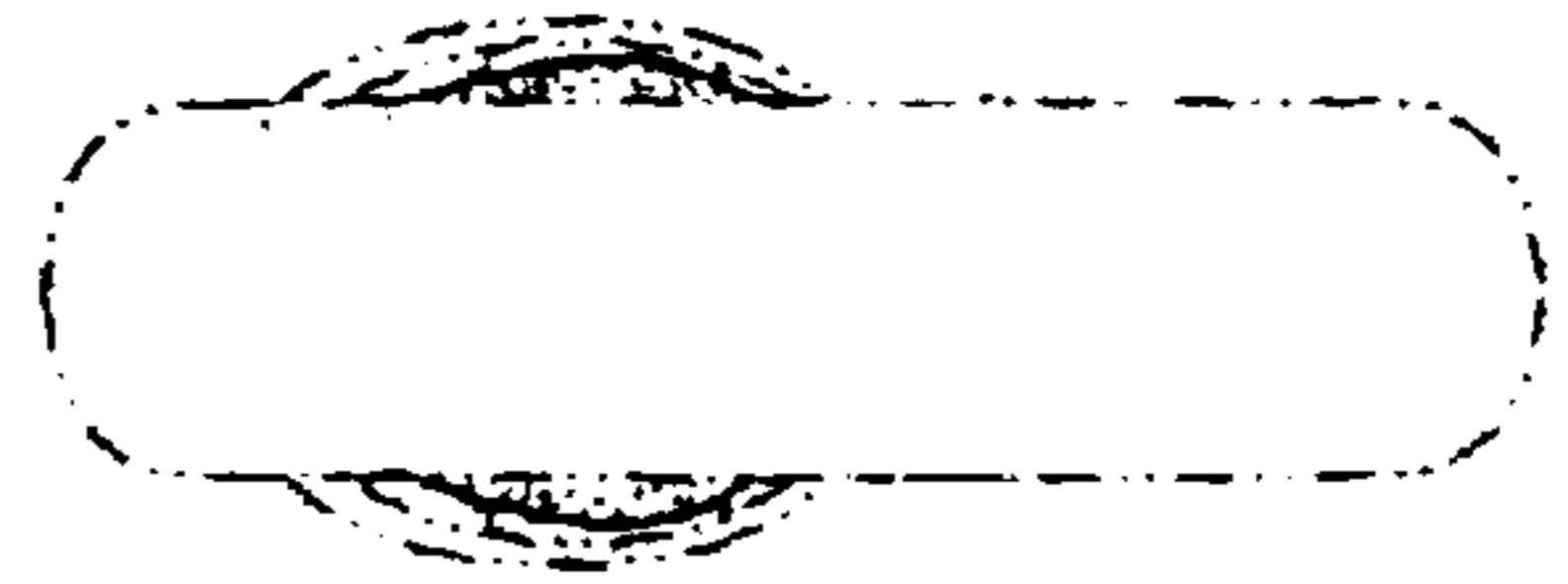

FIG. 6

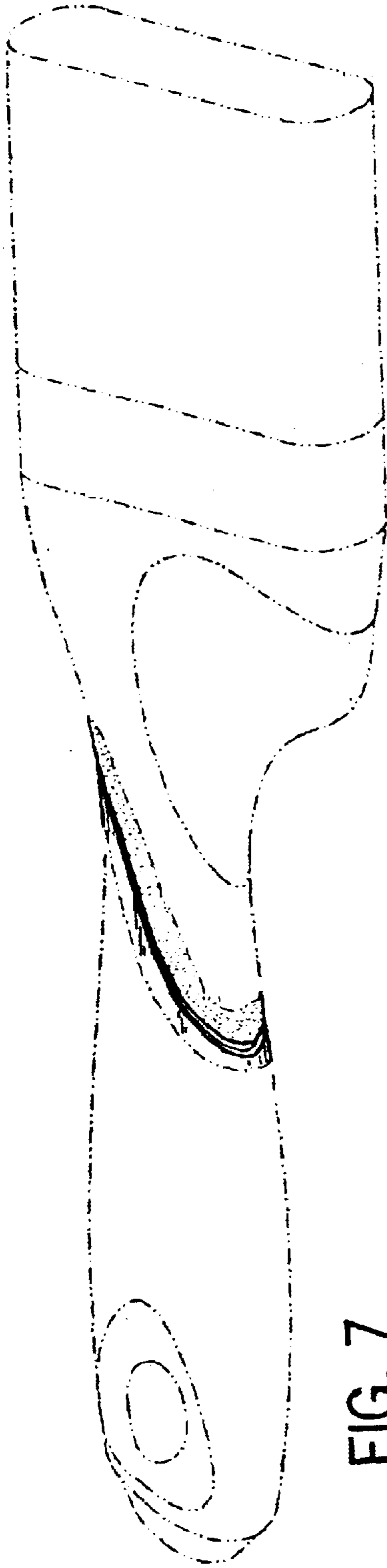

FIG. 7

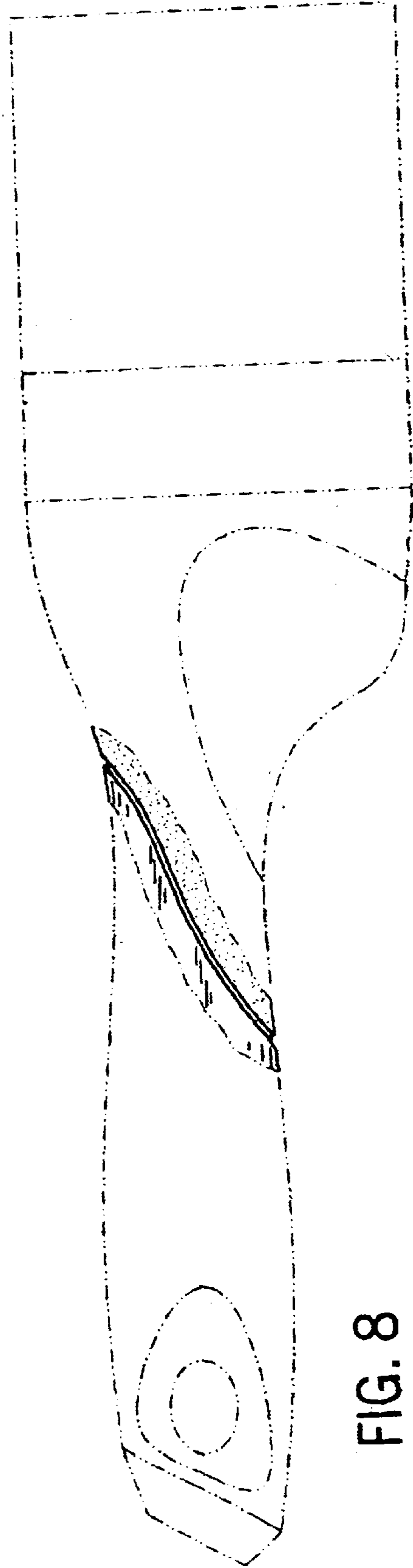

FIG. 8

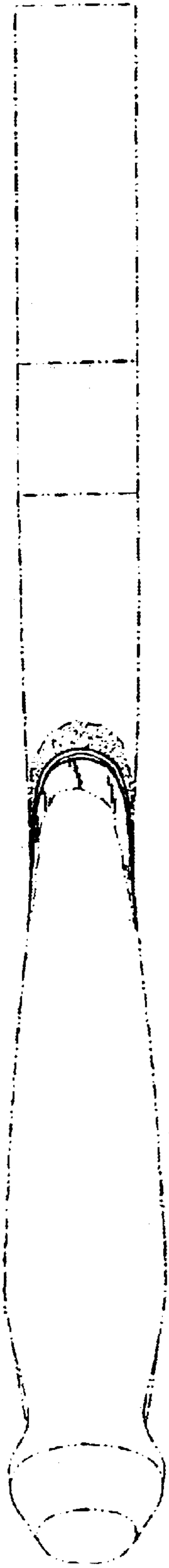

FIG. 9

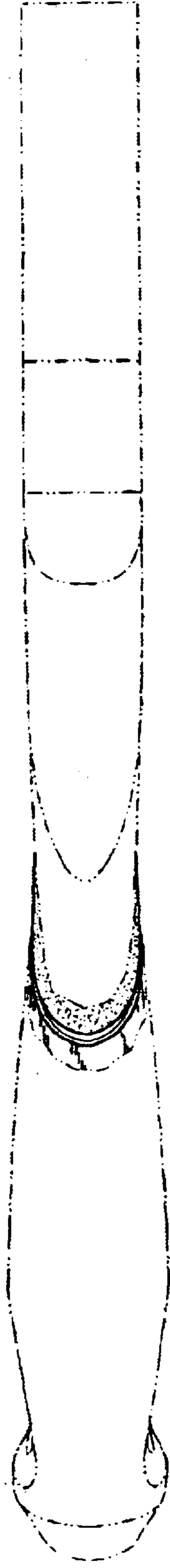

FIG. 10

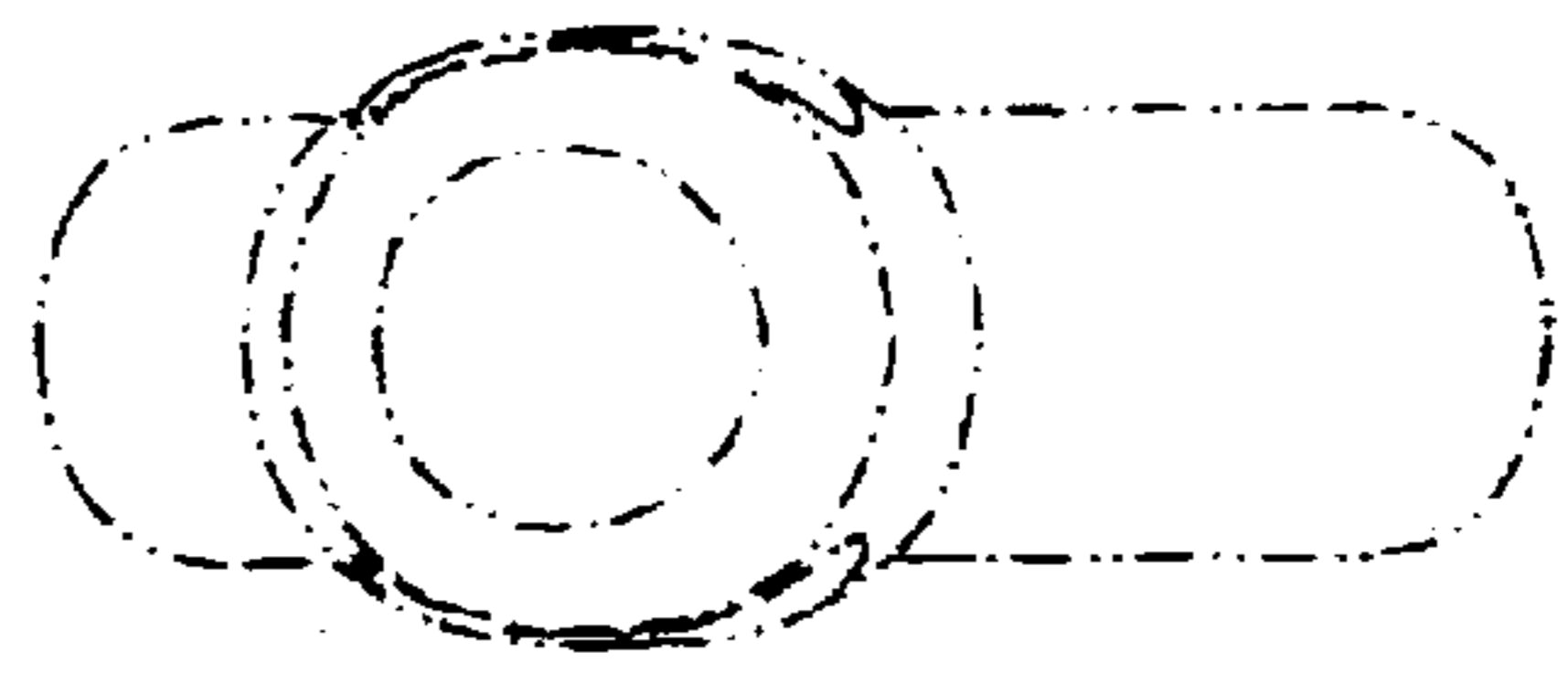

FIG. 11

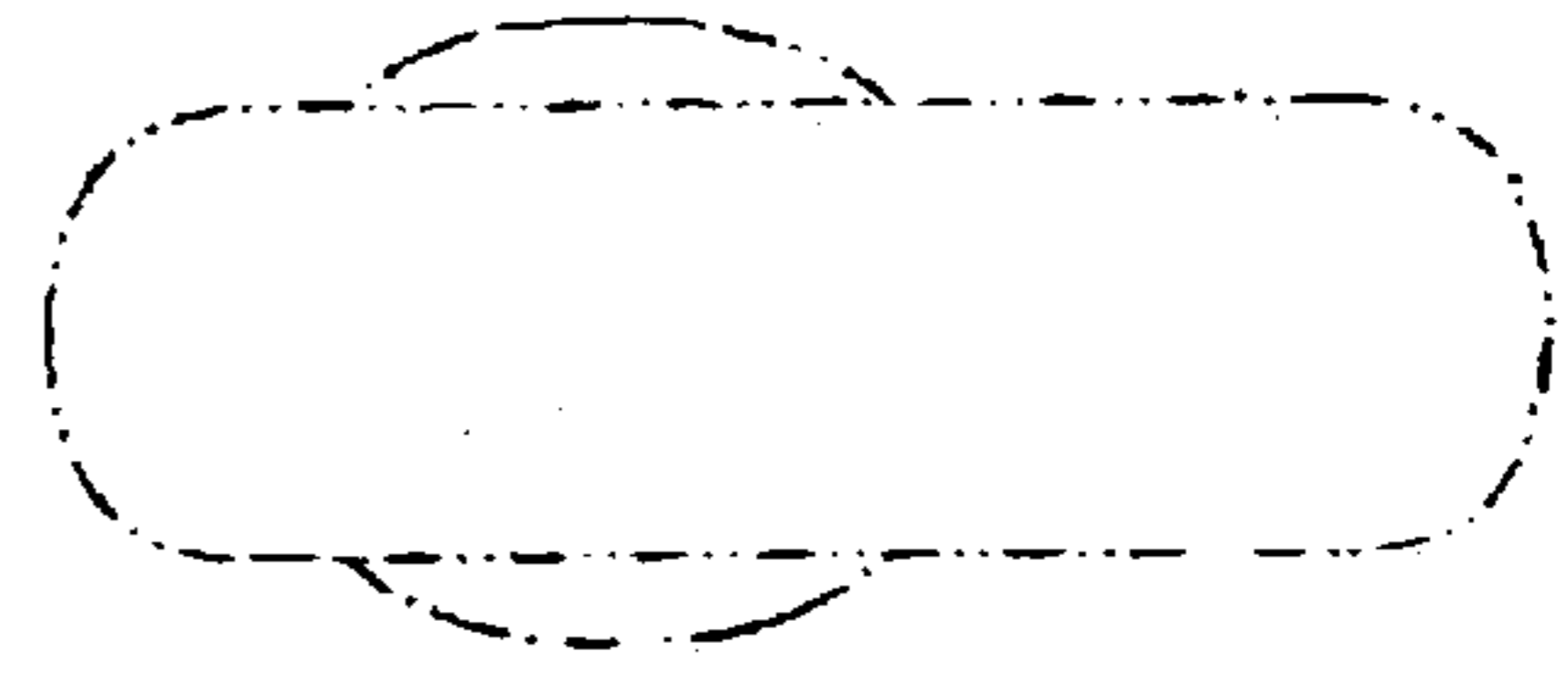

FIG. 12

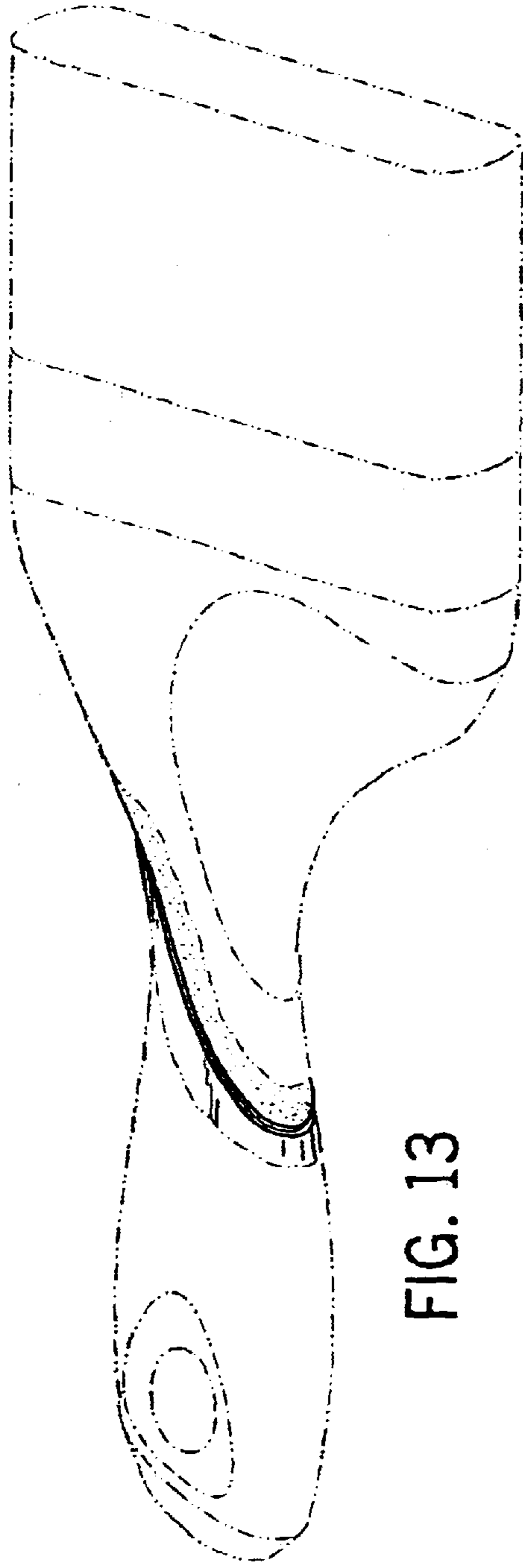

FIG. 13

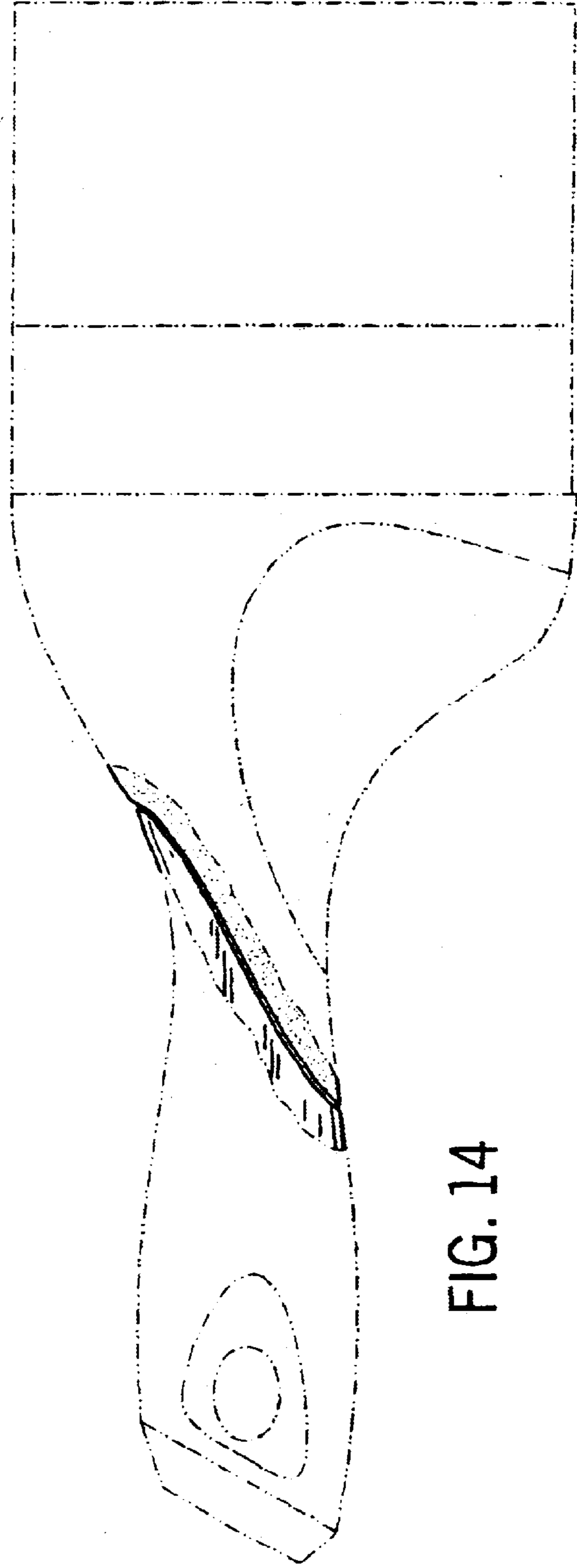

FIG. 14

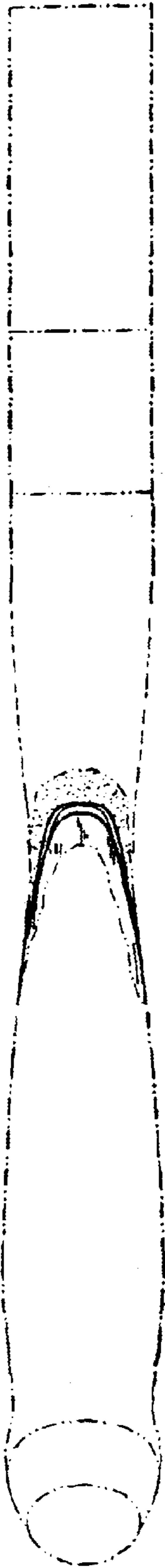

FIG. 15

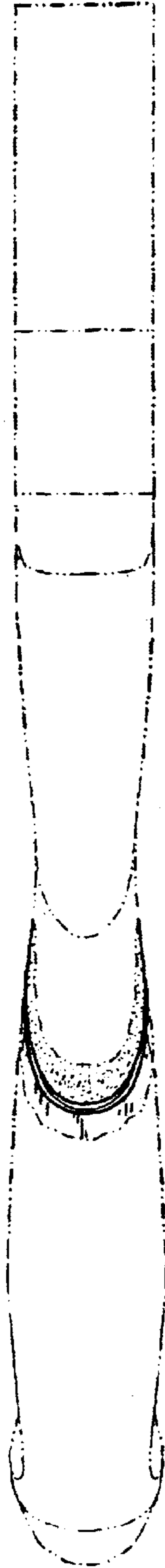

FIG. 16



FIG. 17

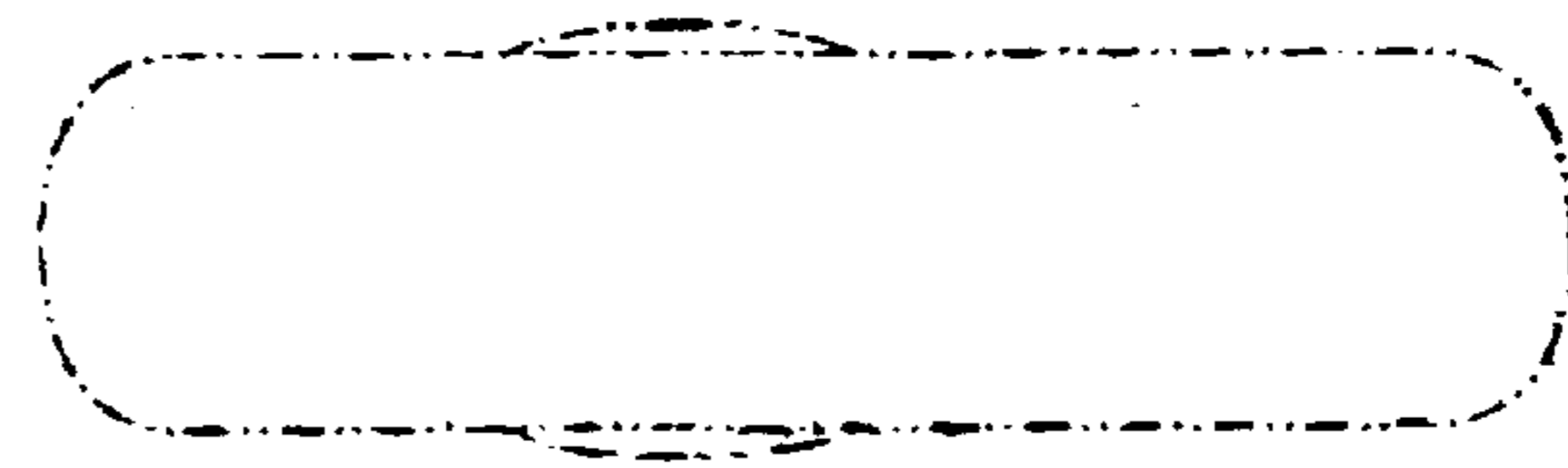

FIG. 18

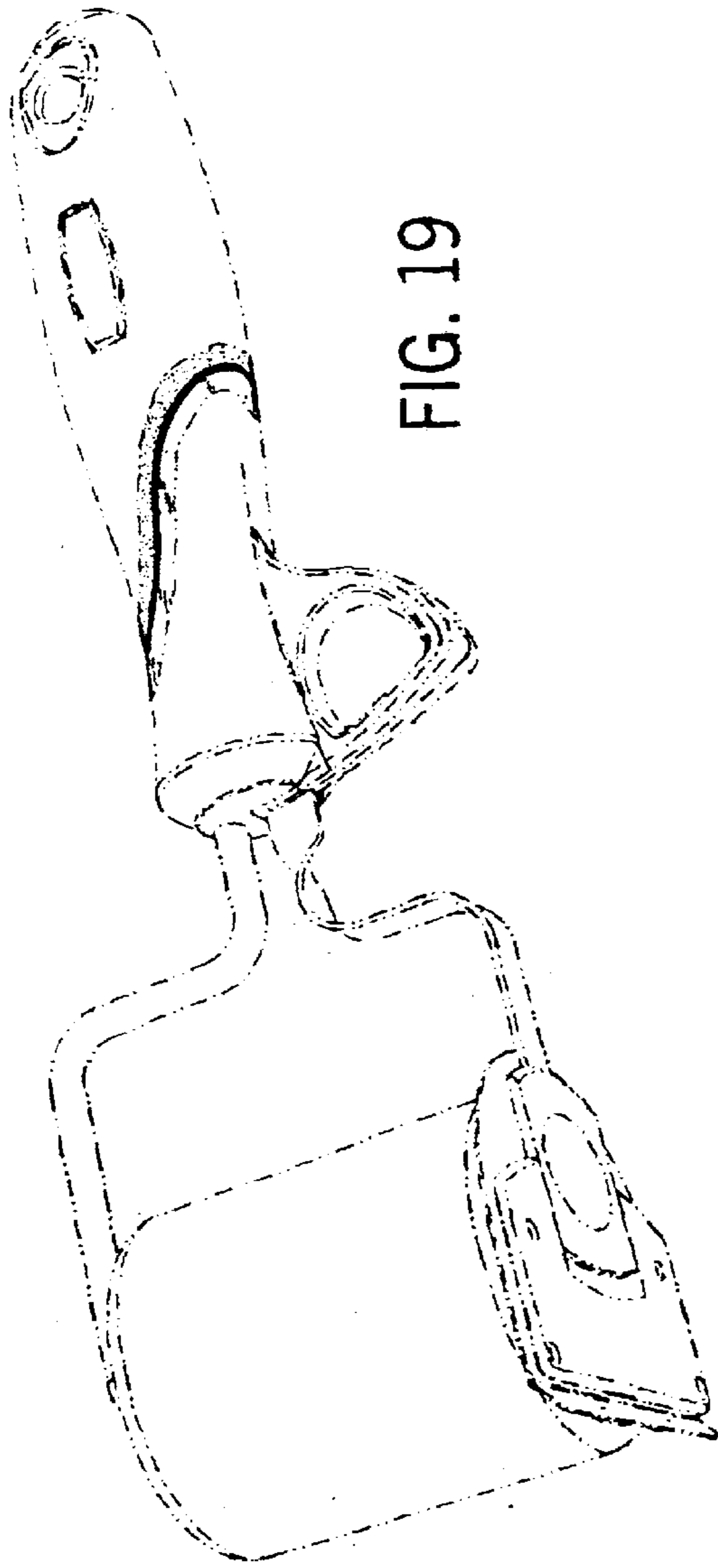

FIG. 19

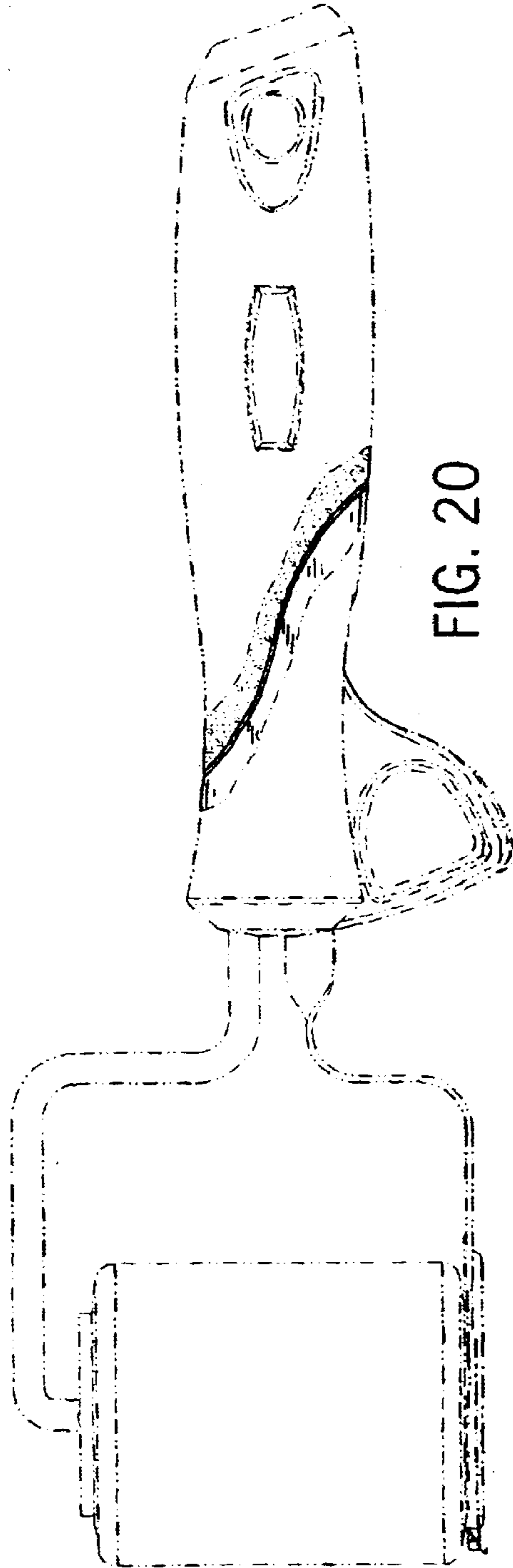

FIG. 20

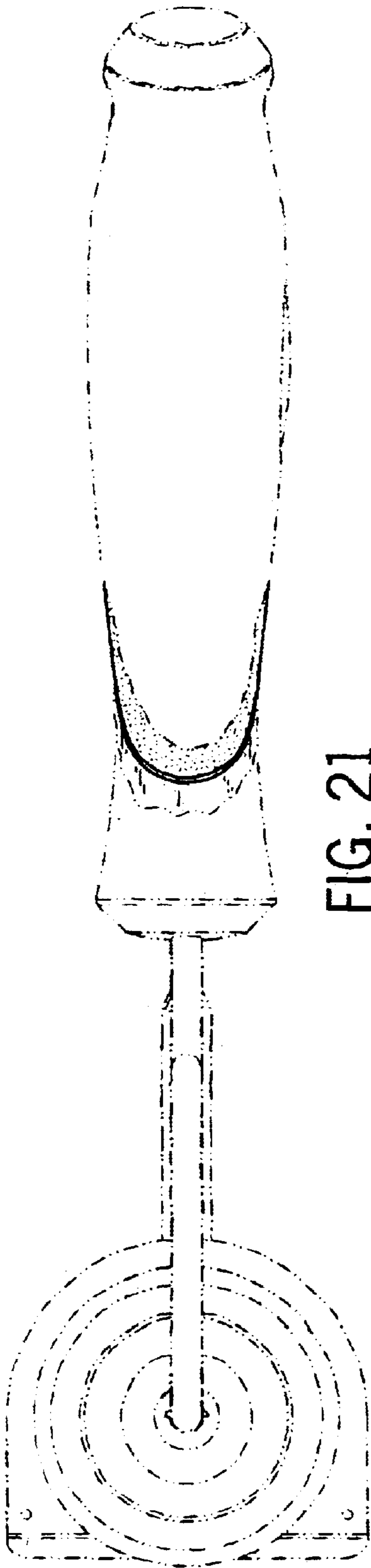

FIG. 21

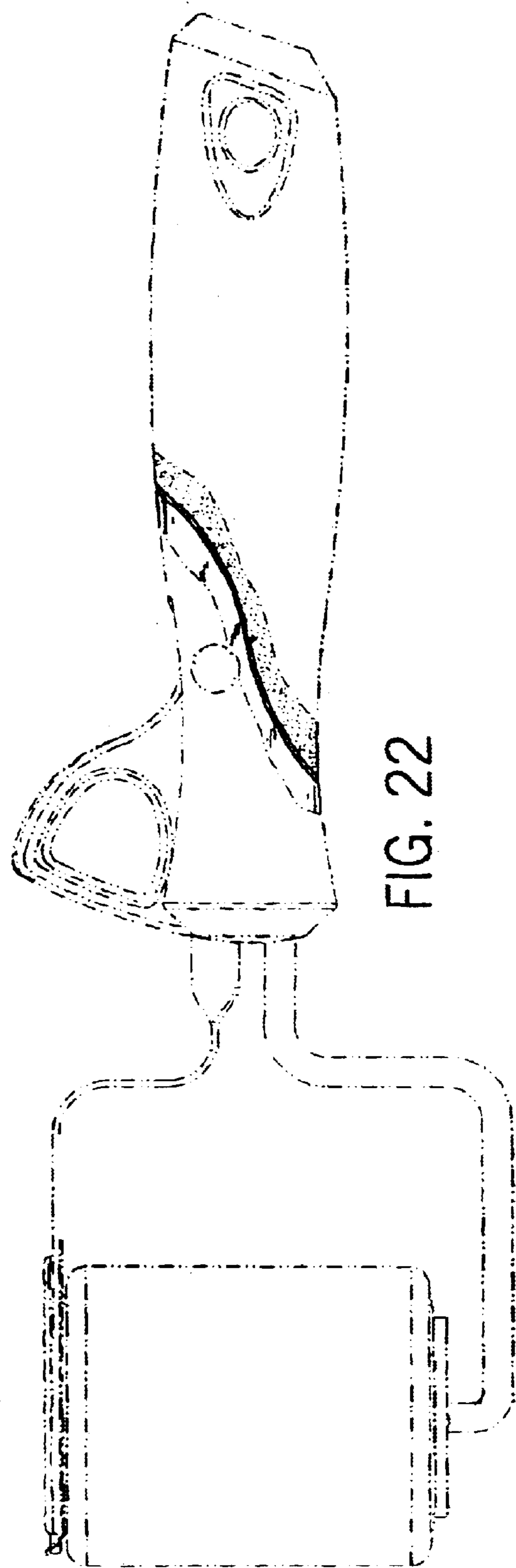

FIG. 22

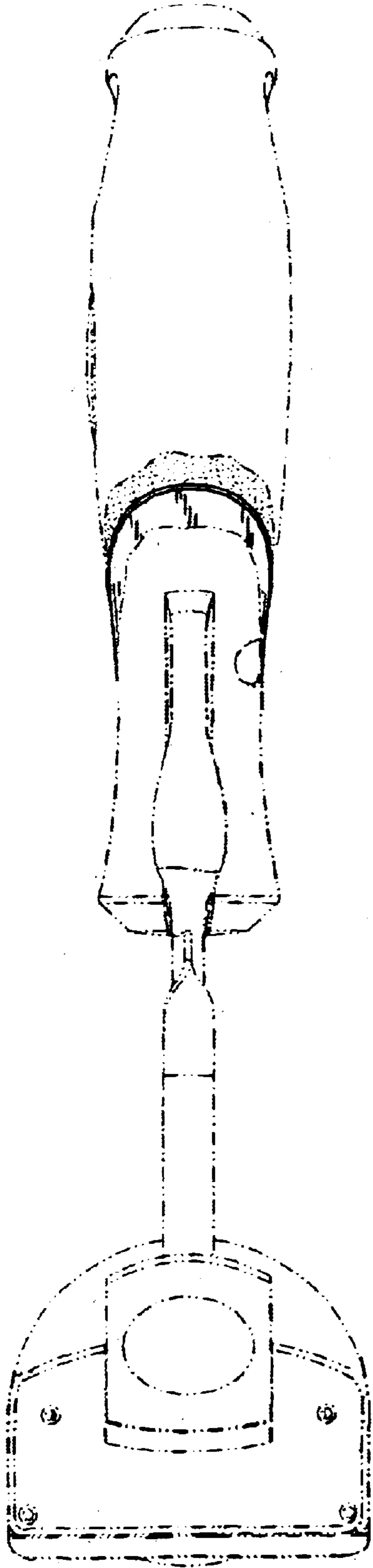

FIG. 23

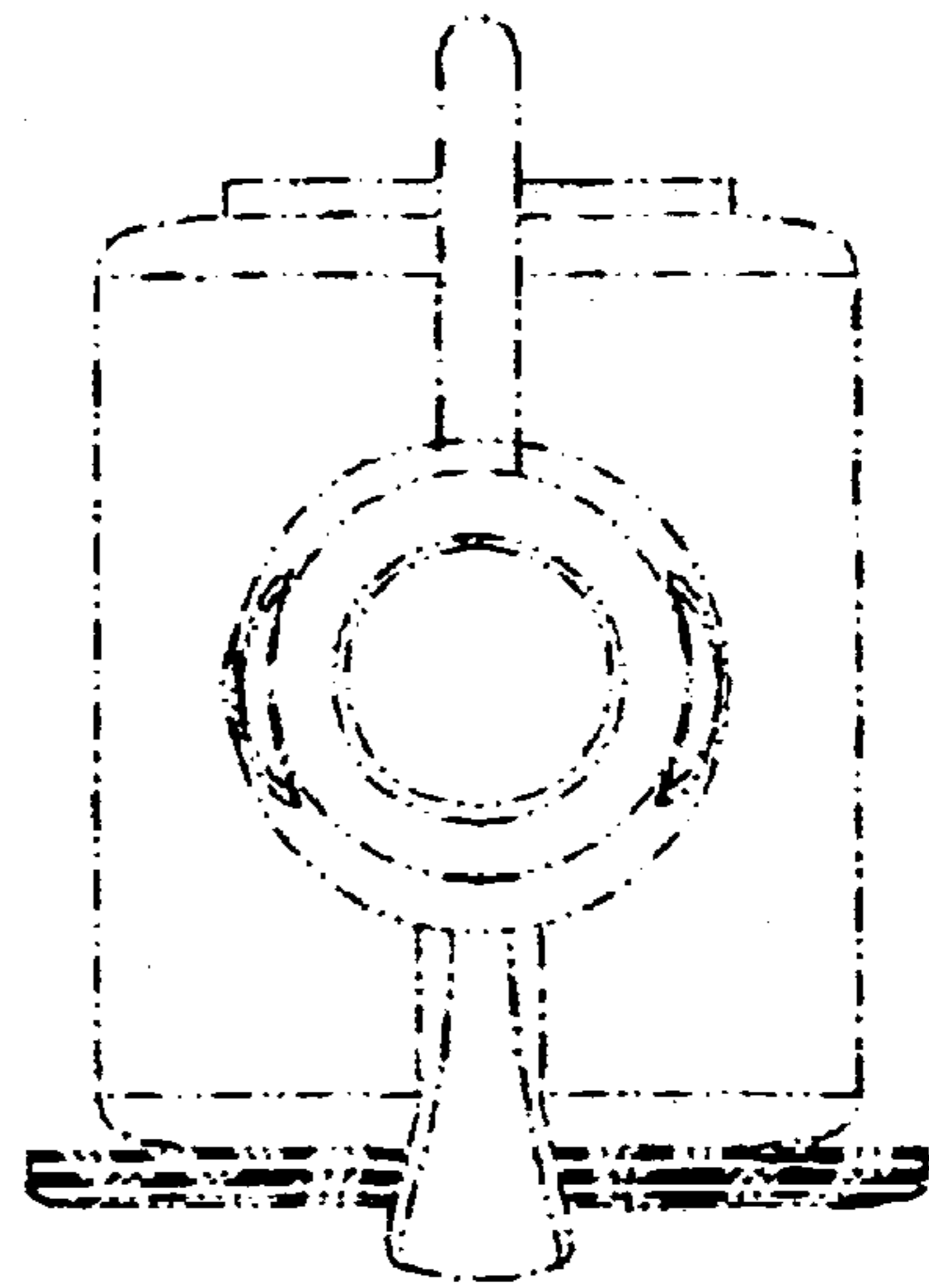

FIG. 24

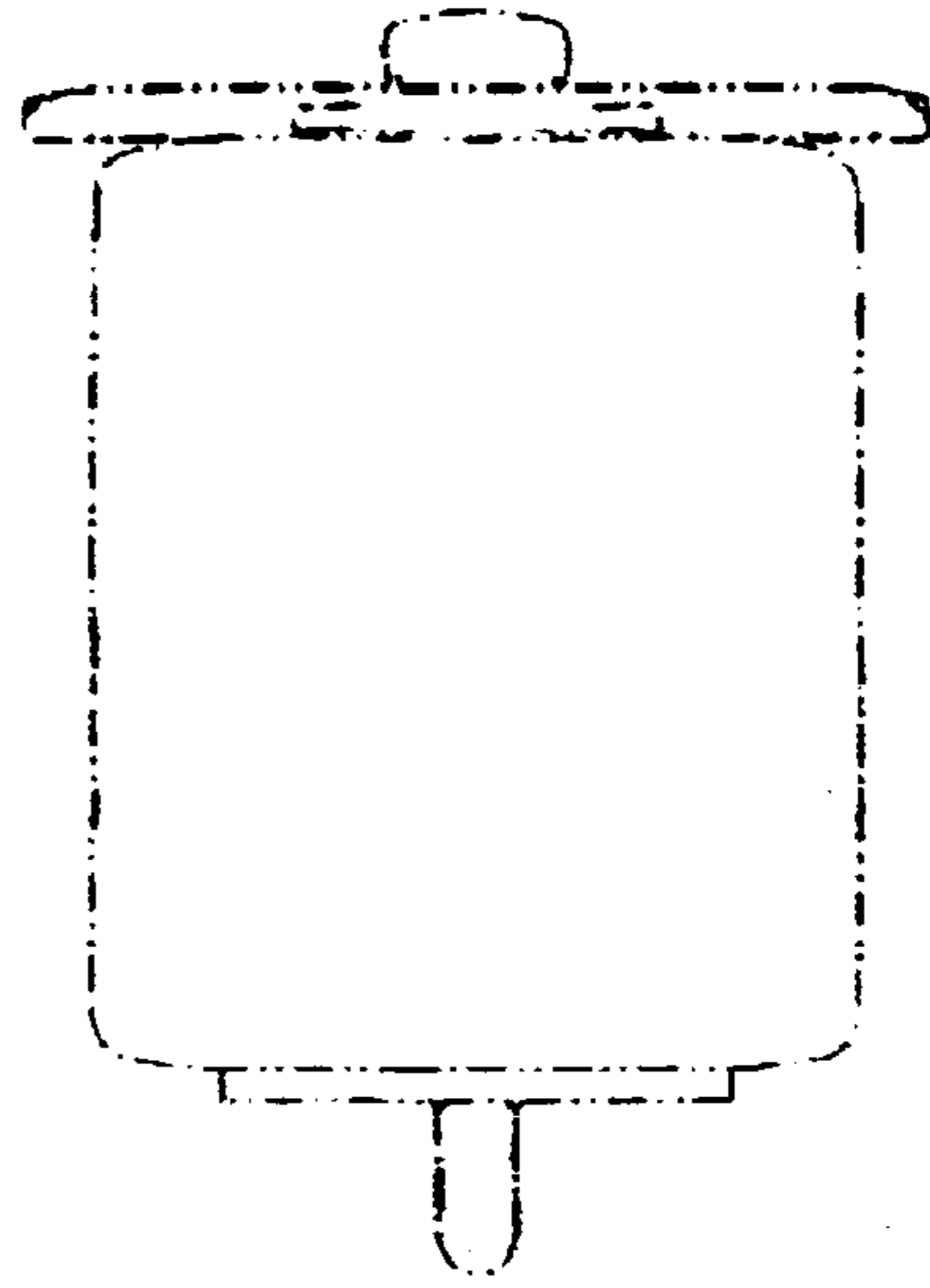

FIG. 25

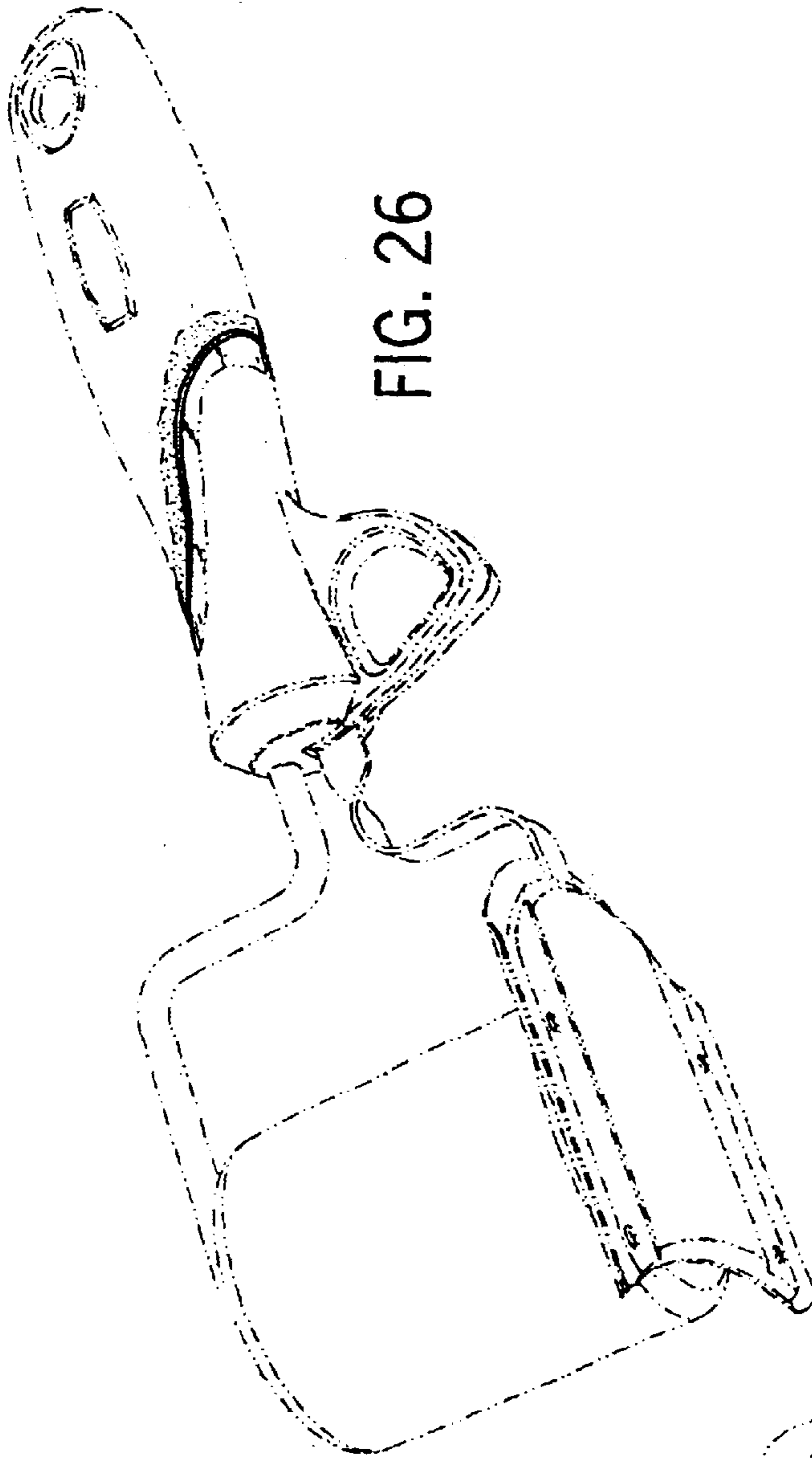

FIG. 26

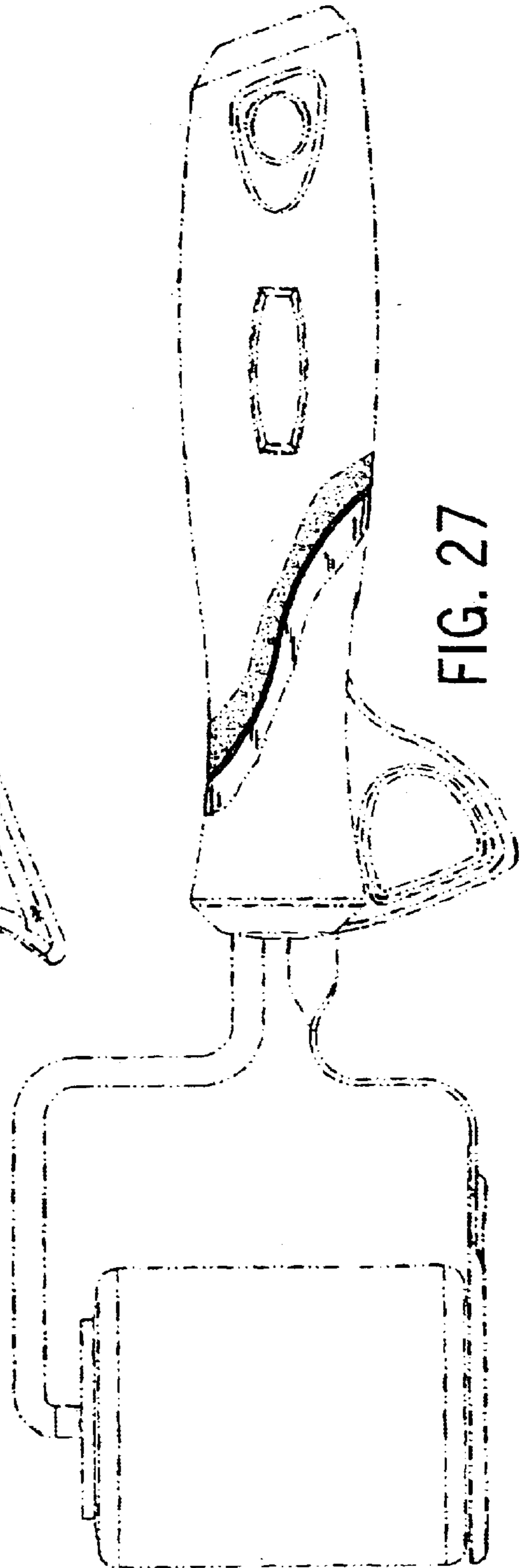

FIG. 27

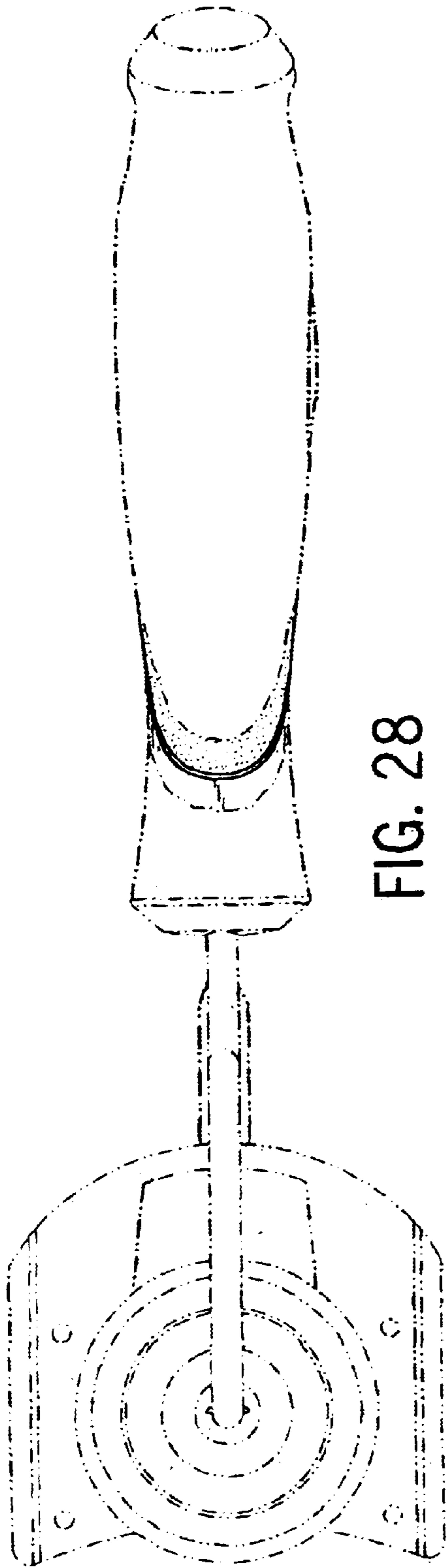

FIG. 28

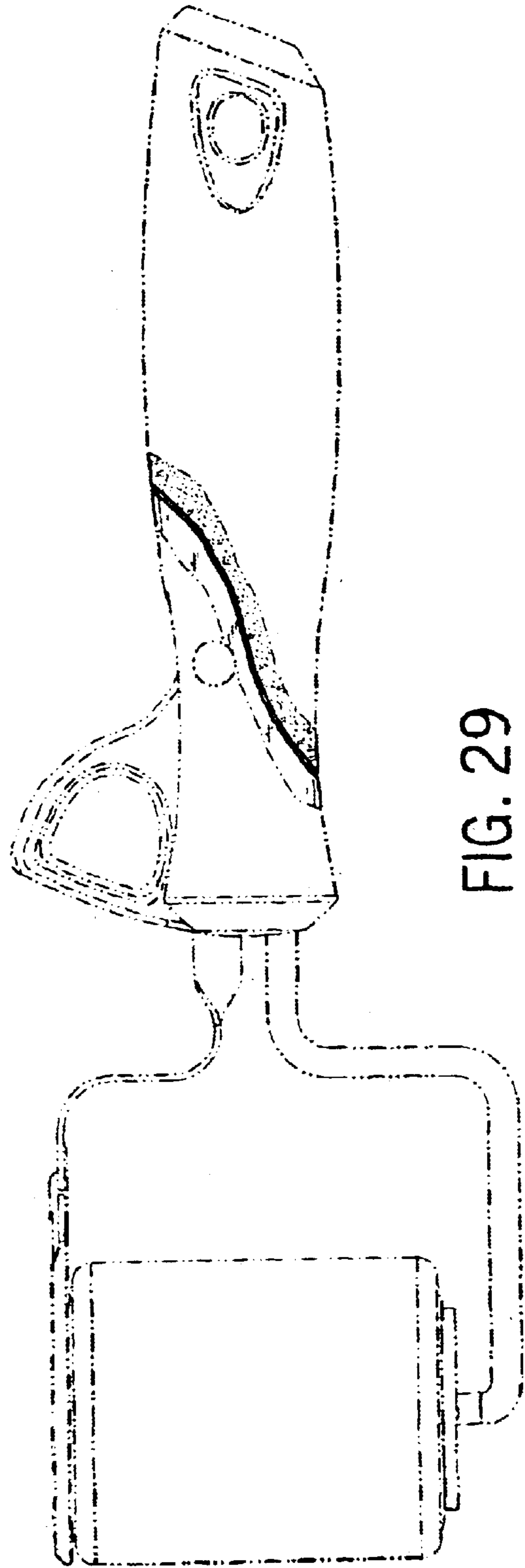

FIG. 29

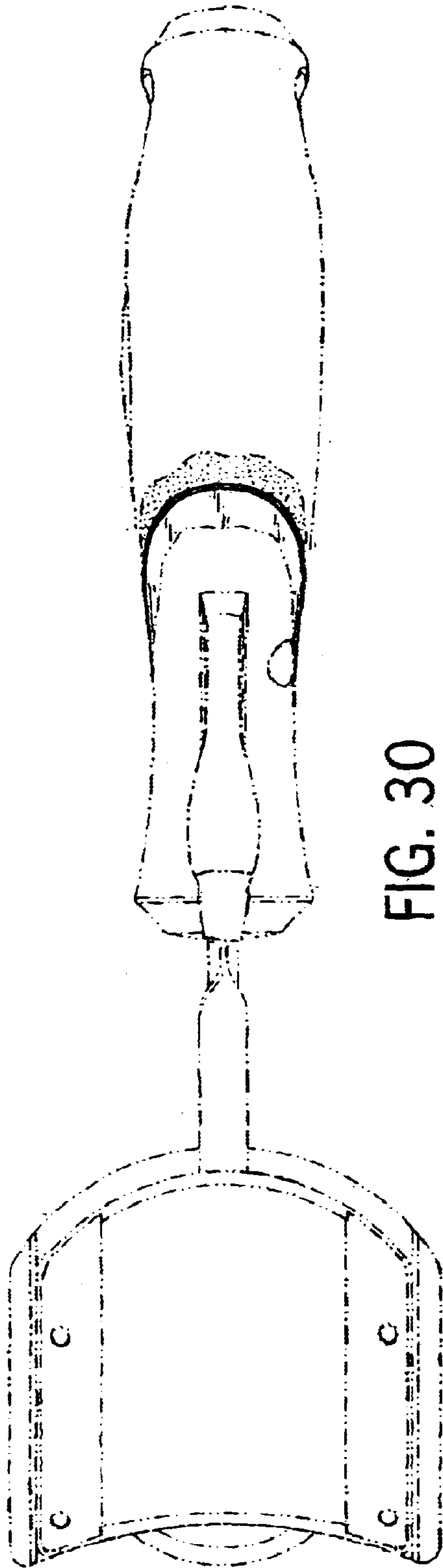

FIG. 30

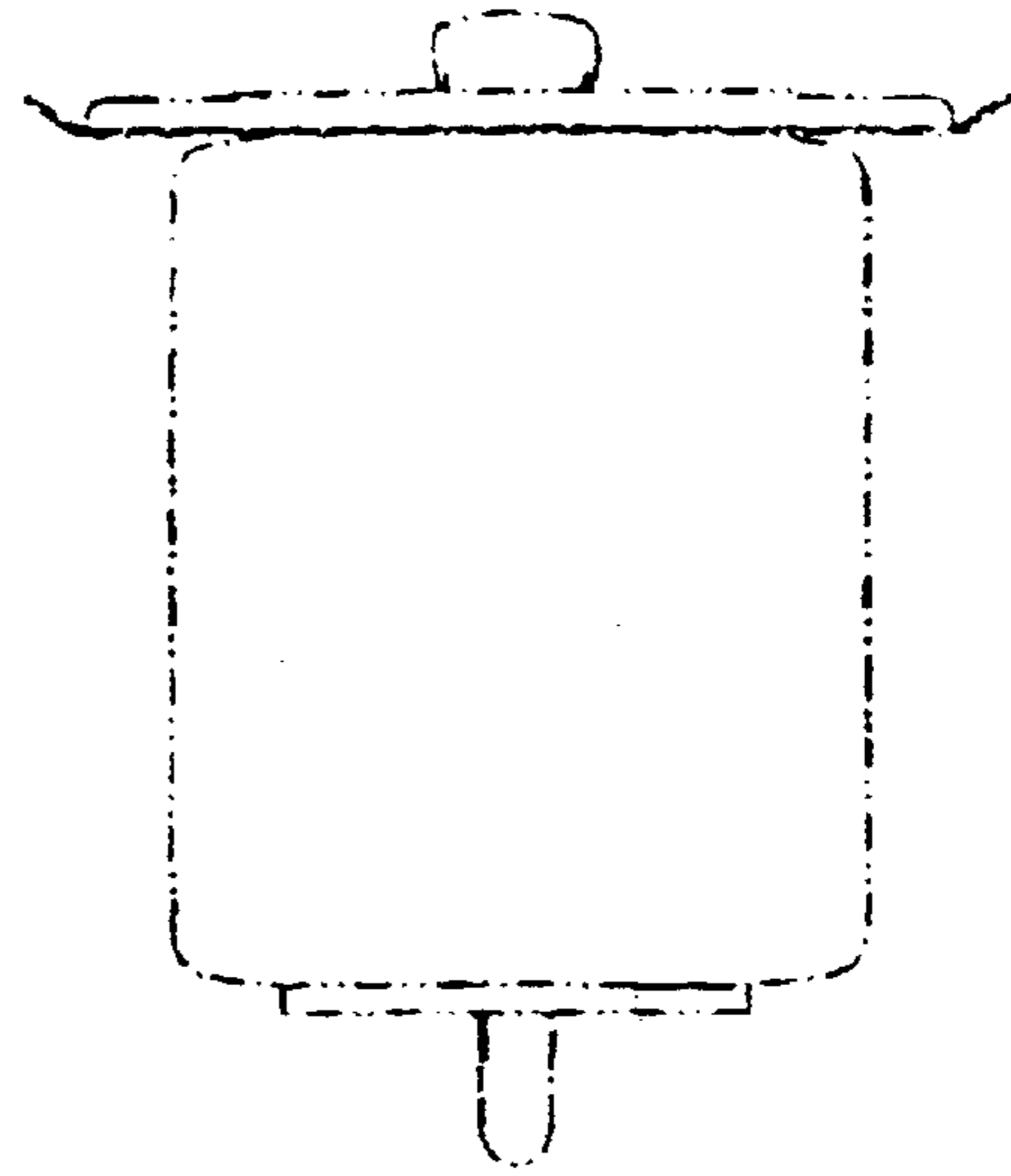

FIG. 32

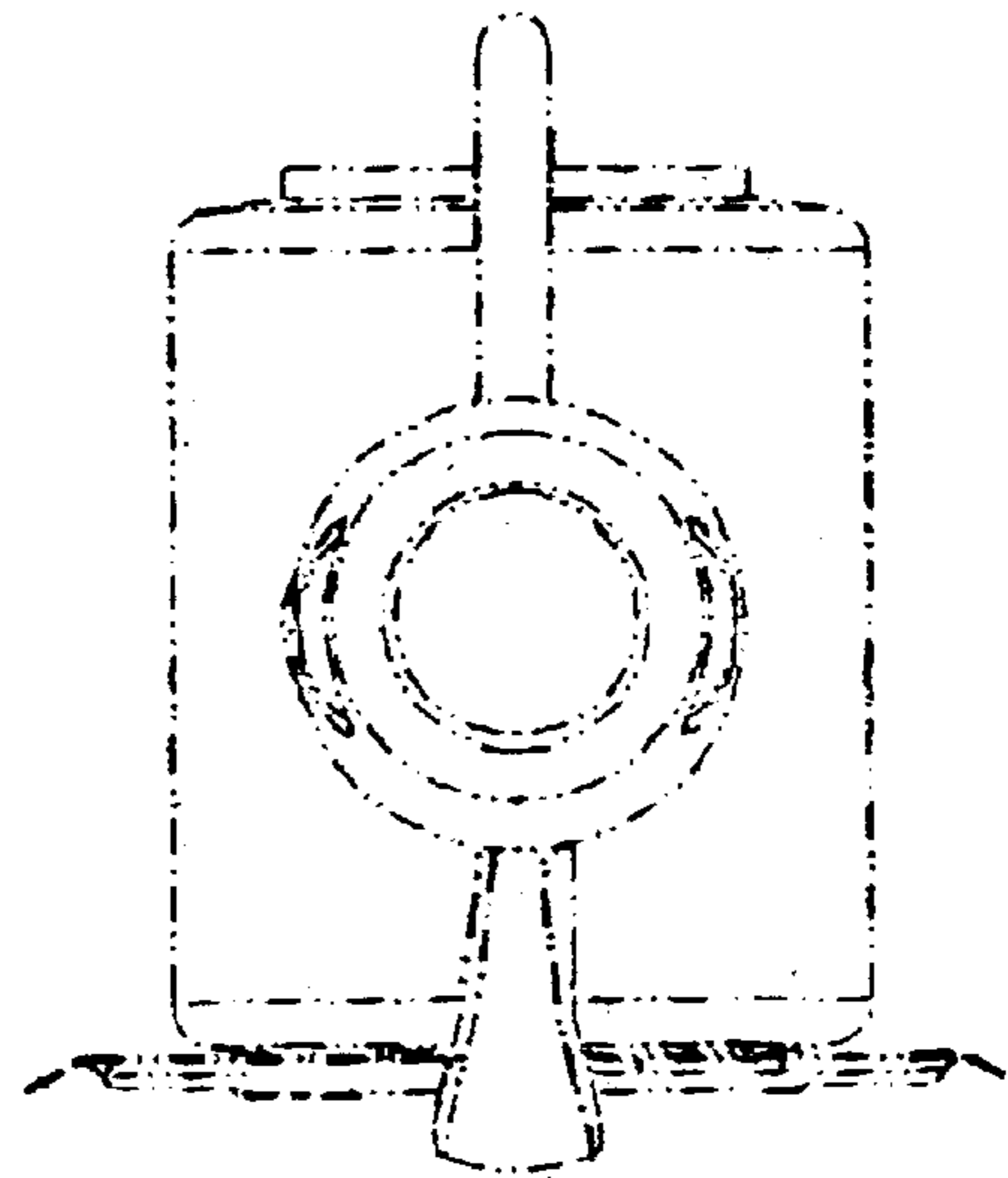

FIG. 31