



US00D482076S

(12) **United States Design Patent**
Tabor

(10) **Patent No.:** **US D482,076 S**

(45) **Date of Patent:** **** Nov. 11, 2003**

(54) **EAGLE KITE**

(76) **Inventor:** **Don Tabor**, 556 Florence St., Imperial Beach, CA (US) 91932

(**) **Term:** **14 Years**

(21) **Appl. No.:** **29/167,150**

(22) **Filed:** **Sep. 9, 2002**

(51) **LOC (7) Cl.** **21-01**

(52) **U.S. Cl.** **D21/438; D21/445; D21/449**

(58) **Field of Search** **D21/436, 438, D21/439, 445, 447-449, 606; 446/34-68, 228, 230, 487, 488, 490; 244/153 R, 154**

(56) **References Cited**

U.S. PATENT DOCUMENTS

D55,732 S	*	7/1920	Van Shrum	D21/449
1,762,051 A	*	6/1930	Cooney	446/228 X
D151,944 S	*	11/1948	Shackelford	D21/445
2,475,976 A	*	7/1949	McCoy	244/154
3,076,626 A	*	2/1963	Andrews	244/154
D196,057 S	*	8/1963	Levine	D21/438
3,347,500 A	*	10/1967	Hartig	244/154
D226,718 S	*	4/1973	McAllister	D21/438
3,871,126 A	*	3/1975	Miller	446/32

3,945,147 A	*	3/1976	Crowder	446/61
3,951,363 A	*	4/1976	Grael	244/153 R
5,727,756 A	*	3/1998	Rowe	244/153 R
6,139,392 A	*	10/2000	Walker et al.	446/61

* cited by examiner

Primary Examiner—Ted Shooman

Assistant Examiner—C. Tuttle

(74) *Attorney, Agent, or Firm*—Cislo & Thomas LLP

(57) **CLAIM**

The ornamental design for a eagle kite, as shown and described herein.

DESCRIPTION

FIG. 1. Is a perspective view of my eagle kit design;

FIG. 2. Is a top view thereof

FIG. 3. Is a bottom view thereof;

FIG. 4. Is a front view thereof;

FIG. 5. Is a rear view thereof; and,

FIG. 6. Is a right side view thereof, the left side view being identical thereto.

The structures shown in broken lines are for illustrative purposes only and form no part of the claimed design.

1 Claim, 5 Drawing Sheets

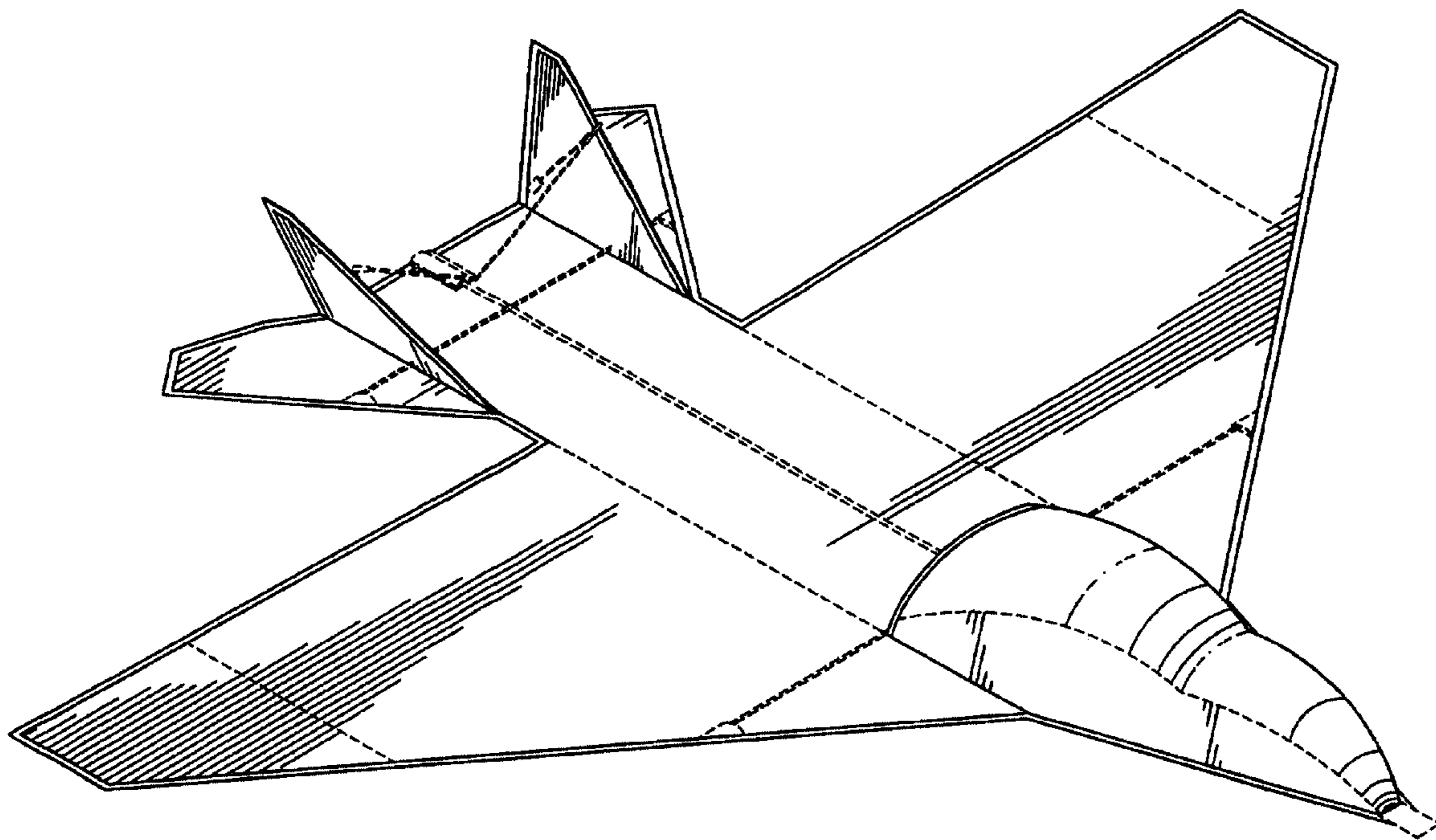

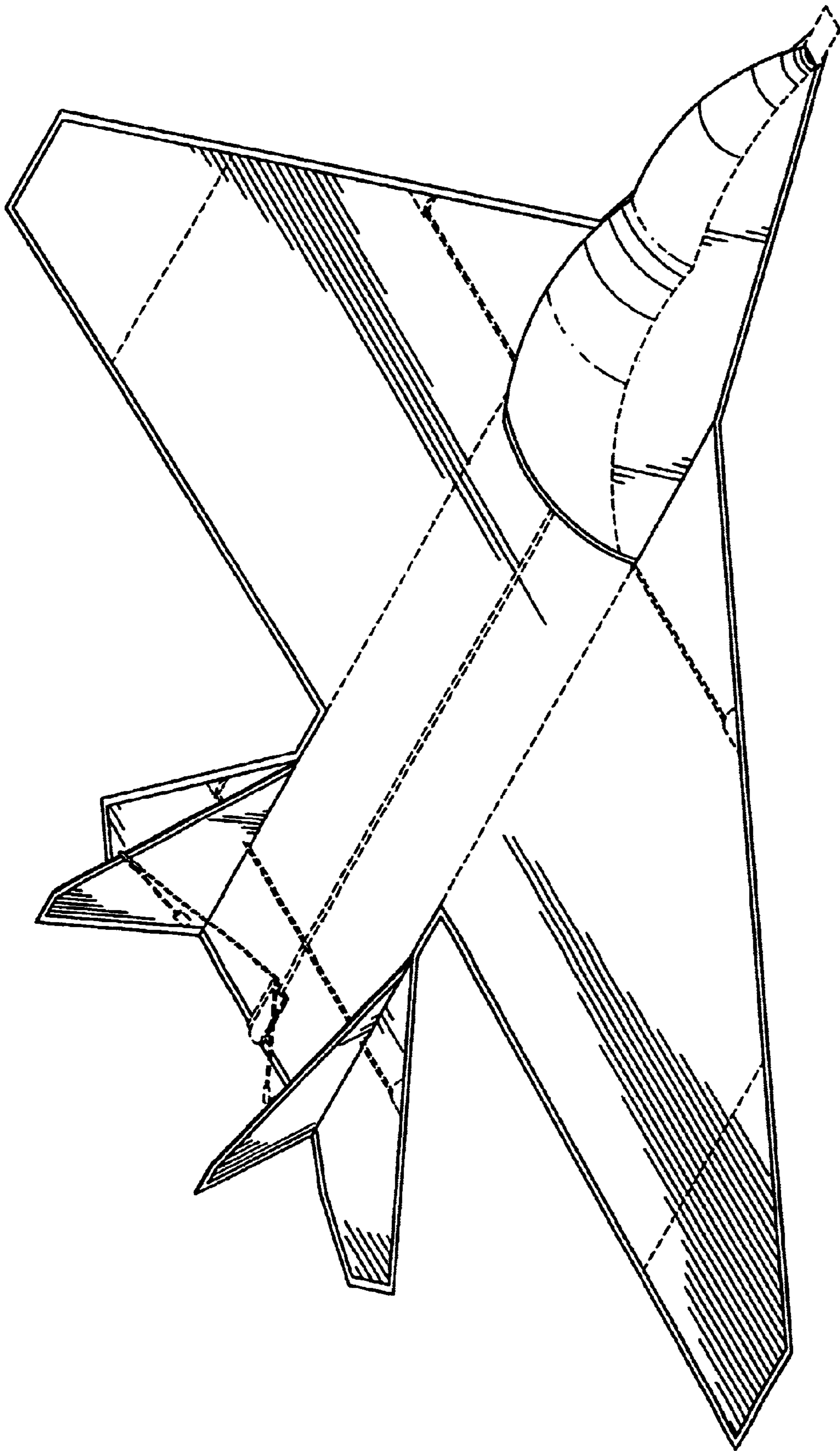

FIG. 1

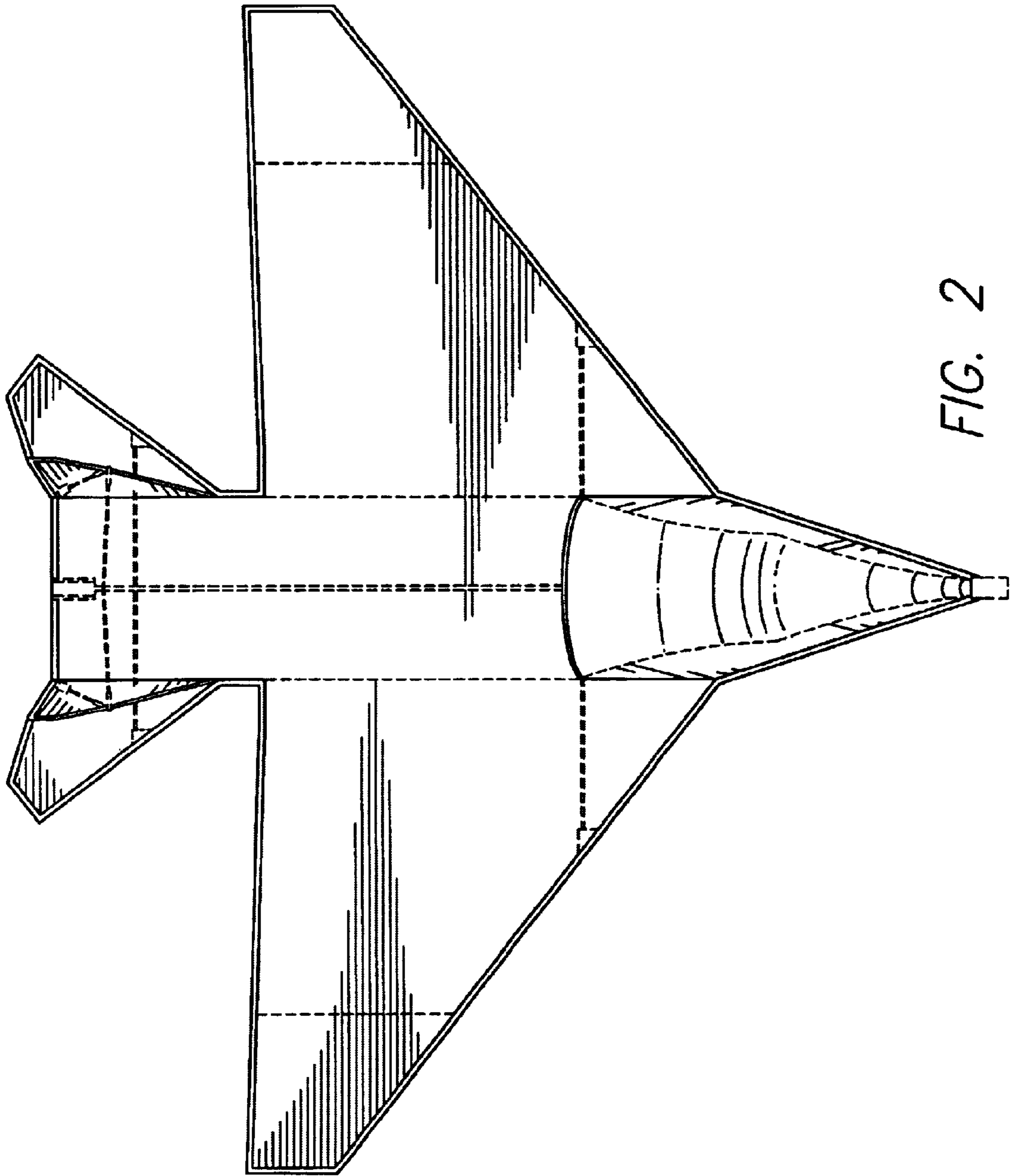

FIG. 2

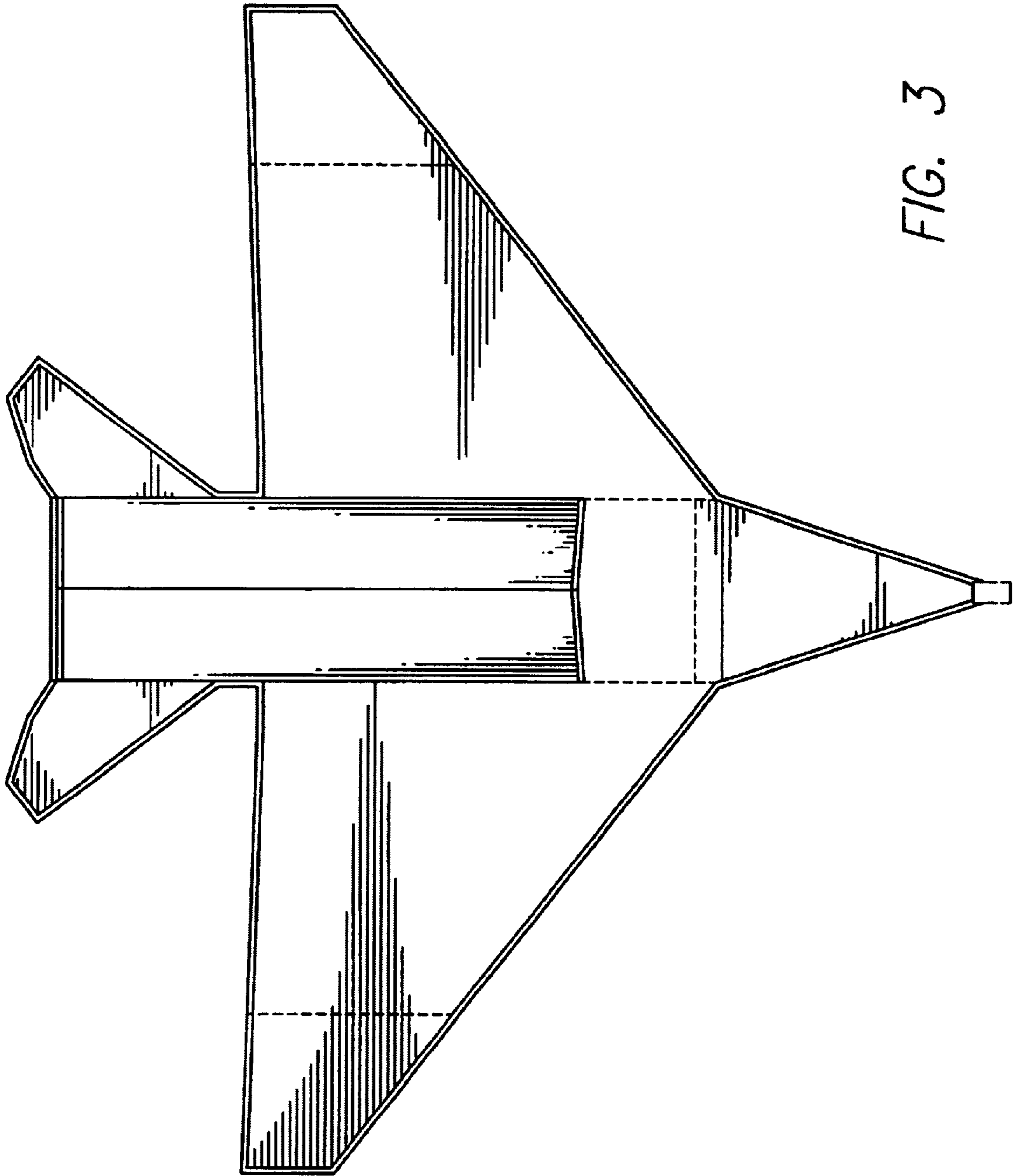

FIG. 3

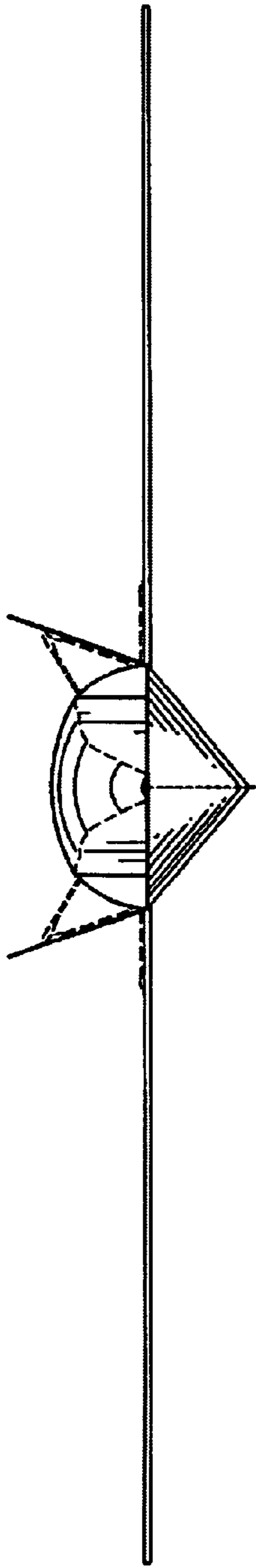

FIG. 4

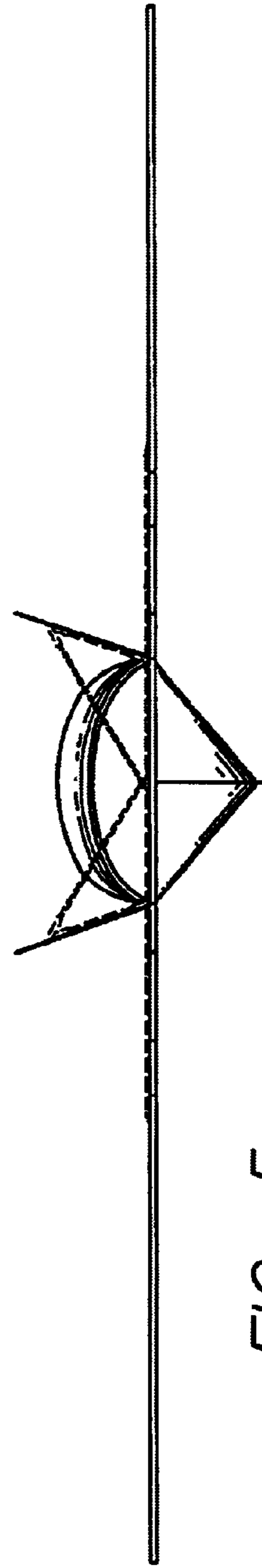

FIG. 5

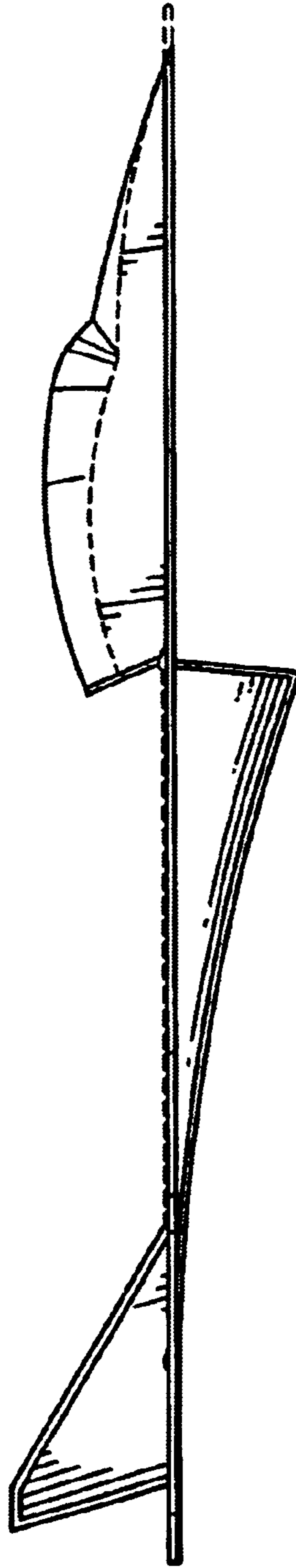

FIG. 6