



US00D481980S

(12) **United States Design Patent**  
**Song**

(10) **Patent No.:** **US D481,980 S**

(45) **Date of Patent:** **\*\* Nov. 11, 2003**

(54) **MOTORCYCLE REAR FENDER**

(75) Inventor: **Michael M. Song**, Maple Grove, MN (US)

(73) Assignee: **Polaris Industries Inc.**, Medina, MN (US)

(\*\*) Term: **14 Years**

(21) Appl. No.: **29/167,053**

(22) Filed: **Sep. 9, 2002**

(51) **LOC (7) Cl.** ..... **12-16**

(52) **U.S. Cl.** ..... **D12/186**

(58) **Field of Search** ..... D12/110, 114,  
D12/184-186; 180/219; D26/28-36; 362/473,  
497, 506; 280/152.1-152.3, 852, 160.1;  
293/102-105

(56) **References Cited**

**U.S. PATENT DOCUMENTS**

D102,374 S	*	12/1936	Kraeft	.....	D12/186
D102,375 S	*	12/1936	Kraeft	.....	D12/186
D104,507 S	*	5/1937	Pawsat	.....	D12/186
D118,828 S	*	2/1940	Morgan	.....	D12/186 X
D215,571 S	*	10/1969	Golden	.....	D12/186
D241,422 S	*	9/1976	Petty et al.	.....	D12/186
D409,774 S	*	5/1999	Hanlon et al.	.....	D26/28
D463,341 S	*	9/2002	Crookes et al.	.....	D12/186

\* cited by examiner

*Primary Examiner*—Alan P. Douglas

*Assistant Examiner*—Linda Brooks

(74) *Attorney, Agent, or Firm*—Fredrikson & Byron, PA

(57) **CLAIM**

I claim the ornamental design for a motorcycle rear fender, as shown and described.

**DESCRIPTION**

FIG. 1 is a side view of the motorcycle rear fender of my design shown in its ordinary environment, mounted on a motorcycle;

FIG. 2 is an enlarged side and rear perspective view of the motorcycle rear fender of my design taken from the side opposite that shown in FIG. 1;

FIG. 3 is an enlarged side view thereof taken from the same side shown in FIG. 1, the opposite side being a mirror image;

FIG. 4 is a front view thereof;

FIG. 5 is a rear view thereof;

FIG. 6 is a top view thereof;

FIG. 7 is a bottom view thereof;

FIG. 8 is a side view of an alternate embodiment of the motorcycle rear fender of my design shown in its ordinary environment, mounted on a motorcycle;

FIG. 9 is an enlarged side and rear perspective view of the alternate embodiment of the motorcycle rear fender of my design taken from the side opposite that shown in FIG. 8;

FIG. 10 is an enlarged side view thereof taken from the same side shown in FIG. 8, the opposite side being a mirror image;

FIG. 11 is a front view thereof;

FIG. 12 is a rear view thereof;

FIG. 13 is a top view thereof; and,

FIG. 14 is a bottom view thereof.

Where included, broken lines showing environment or structure are for illustrative purposes only and form no part of the claimed design.

**1 Claim, 12 Drawing Sheets**

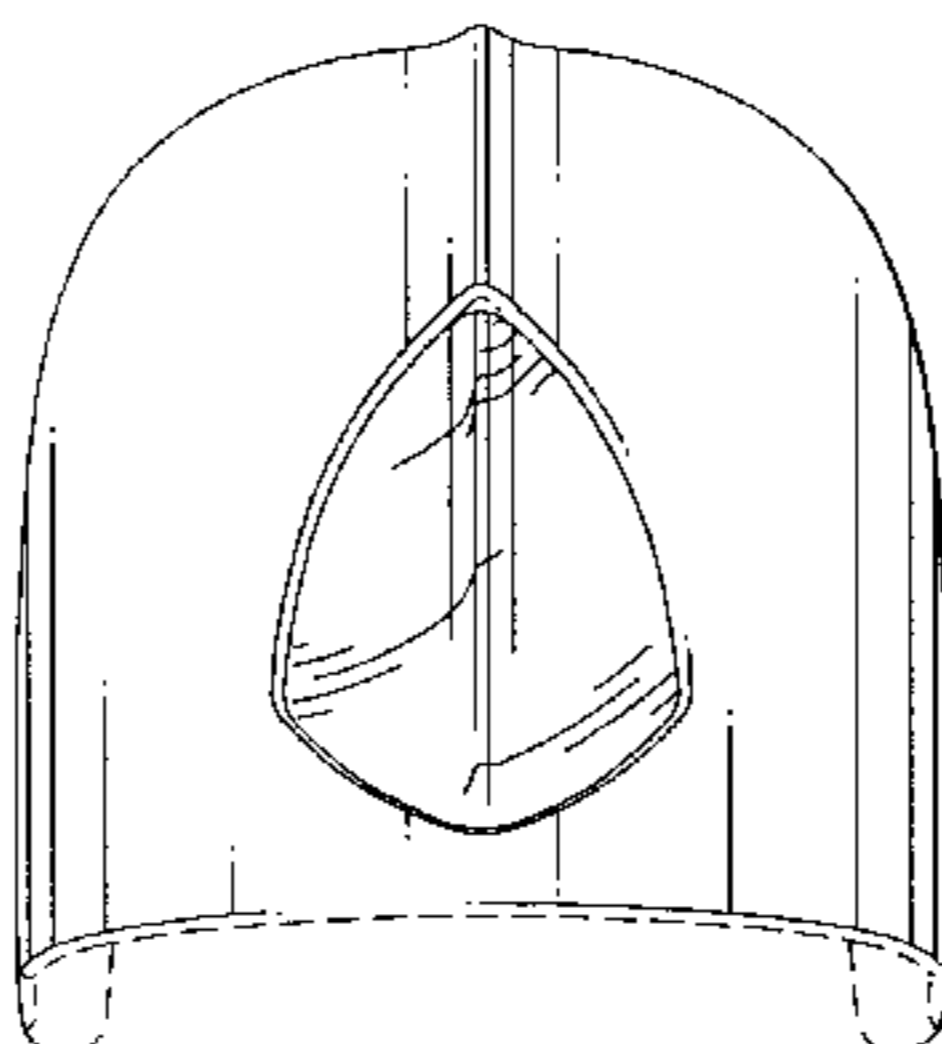
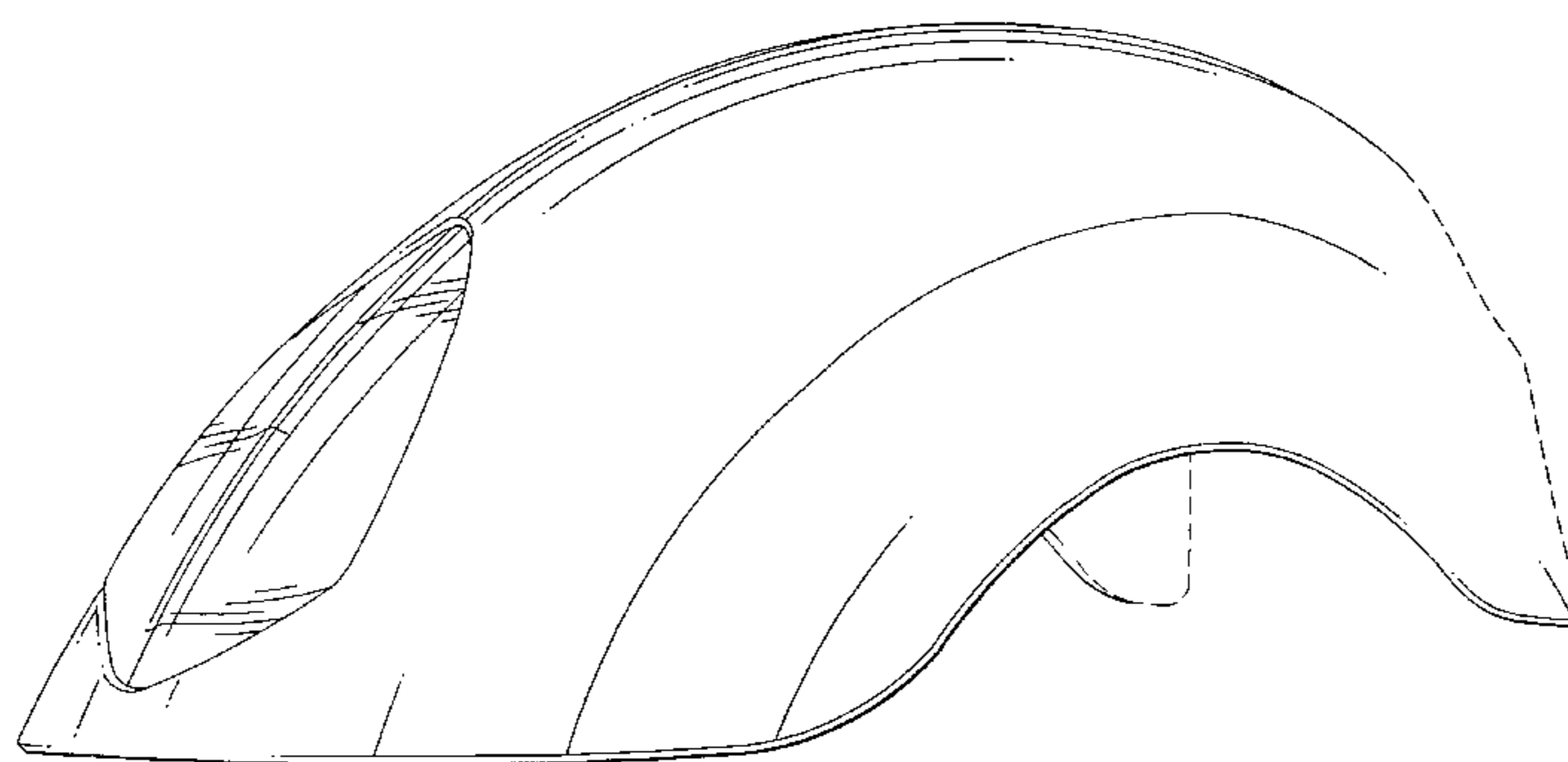

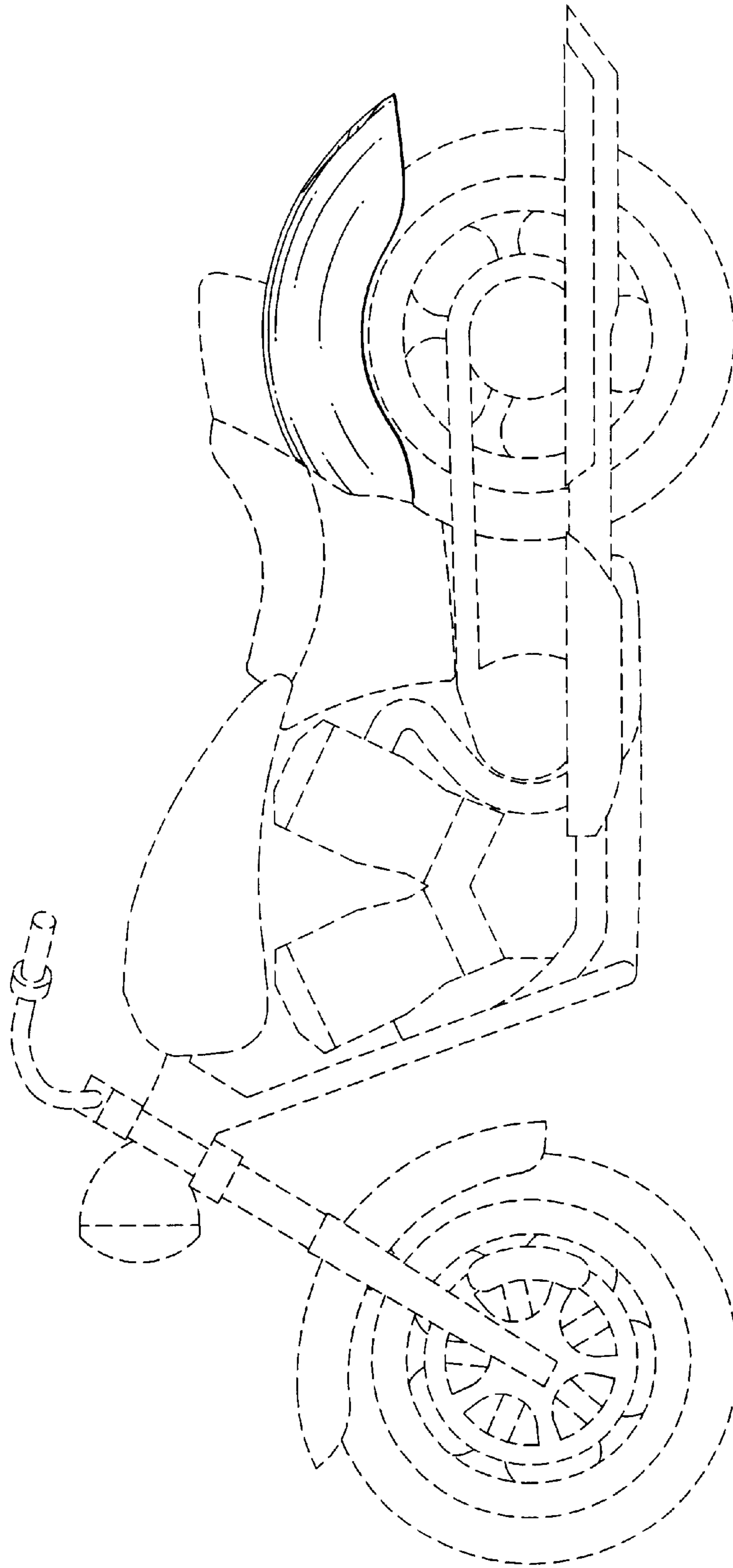

FIG. 1

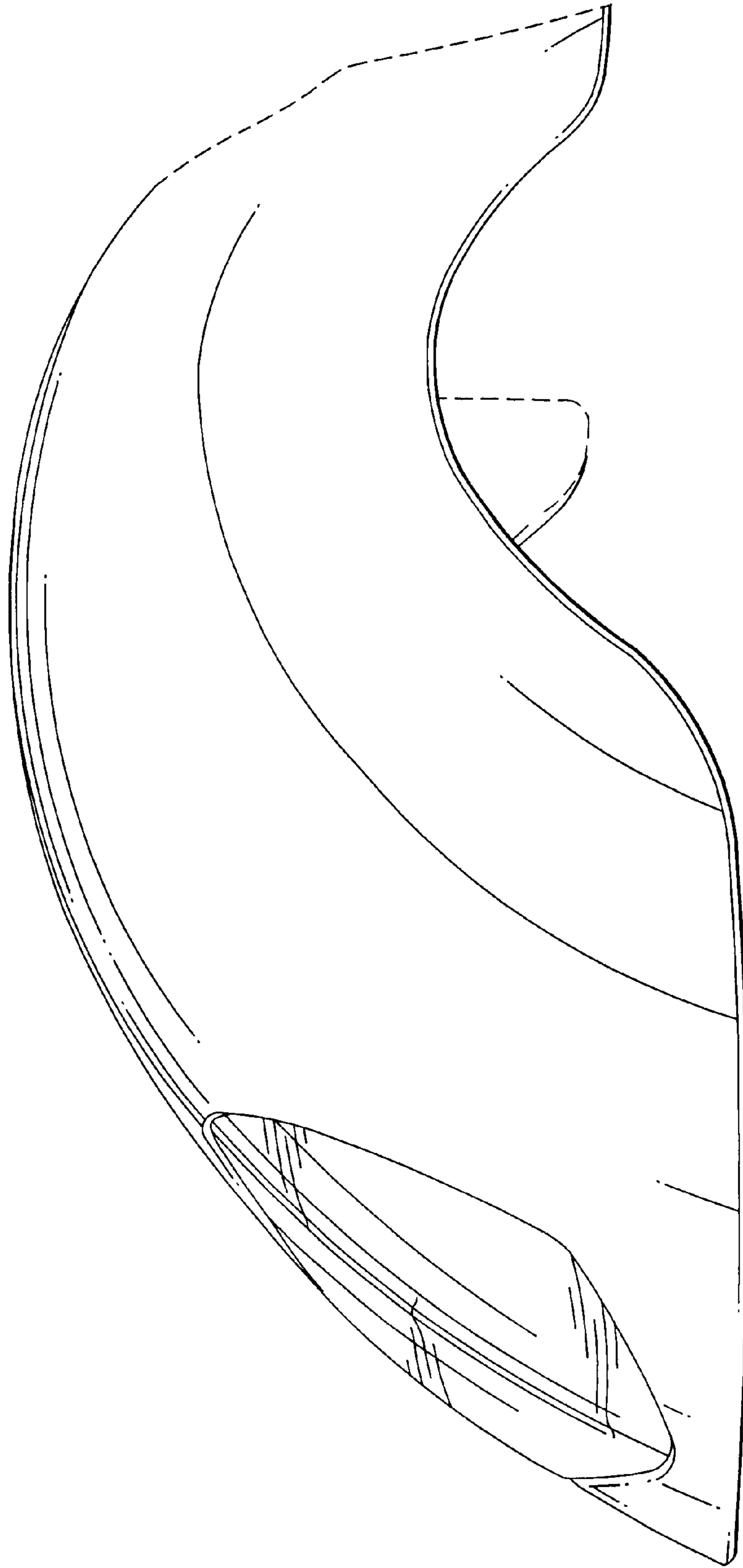

FIG. 2

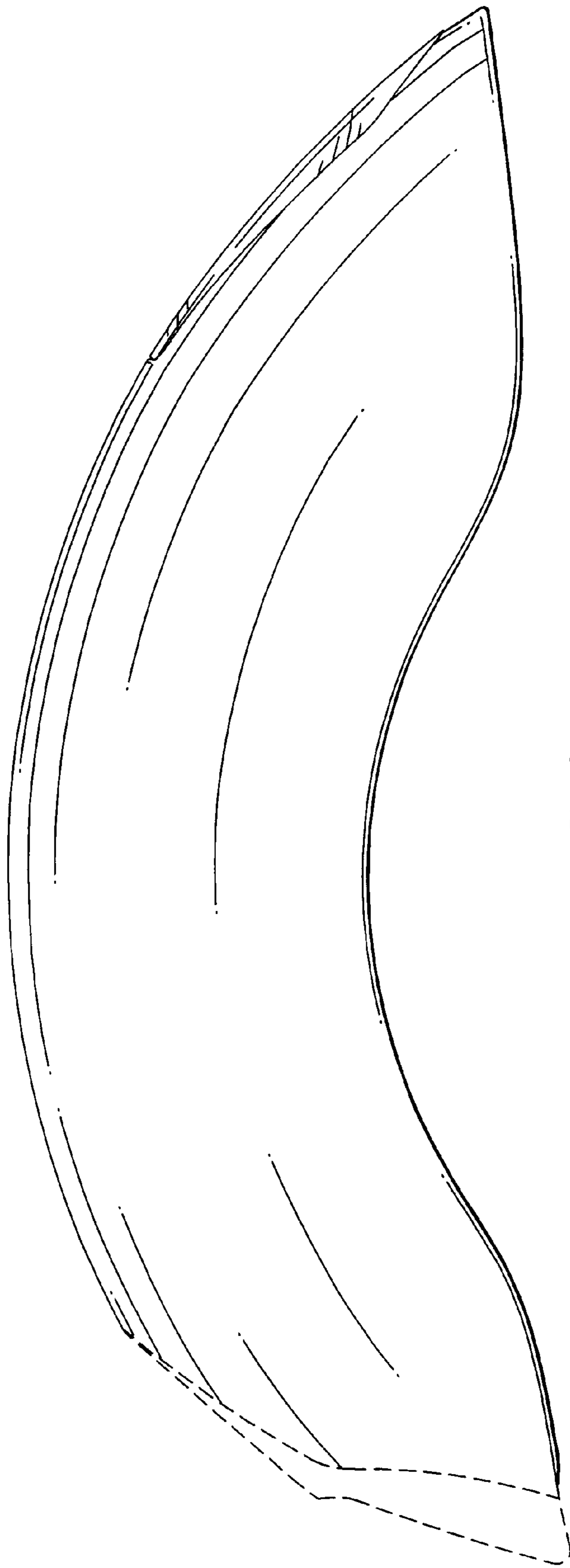

FIG. 3

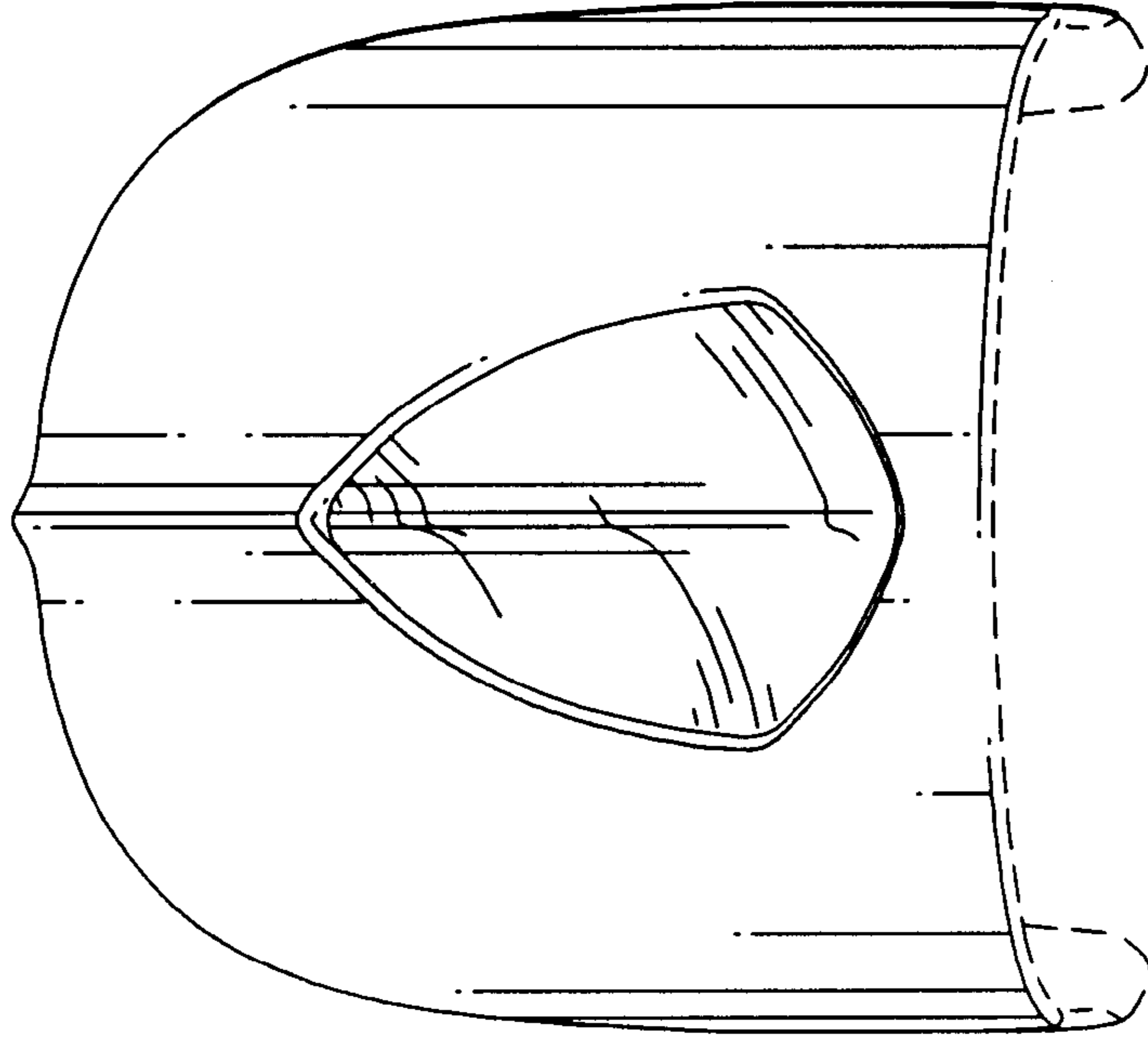

FIG. 5

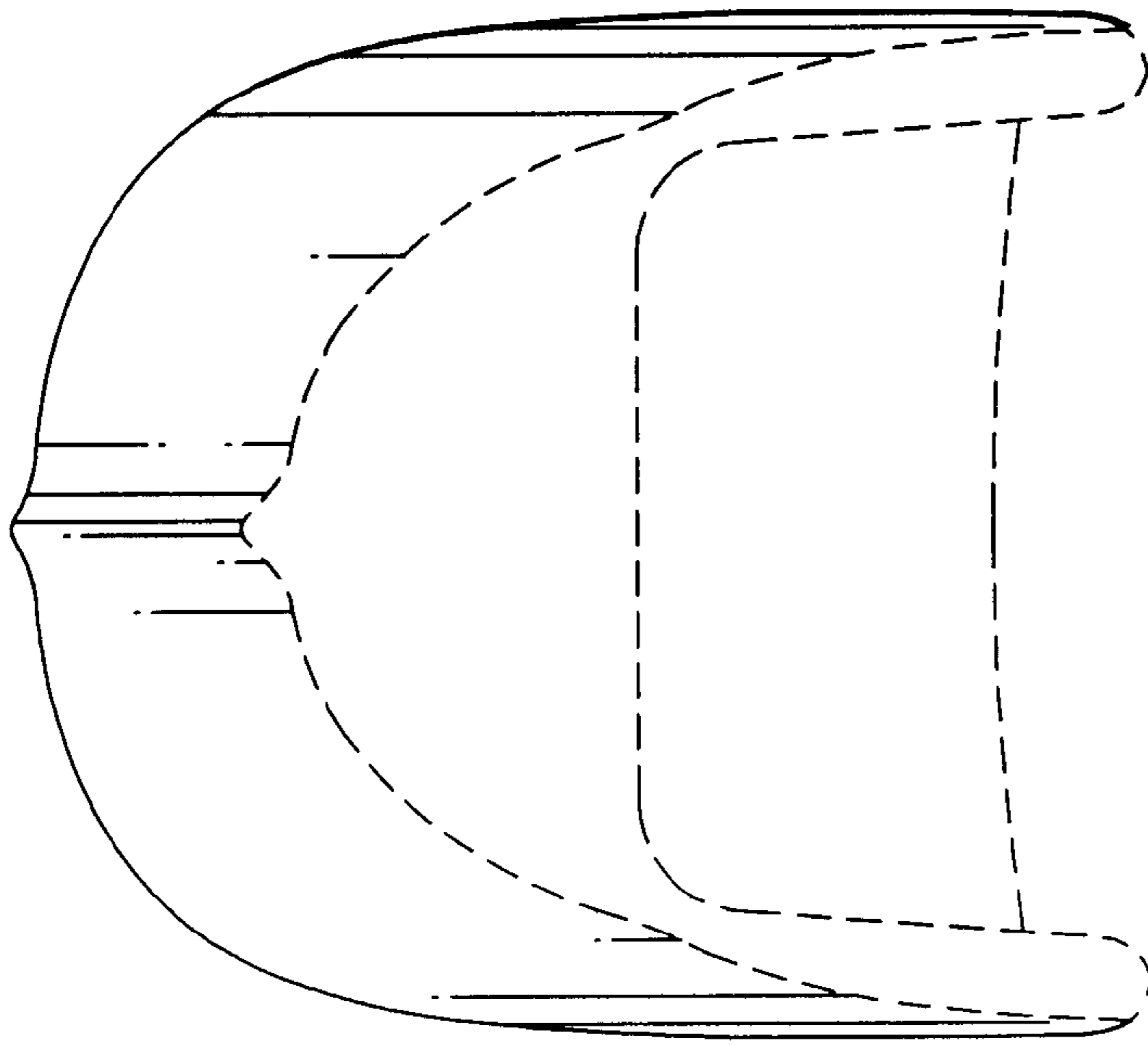

FIG. 4

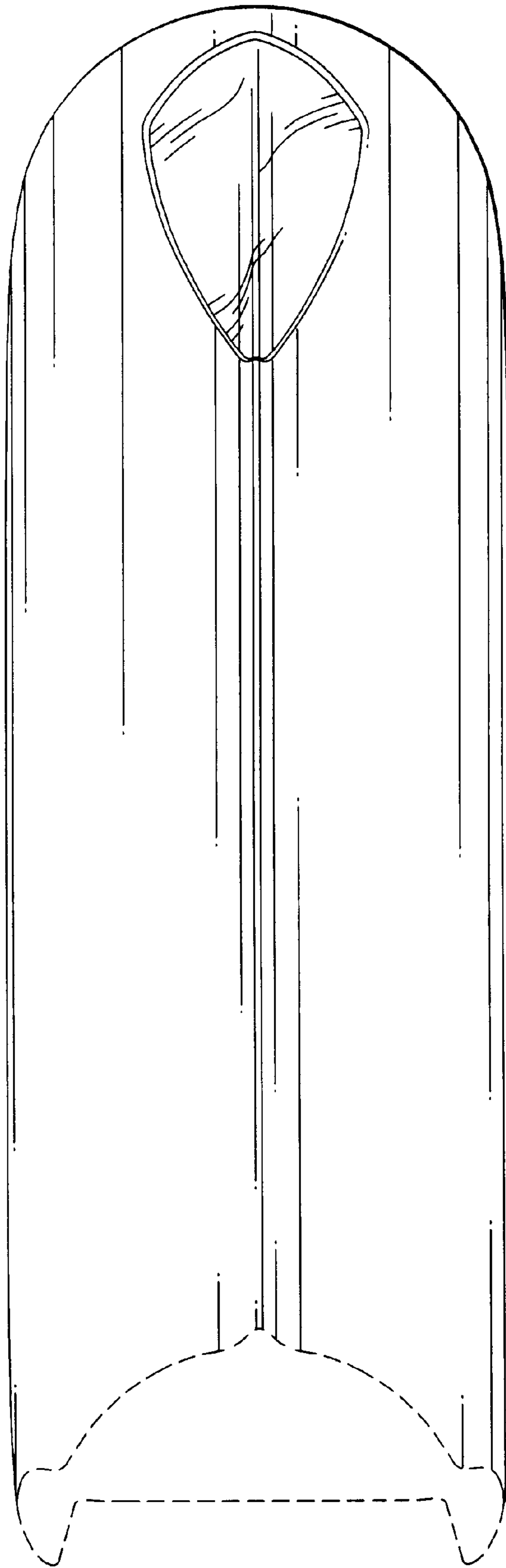

FIG. 6

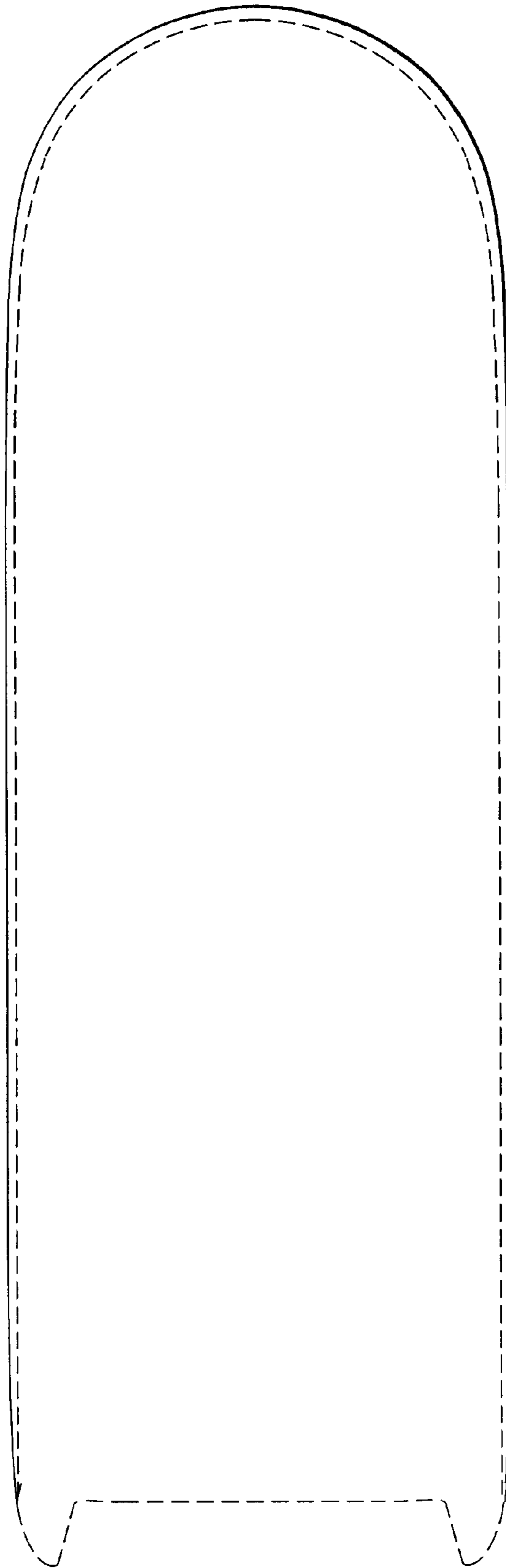

FIG. 7

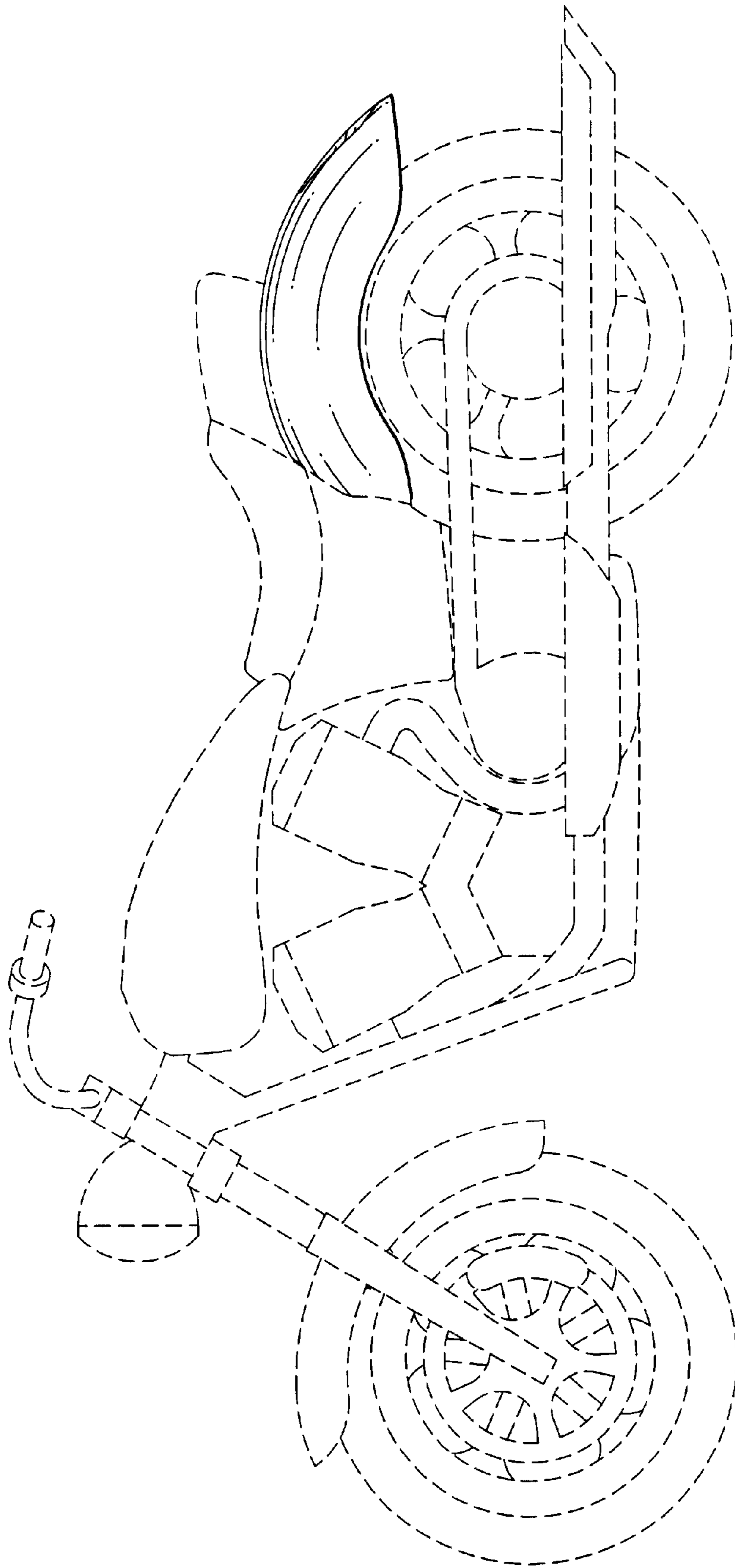

FIG. 8



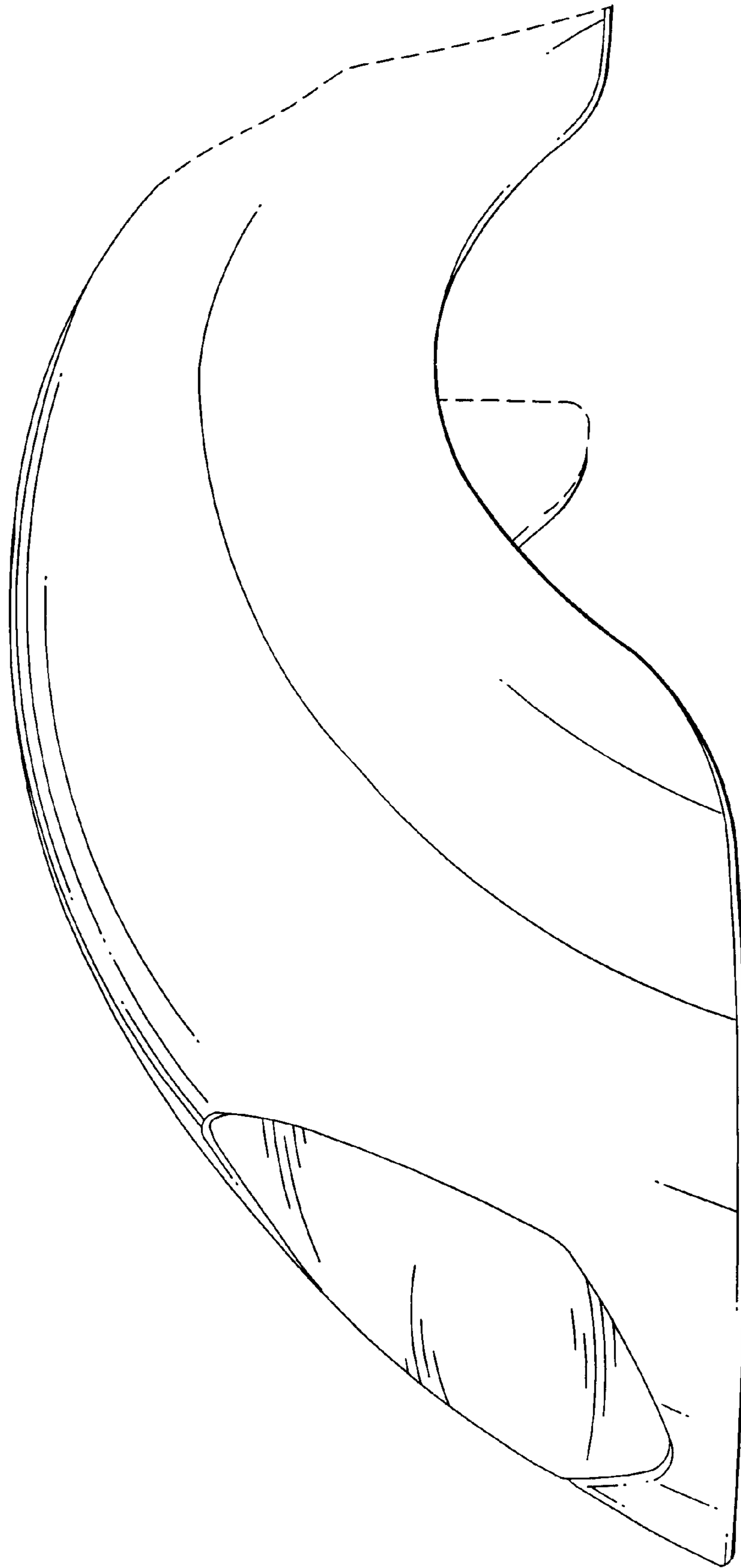

FIG. 9

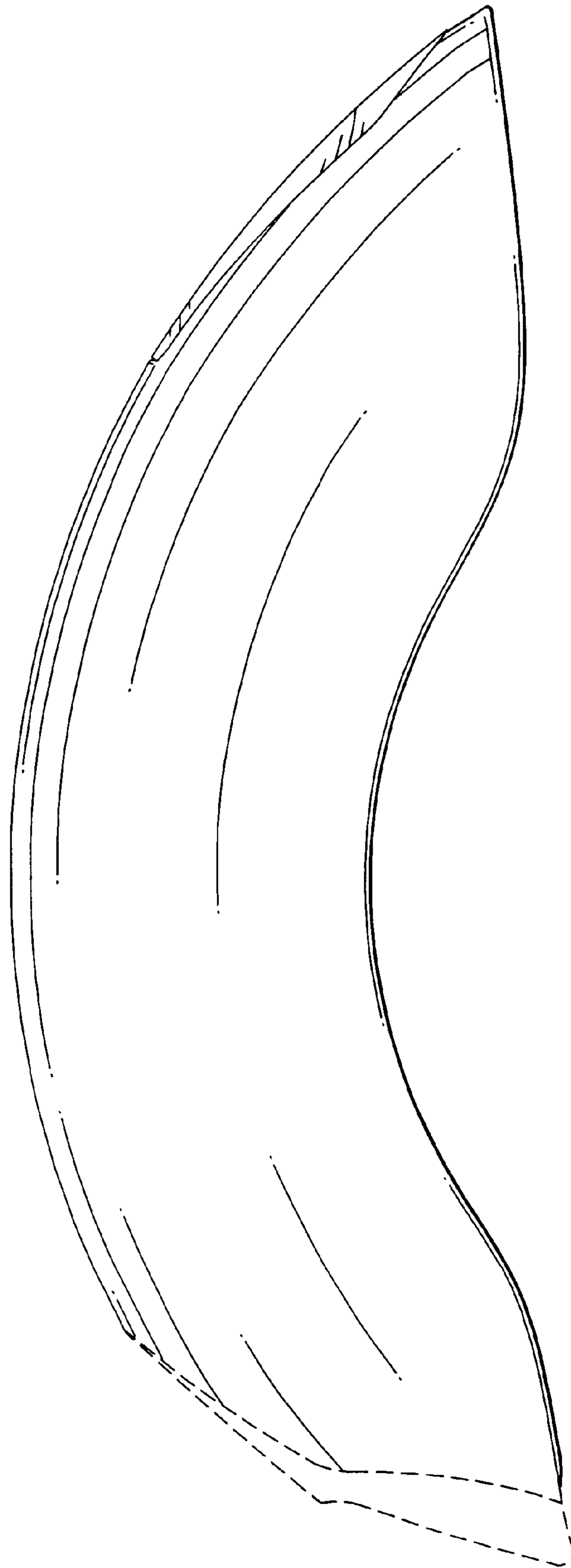

FIG. 10

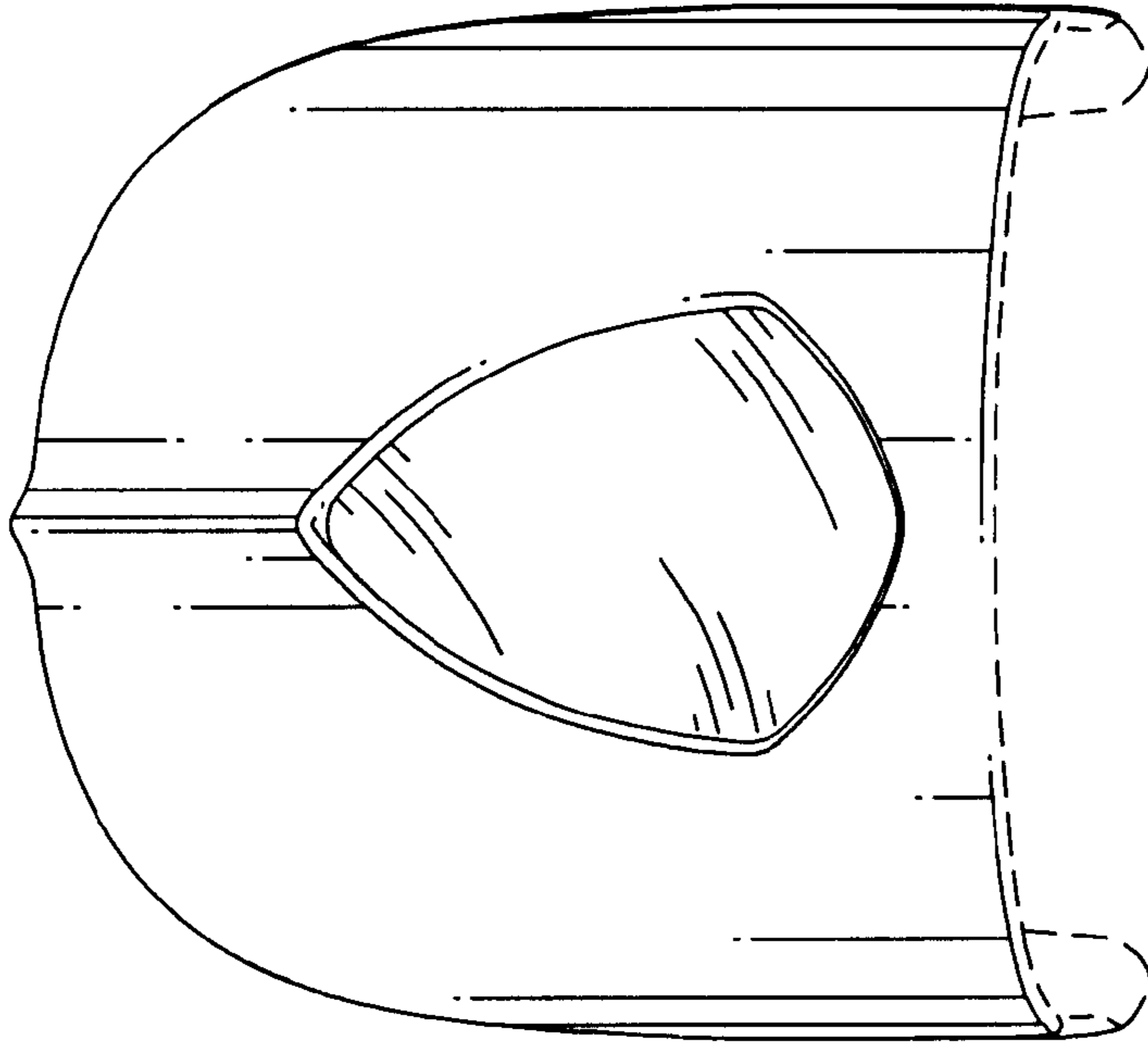

FIG. 12

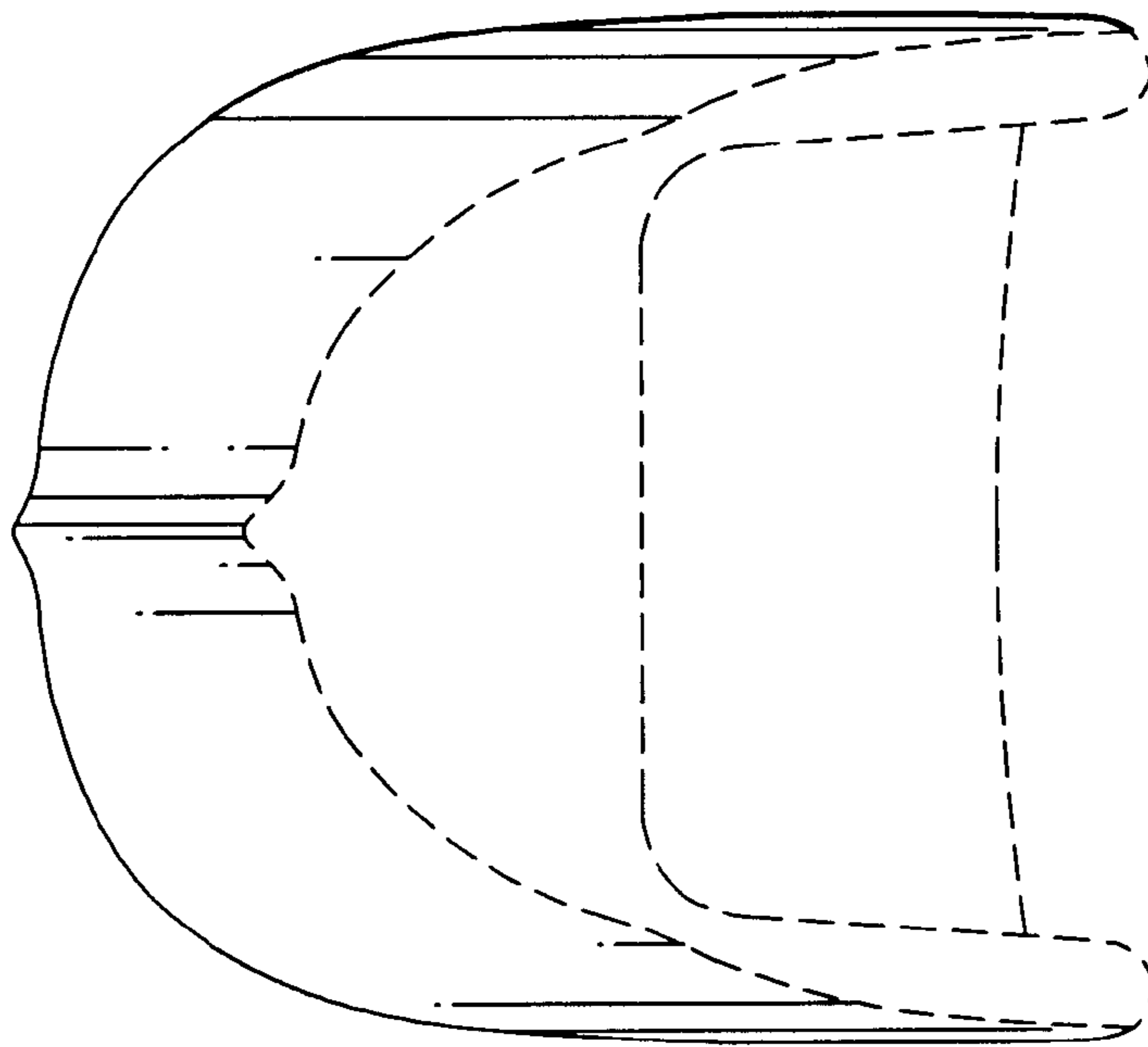

FIG. 11

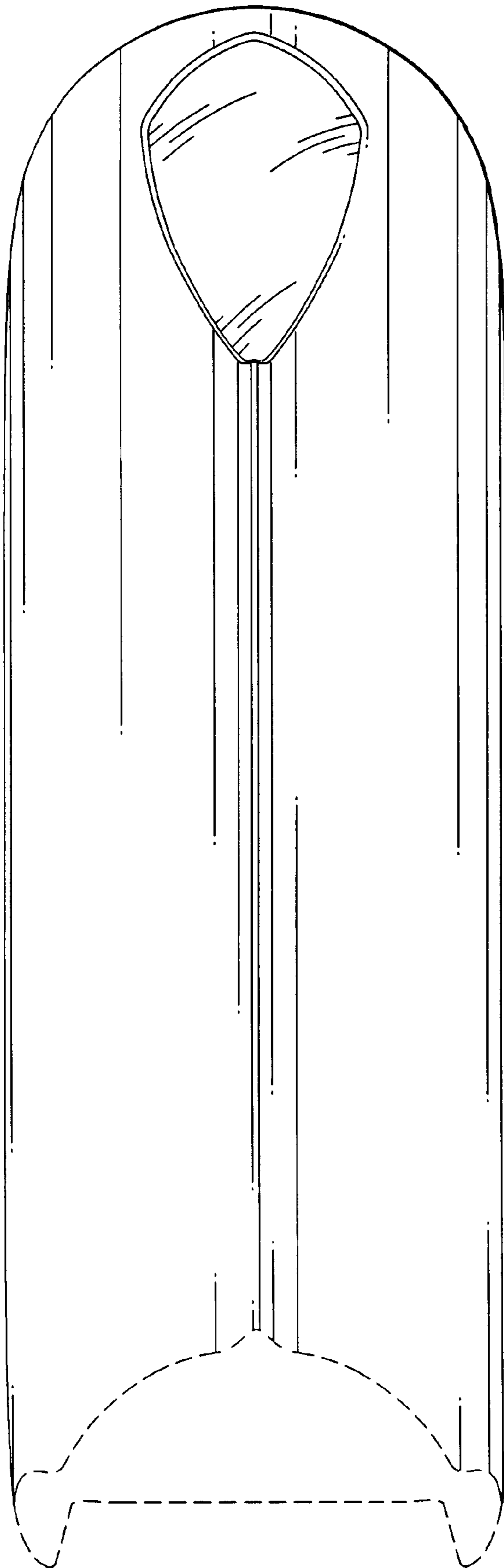

FIG. 13

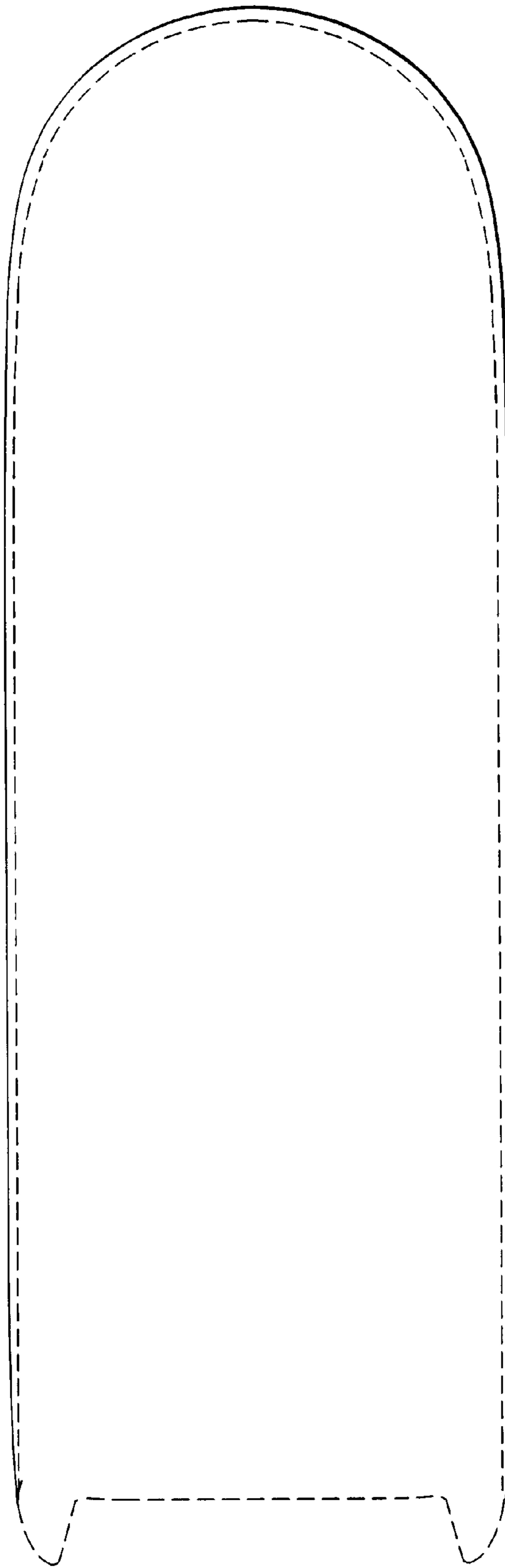

FIG. 14