



US00D481879S

(12) **United States Design Patent**
Su

(10) **Patent No.:** **US D481,879 S**

(45) **Date of Patent:** **** Nov. 11, 2003**

(54) **CHAIR**

(76) **Inventor:** **Tung-Hua Su**, No. 6, Sec. 3, Bao Ta Rd., Kuwi Jen Hsiang, Tainan Hsien (TW)

(**) **Term:** **14 Years**

(21) **Appl. No.:** **29/171,037**

(22) **Filed:** **Nov. 15, 2002**

(51) **LOC (7) Cl.** **06-01**

(52) **U.S. Cl.** **D6/366**

(58) **Field of Search** D6/334, 364, 365, D6/366, 367, 500, 501, 502; 297/411.2, 411.27, 411.36

(56) **References Cited**

U.S. PATENT DOCUMENTS

D227,829 S	*	7/1973	Klose	D6/366
D346,279 S	*	4/1994	Stumpf et al.	D6/366
D423,259 S	*	4/2000	Grove	D6/500
D431,400 S	*	10/2000	Grove	D6/500
D436,260 S	*	1/2001	Nagamitsu	D6/366
D436,456 S	*	1/2001	Neil	D6/366
D437,701 S	*	2/2001	Bellini et al.	D6/366
D440,419 S	*	4/2001	Roder	D6/366

D449,174 S	*	10/2001	Neil	D6/366
D451,293 S	*	12/2001	Su	D6/366
D451,294 S	*	12/2001	Simons et al.	D6/366
D453,079 S	*	1/2002	Ma	D6/366
D454,450 S	*	3/2002	Chu	D6/500
D456,626 S	*	5/2002	Su	D6/366
D461,323 S	*	8/2002	Su	D6/366
D462,188 S	*	9/2002	Su	D6/366

* cited by examiner

Primary Examiner—Gary D. Watson

(74) *Attorney, Agent, or Firm*—Charles E. Baxley

(57) **CLAIM**

The ornamental design for a chair, as shown.

DESCRIPTION

FIG. 1 is a perspective view of a chair showing my new design;

FIG. 2 is a front elevation view thereof;

FIG. 3 is a rear elevation view thereof;

FIG. 4 is a left side elevation view thereof;

FIG. 5 is a right side elevation view thereof;

FIG. 6 is a top plan view thereof; and,

FIG. 7 is a bottom plan view thereof.

1 Claim, 6 Drawing Sheets

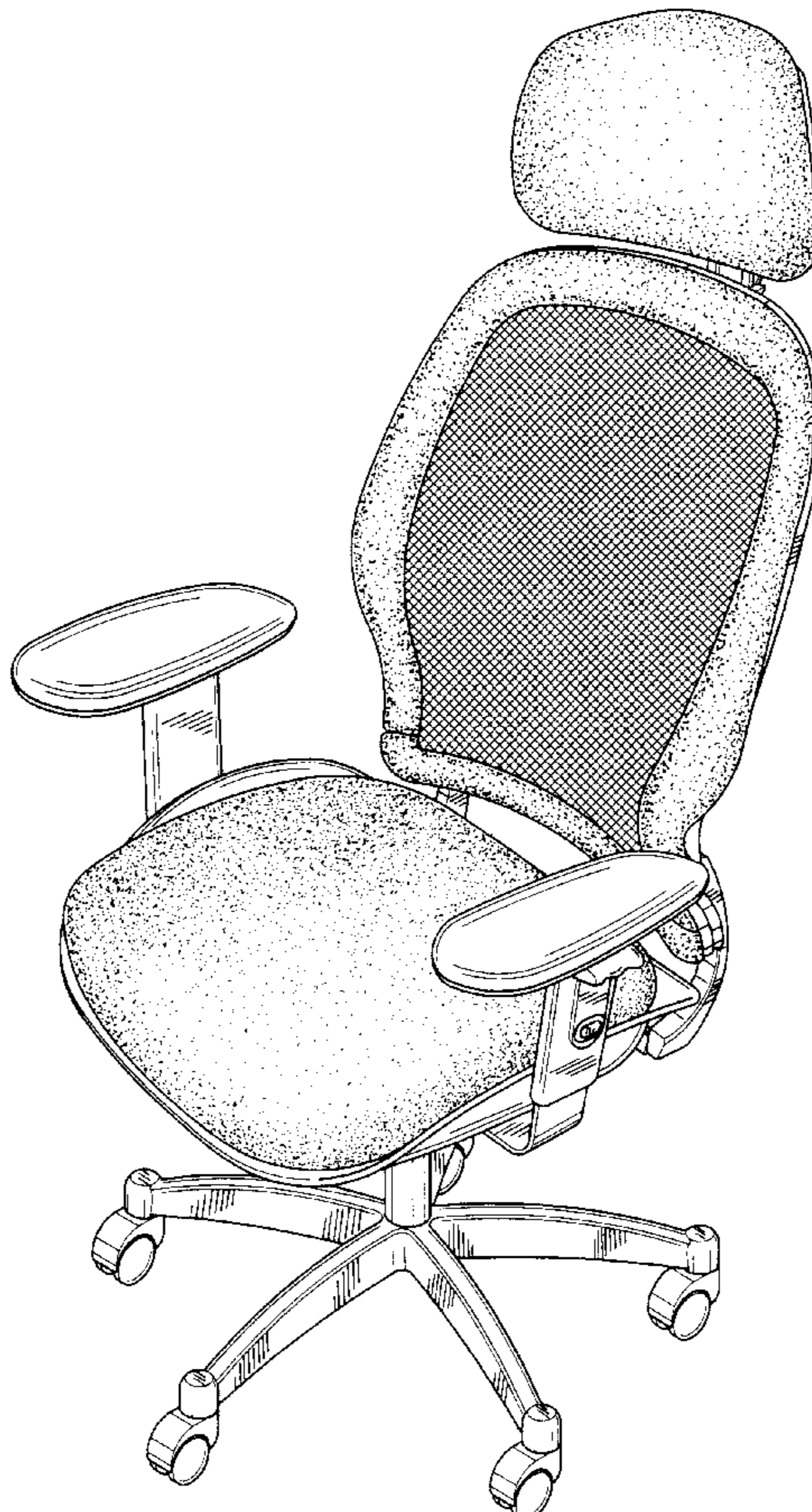



FIG. 1

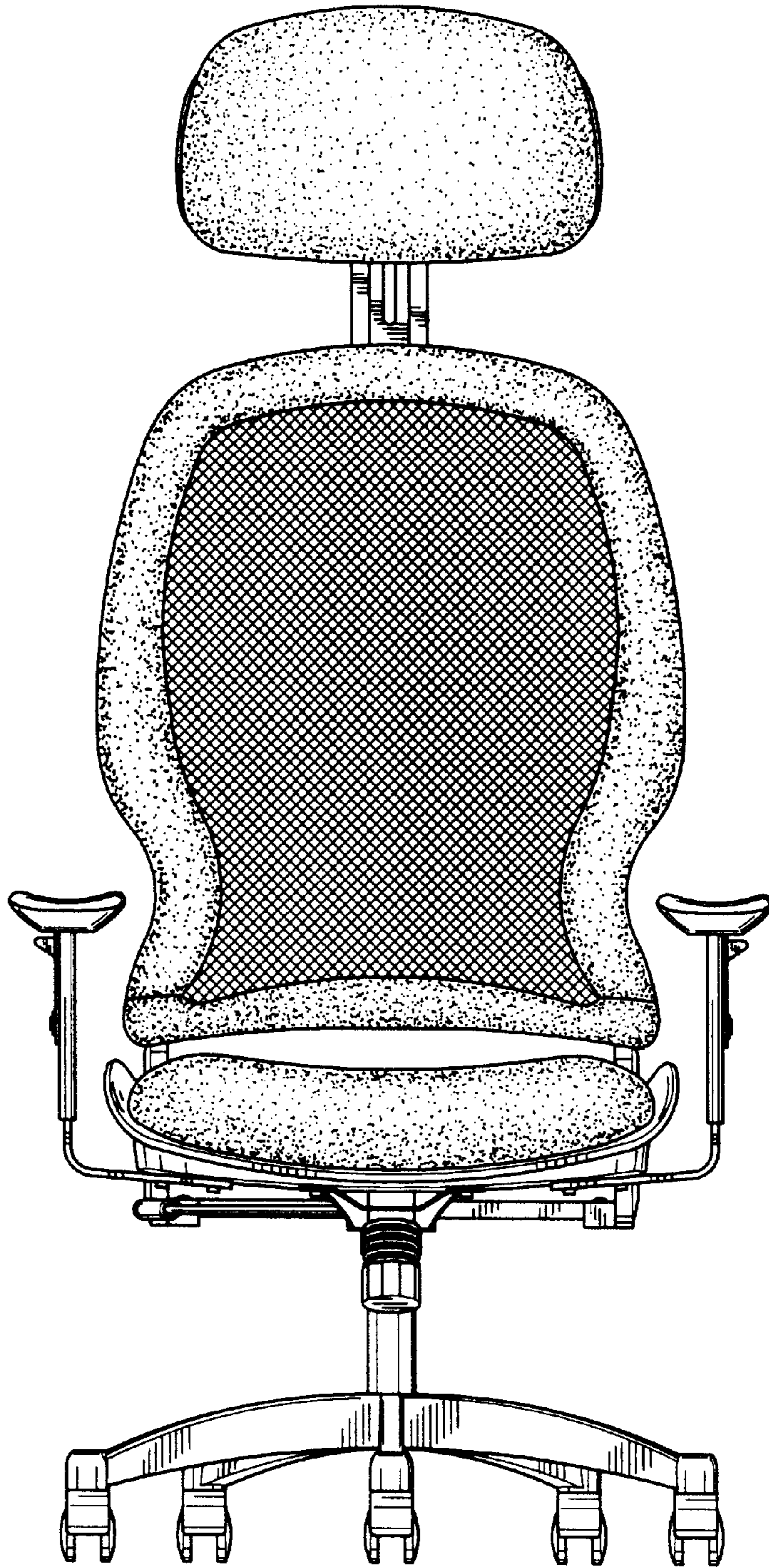

FIG. 2

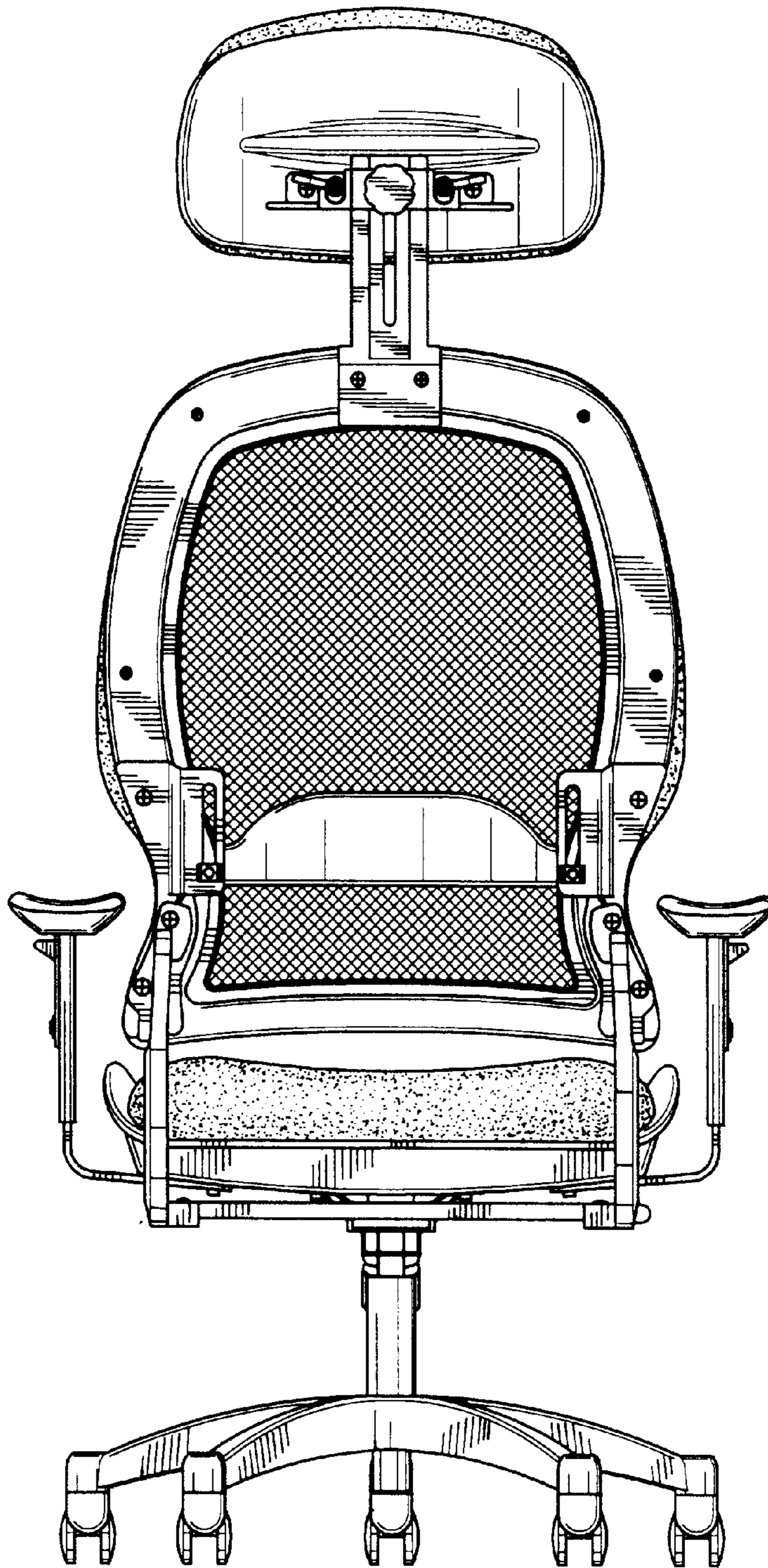

FIG. 3

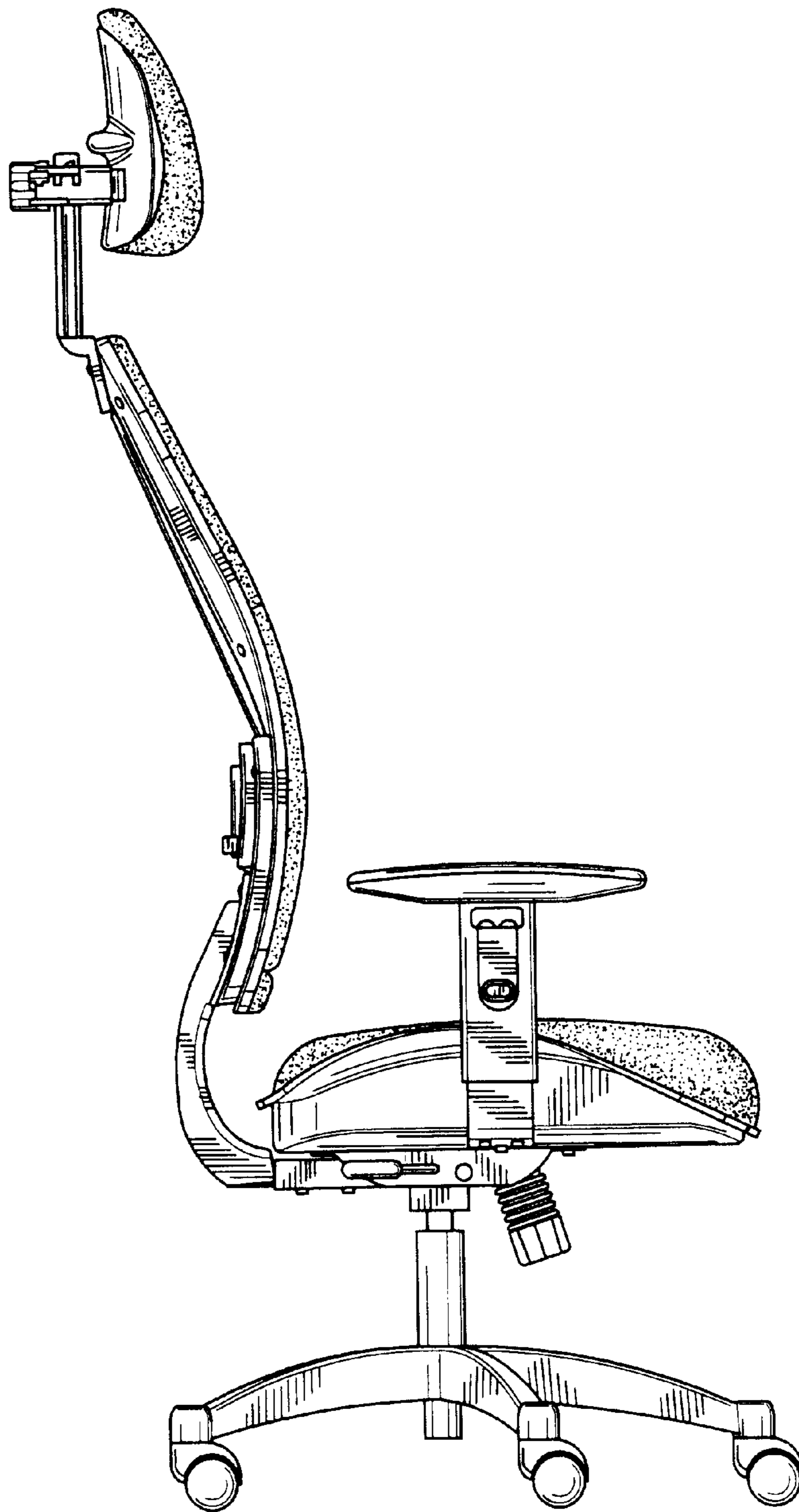

FIG. 4

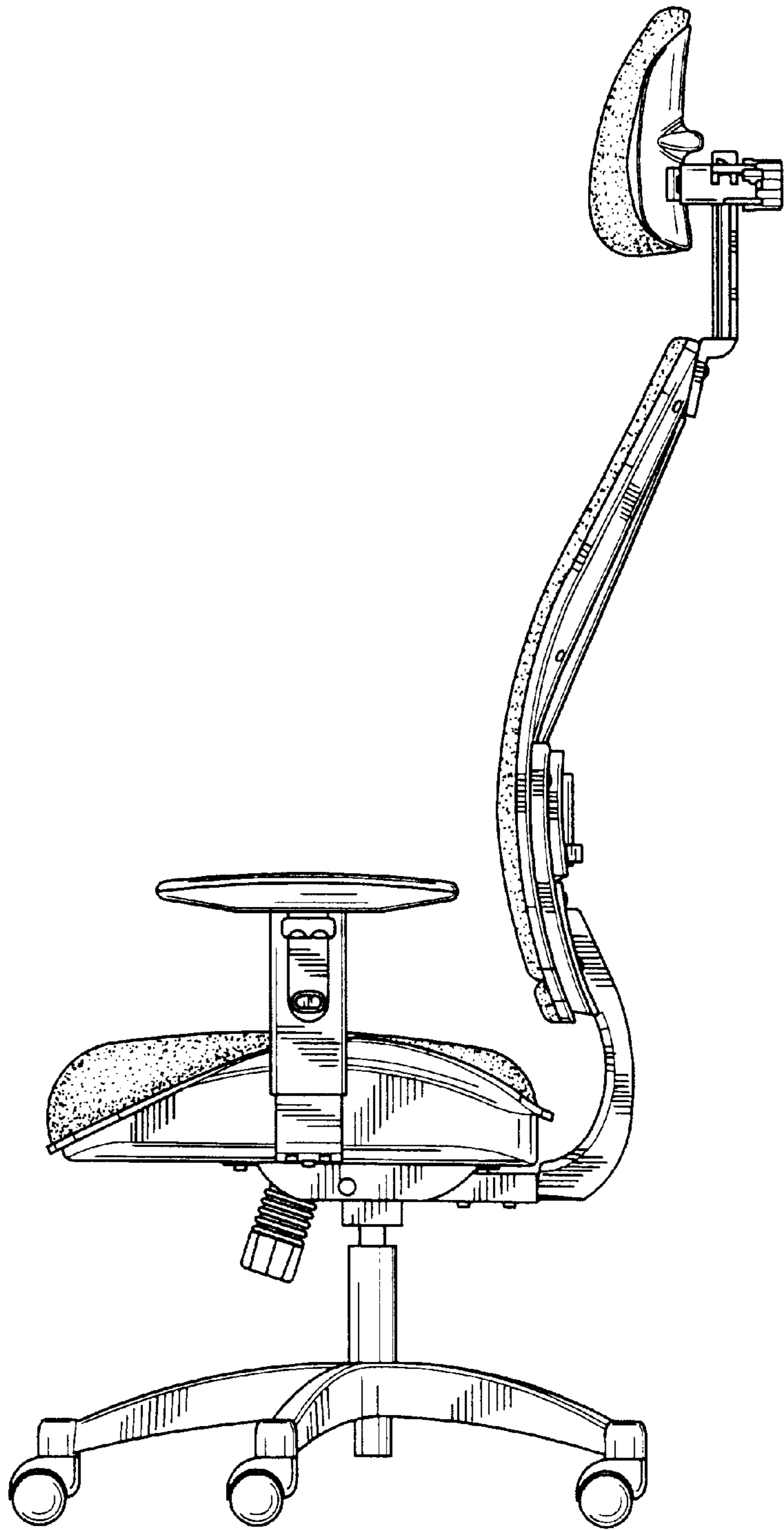

FIG. 5

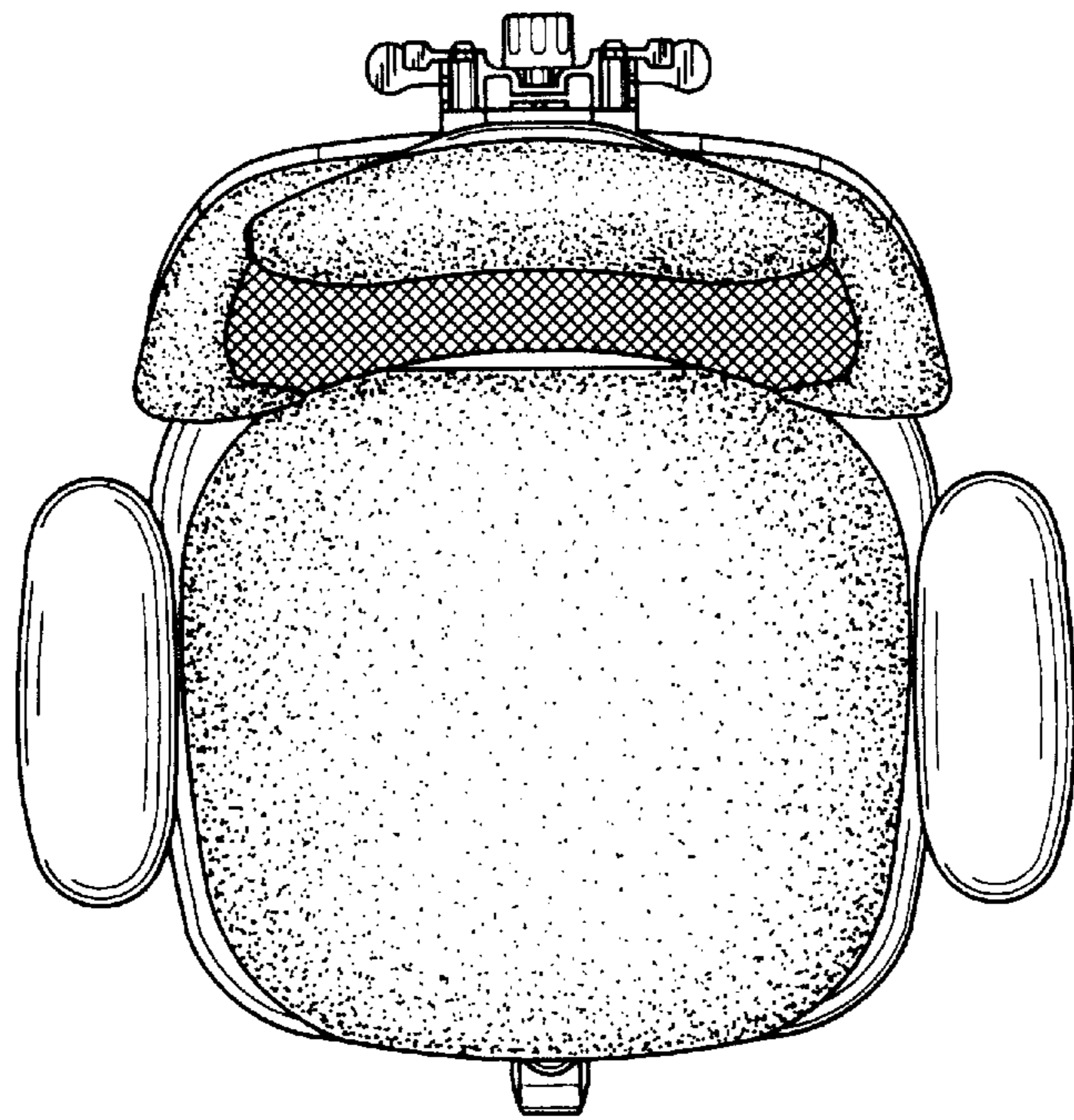

FIG. 6

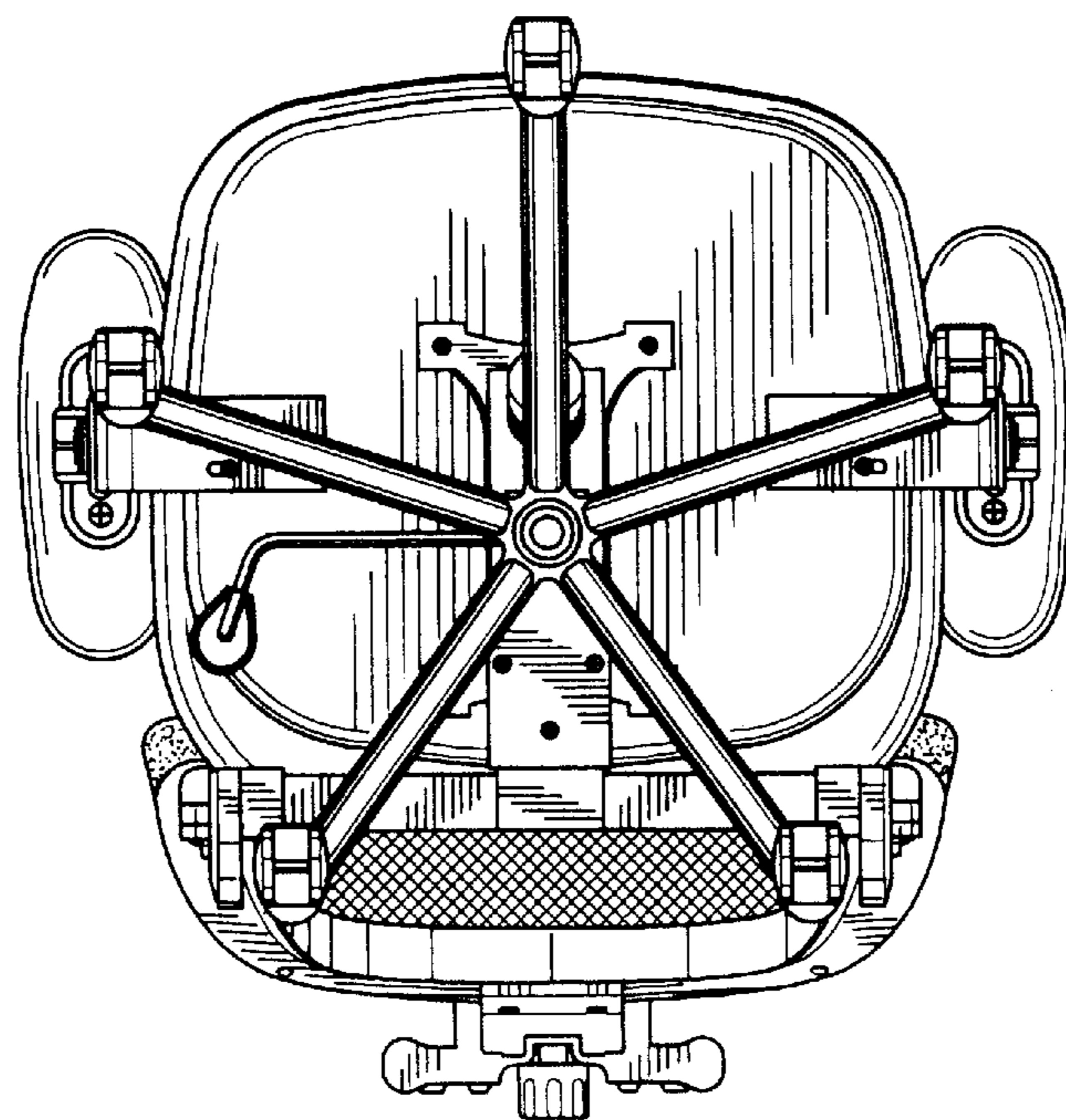

FIG. 7