



US00D481794S

(12) **United States Design Patent**
Krinsky

(10) **Patent No.:** **US D481,794 S**

(45) **Date of Patent:** **** Nov. 4, 2003**

(54) **NASAL CLEANSING NETI POT**

(75) **Inventor:** **Santosh Krinsky**, Twin Lakes, WI (US)

(73) **Assignee:** **Lotus Brands Incorporated**, Silver Lake, WI (US)

(**) **Term:** **14 Years**

(21) **Appl. No.:** **29/167,516**

(22) **Filed:** **Sep. 16, 2002**

(51) **LOC (7) Cl.** **24-01**

(52) **U.S. Cl.** **D24/108; D24/110; D24/121; D24/133**

(58) **Field of Search** **D24/107, 110, D24/108, 111, 121, 133; D23/212; D7/590, 302, 318, 319, 300, 304, 312; 604/94.01, 73, 93.01, 275, 217**

(56) **References Cited**

U.S. PATENT DOCUMENTS

1,599,787	A	*	9/1926	Perkiss	604/275
D216,599	S	*	2/1970	Jacobsen	D7/321
6,241,705	B1	*	6/2001	Ko-Wen	604/73
6,540,718	B1	*	4/2003	Wennek	604/94.01
2002/0169422	A1	*	11/2002	Ahnblad et al.	604/217

* cited by examiner

Primary Examiner—Ian Simmons

(74) *Attorney, Agent, or Firm*—Fitch, Even, Tabin & Flannery

(57) **CLAIM**

I claim the ornamental design for a nasal cleansing neti pot, as shown and described.

DESCRIPTION

FIG. 1 is a perspective view of a nasal cleansing neti pot showing my new invention;

FIG. 2 is a top plan view of the nasal cleansing neti pot of FIG. 1;

FIG. 3 is a right side elevational view of the nasal cleansing neti pot of FIG. 1;

FIG. 4 is a bottom plan view of the nasal cleansing neti pot of FIG. 1;

FIG. 5 is a front elevational view of the nasal cleansing neti pot of FIG. 1;

FIG. 6 is a rear elevational view of the nasal cleansing neti pot of FIG. 1; and,

FIG. 7 is a left side elevational view of the nasal cleansing neti pot of FIG. 1.

1 Claim, 2 Drawing Sheets

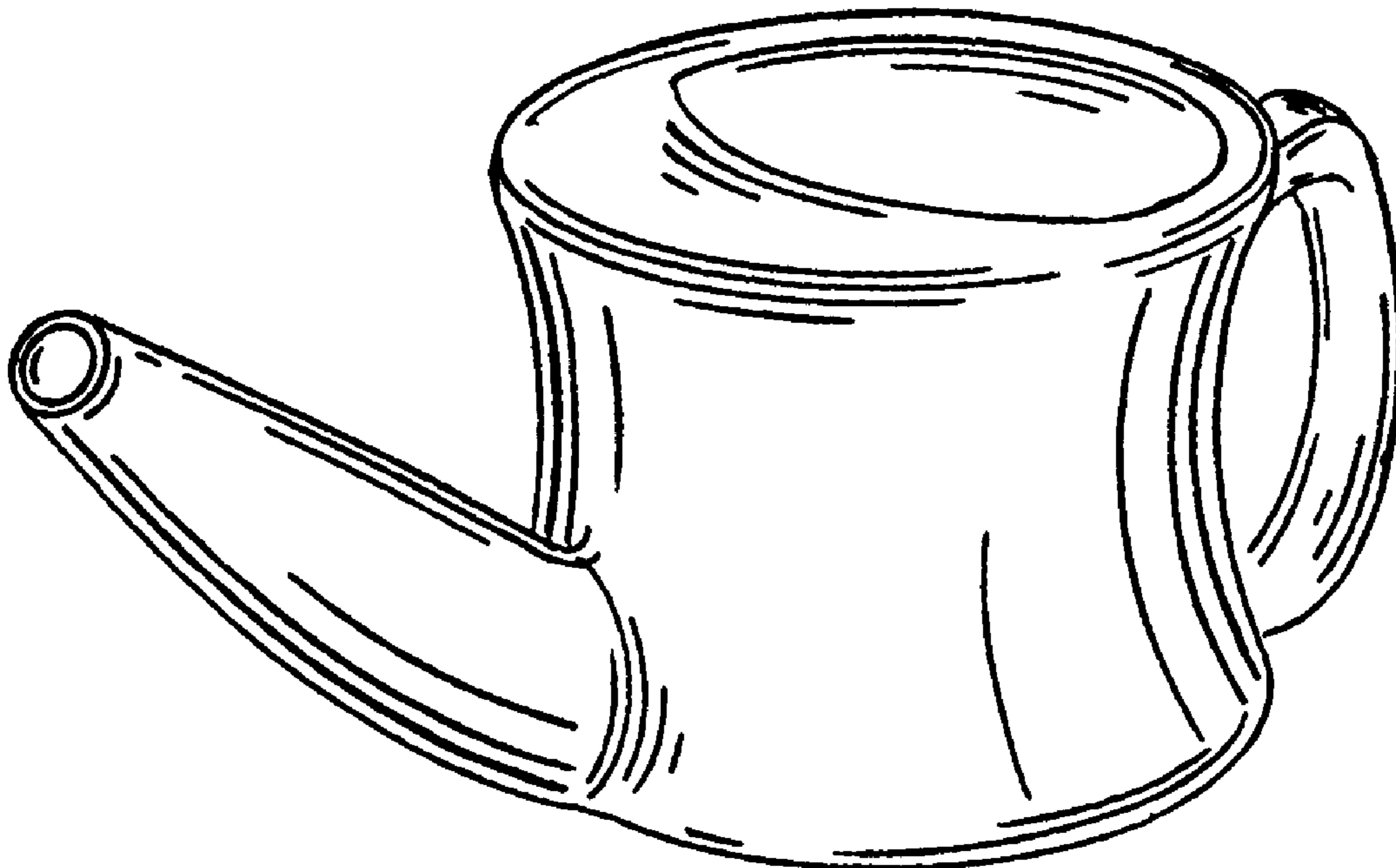

FIG. 1

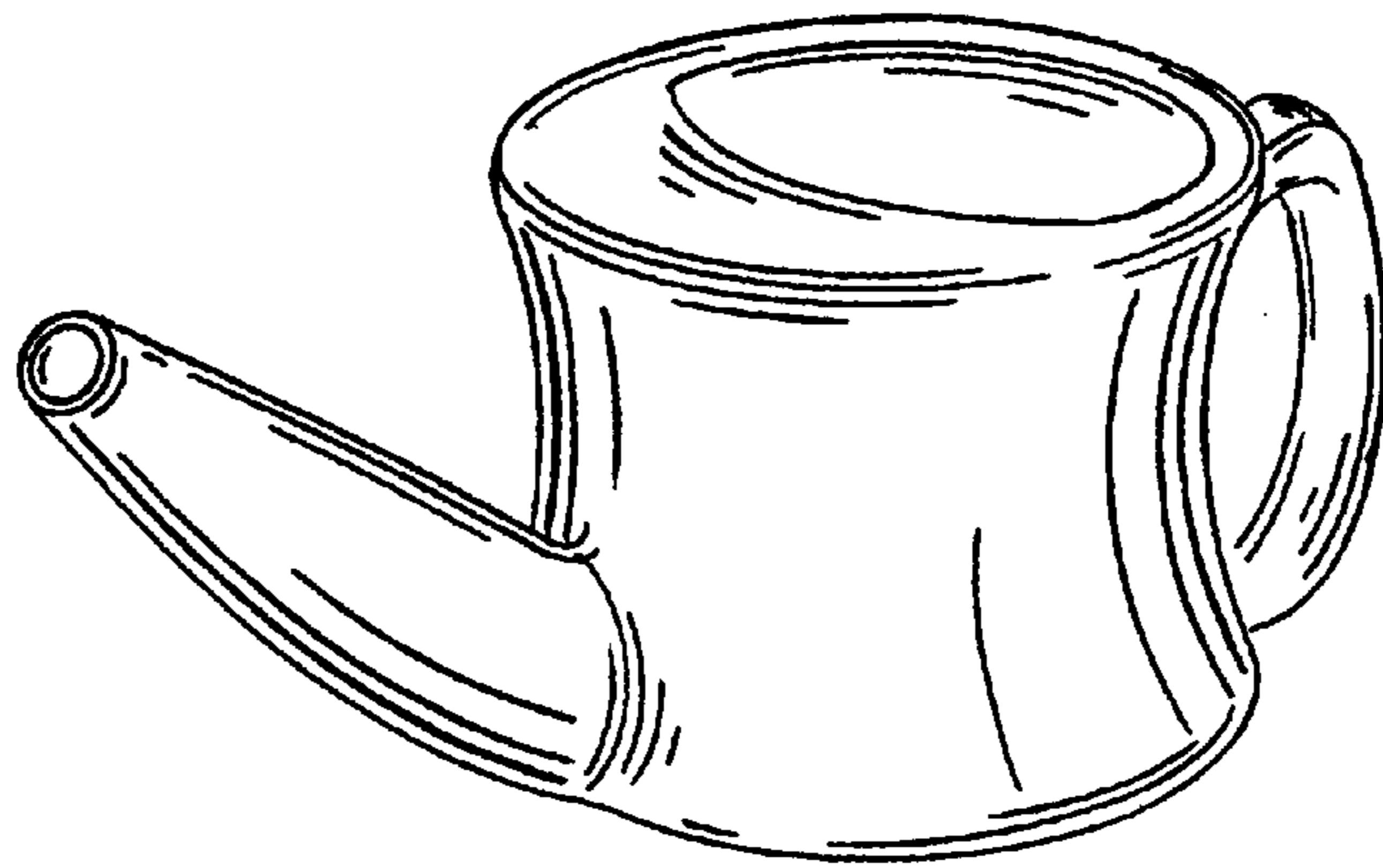

FIG. 2

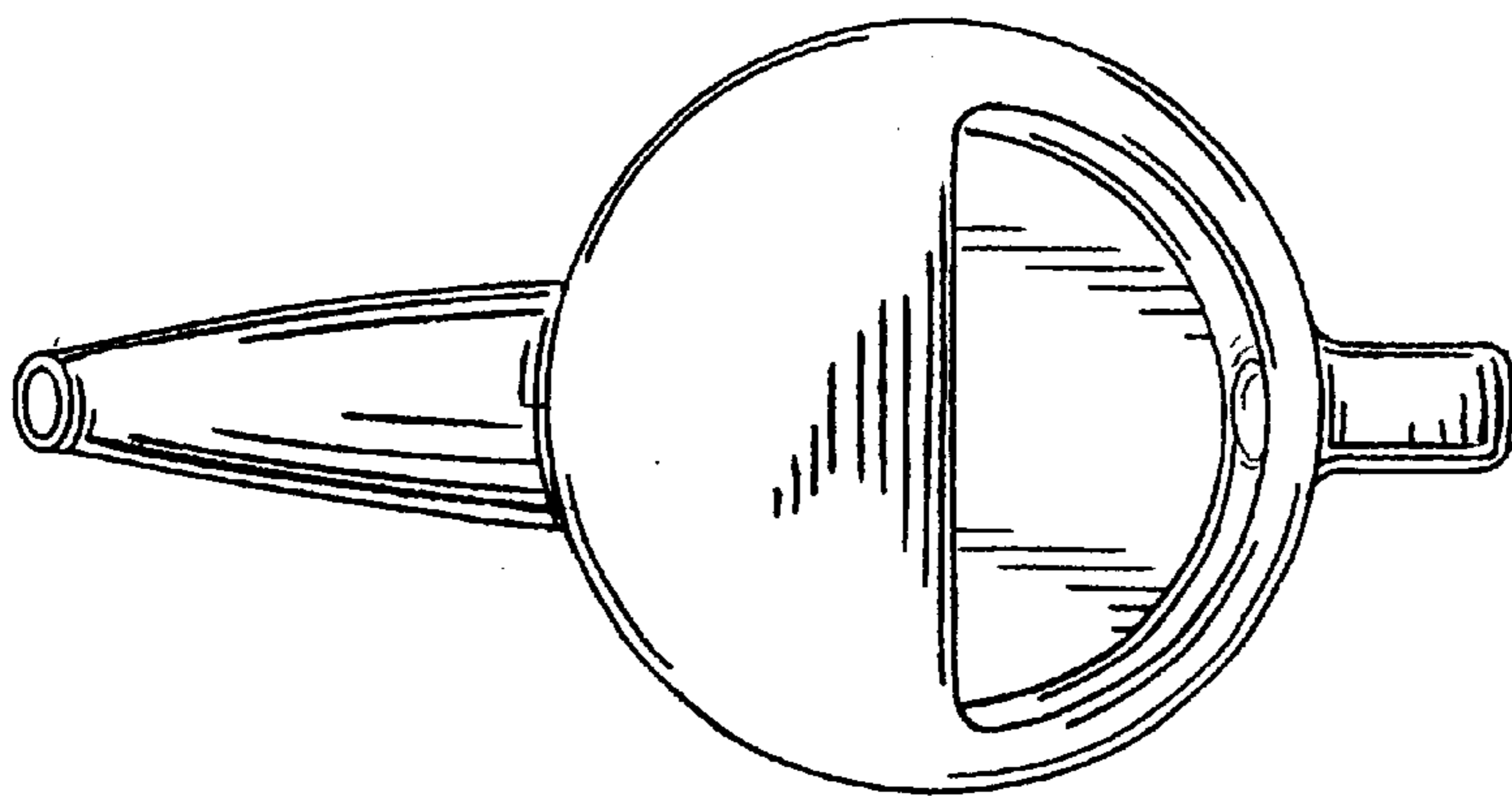
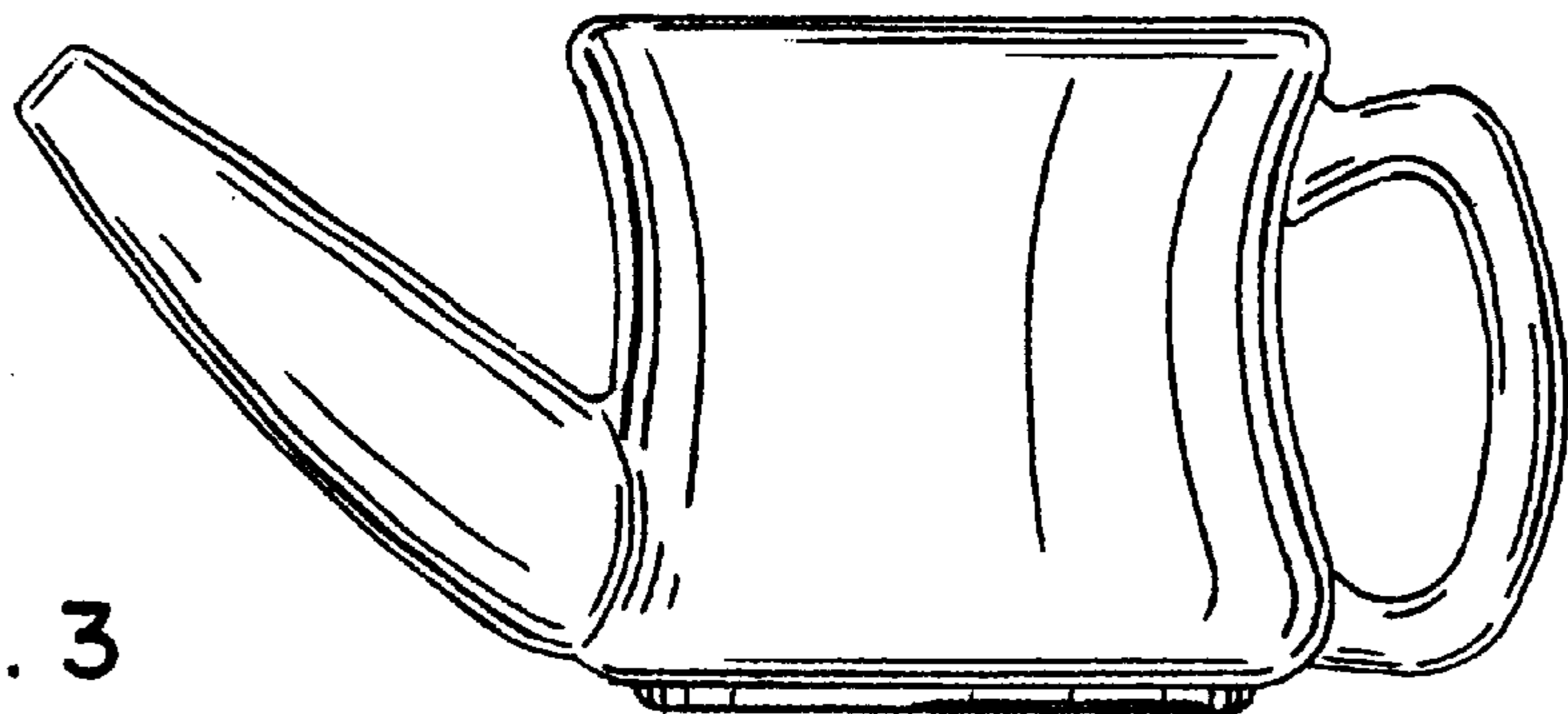

FIG. 3



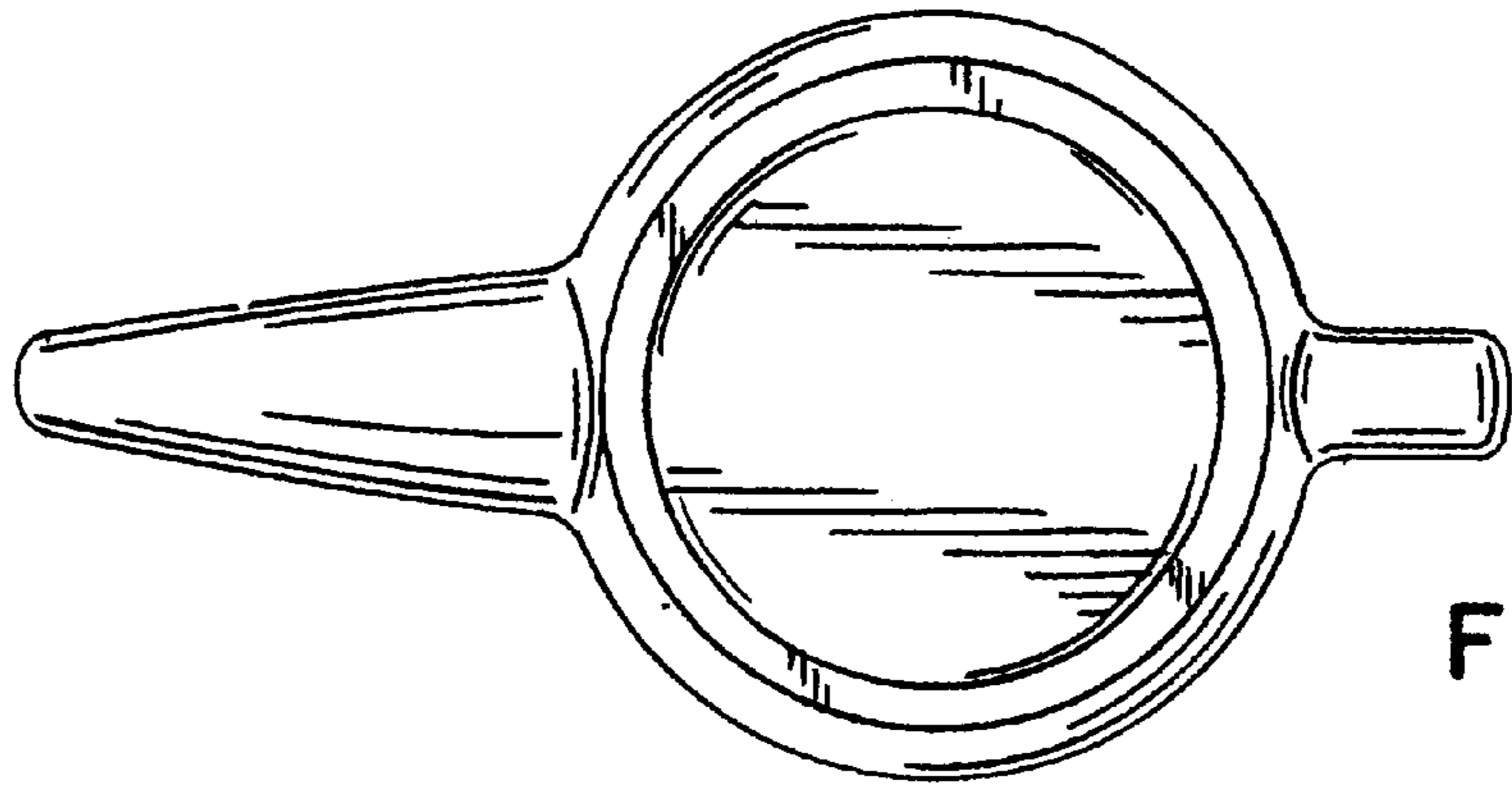

FIG. 4

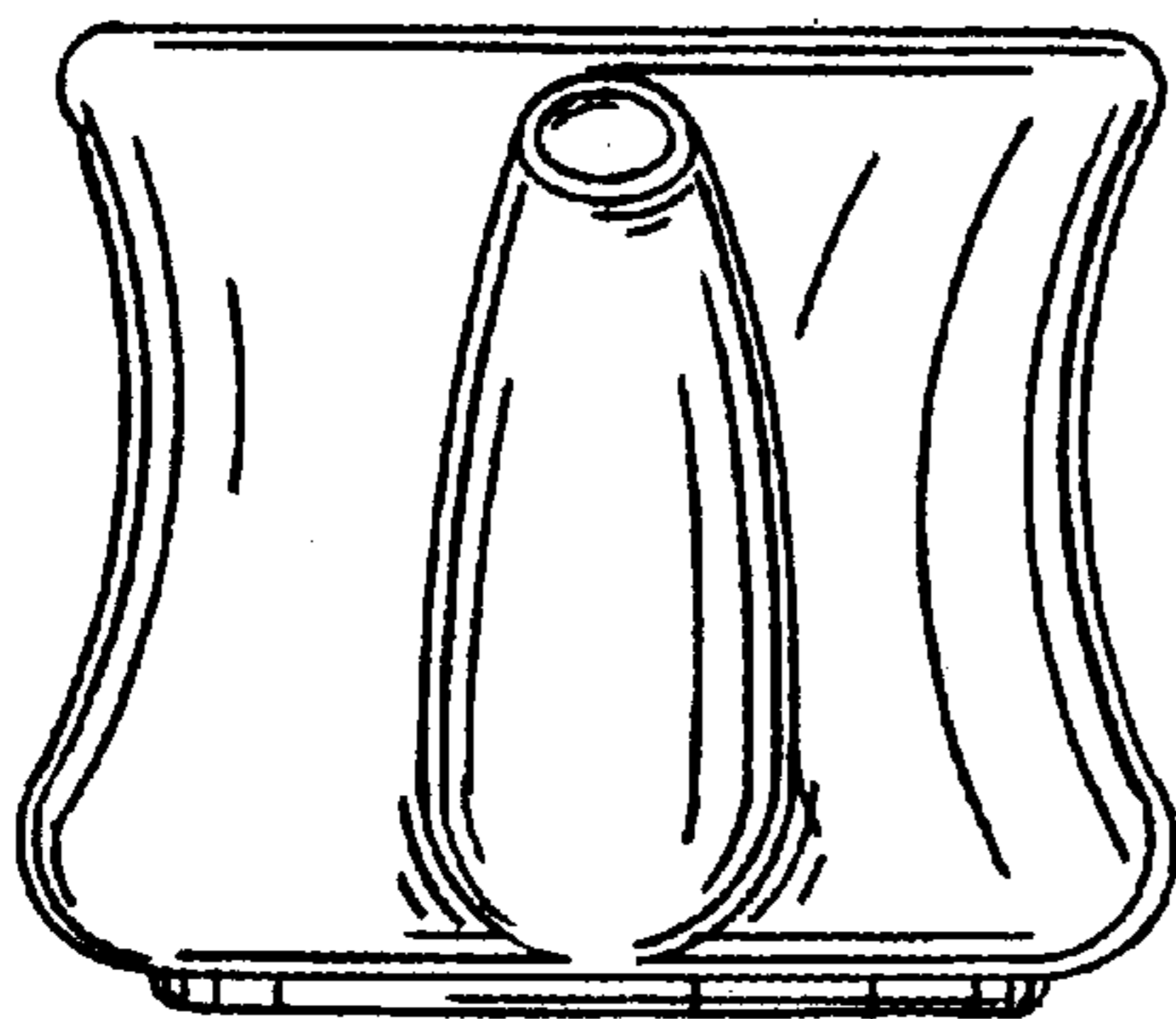

FIG. 5

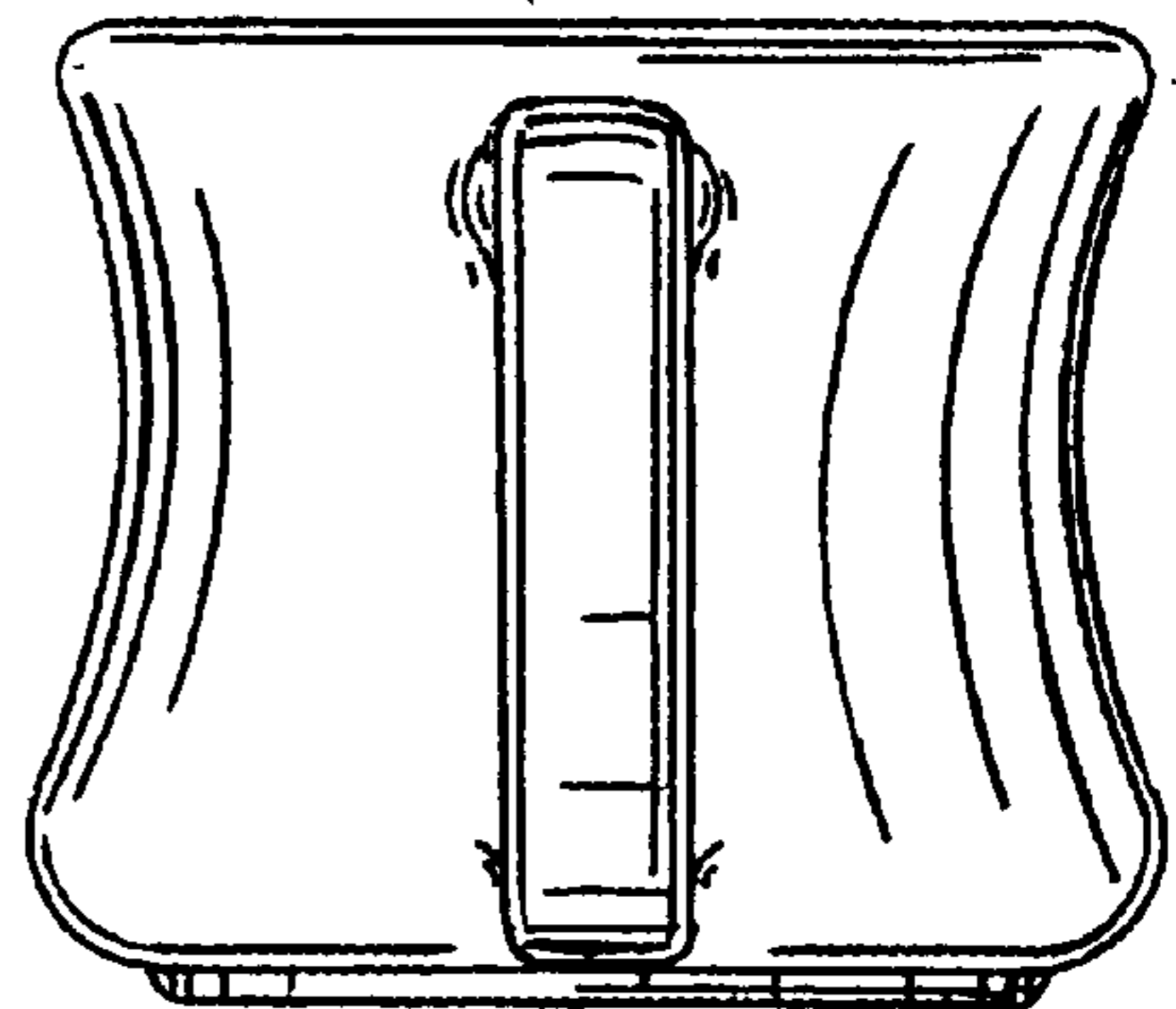

FIG. 6

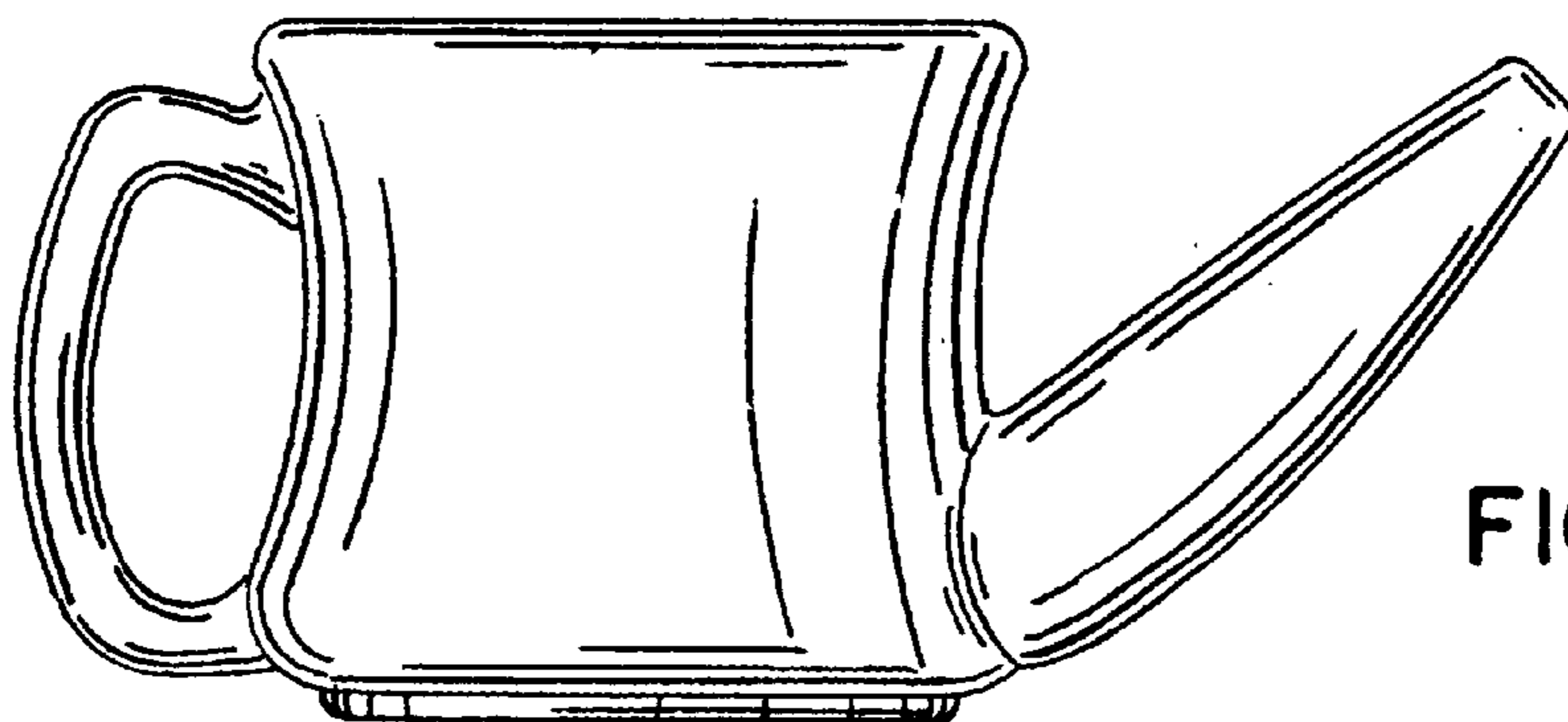

FIG. 7