



US00D481741S

(12) **United States Design Patent**
Yuen

(10) **Patent No.:** **US D481,741 S**

(45) **Date of Patent:** **** Nov. 4, 2003**

(54) **MINI SIZE SOLID STATE REFRIGERATOR**

D454,892 S * 3/2002 Black et al. D15/83
D471,922 S * 3/2003 Sawhney et al. D15/81

(75) **Inventor:** **Se Kit Yuen, Kwun Tong (HK)**

* cited by examiner

(73) **Assignee:** **John Manufacturing Ltd., Kowloon (HK)**

Primary Examiner—Mitchell Siegel
(74) *Attorney, Agent, or Firm*—Merchant & Gould P.C.

(**) **Term:** **14 Years**

(57) **CLAIM**

(21) **Appl. No.:** **29/167,987**

The ornamental design for mini size solid state refrigerator, as shown and described.

(22) **Filed:** **Sep. 24, 2002**

DESCRIPTION

(51) **LOC (7) Cl.** **15-07**

(52) **U.S. Cl.** **D15/81**

(58) **Field of Search** D15/79-91; 62/297,
62/228.1, 236, 331, 457.4, 457.9, 457.1;
312/236, 467, 278

FIG. 1 is a front elevational view of a mini size solid state refrigerator in accordance with my invention thereof;
FIG. 2 is a rear elevational view thereof;
FIG. 3 is a top elevational view thereof;
FIG. 4 is a bottom elevational view thereof;
FIG. 5 is a left side elevational view thereof;
FIG. 6 is a right side elevational view thereof;
FIG. 7 is a left side perspective view thereof; and,
FIG. 8 is a right side perspective view of a mini size solid state refrigerator.

(56) **References Cited**

U.S. PATENT DOCUMENTS

2,522,623 A * 9/1950 Likes et al. 62/297
D256,587 S * 8/1980 Tatsumi D15/83
D285,692 S * 9/1986 Albiez D15/81

1 Claim, 2 Drawing Sheets

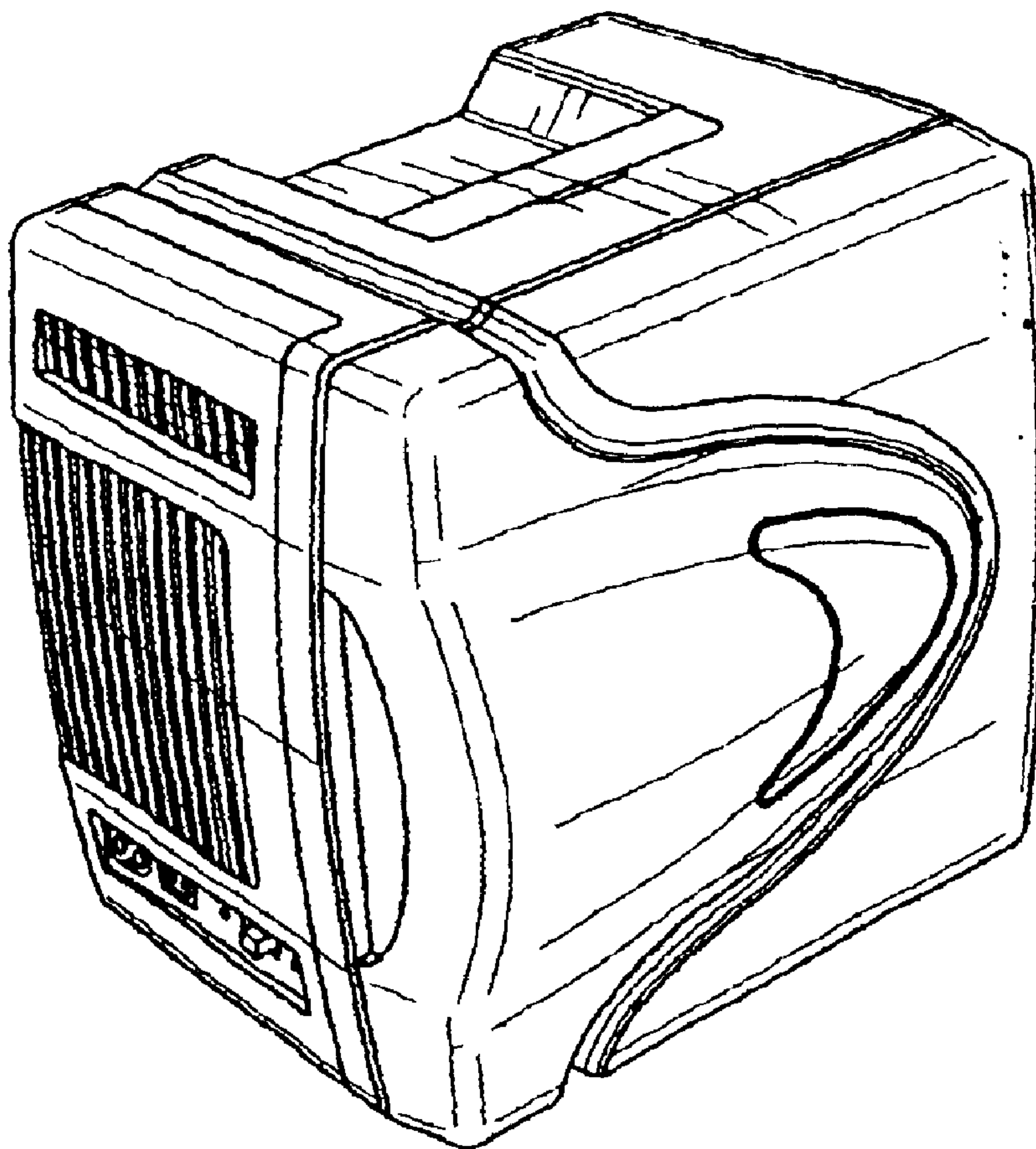

FIG.1

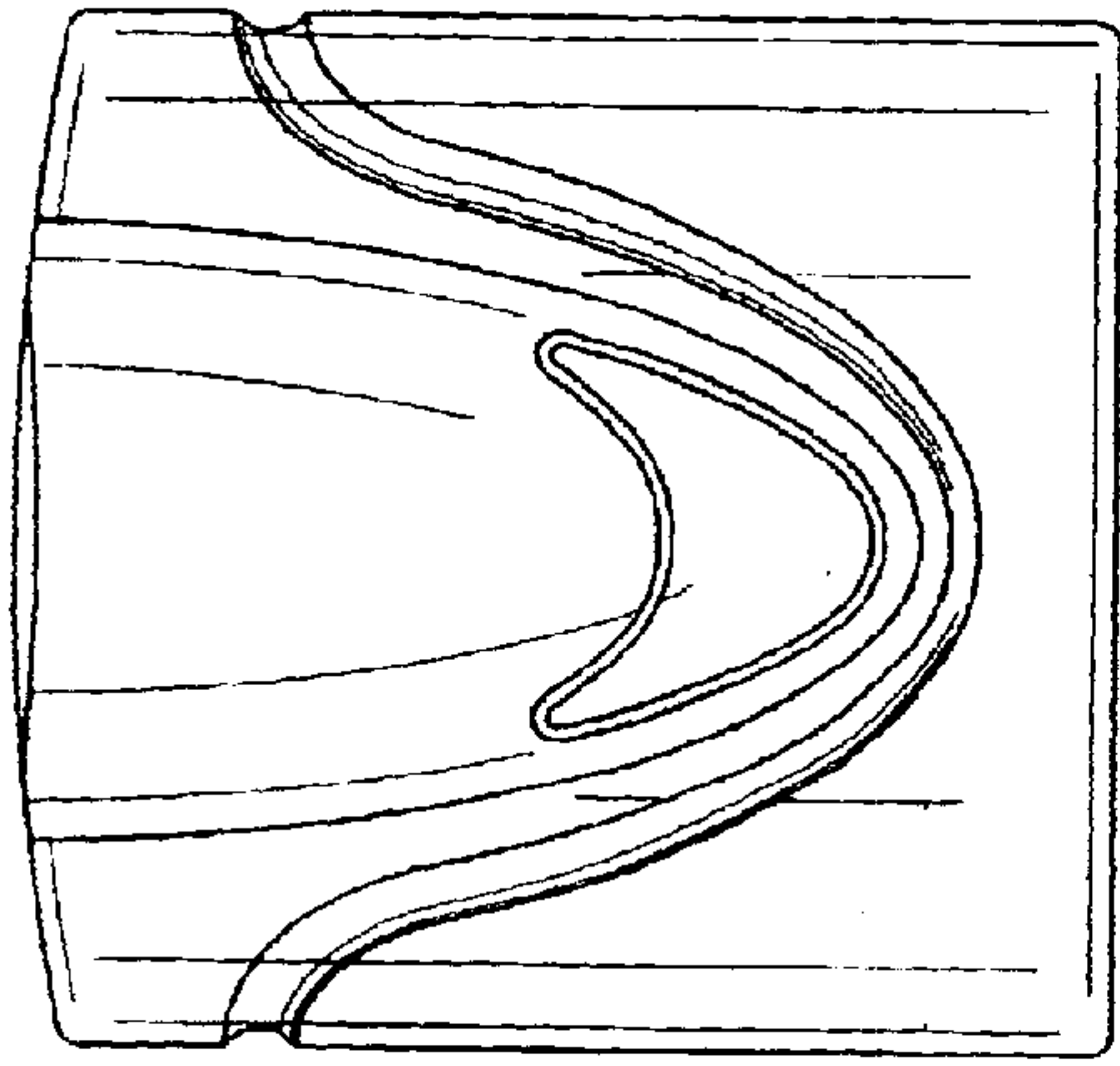

FIG.2

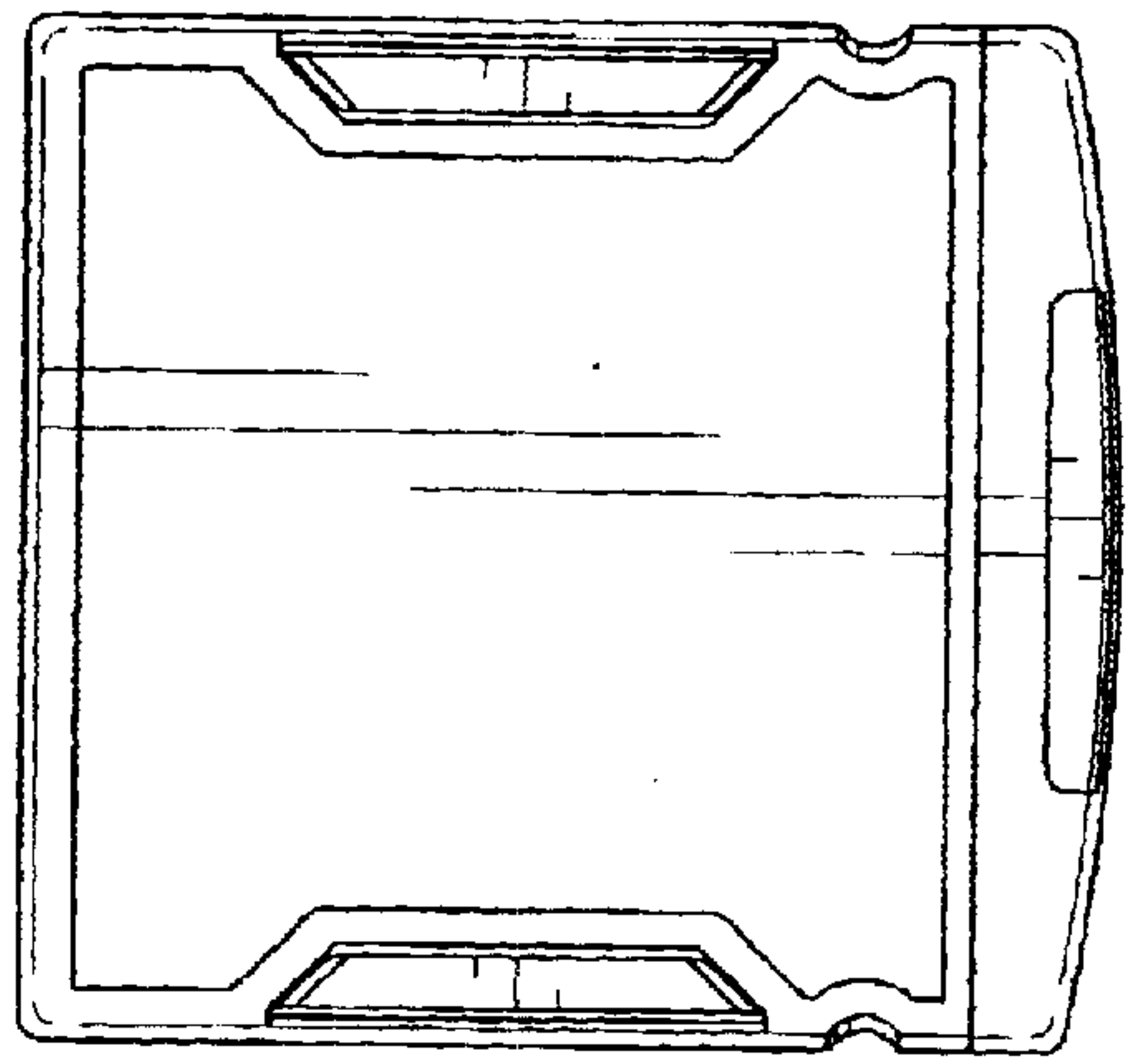

FIG.3

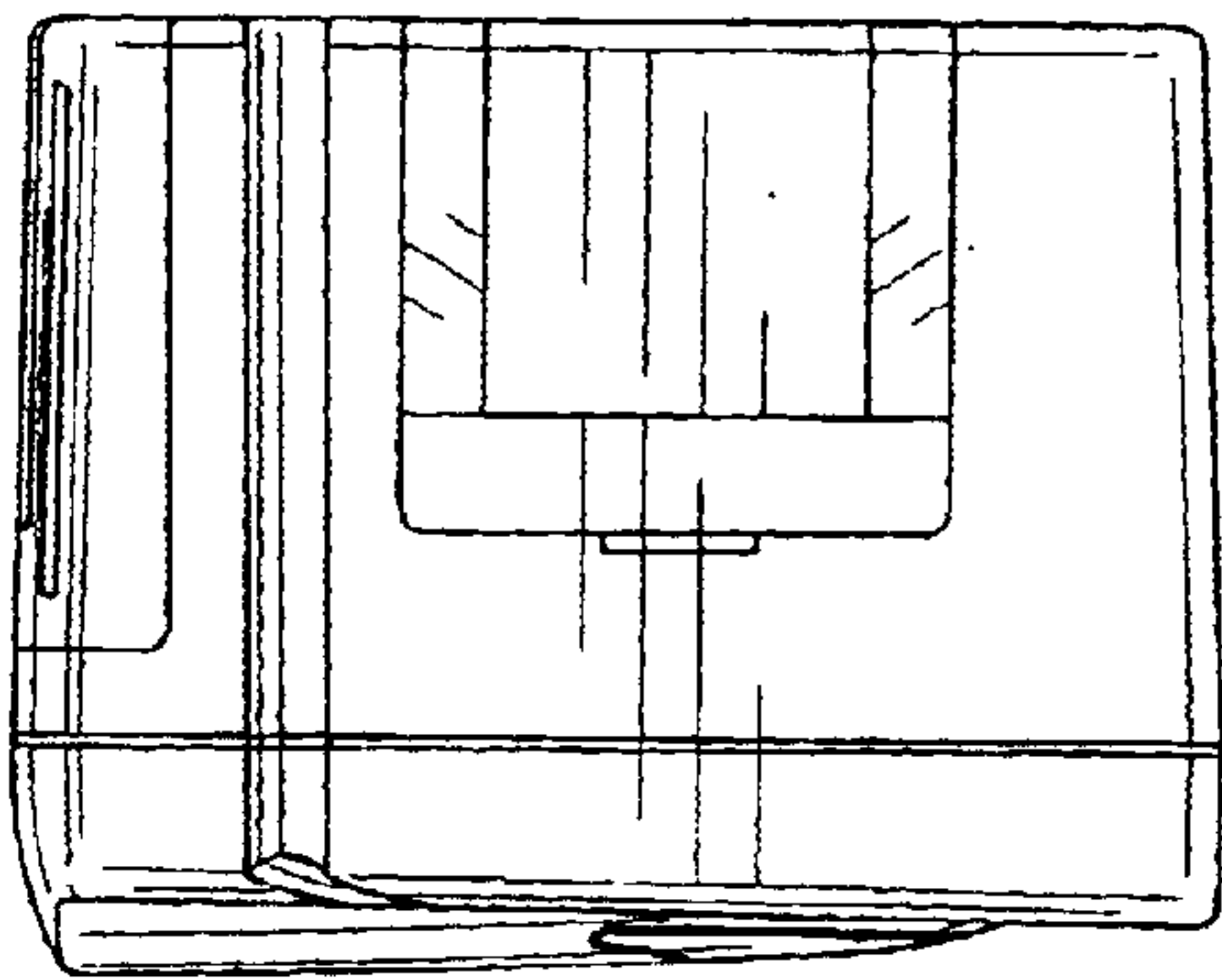

FIG.4

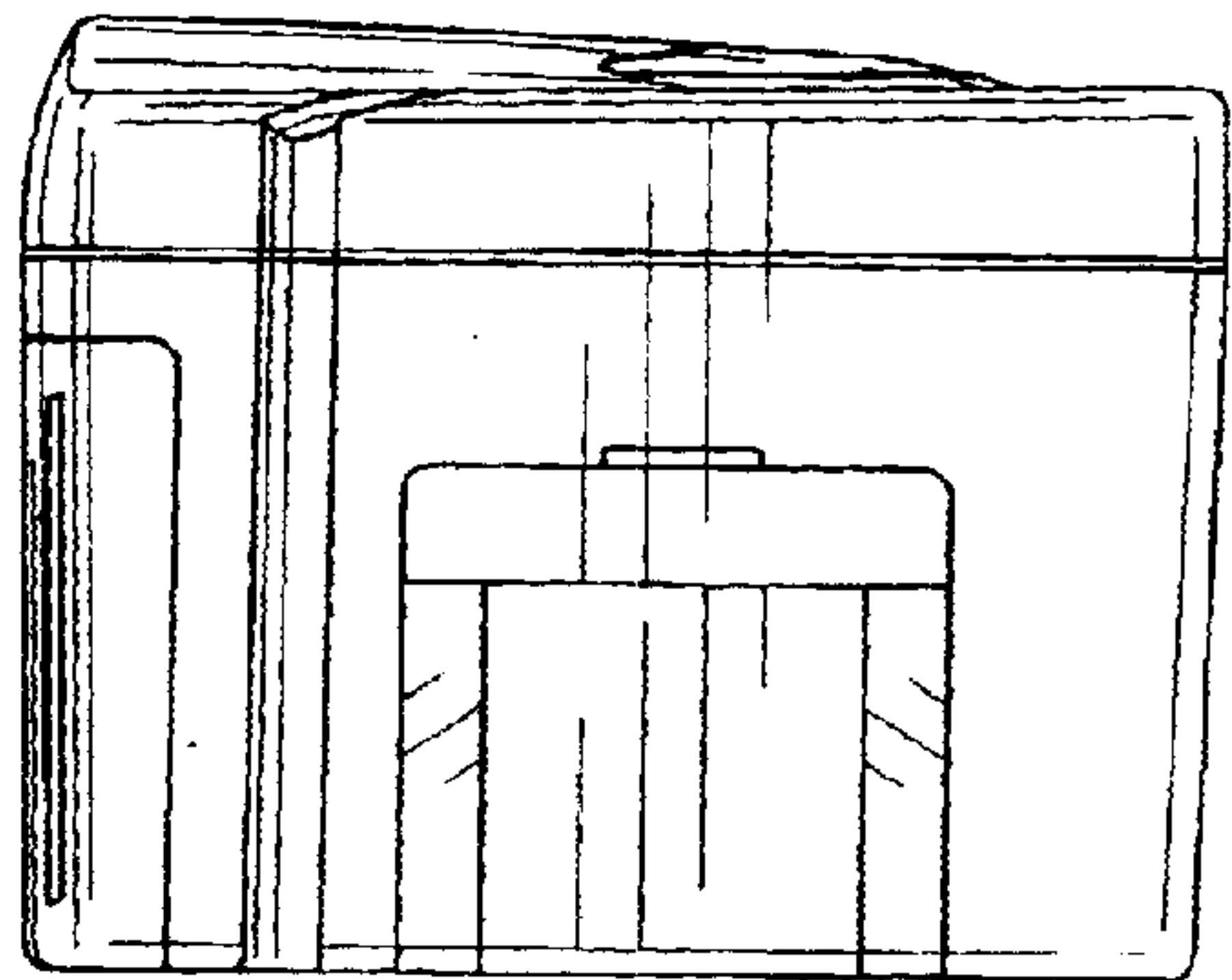

FIG.5

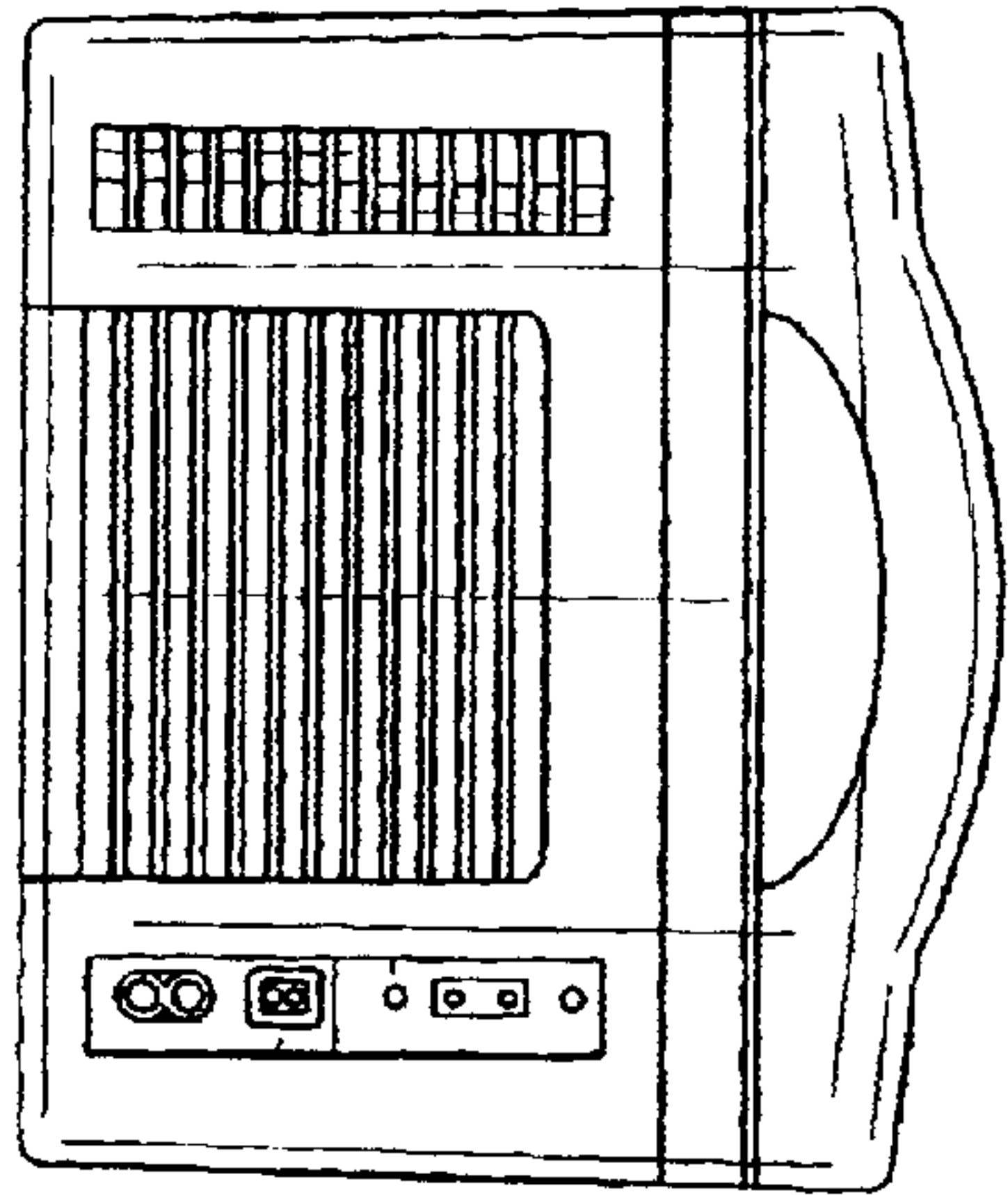

FIG.6

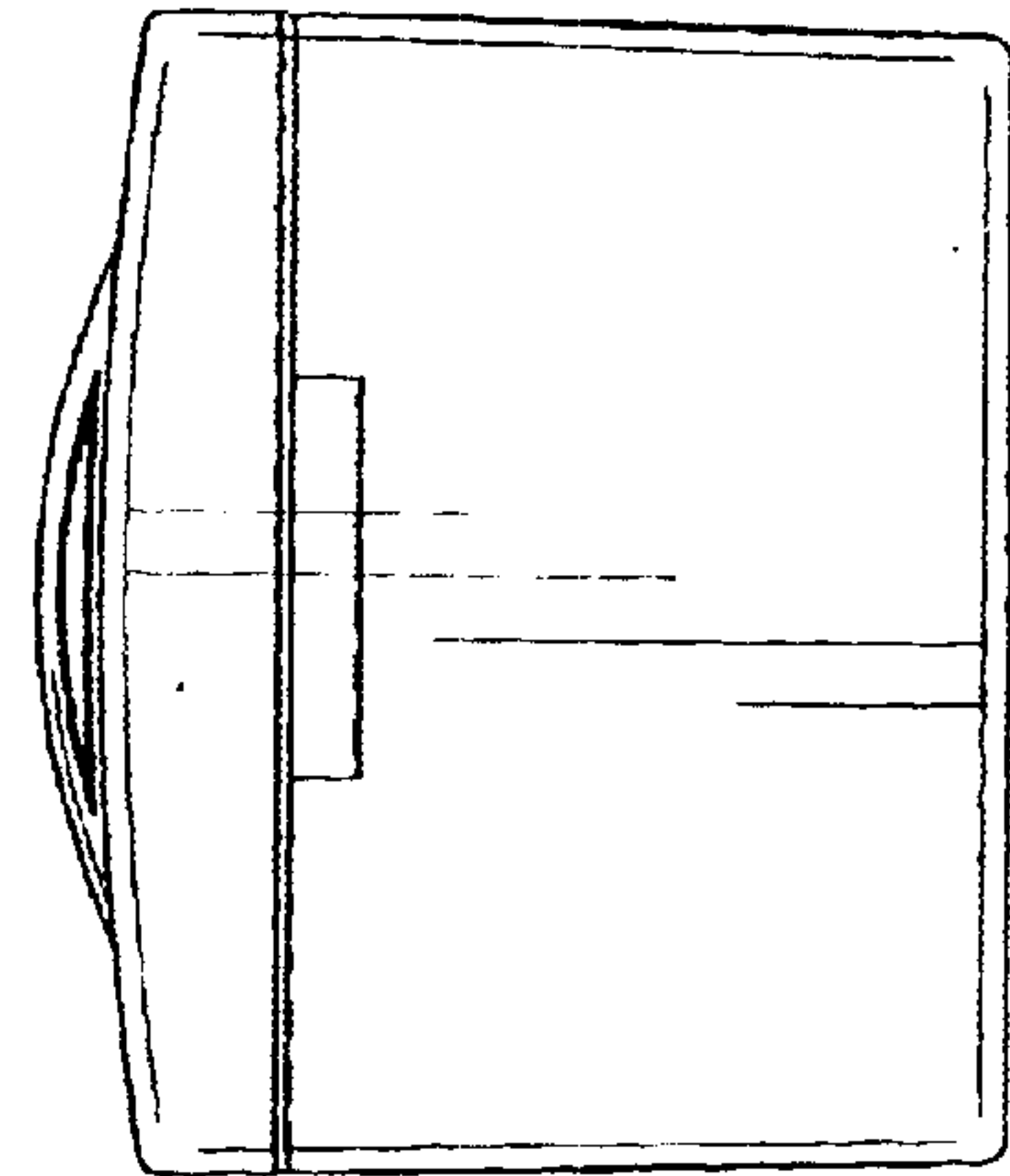

FIG.7

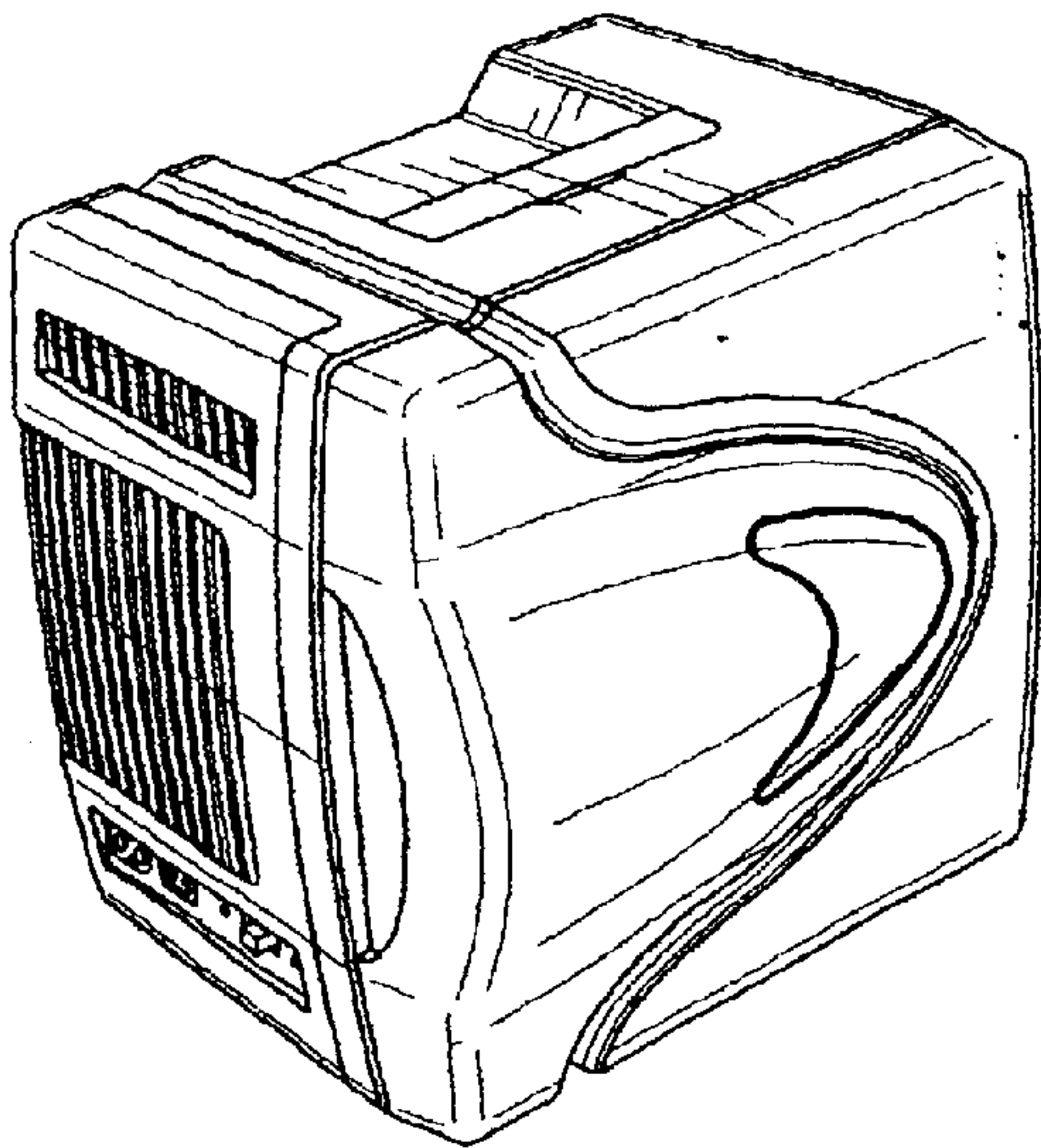

FIG.8

