



US00D481739S

(12) **United States Design Patent**
Iwai

(10) **Patent No.:** **US D481,739 S**

(45) **Date of Patent:** **** Nov. 4, 2003**

(54) **SEWING MACHINE**

D430,886 S * 9/2000 Yamamoto D15/69
D450,720 S * 11/2001 Kuroki D15/69

(75) Inventor: **Nobuyuki Iwai**, Aichi-ken (JP)

* cited by examiner

(73) Assignee: **Brother Industries, Limited**, Nagoya (JP)

Primary Examiner—Mitchell Siegel
(74) *Attorney, Agent, or Firm*—Oliff & Berridge, PLC

(**) Term: **14 Years**

(57) **CLAIM**

(21) Appl. No.: **29/169,818**

The ornamental design for a sewing machine, as shown and described.

(22) Filed: **Oct. 28, 2002**

DESCRIPTION

(30) **Foreign Application Priority Data**

May 9, 2002 (JP) 2002-012263

FIG. 1 is a front view of a sewing machine;
FIG. 2 is a rear view thereof;
FIG. 3 is a left-side view thereof;
FIG. 4 is a right-side view thereof;
FIG. 5 is a top view thereof;
FIG. 6 is a bottom view thereof;
FIG. 7 is a perspective view thereof; and,
FIG. 8 is a front view showing a cover in an open position.
The broken line showing defines the bounds of the claimed design but does not form part of the claimed design.

(51) **LOC (7) Cl.** **15-06**

(52) **U.S. Cl.** **D15/69**

(58) **Field of Search** D15/66-76; 112/217.1-217.4,
112/258-261

(56) **References Cited**

U.S. PATENT DOCUMENTS

D382,280 S * 8/1997 Kato et al. D15/69

1 Claim, 4 Drawing Sheets

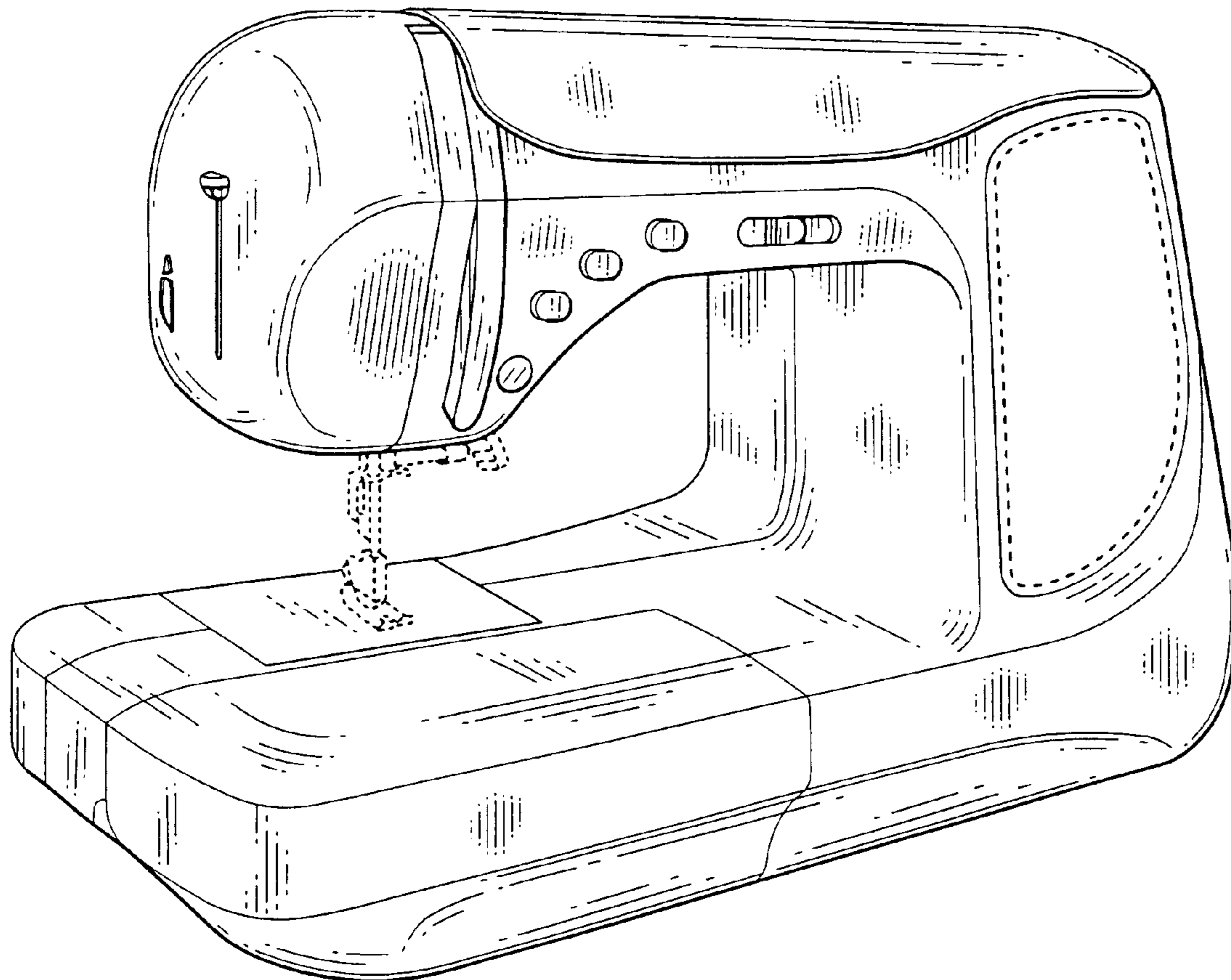

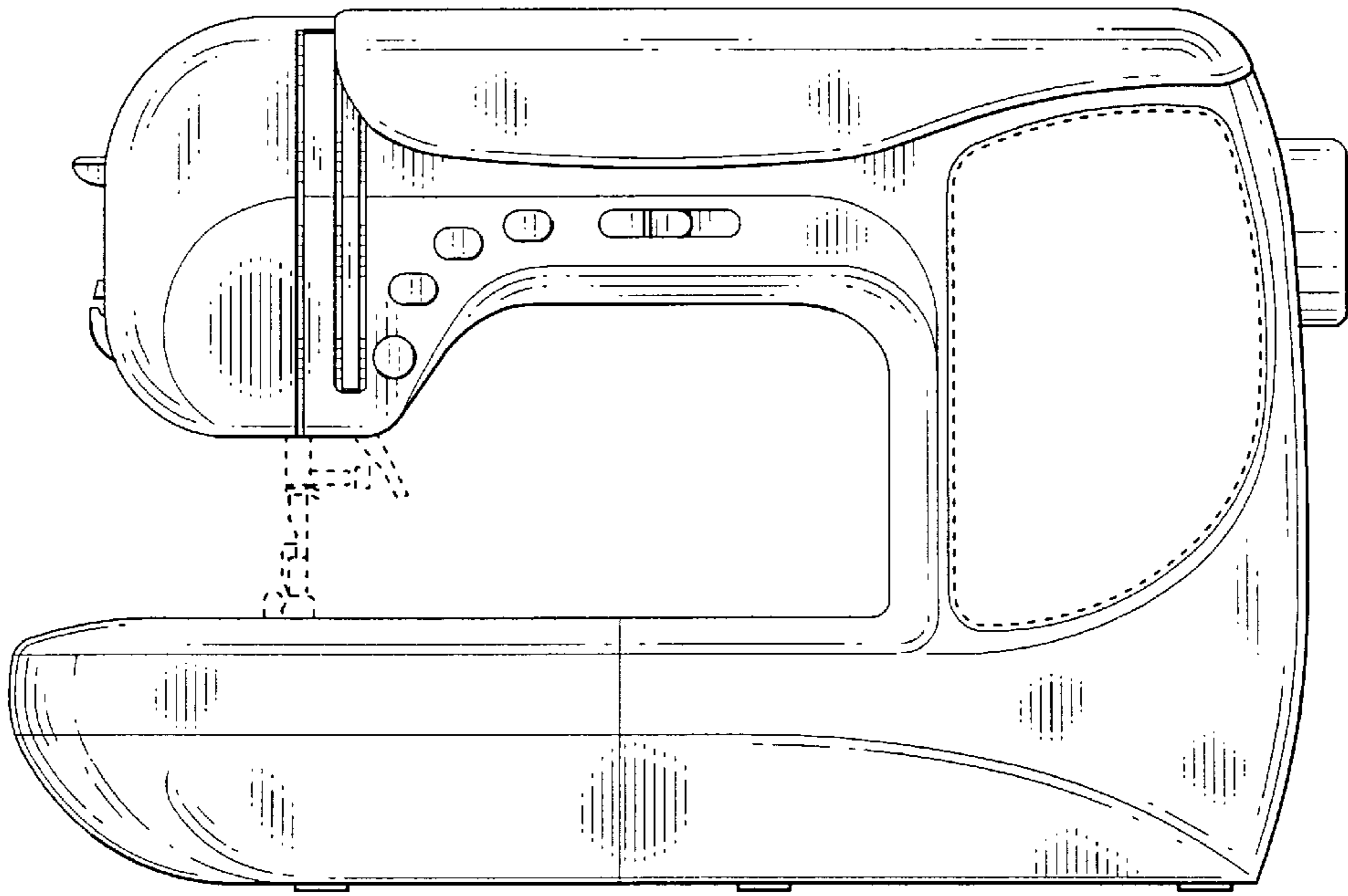

Fig. 1

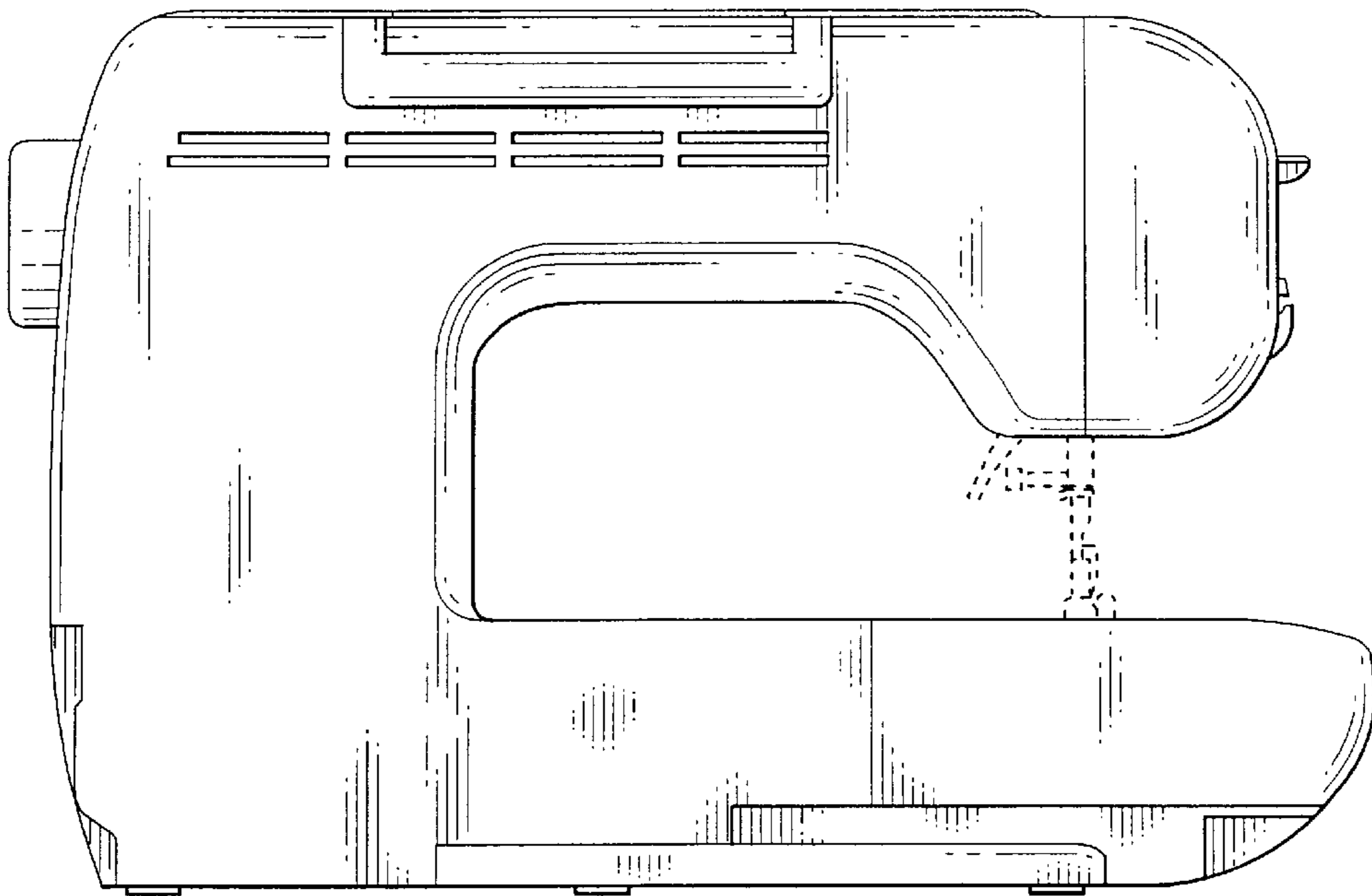

Fig. 2

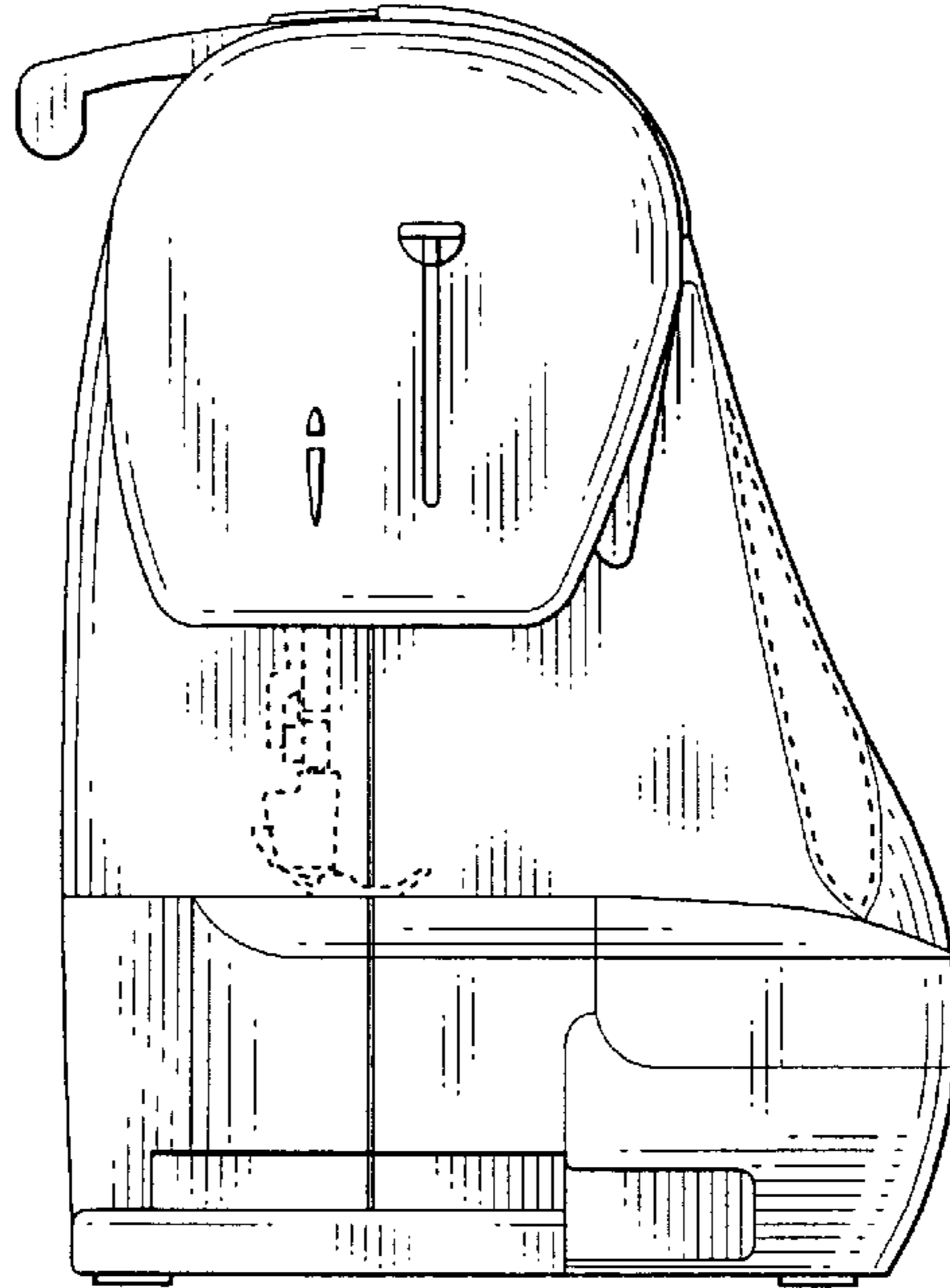

Fig. 3

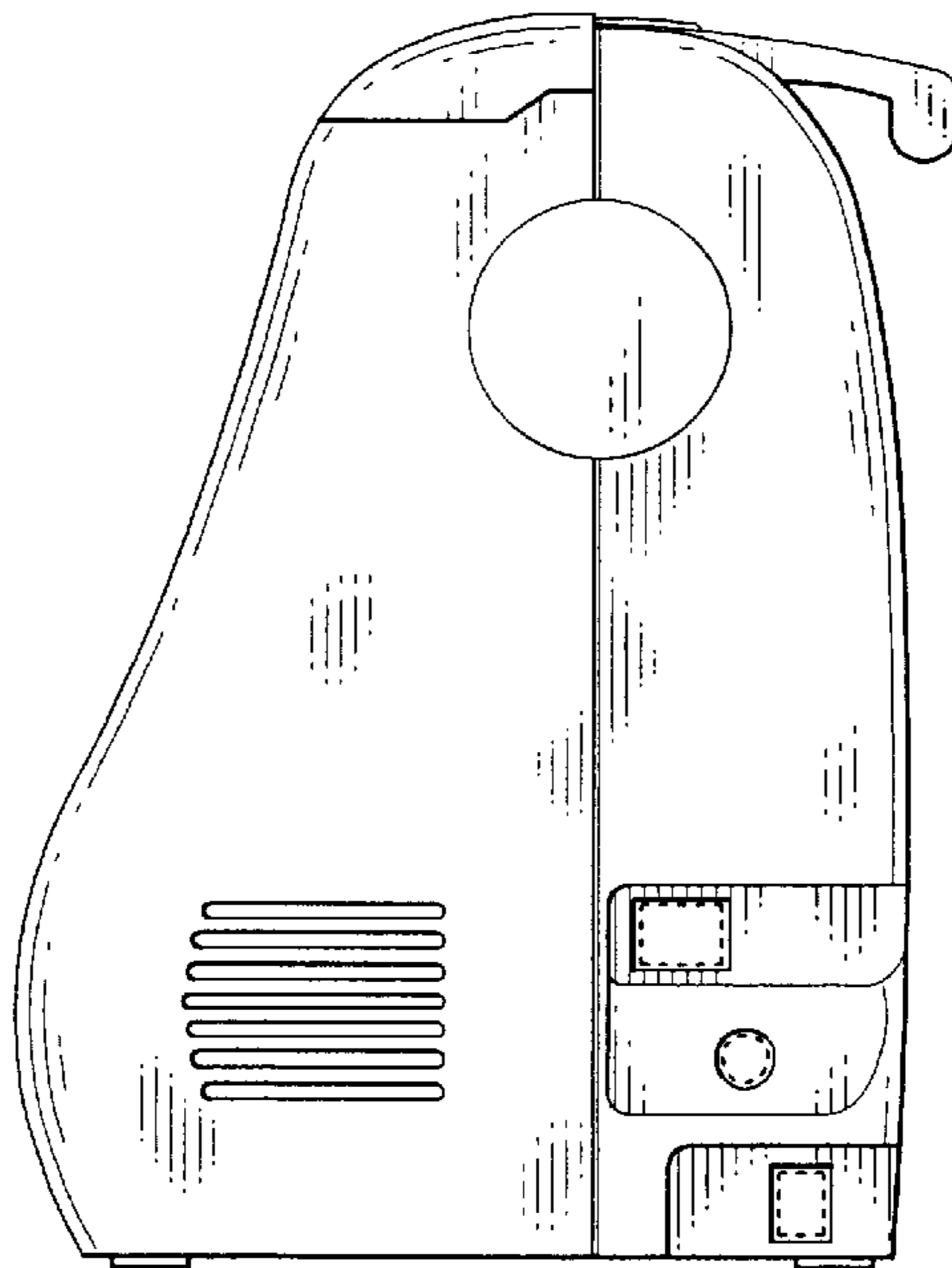

Fig. 4

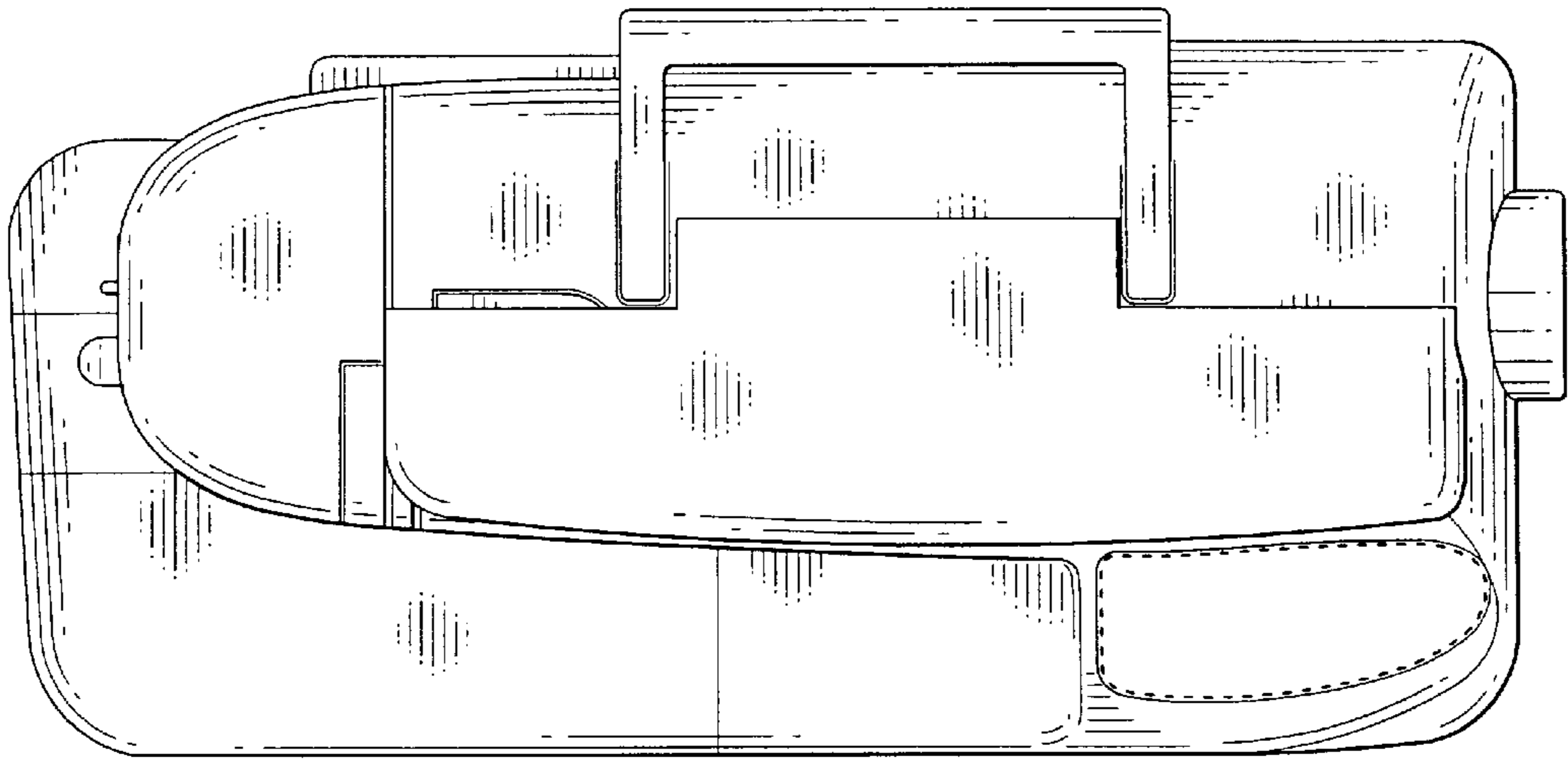

Fig. 5

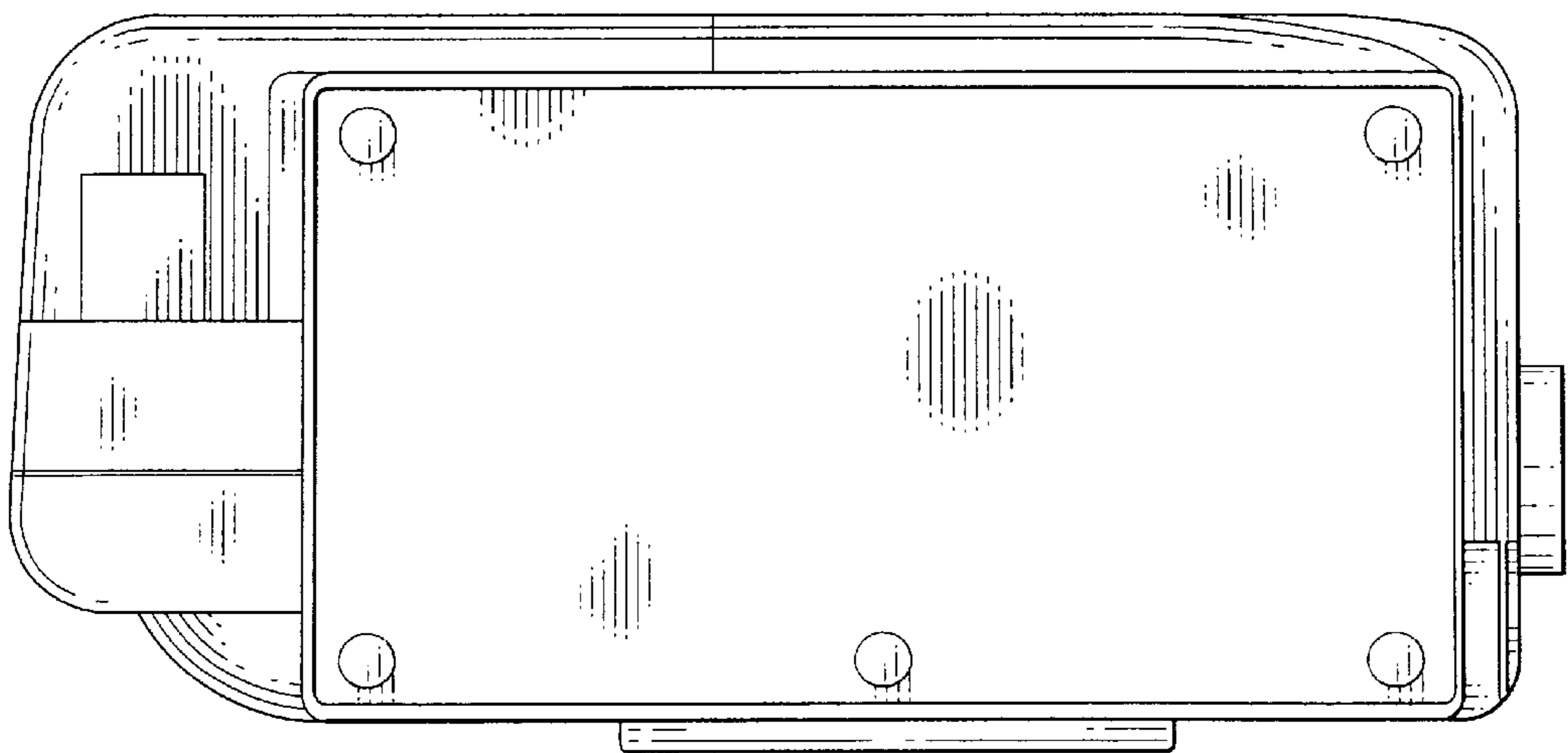

Fig. 6

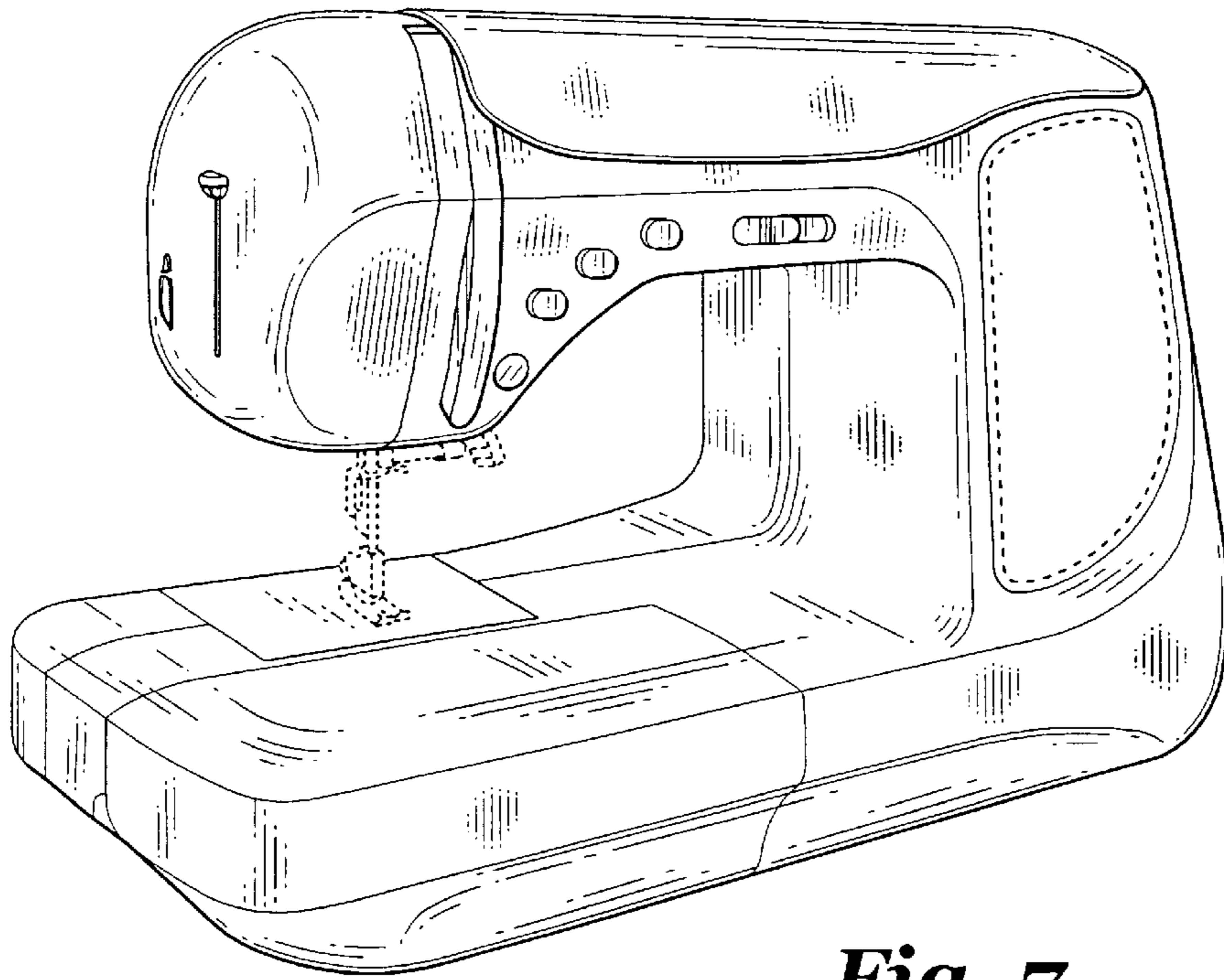

Fig. 7

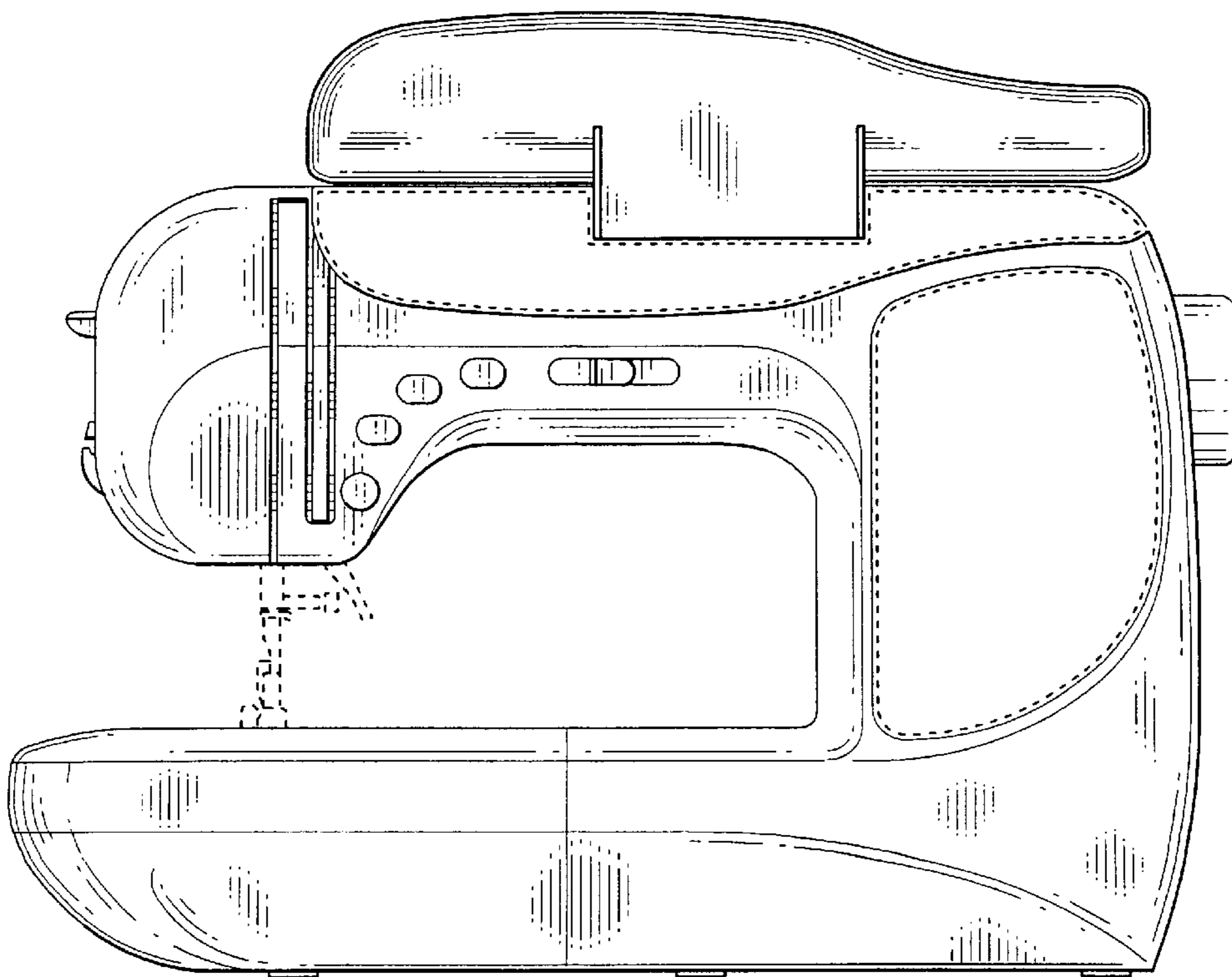

Fig. 8