



US00D481727S

(12) **United States Design Patent**  
**Olson et al.**

(10) **Patent No.:** **US D481,727 S**

(45) **Date of Patent:** **\*\* Nov. 4, 2003**

(54) **LIQUID CRYSTAL DISPLAY**

(75) Inventors: **Mark H. Olson**, Sunnyvale, CA (US);  
**Jeff Wyatt**, Sunnyvale, CA (US);  
**Michael Voege**, Sunnyvale, CA (US);  
**Luke Williams**, Sunnyvlae, CA (US);  
**Garth Gibby**, Sunnyvale, CA (US);  
**Ethan Imboden**, Sunnyvale, CA (US);  
**Ana Reza**, Sunnyvale, CA (US)

(73) Assignee: **Hannspree, Inc.** (TW)

(\*\*) Term: **14 Years**

(21) Appl. No.: **29/169,772**

(22) Filed: **Oct. 25, 2002**

(51) **LOC (7) Cl.** ..... **14-02**

(52) **U.S. Cl.** ..... **D14/375**

(58) **Field of Search** ..... D14/371-382,  
D14/125-129, 336; 248/917-924; 341/12;  
345/104, 156, 168, 173, 87; 348/180, 184,  
325, 739; 349/1, 2, 11, 62

(56) **References Cited**

**U.S. PATENT DOCUMENTS**

D290,702 S \* 7/1987 Stern et al. .... D14/375

D314,564 S \* 2/1991 Grundstrom et al. .... D14/375  
D323,324 S \* 1/1992 Suda ..... D14/125  
D355,170 S \* 2/1995 Mizusugi et al. .... D14/336  
D387,040 S \* 12/1997 Iino ..... D14/375  
D408,383 S \* 4/1999 Carter et al. .... D14/374

\* cited by examiner

*Primary Examiner*—Freda Nunn

(74) *Attorney, Agent, or Firm*—Merchant & Gould LLC

(57) **CLAIM**

The ornamental design for a liquid crystal display, as shown and described.

**DESCRIPTION**

FIG. 1 is a front perspective view thereof;  
FIG. 2 is a right side elevational view thereof;  
FIG. 3 is a top plan view thereof;  
FIG. 4 is a front elevational view thereof;  
FIG. 5 is a bottom plane view thereof;  
FIG. 6 is a left side elevational view thereof;  
FIG. 7 is a rear elevational view thereof; and,  
FIG. 8 is a front perspective view thereof, with holder being in a closed position.

**1 Claim, 8 Drawing Sheets**

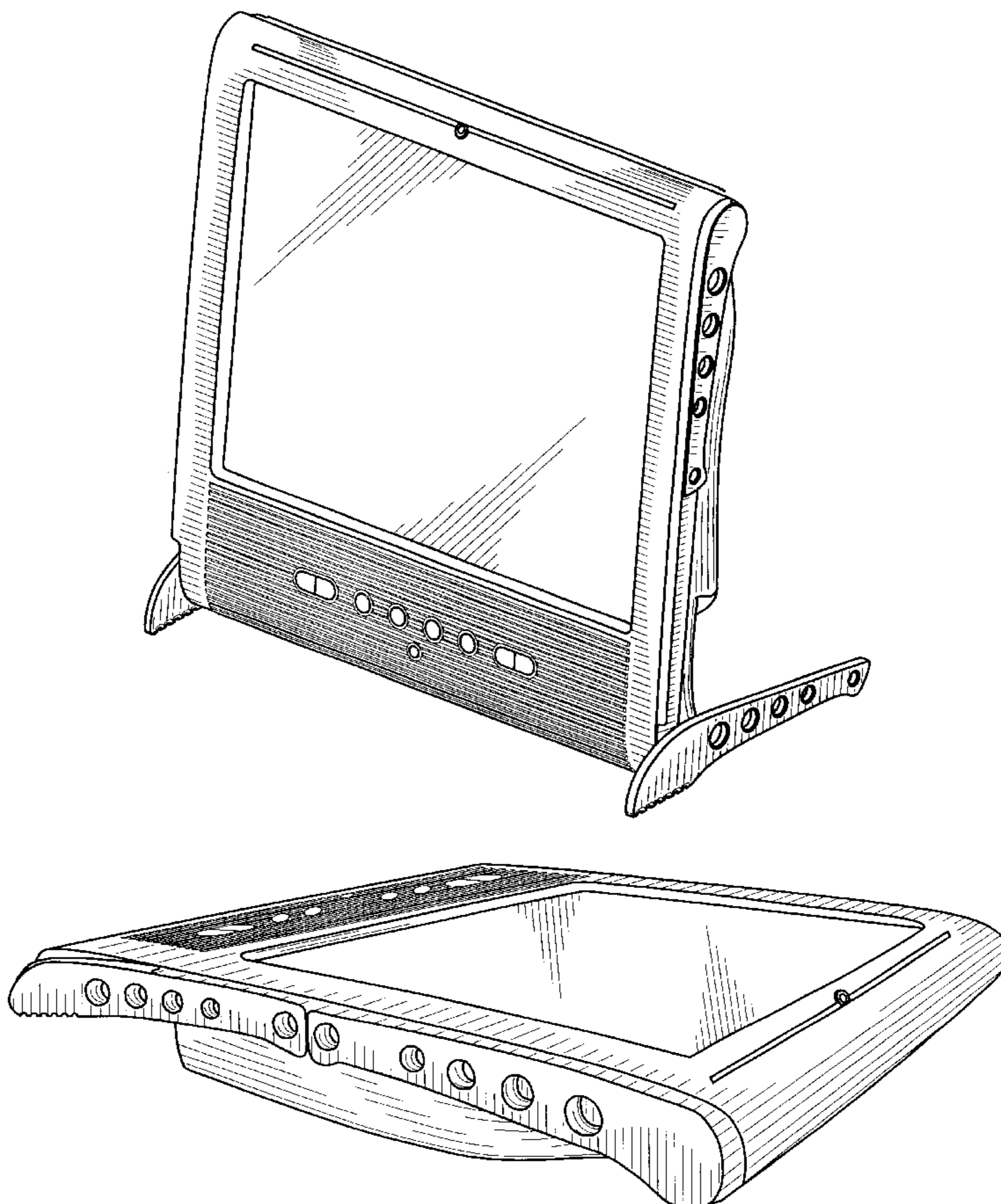

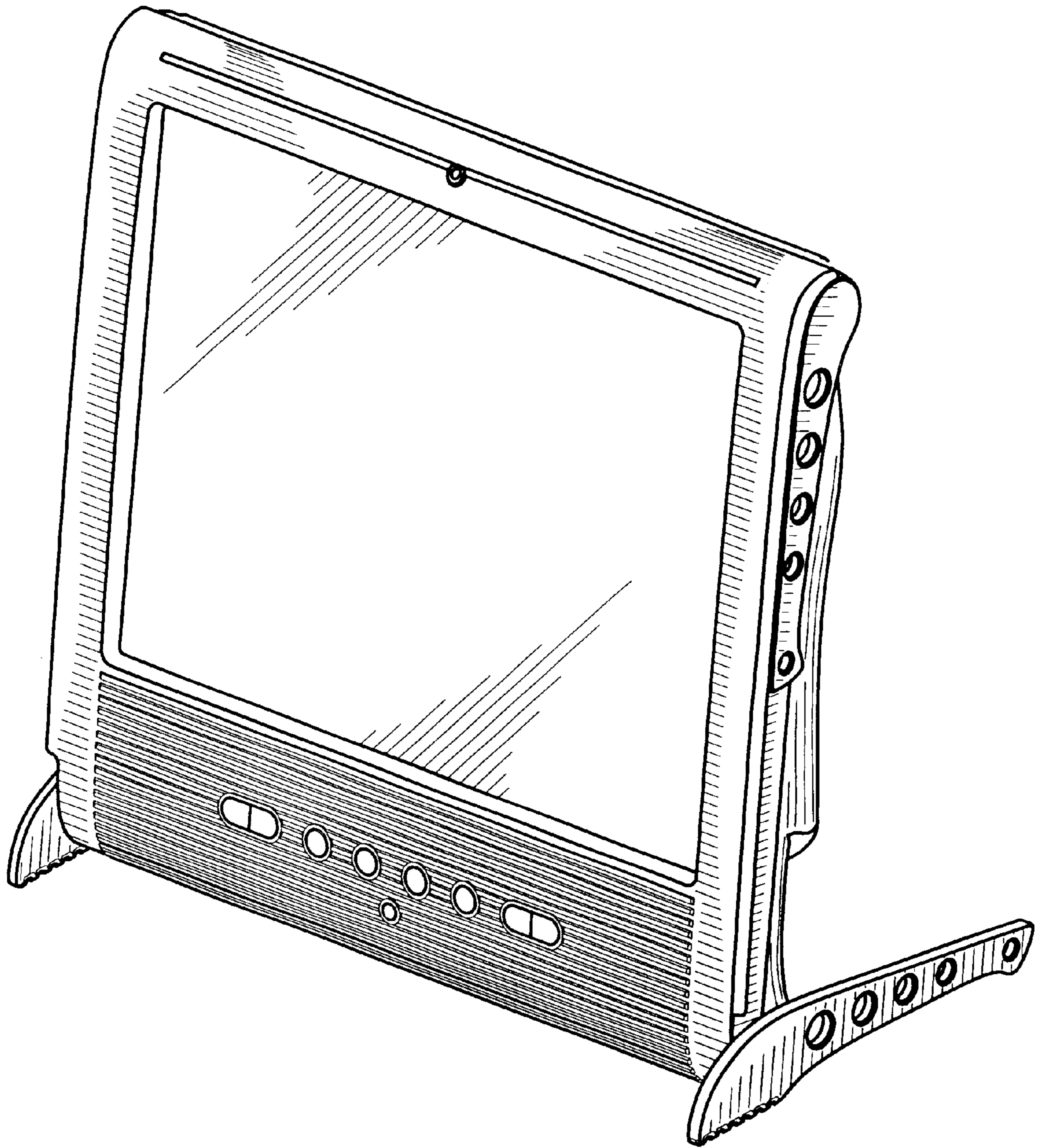

Fig. 1

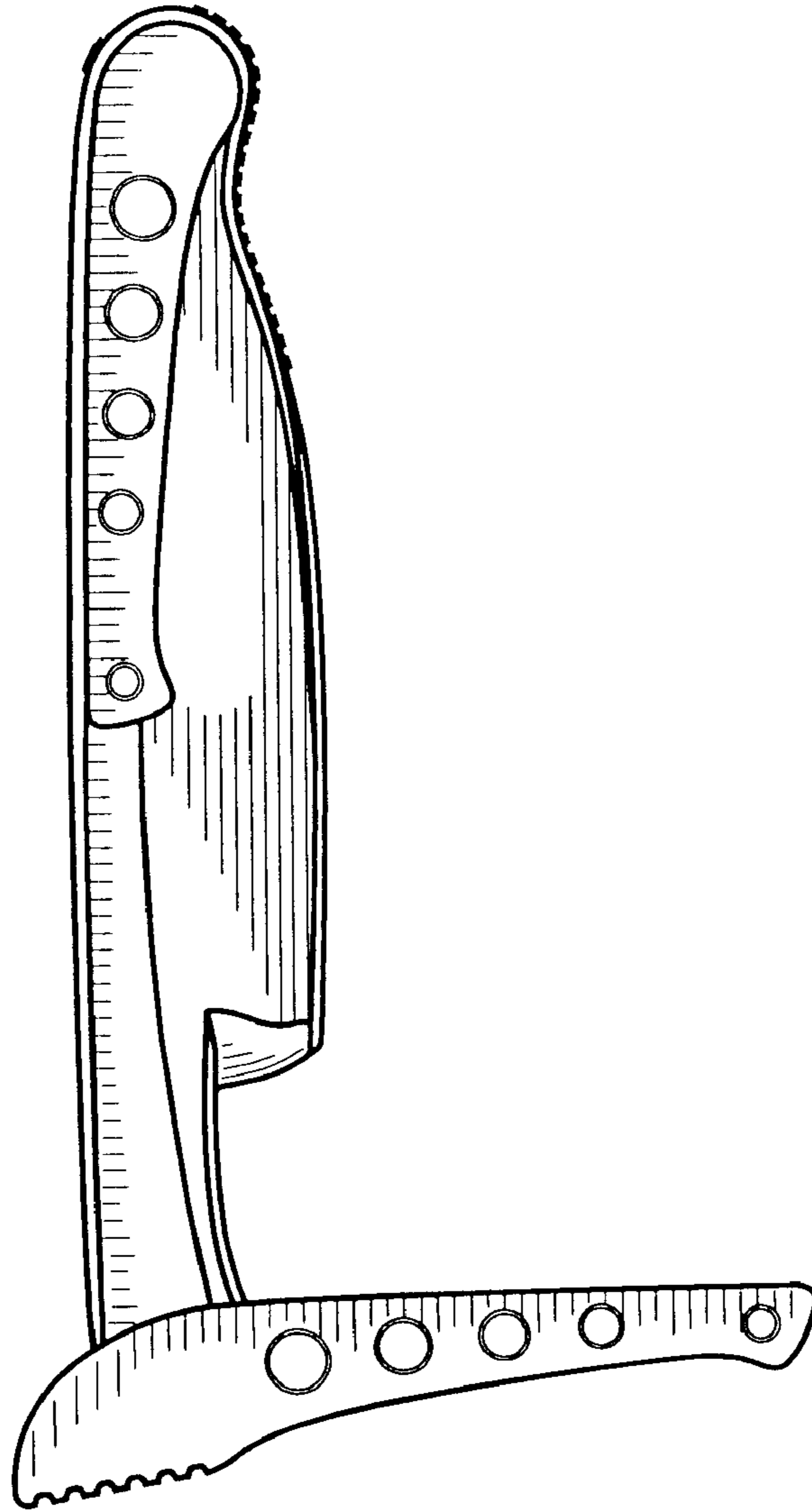

Fig. 2

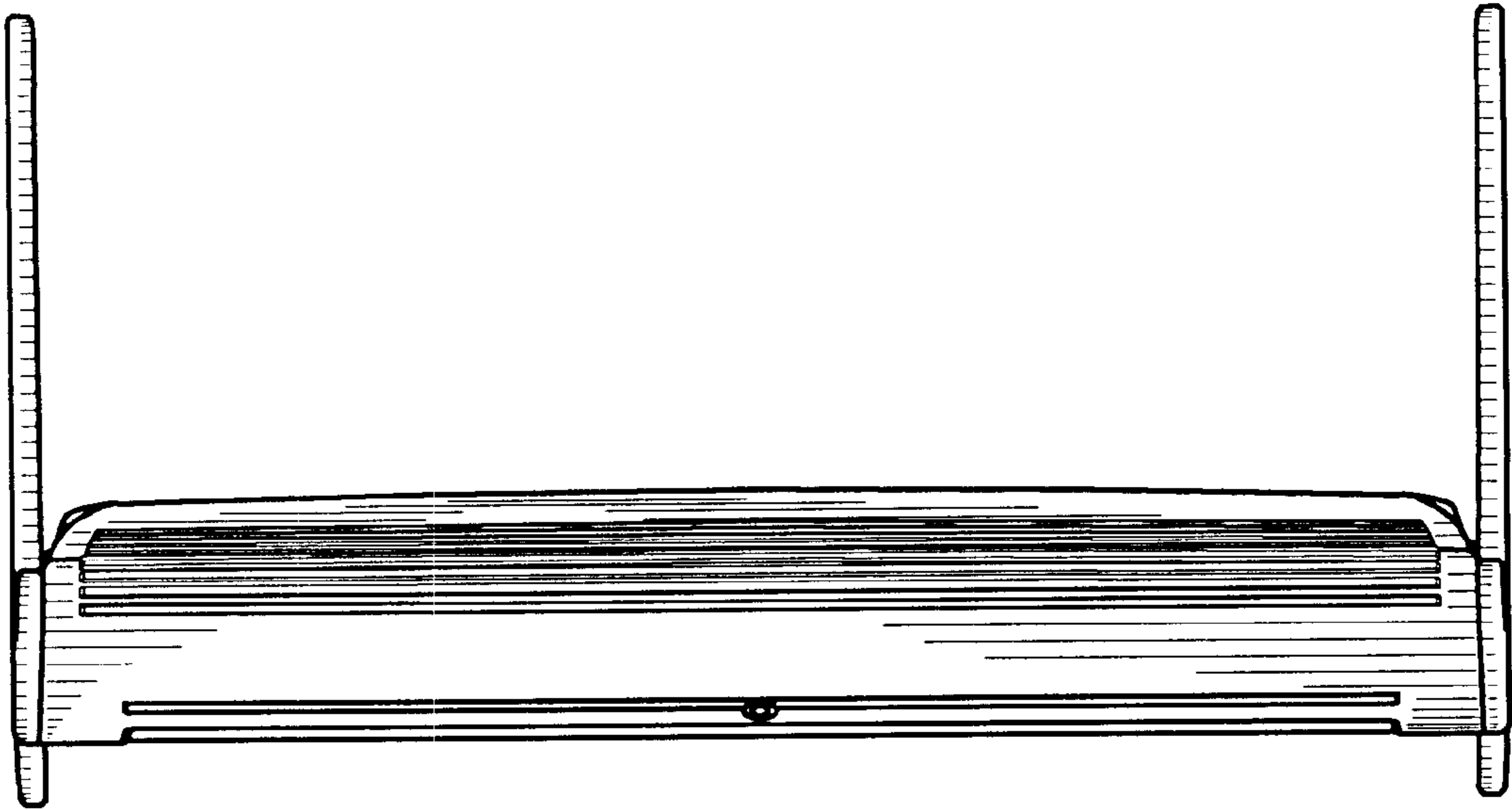

Fig. 3

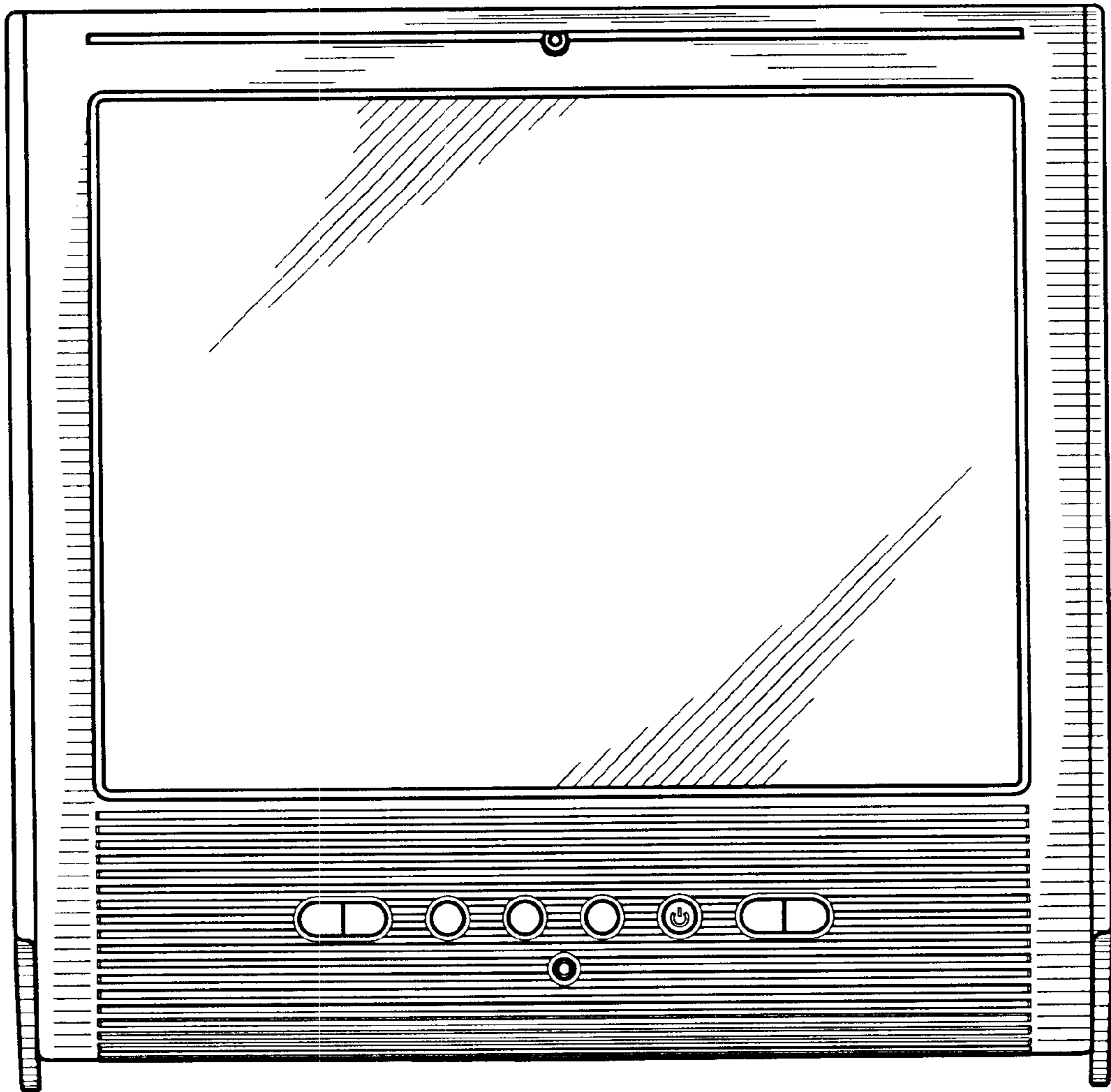

Fig. 4

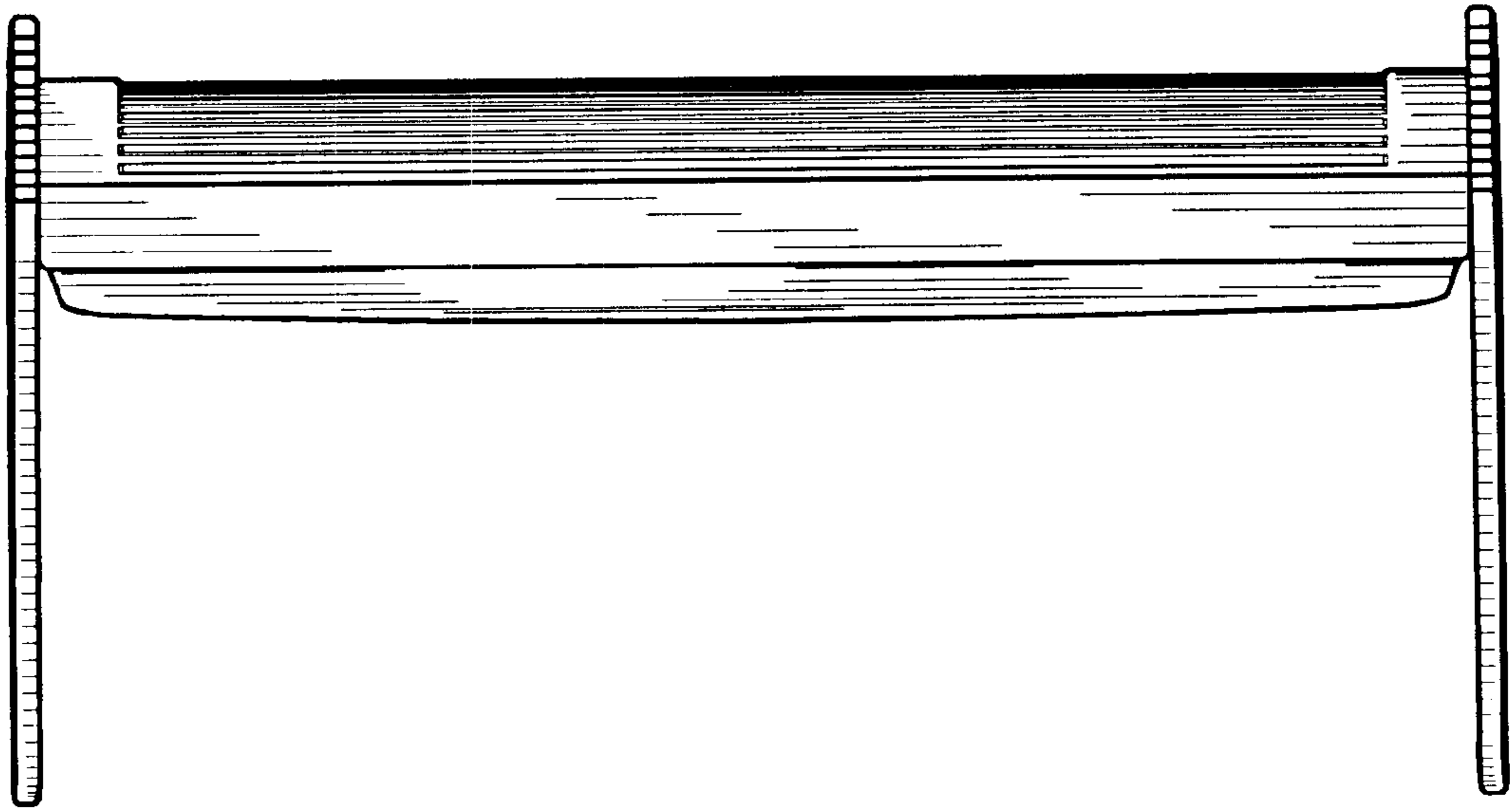

Fig. 5

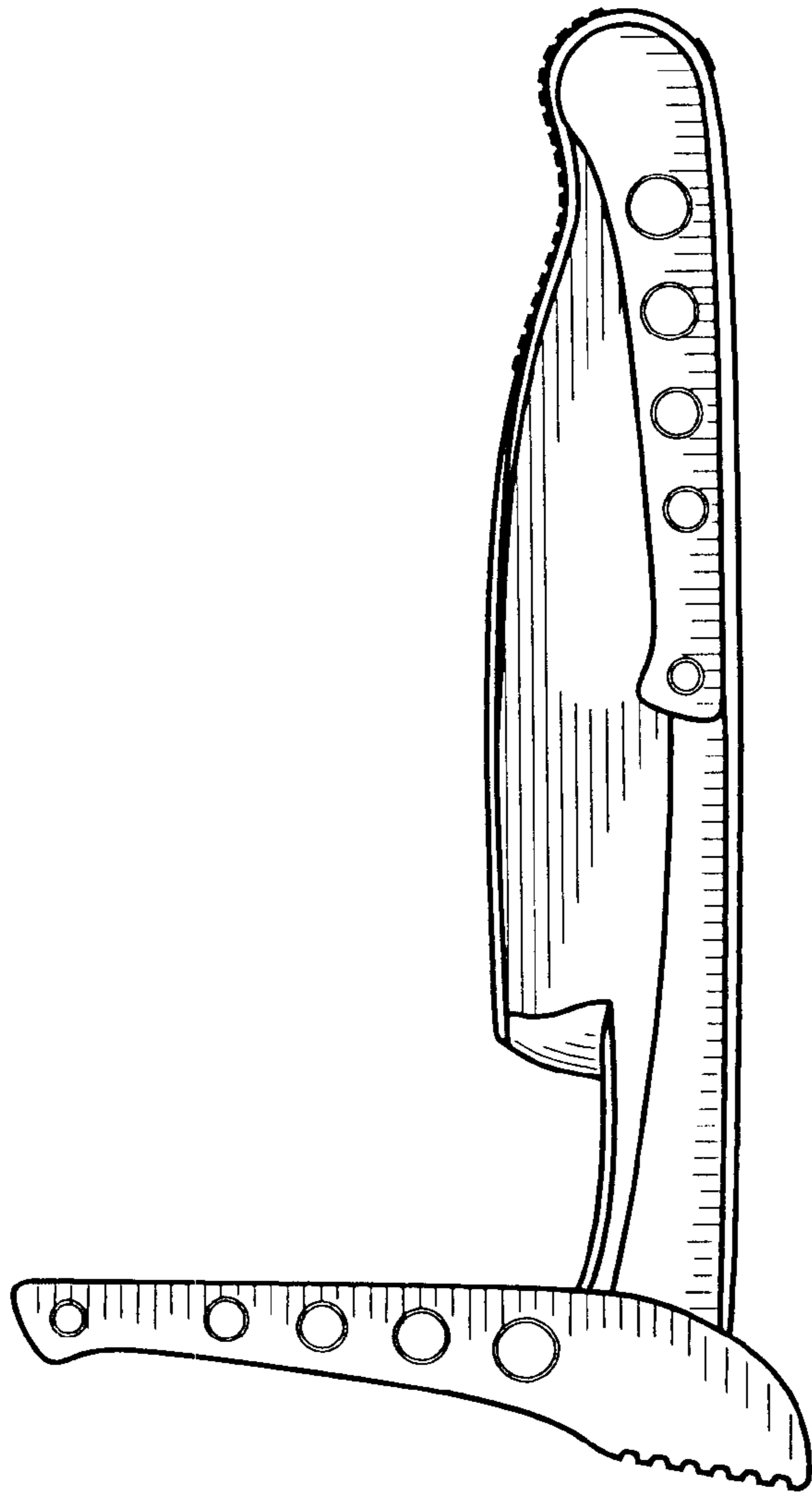

Fig. 6

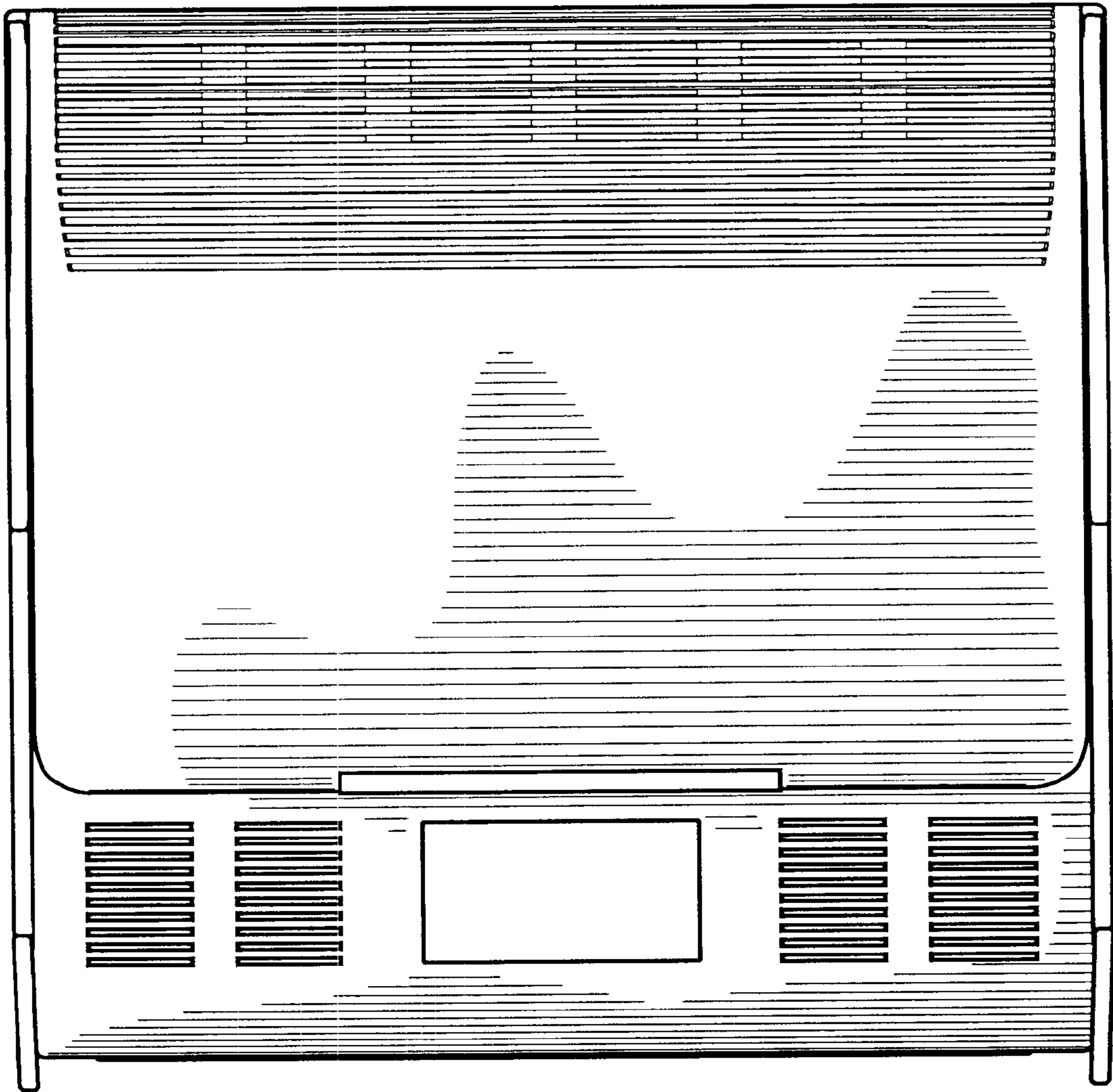

Fig. 7



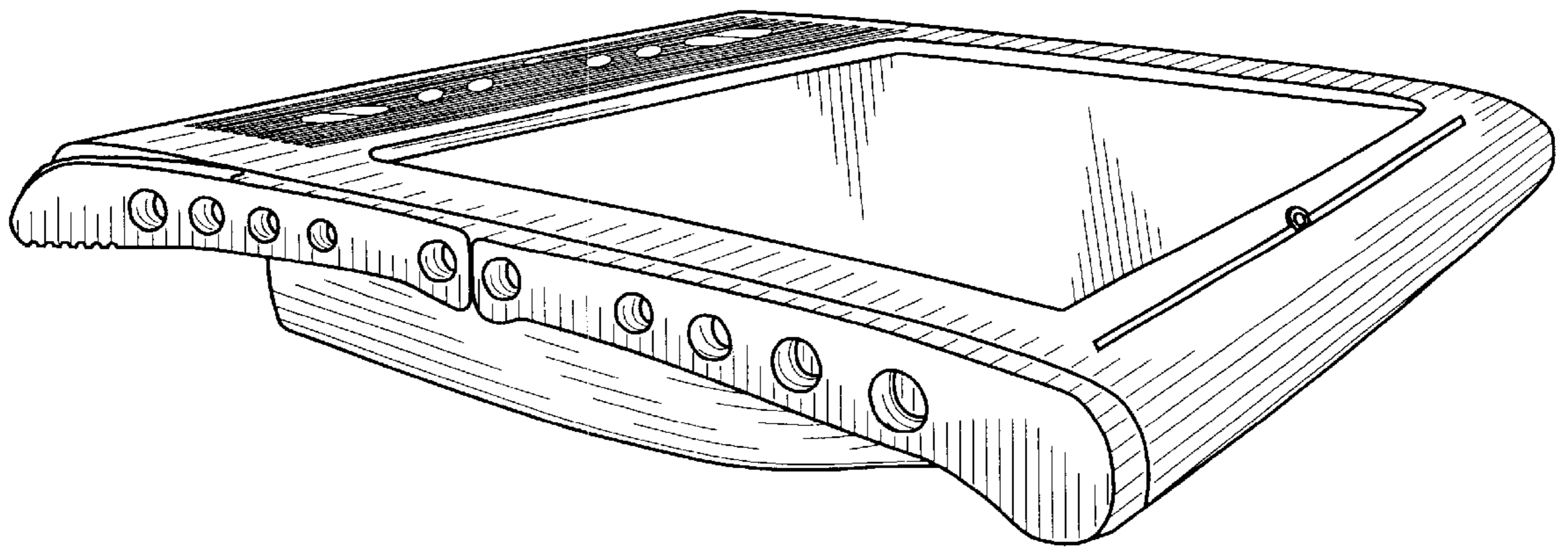

Fig. 8