



US00D481684S

(12) **United States Design Patent**
Bomar

(10) **Patent No.:** **US D481,684 S**

(45) **Date of Patent:** **** Nov. 4, 2003**

(54) **BONDING TAB**

(75) Inventor: **Richard Bomar**, Memphis, TN (US)

(73) Assignee: **Thomas & Betts International, Inc.**,
Sparks, NV (US)

(**) Term: **14 Years**

(21) Appl. No.: **29/161,079**

(22) Filed: **May 22, 2002**

(51) **LOC (7) Cl.** **13-03**

(52) **U.S. Cl.** **D13/154**

(58) **Field of Search** 174/50, 70 R,
174/50.54; D13/154, 156; 439/71, 97, 108,
70

(56) **References Cited**

U.S. PATENT DOCUMENTS

D297,410 S	8/1988	Sachs	D8/356
6,086,386 A *	7/2000	Fjelstad et al.	439/70
6,205,660 B1 *	3/2001	Fjelstad et al.	439/71
6,283,771 B1 *	9/2001	Mitchell et al.	439/97
2002/0125029 A1 *	9/2002	Hussaini	174/50

* cited by examiner

Primary Examiner—Jennifer Rivard

(74) *Attorney, Agent, or Firm*—G. Andrew Barger

(57) **CLAIM**

The ornamental design for a bonding tab, as shown and described.

DESCRIPTION

FIG. 1 is a perspective view of the preferred bonding tab design.

FIG. 2 is a top plan view of the preferred bonding tab design.

FIG. 3 is a side elevation view of the preferred bonding tab design.

FIG. 4 is a bottom plan view of the preferred bonding tab design.

FIG. 5 is a raised side elevation view of the preferred bonding tab design.

FIG. 6 is a first end side elevation view of the preferred bonding tab design.

FIG. 7 is a second end side elevation view of the preferred bonding tab design.

FIG. 8 is a perspective view of the rectangular embodiment of the bonding tab design.

FIG. 9 is a top plan view of the rectangular embodiment of the bonding tab design.

FIG. 10 is a side elevation view of the rectangular embodiment of the bonding tab design.

FIG. 11 is a bottom plan view of the rectangular embodiment of the bonding tab design.

FIG. 12 is a raised side elevation view of the rectangular embodiment of the bonding tab design.

FIG. 13 is a first end side elevation view of the rectangular embodiment of the bonding tab design; and,

FIG. 14 is a second end side elevation view of the rectangular embodiment of the bonding tab design.

1 Claim, 4 Drawing Sheets

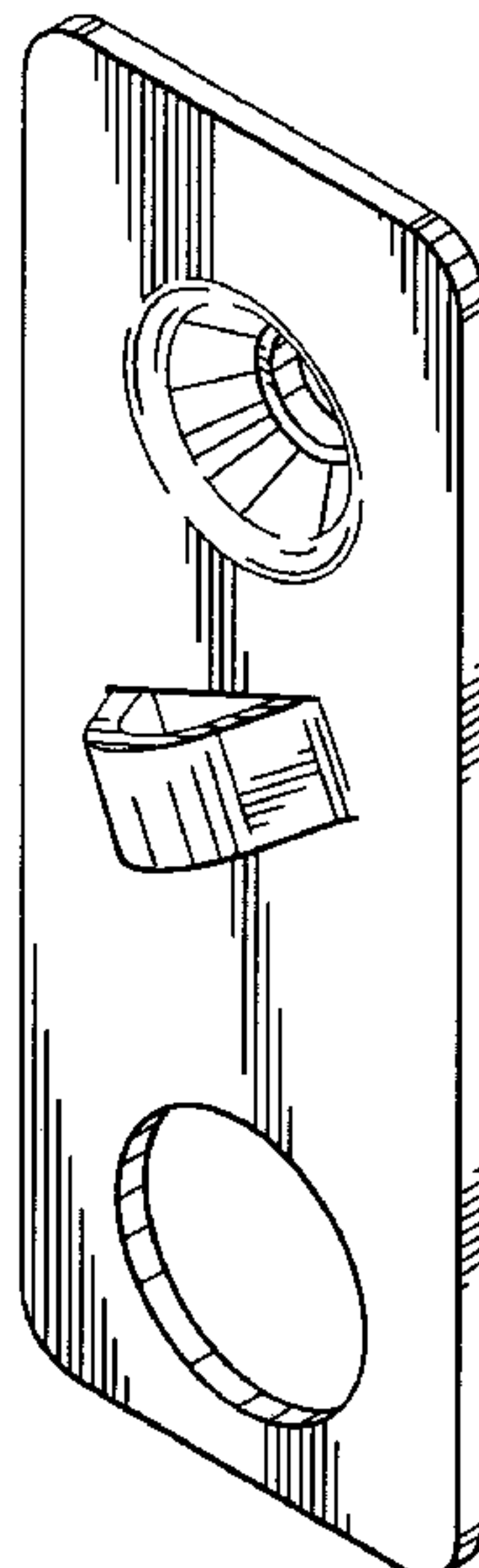
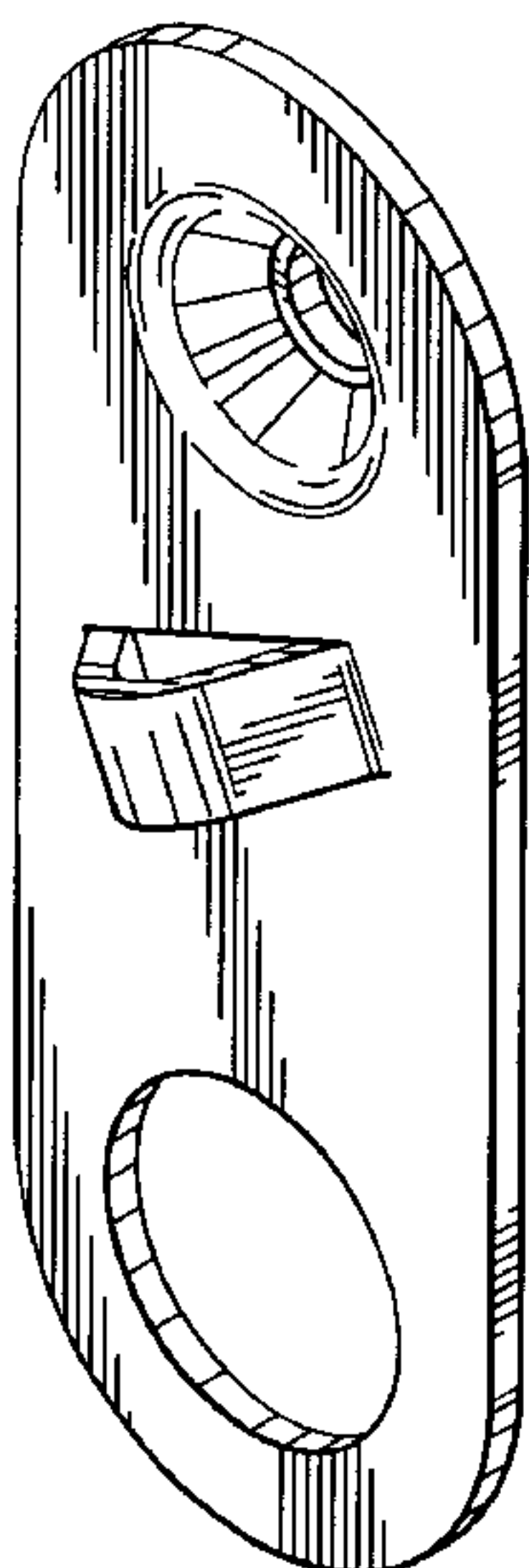

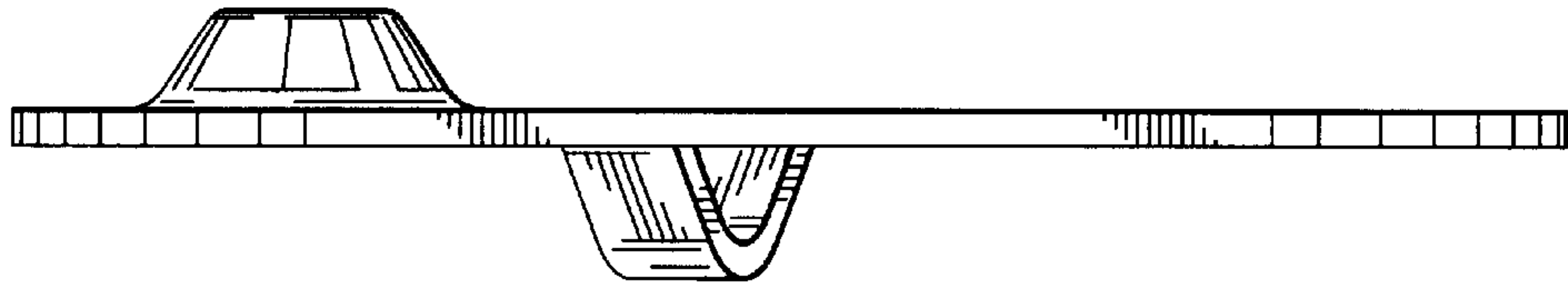

FIG. 3

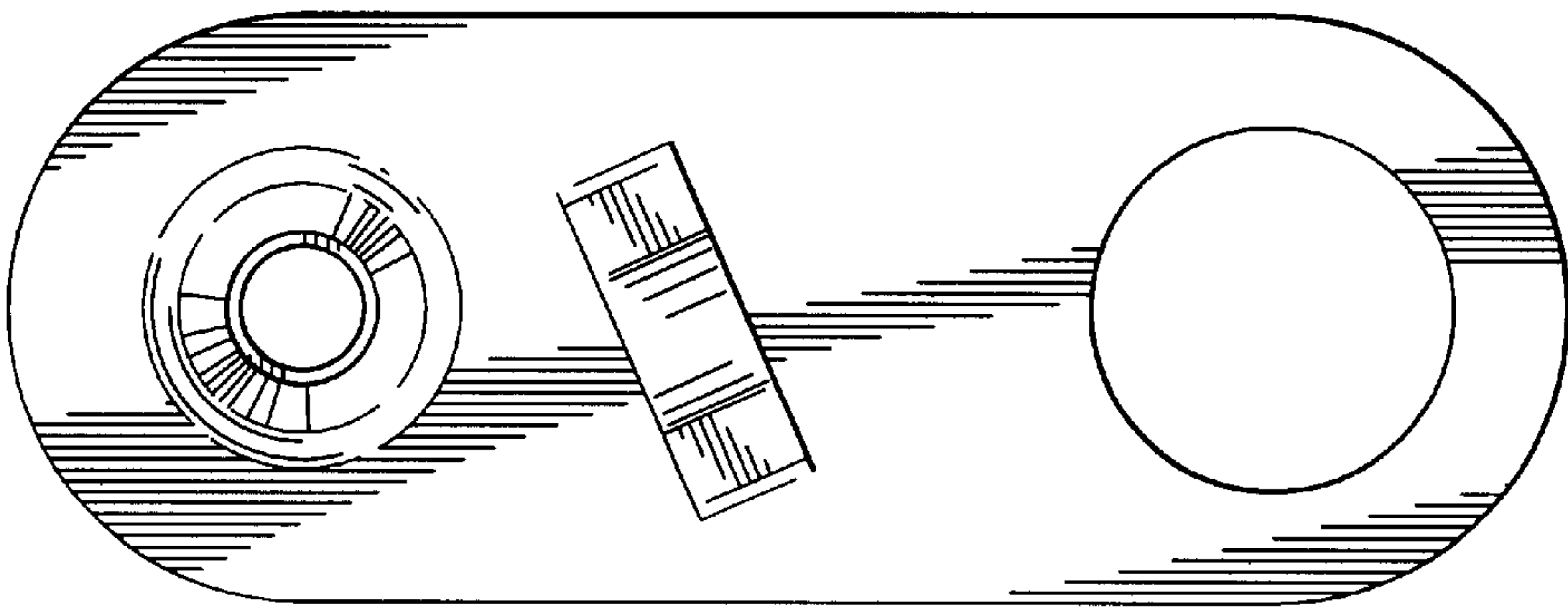

FIG. 2

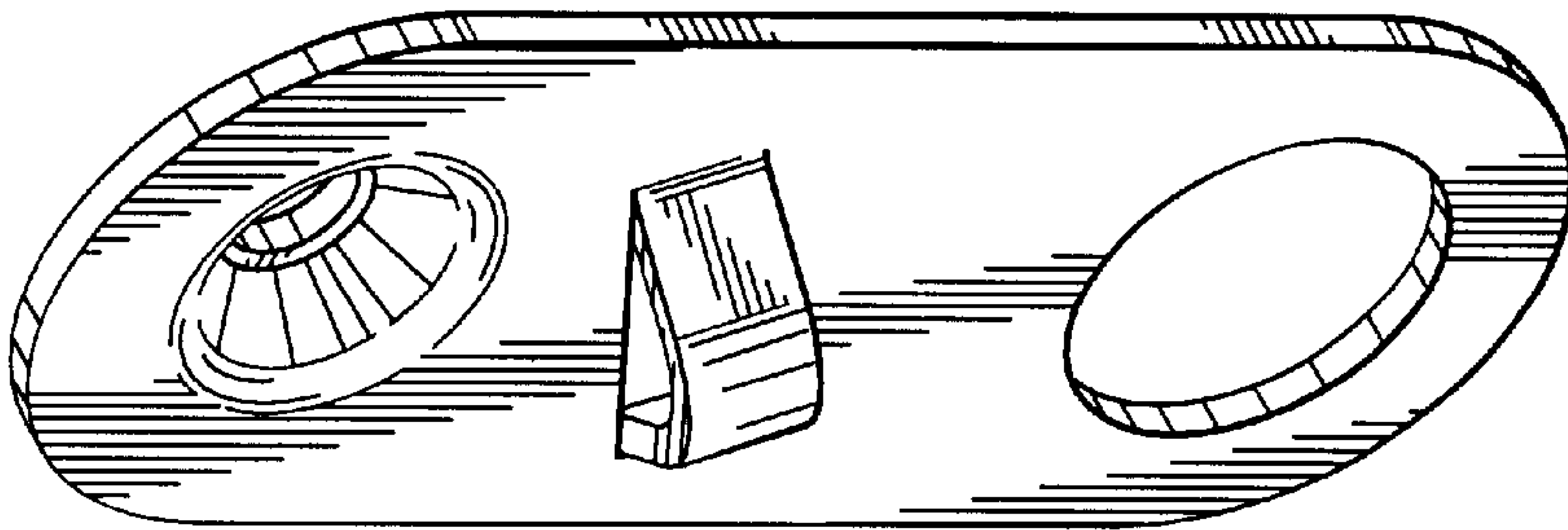

FIG. 1

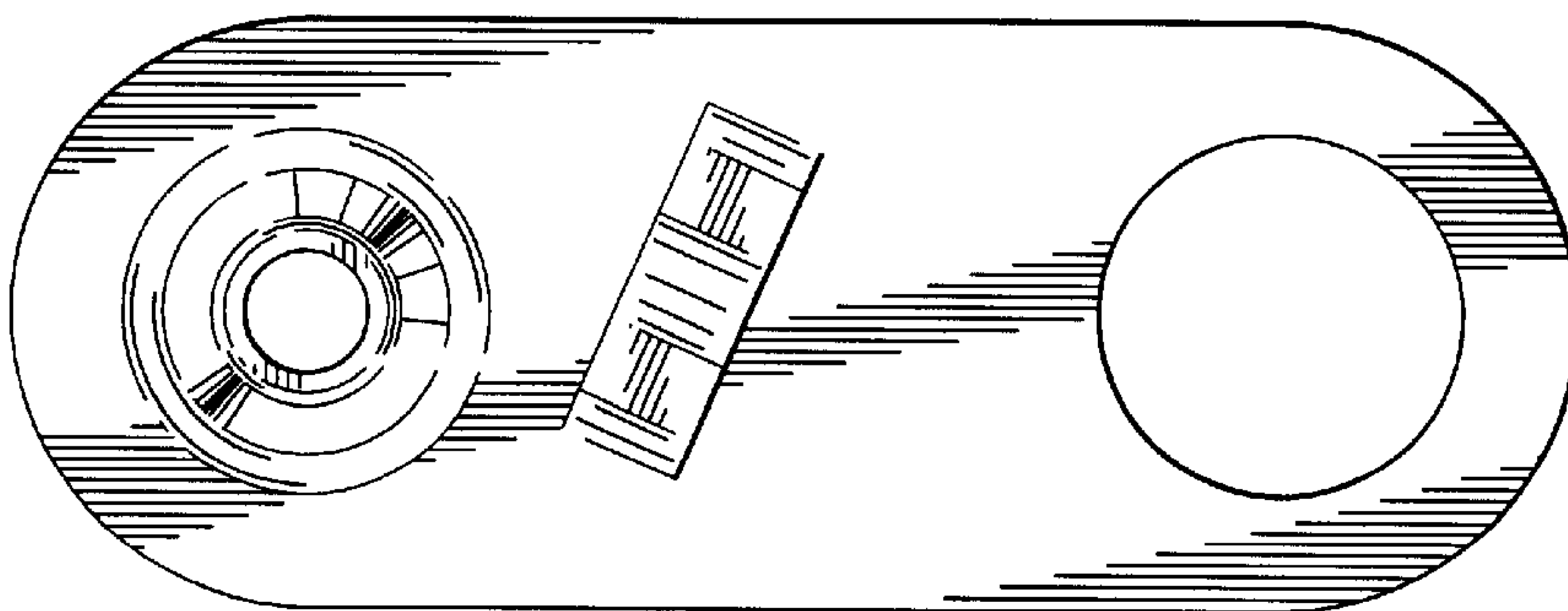

FIG. 4

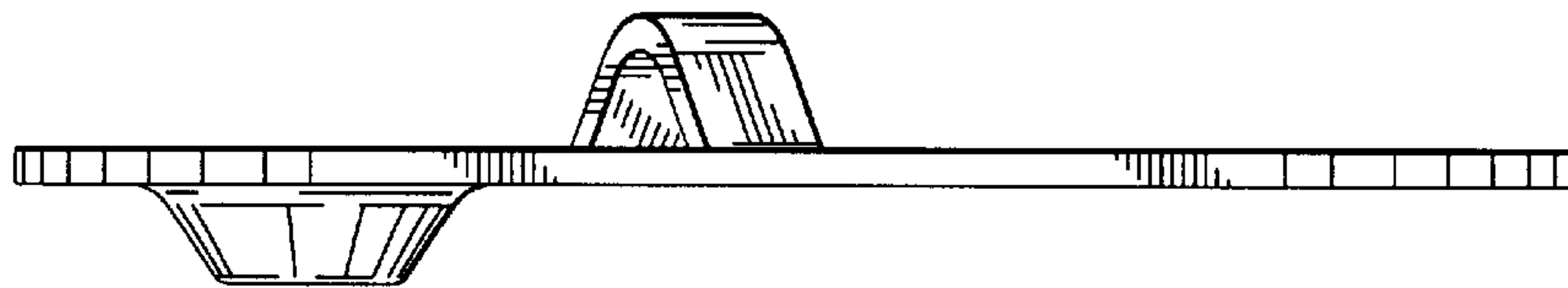

FIG. 5

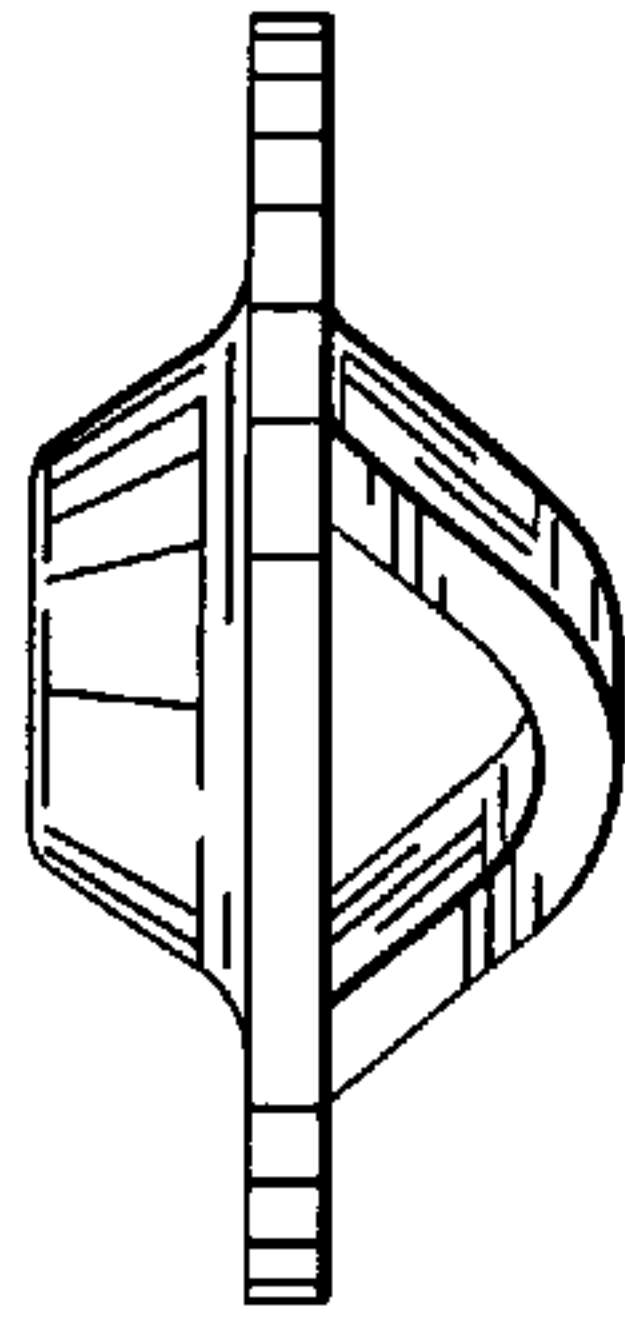

FIG. 6

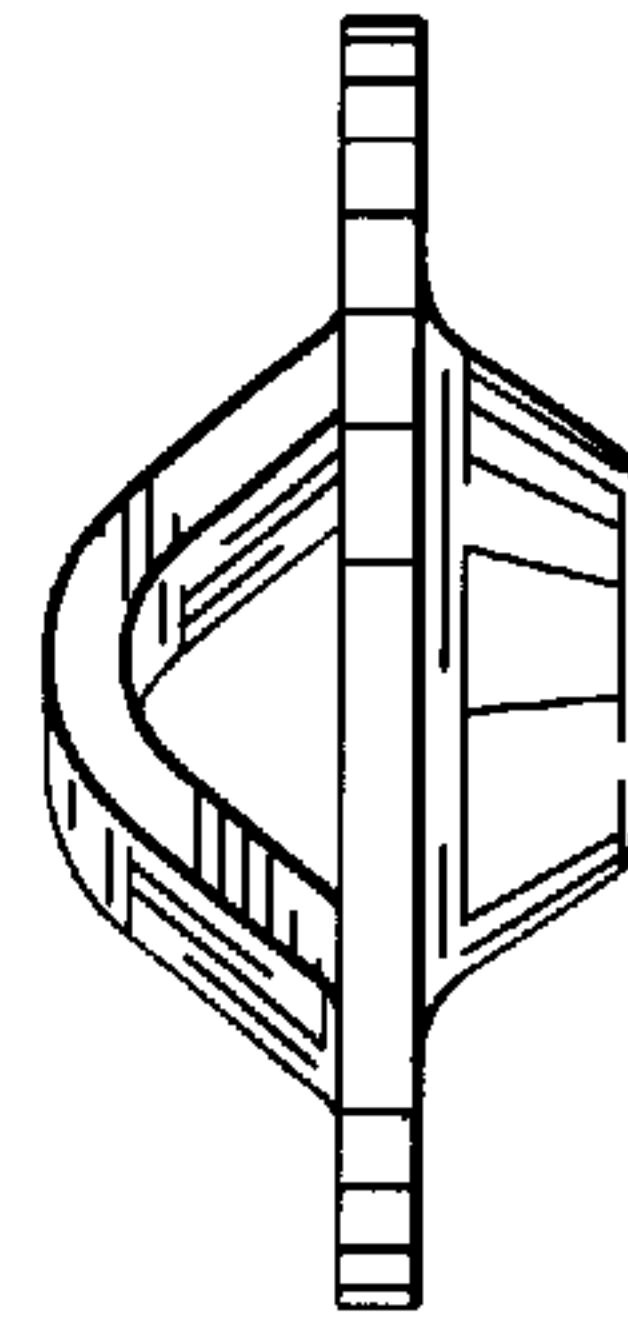

FIG. 7

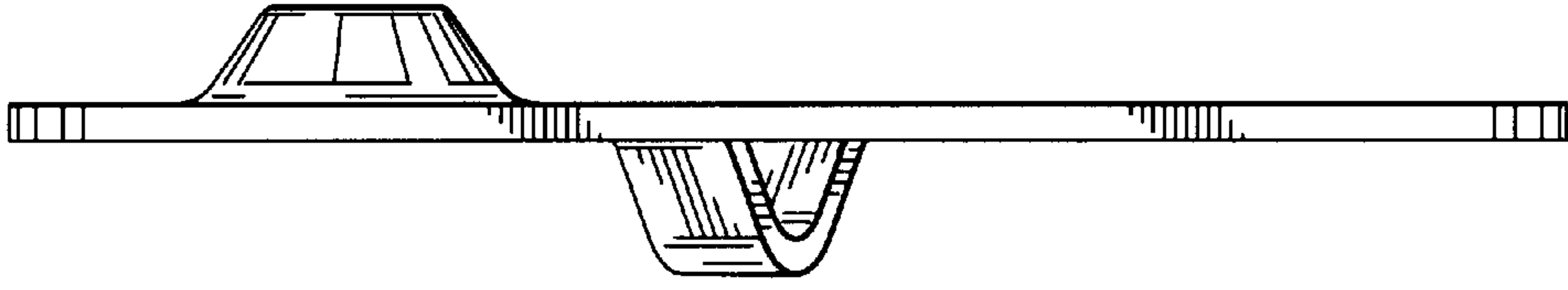

FIG. 10

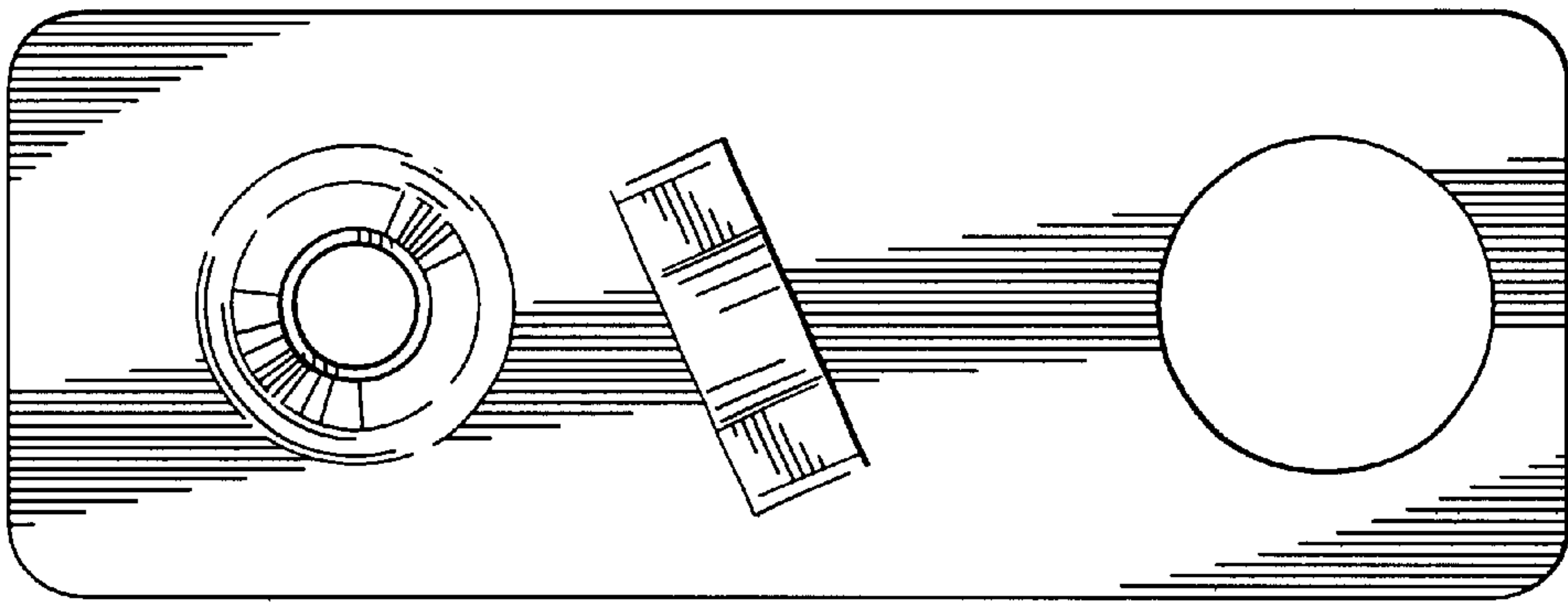

FIG. 9

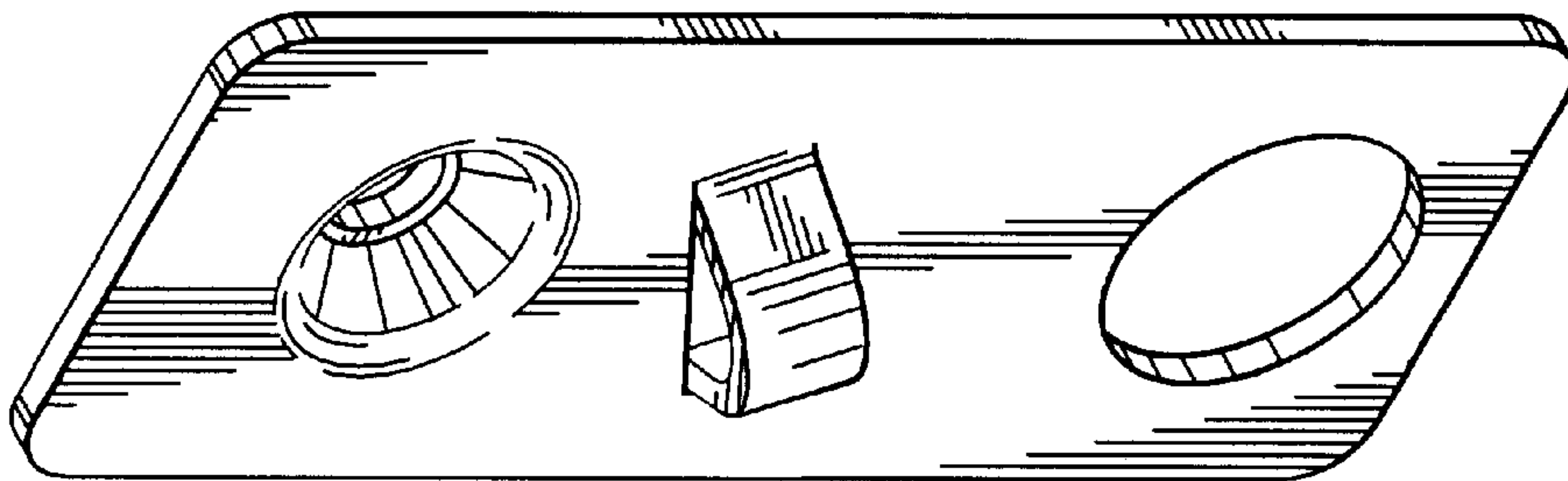

FIG. 8

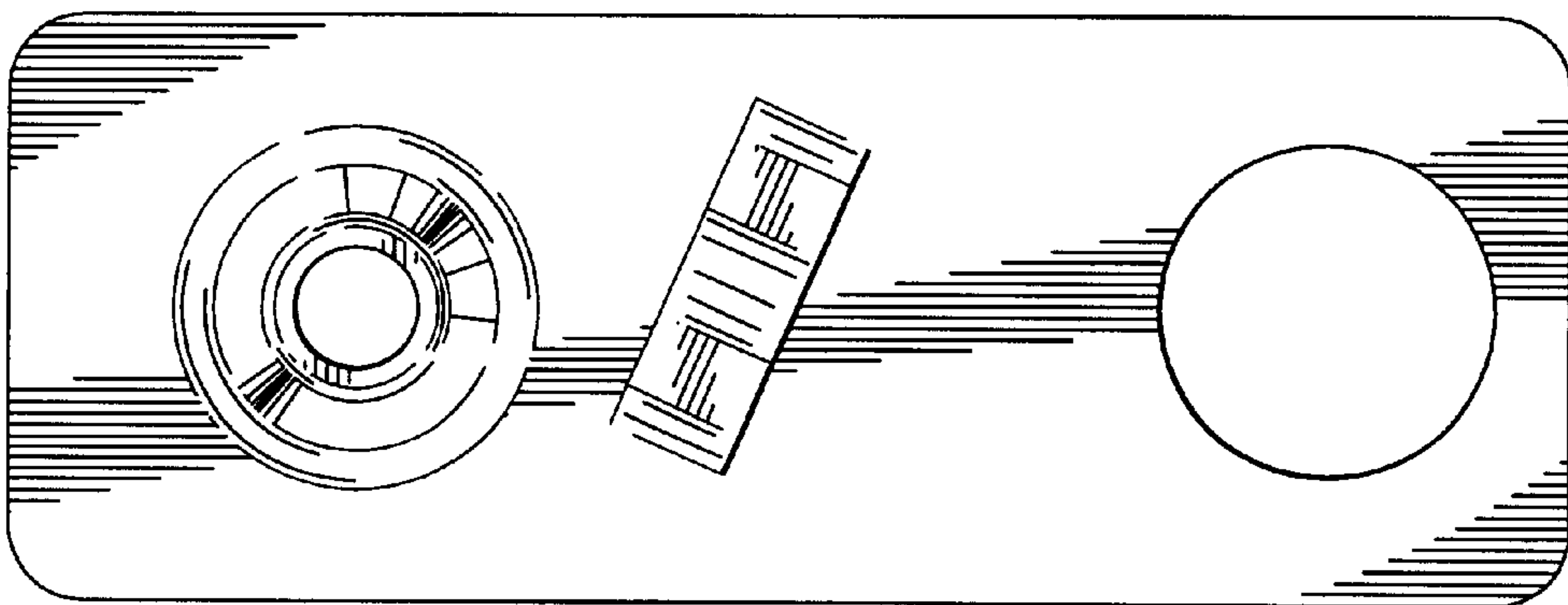

FIG. 11

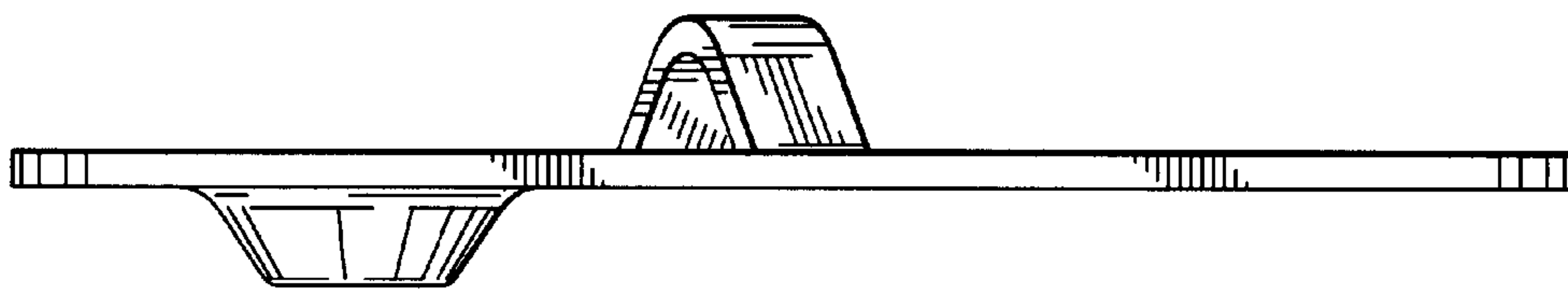

FIG. 12

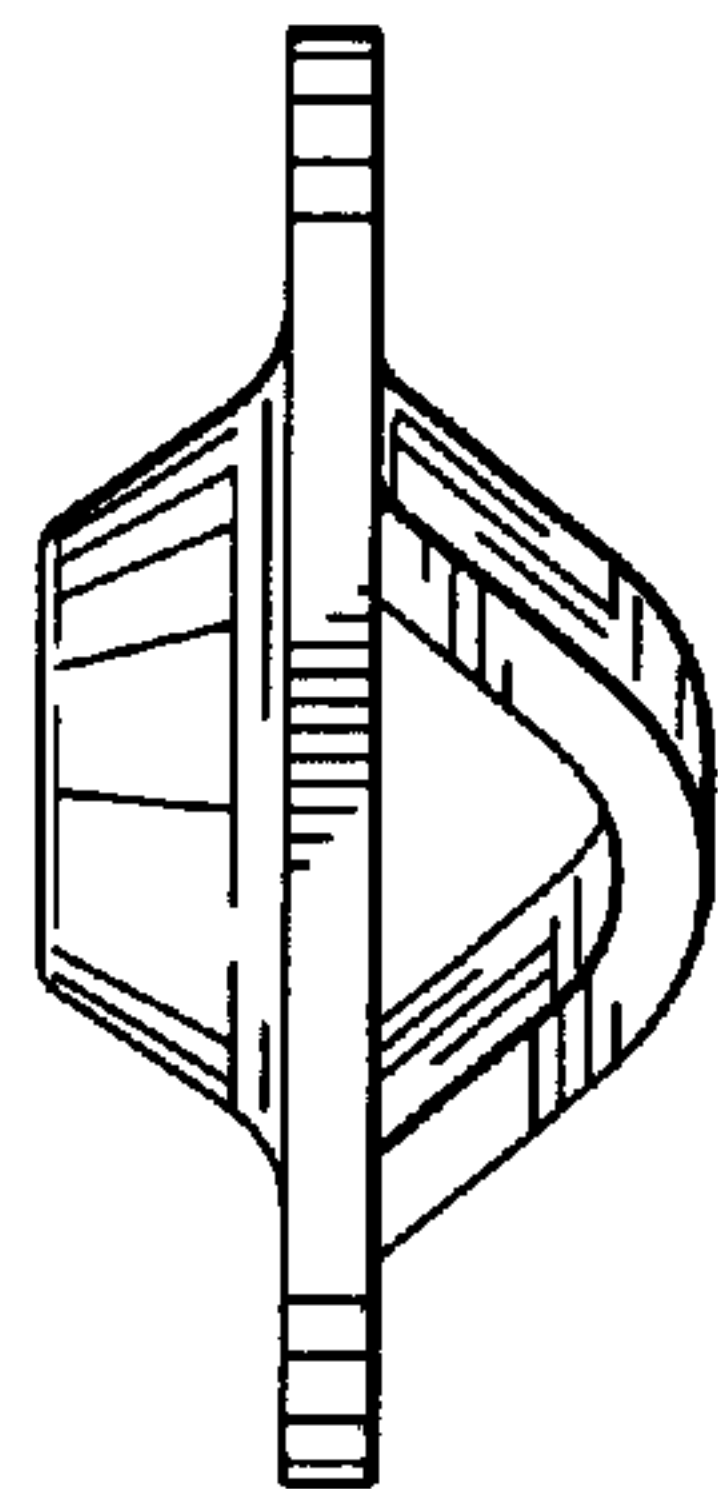

FIG. 13

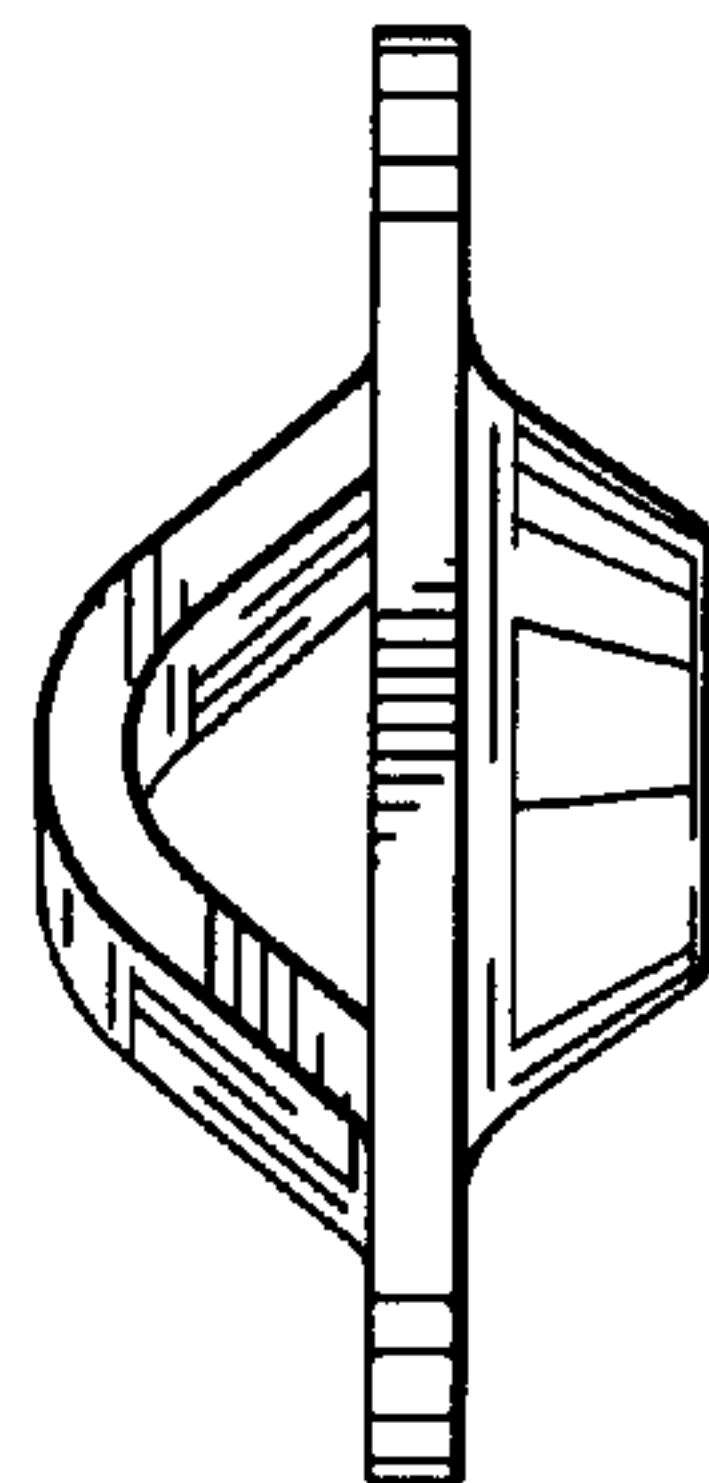

FIG. 14