



US00D481542S

(12) **United States Design Patent**
Leisch

(10) **Patent No.:** **US D481,542 S**

(45) **Date of Patent:** **** Nov. 4, 2003**

(54) **CARRYING CONTAINER**

(75) Inventor: **Franz Leisch, Linz (AT)**

(73) Assignee: **STECO Logistic GmbH, Pinsdorf (AT)**

(**) Term: **14 Years**

(21) Appl. No.: **29/162,107**

(22) Filed: **Jun. 10, 2002**

(30) **Foreign Application Priority Data**

Dec. 11, 2001 (AT) MU 4407/2001

(51) **LOC (7) Cl.** **03-01**

(52) **U.S. Cl.** **D3/309**

(58) **Field of Search** D3/304, 305, 307,
D3/312-314; 206/503-508, 509, 784, 203,
511-512; 220/1.5, 6, 4.28, 666, 669, 680,
682, 691, DIG. 12, DIG. 14, DIG. 15

(56) **References Cited**

U.S. PATENT DOCUMENTS

4,820,383	A	*	4/1989	Shchamorov et al.	220/6
4,913,302	A	*	4/1990	Stonier	220/6
D381,513	S	*	7/1997	Brauner	D3/305
6,073,790	A	*	6/2000	Umiker	220/6
6,189,695	B1	*	2/2001	Ching-rong	206/509
D452,614	S	*	1/2002	Overholt	D3/305
6,446,825	B1	*	9/2002	Godoy	220/1.5

* cited by examiner

Primary Examiner—Louis S. Zarfaz

Assistant Examiner—Deanne Levy

(74) *Attorney, Agent, or Firm*—Collard & Roe, P.C.

(57) **CLAIM**

The ornamental design for a carrying container, as shown and described.

DESCRIPTION

FIG. 1 shows a top perspective view of my design for a carrying container according to the invention;

FIG. 2 shows a bottom perspective view thereof;

FIG. 3 shows a front view thereof;

FIG. 4 shows a rear view thereof;

FIG. 5 shows a side view thereof, with the opposite side view being a mirror image;

FIG. 6 shows a bottom view thereof;

FIG. 7 shows a top perspective view of my design for a carrying container in a folded position according to the invention;

FIG. 8 shows a bottom perspective view of my design in a folded position;

FIG. 9 shows a top view of my design in a folded position; and,

FIG. 10 shows a bottom view of my design in a folded position.

1 Claim, 10 Drawing Sheets

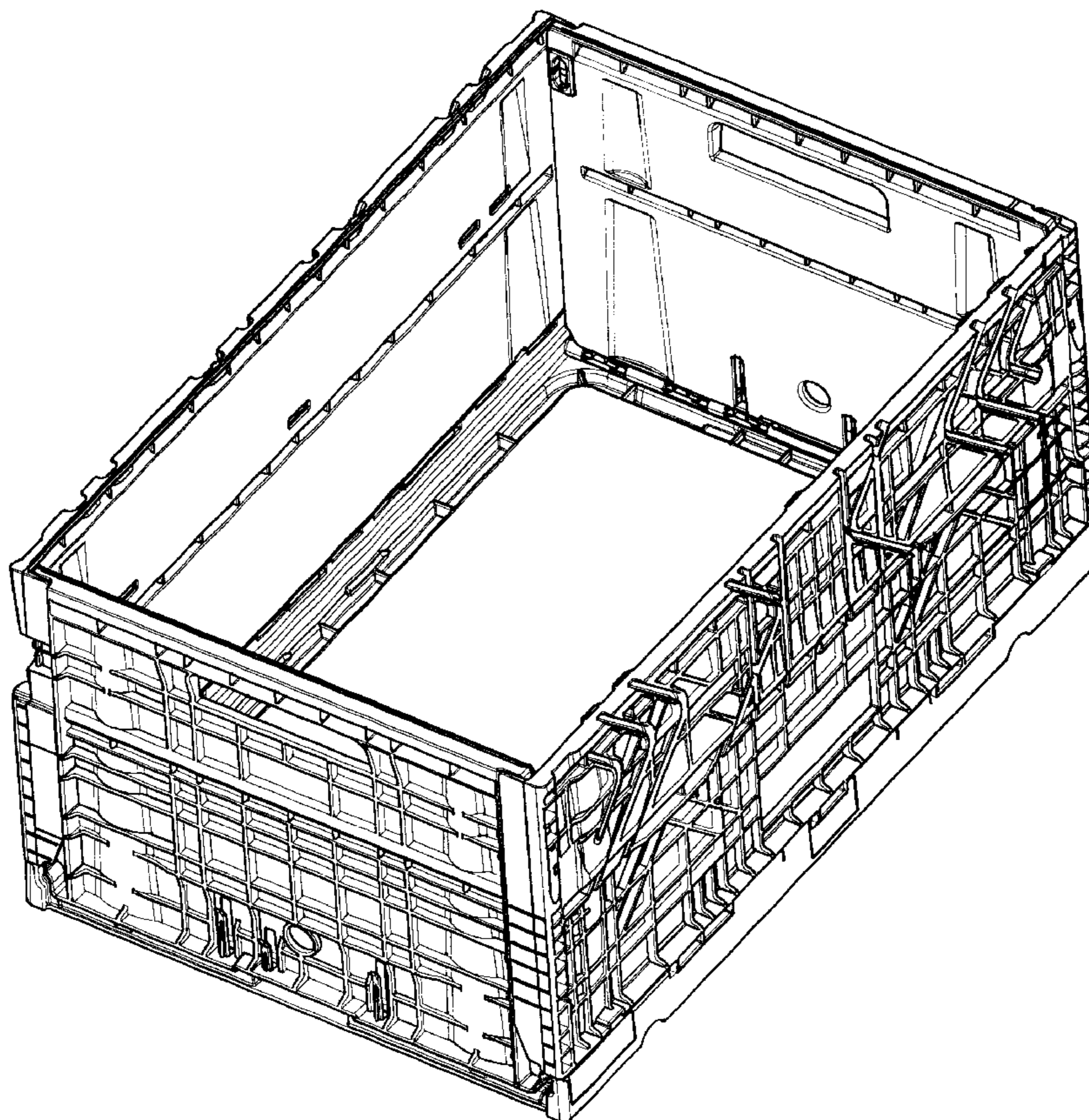

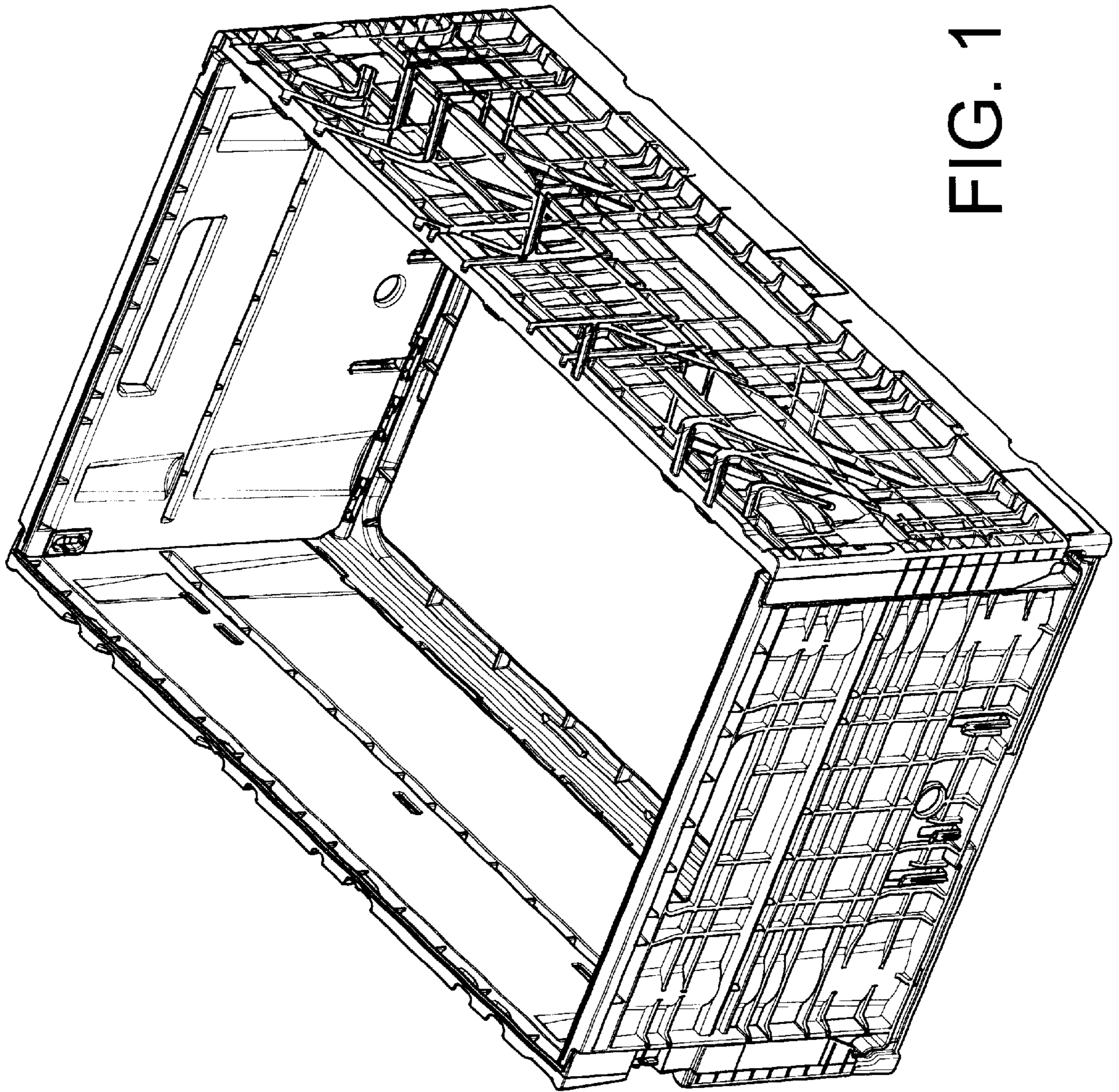

FIG. 1

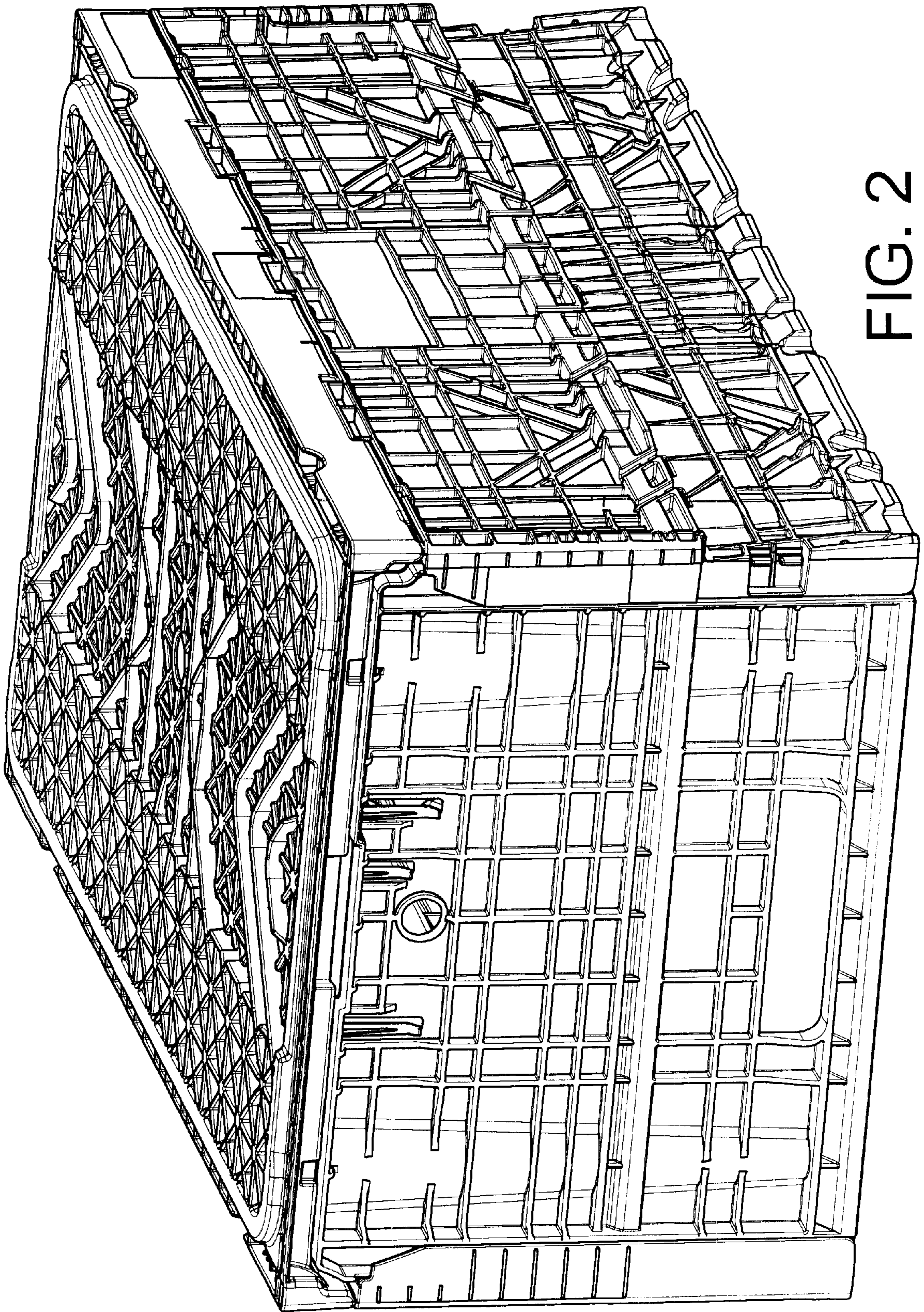

FIG. 2

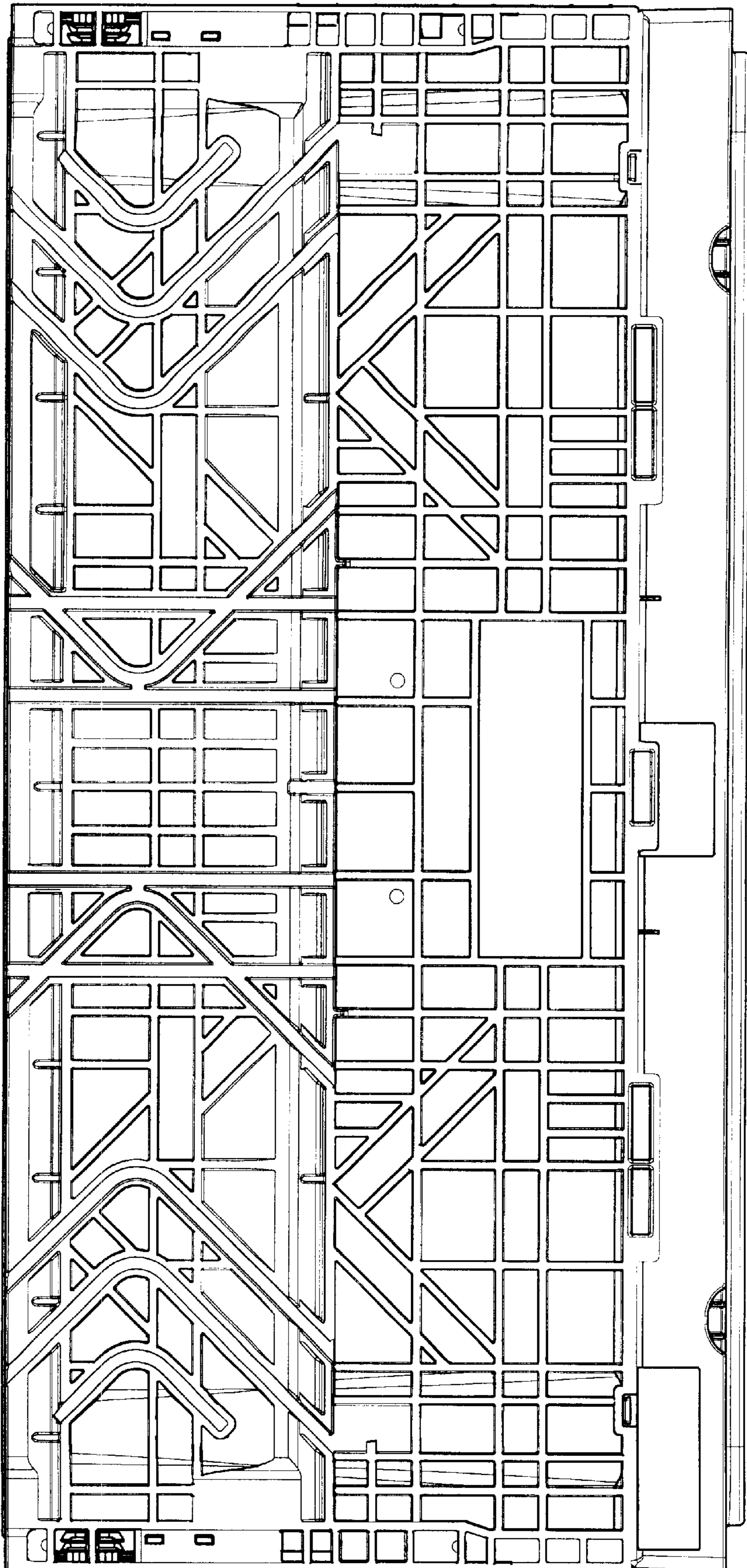

FIG. 3

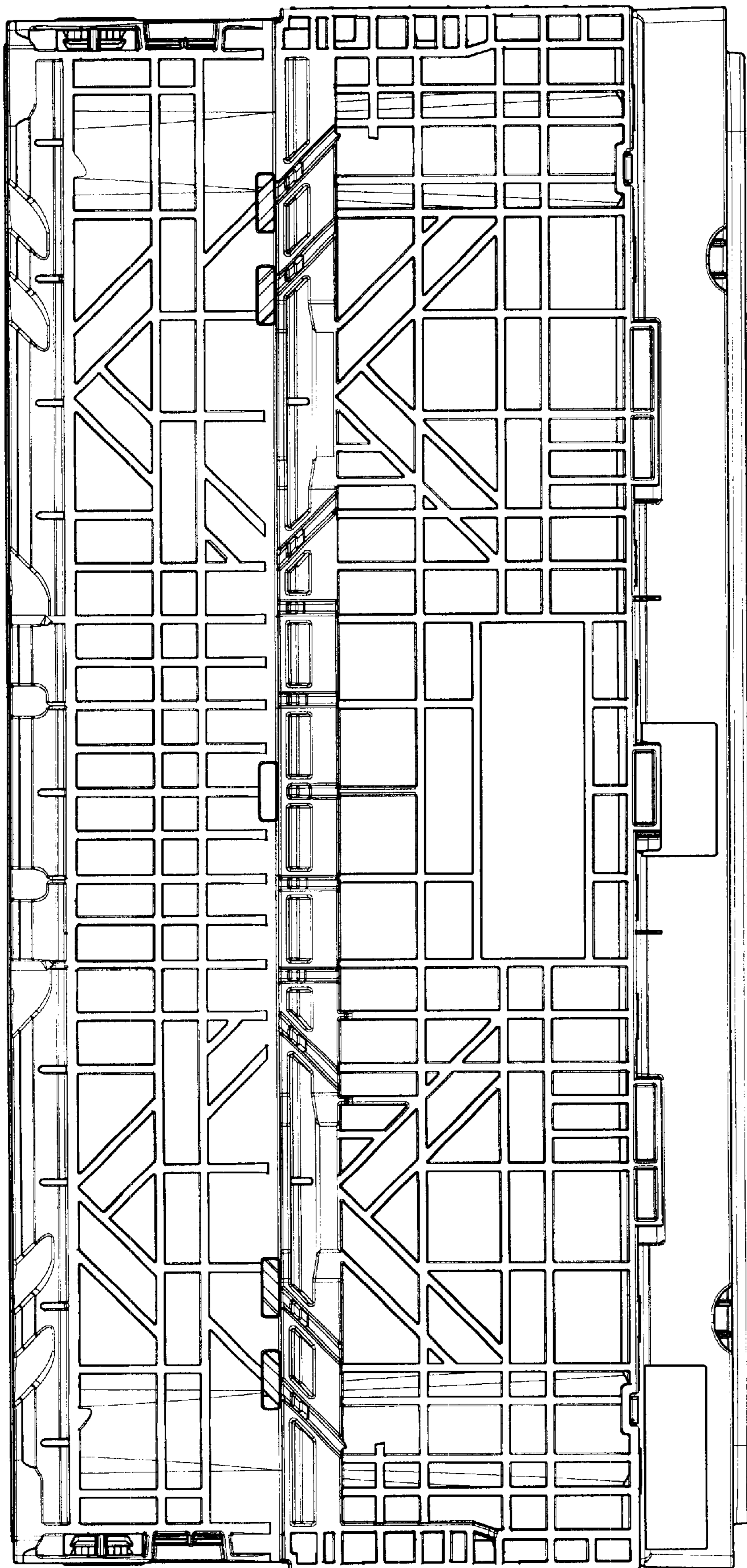

FIG. 4

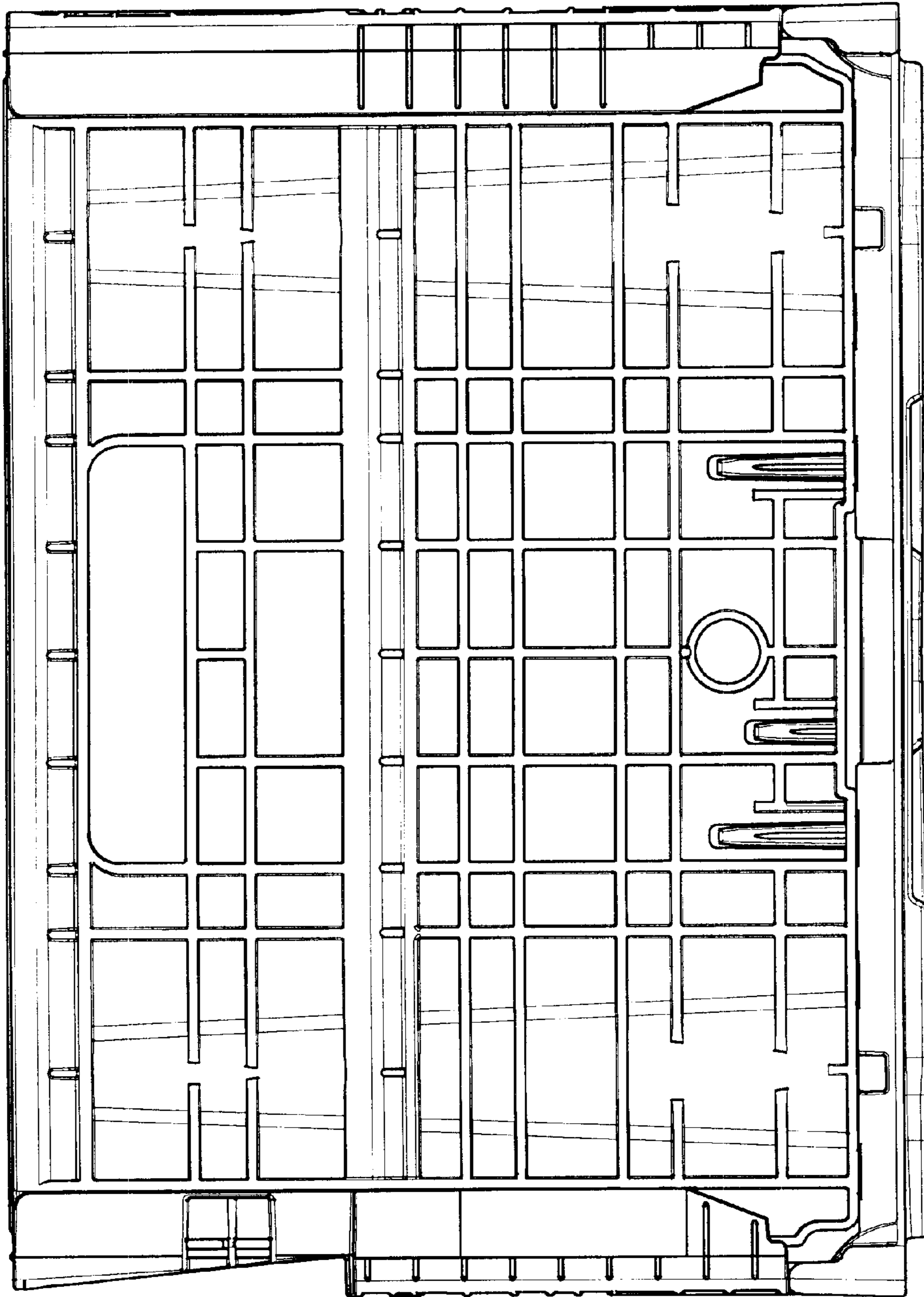

FIG. 5

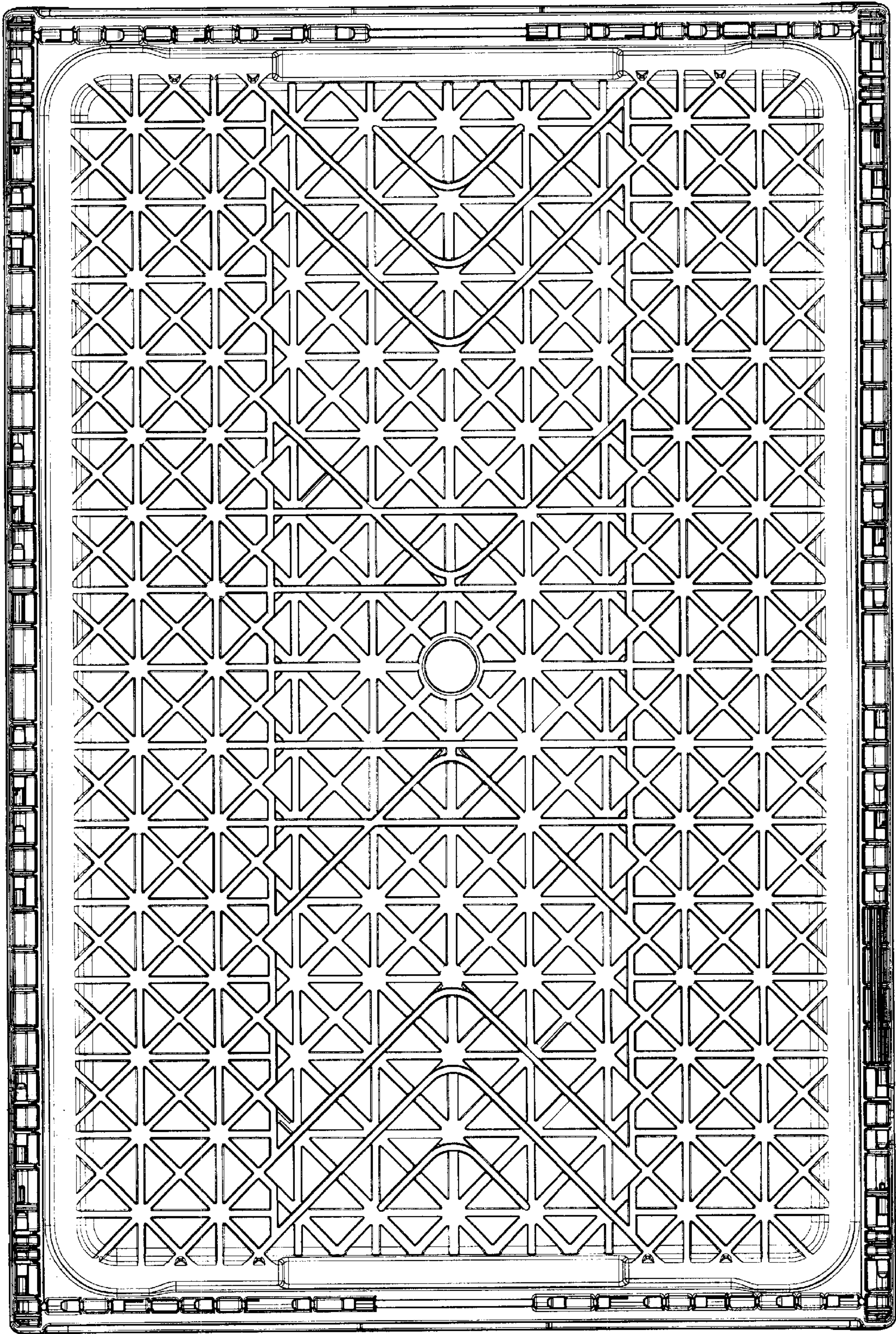

FIG. 6

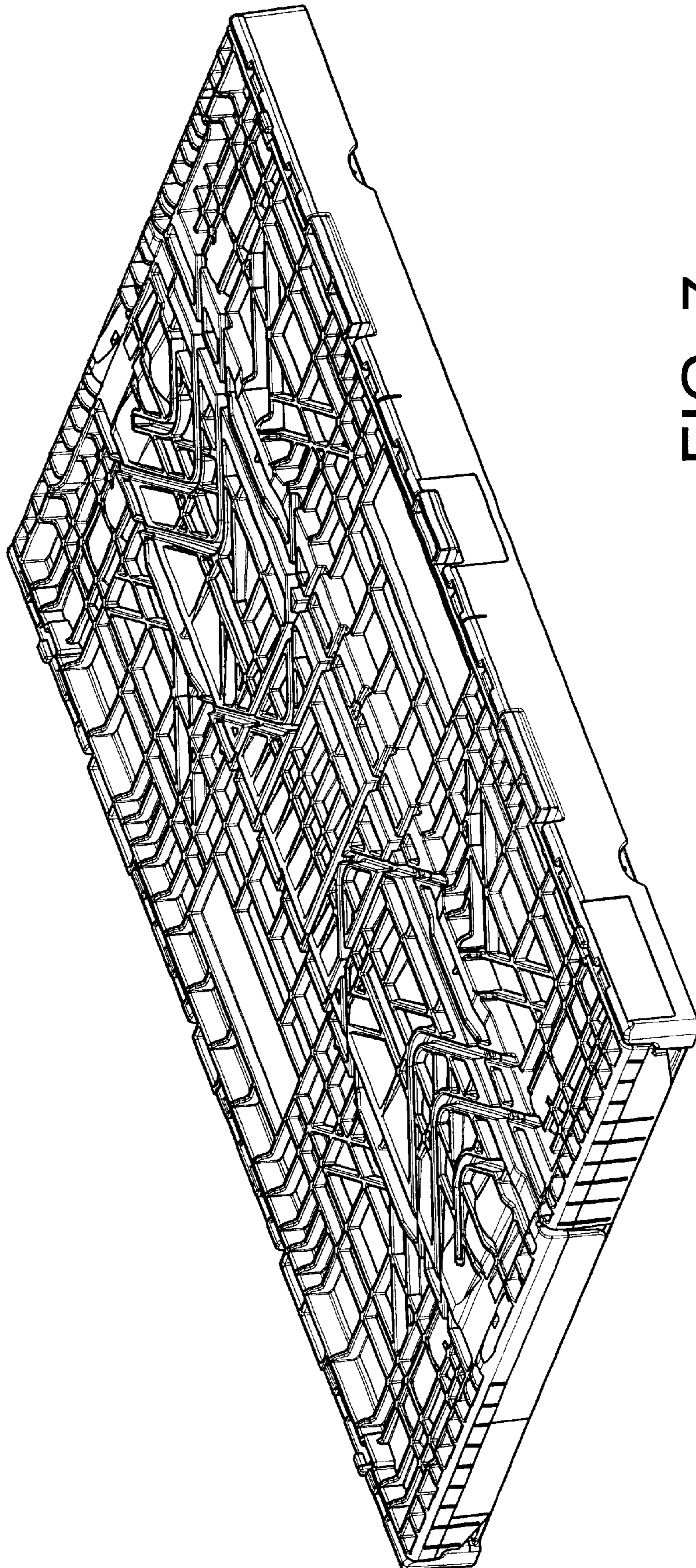

FIG. 7

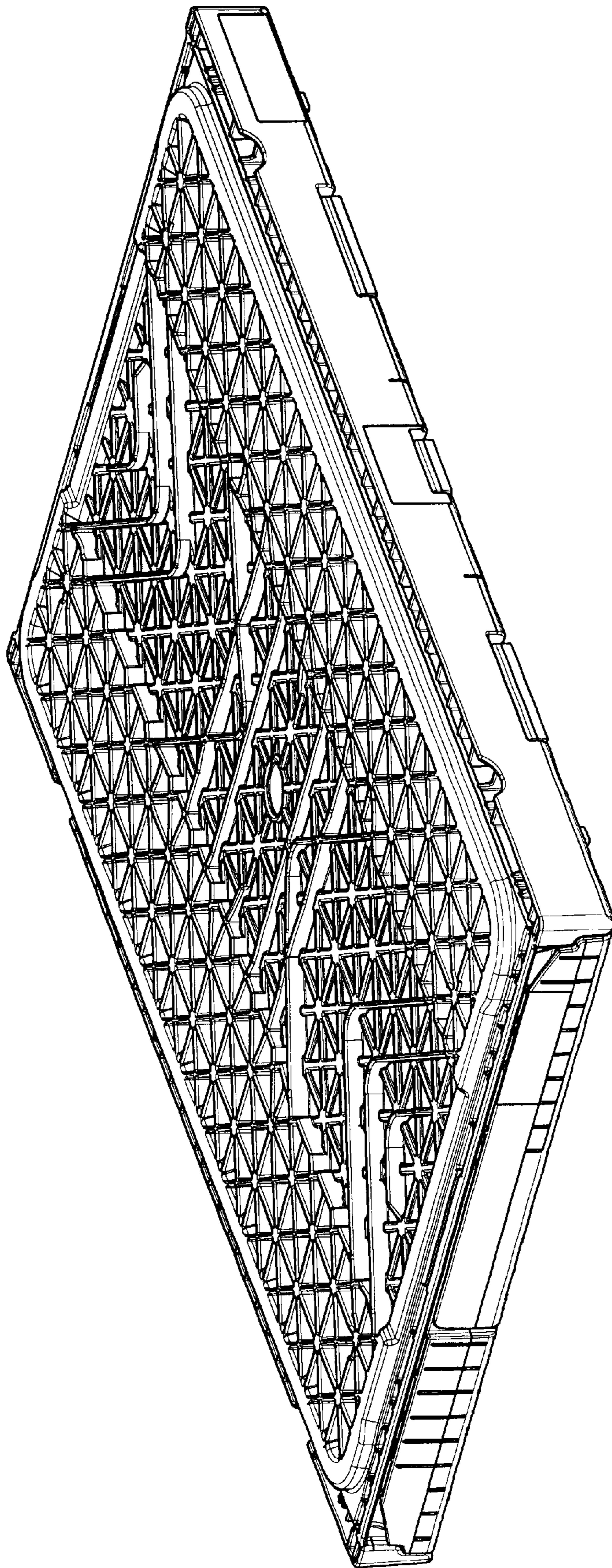

FIG. 8

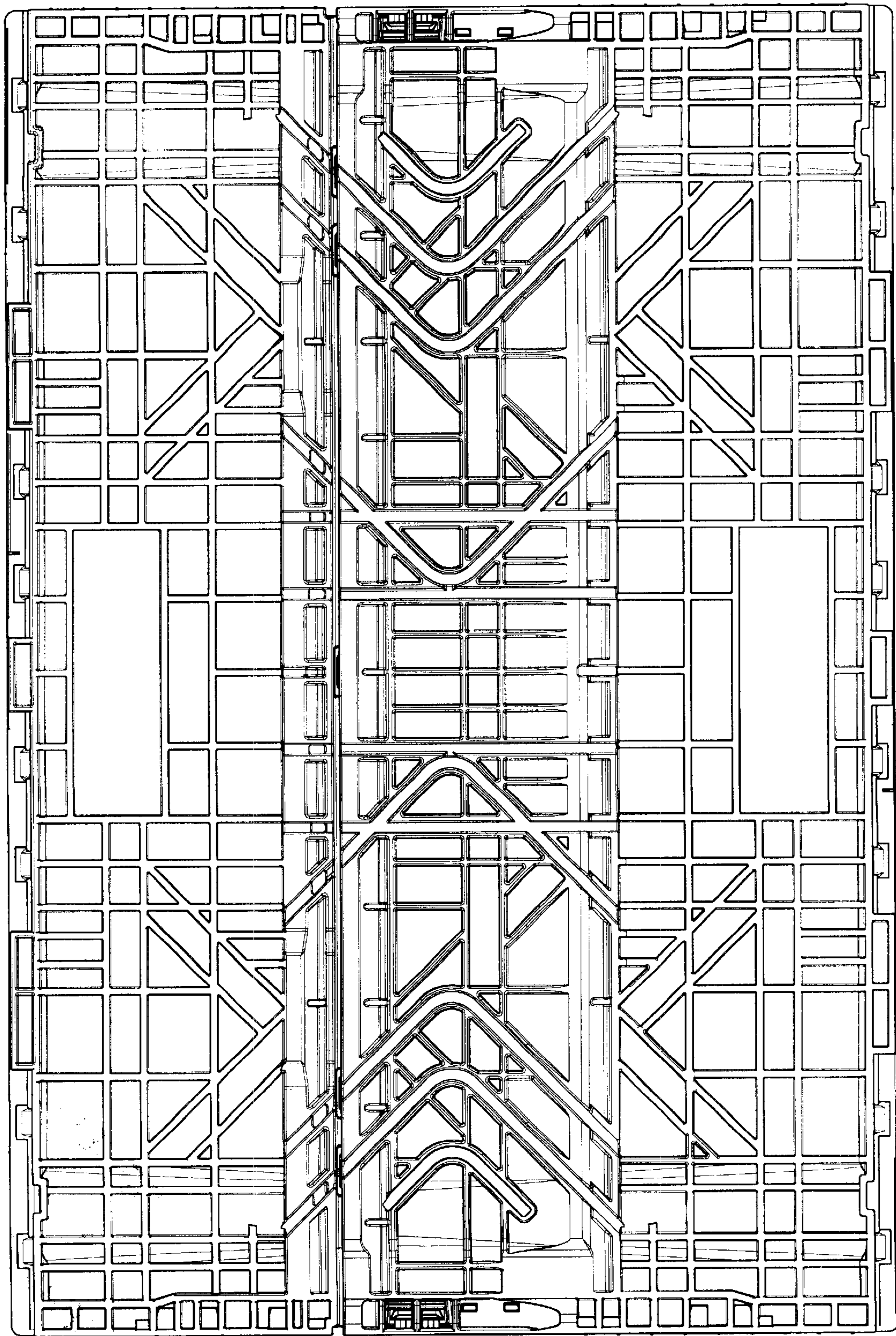

FIG. 9

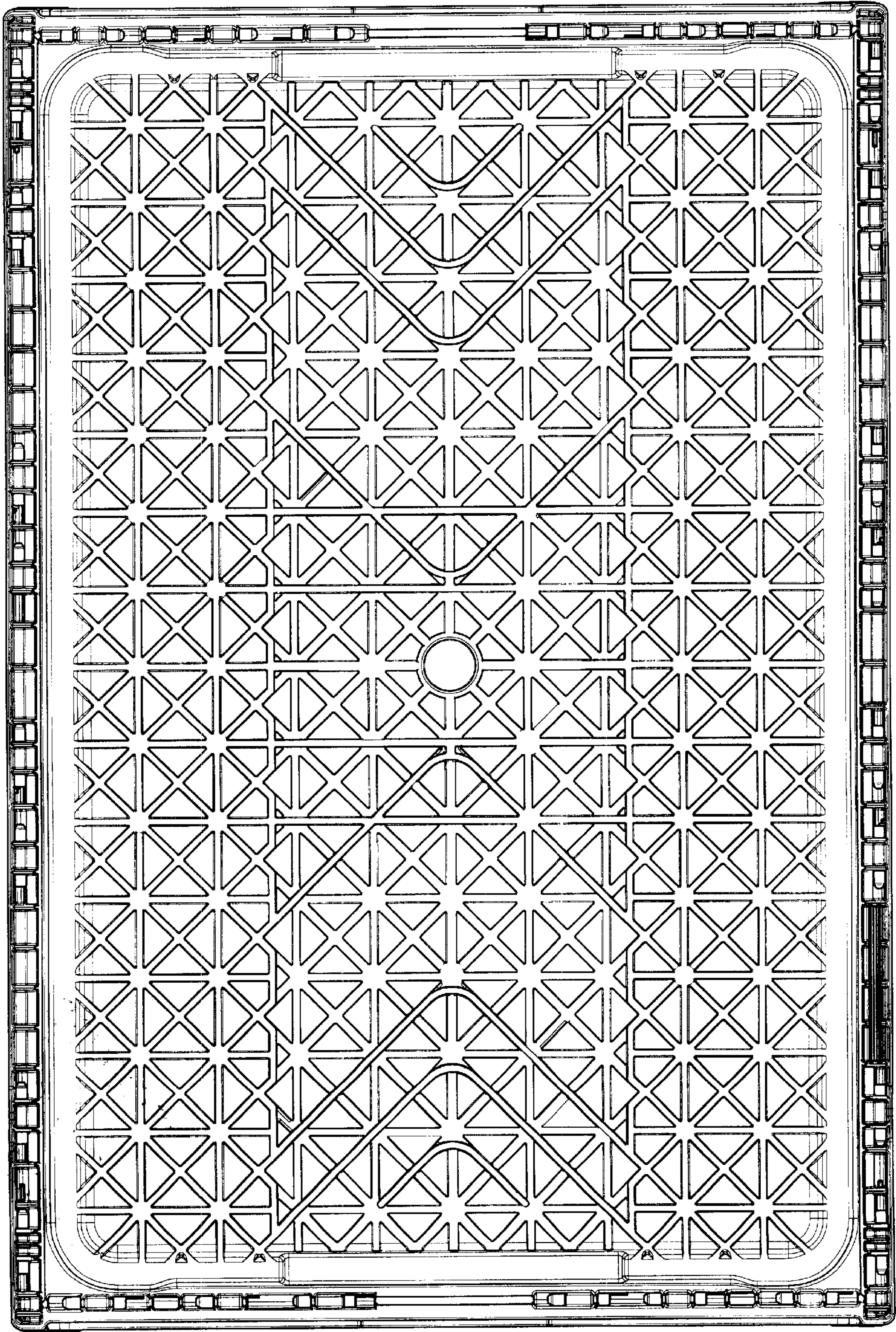

FIG. 10