



US00D481301S

(12) **United States Design Patent**
Nezu

(10) **Patent No.:** **US D481,301 S**

(45) **Date of Patent:** **** Oct. 28, 2003**

(54) **CORD FASTENER**

(75) Inventor: **Mikio Nezu**, Suita (JP)
(73) Assignee: **NIFCO Inc.**, Yokohama (JP)
(**) Term: **14 Years**

(21) Appl. No.: **29/172,433**
(22) Filed: **Dec. 12, 2002**

(30) **Foreign Application Priority Data**

Jun. 20, 2002 (JP) 2002-016522

(51) **LOC (7) Cl.** **08-03**
(52) **U.S. Cl.** **D8/383**
(58) **Field of Search** D8/383; 24/115 R,
24/115 H, 115 M, 115 G, 115 K, 129 R

(56) **References Cited**

U.S. PATENT DOCUMENTS

3,409,950 A * 11/1968 Boyd 24/115 R
D343,570 S * 1/1994 Meier D8/383
5,621,952 A * 4/1997 Frano 24/115 G
5,671,505 A * 9/1997 Anscher 24/115 G
D402,190 S * 12/1998 Anscher D8/383

FOREIGN PATENT DOCUMENTS

EP 291154 A2 * 11/1988 B65D/33/28
* cited by examiner

Primary Examiner—Holly Baynham
(74) *Attorney, Agent, or Firm*—Kanesaka & Takeuchi

(57) **CLAIM**

The ornamental design for a cord fastener, as shown and described.

DESCRIPTION

FIG. 1 is a perspective view of a cord fastener showing my new design;
FIG. 2 is a front view thereof;
FIG. 3 is a right view thereof;
FIG. 4 is a left view thereof;
FIG. 5 is a plan view thereof;
FIG. 6 is a bottom view thereof;
FIG. 7 is a sectional view thereof taken along line 7—7 of FIG. 2; and,
FIG. 8 is a sectional view thereof taken along line 8—8 of FIG. 2.

1 Claim, 4 Drawing Sheets

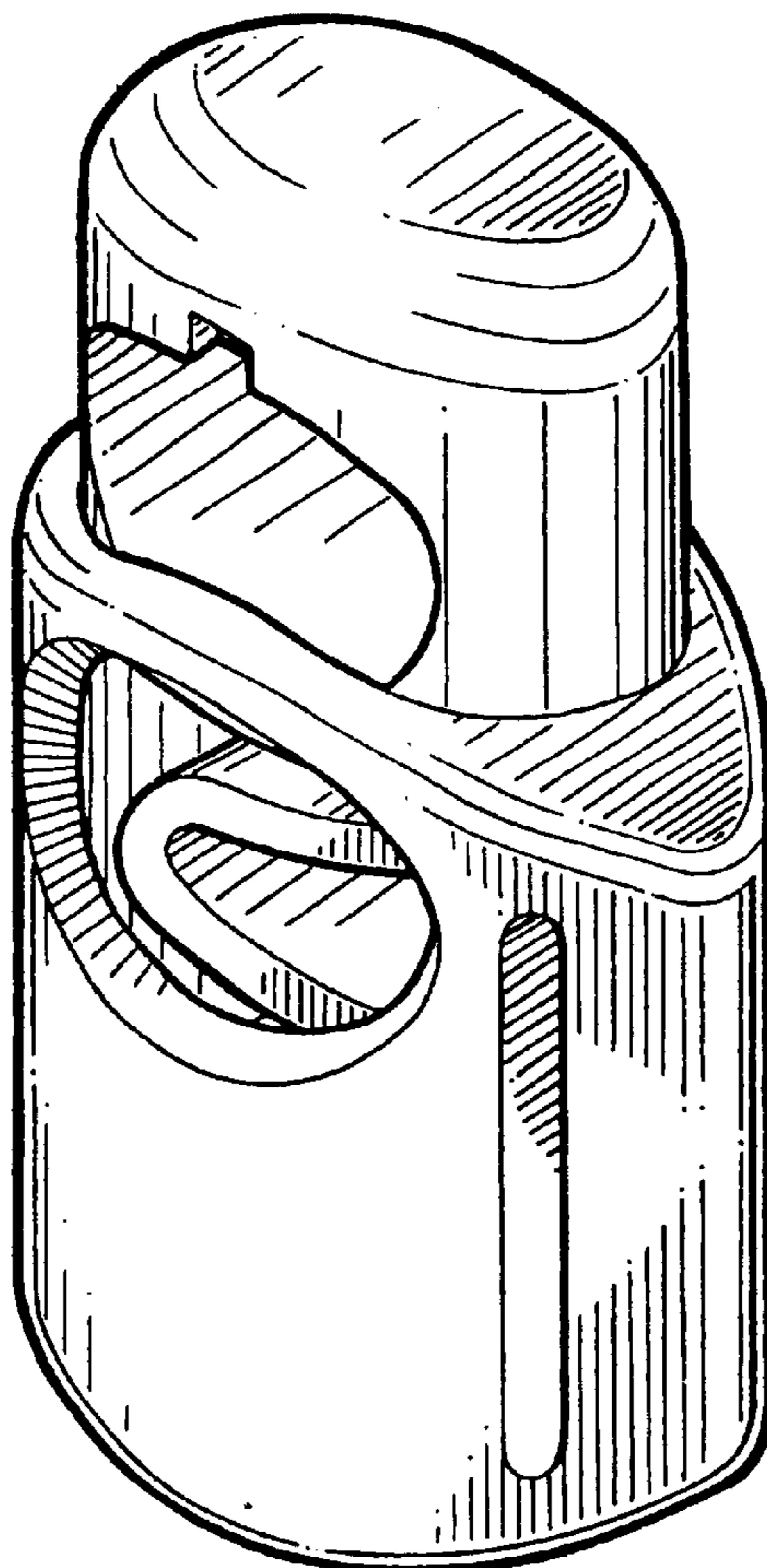

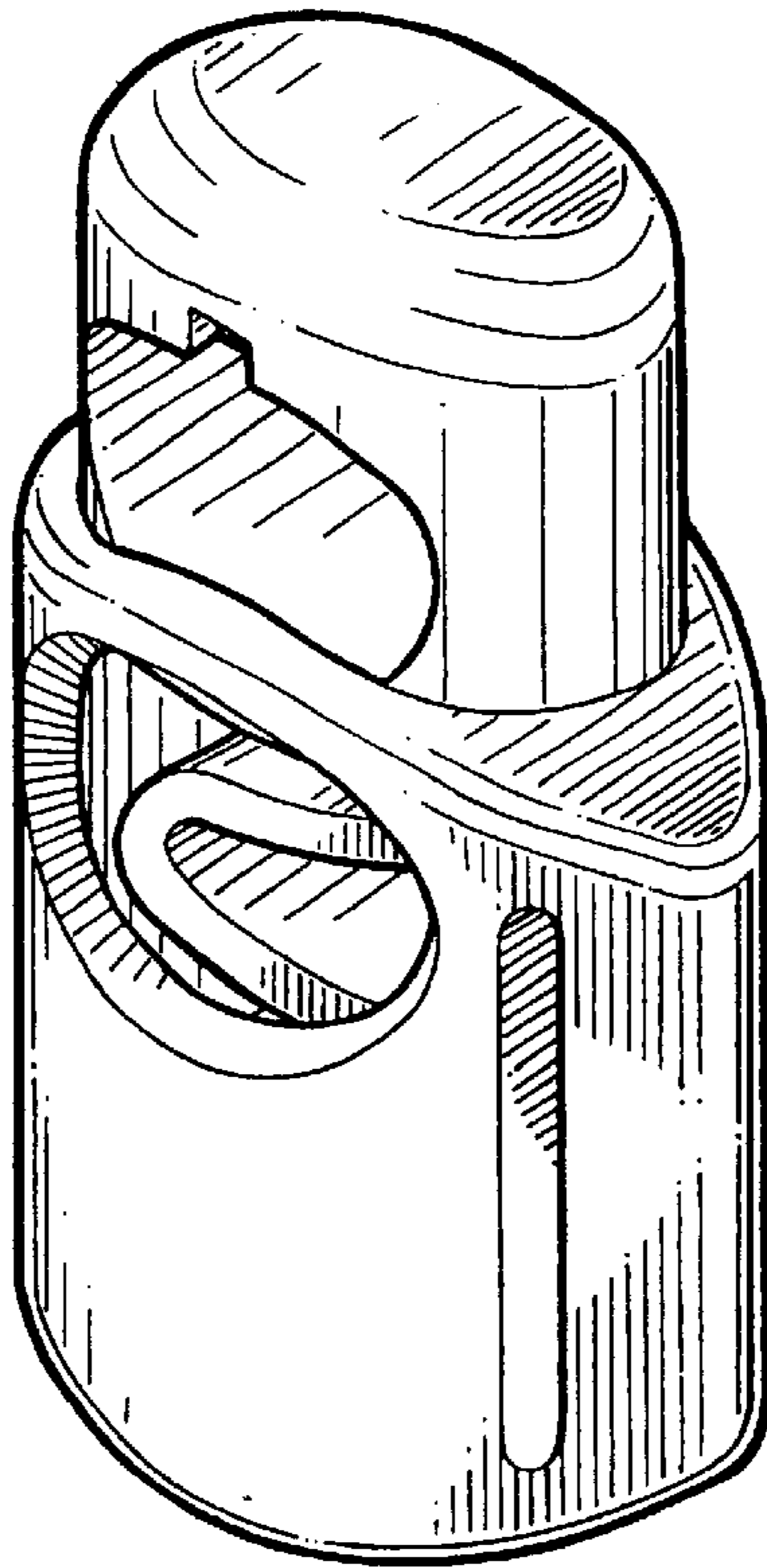

FIG. 1

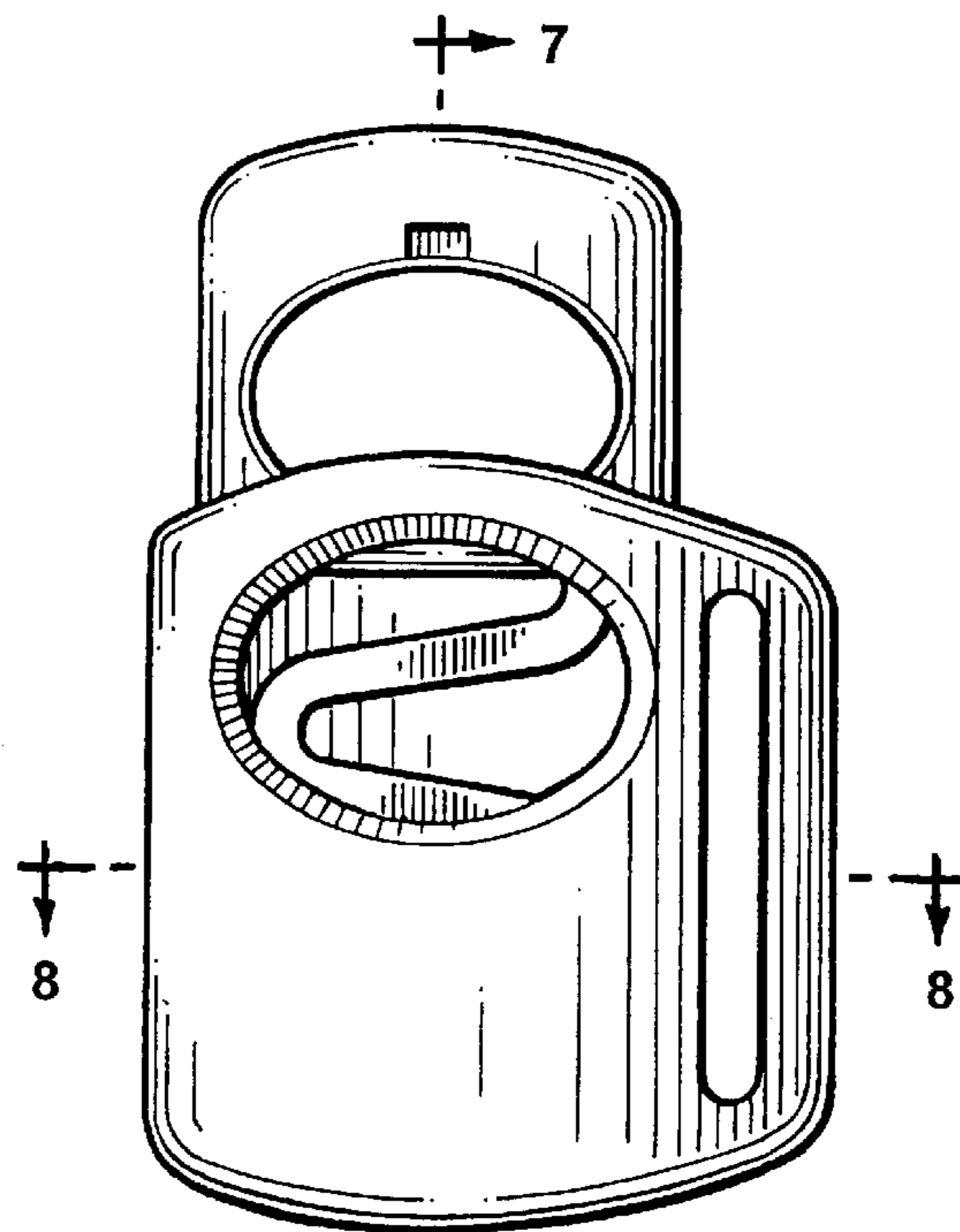

FIG. 2

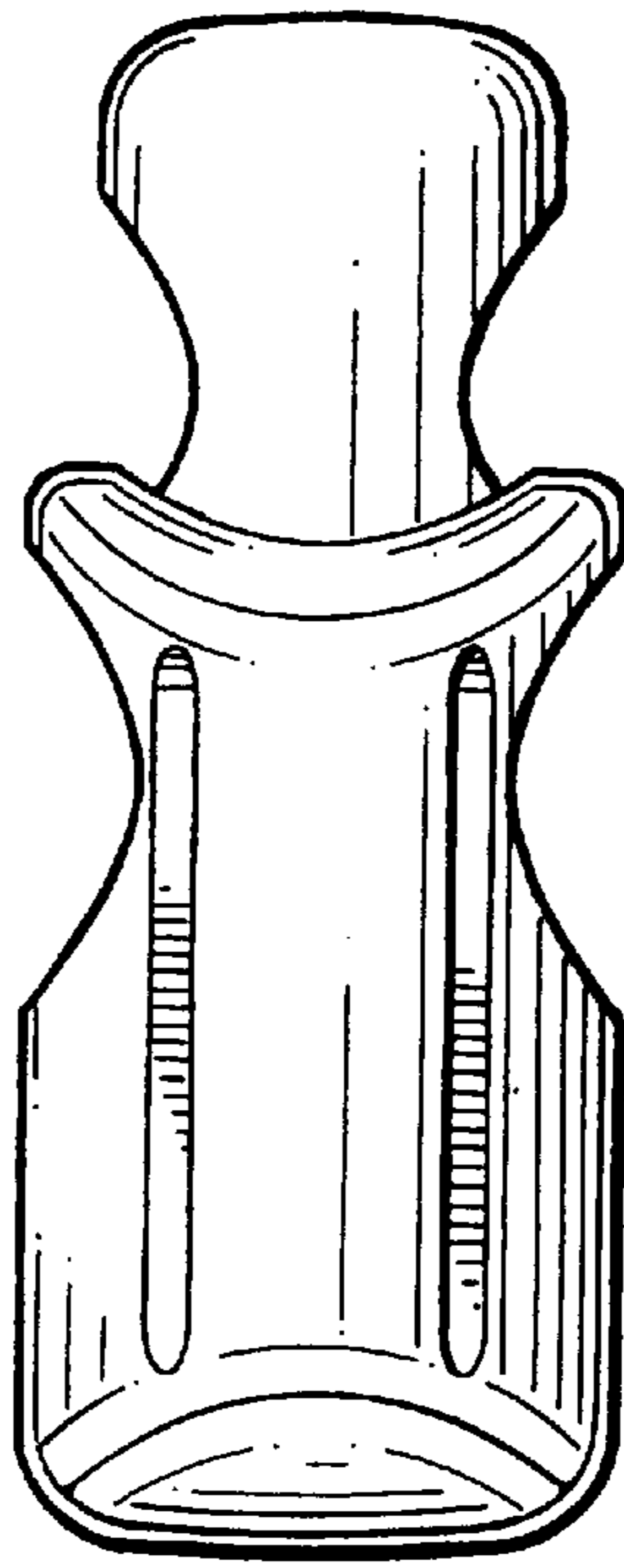

FIG. 3

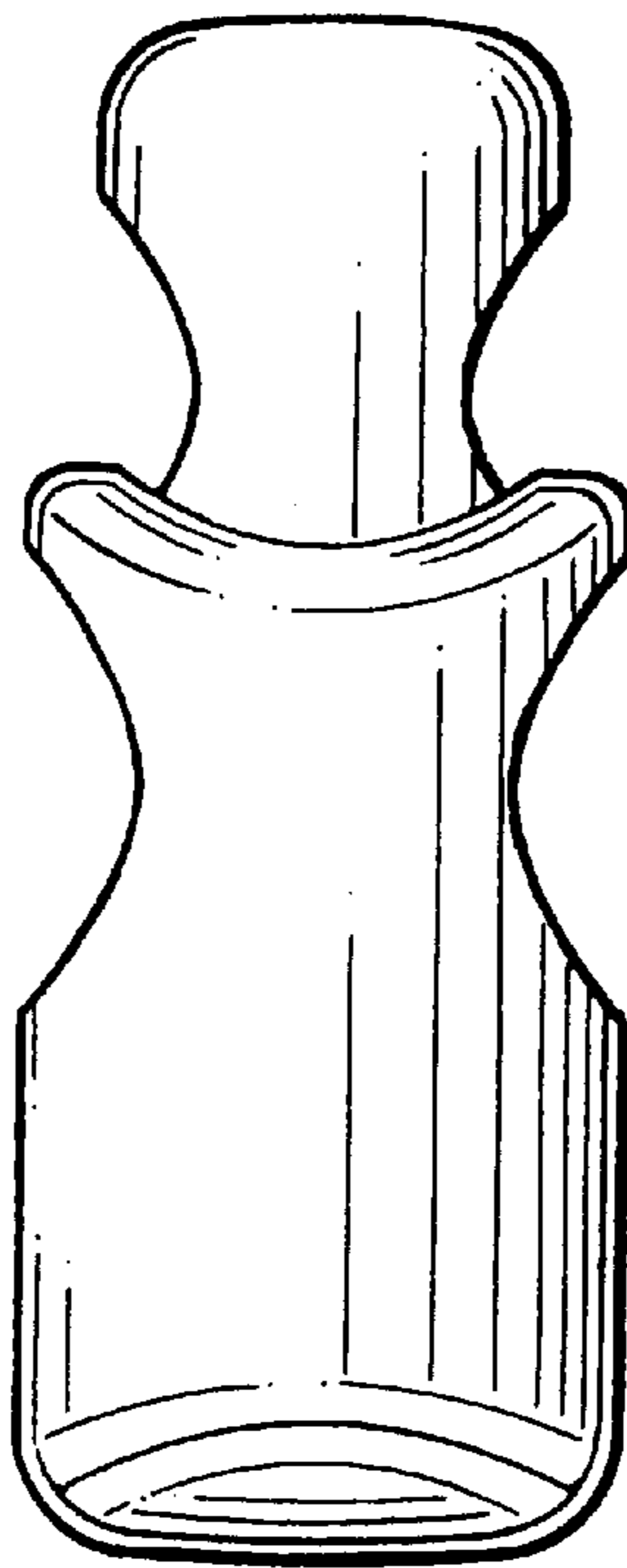

FIG. 4

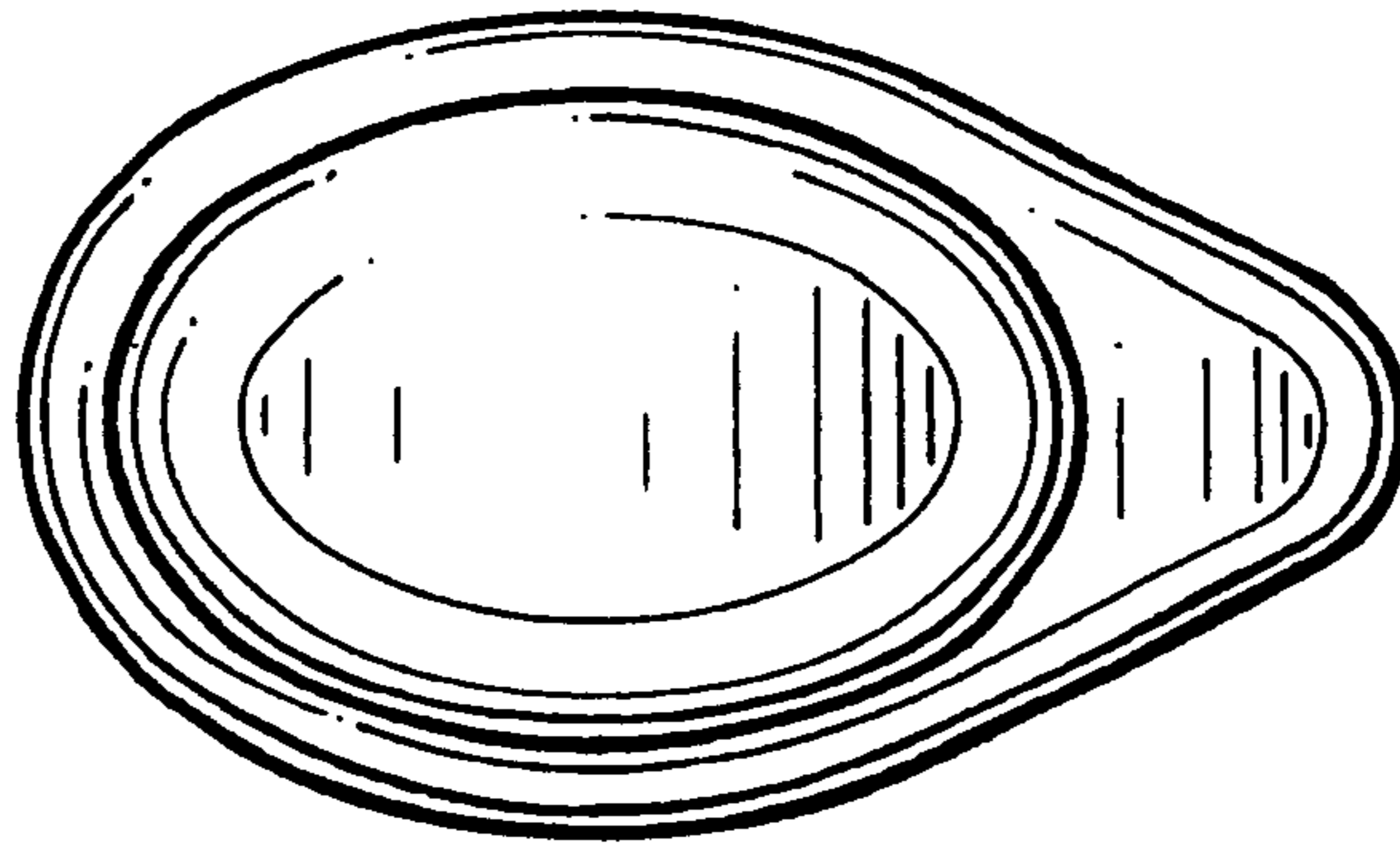

FIG. 5

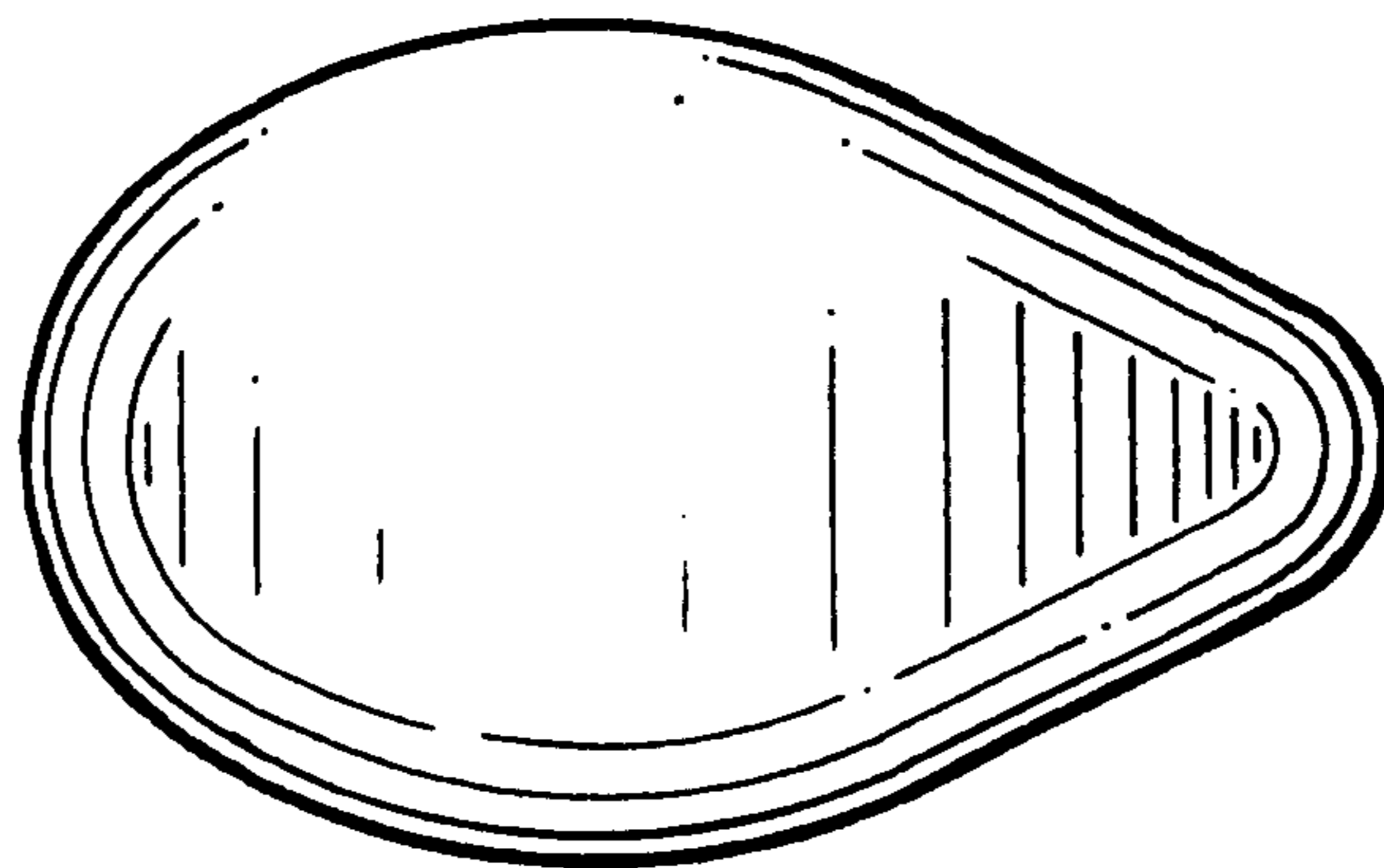

FIG. 6

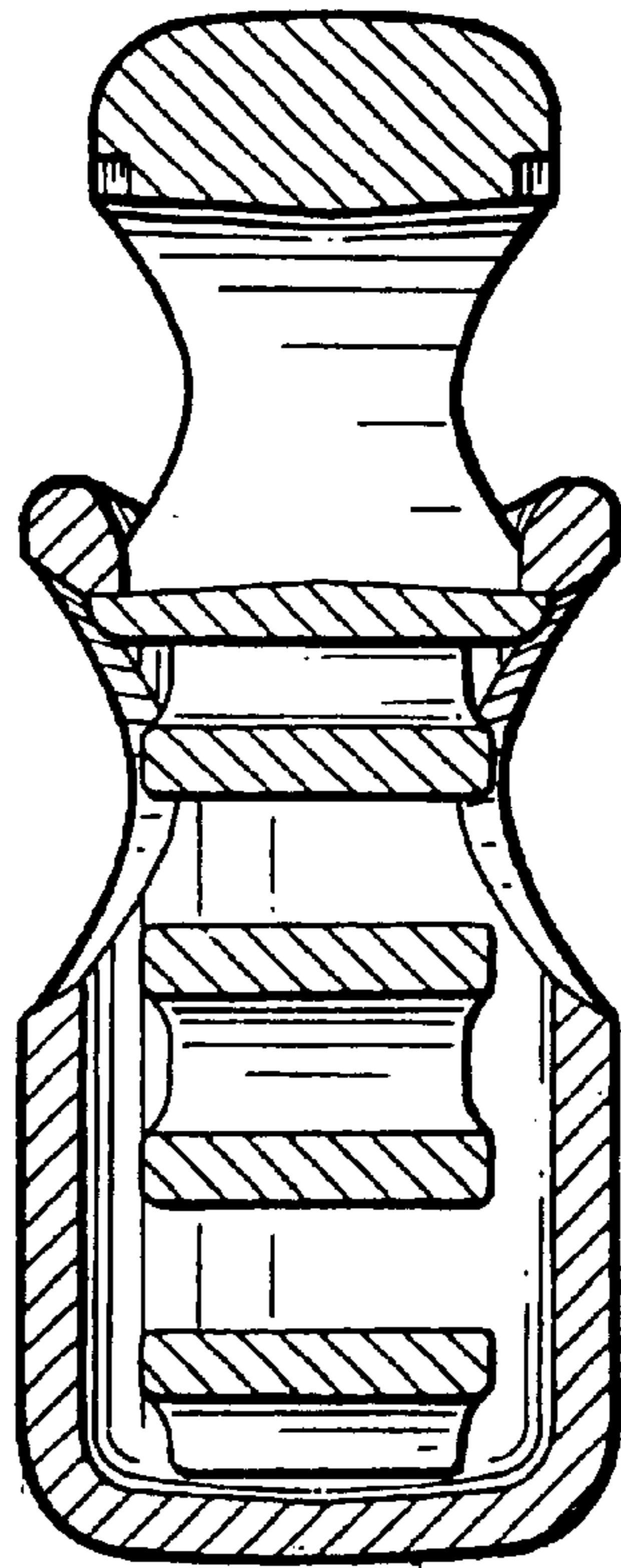

FIG. 7

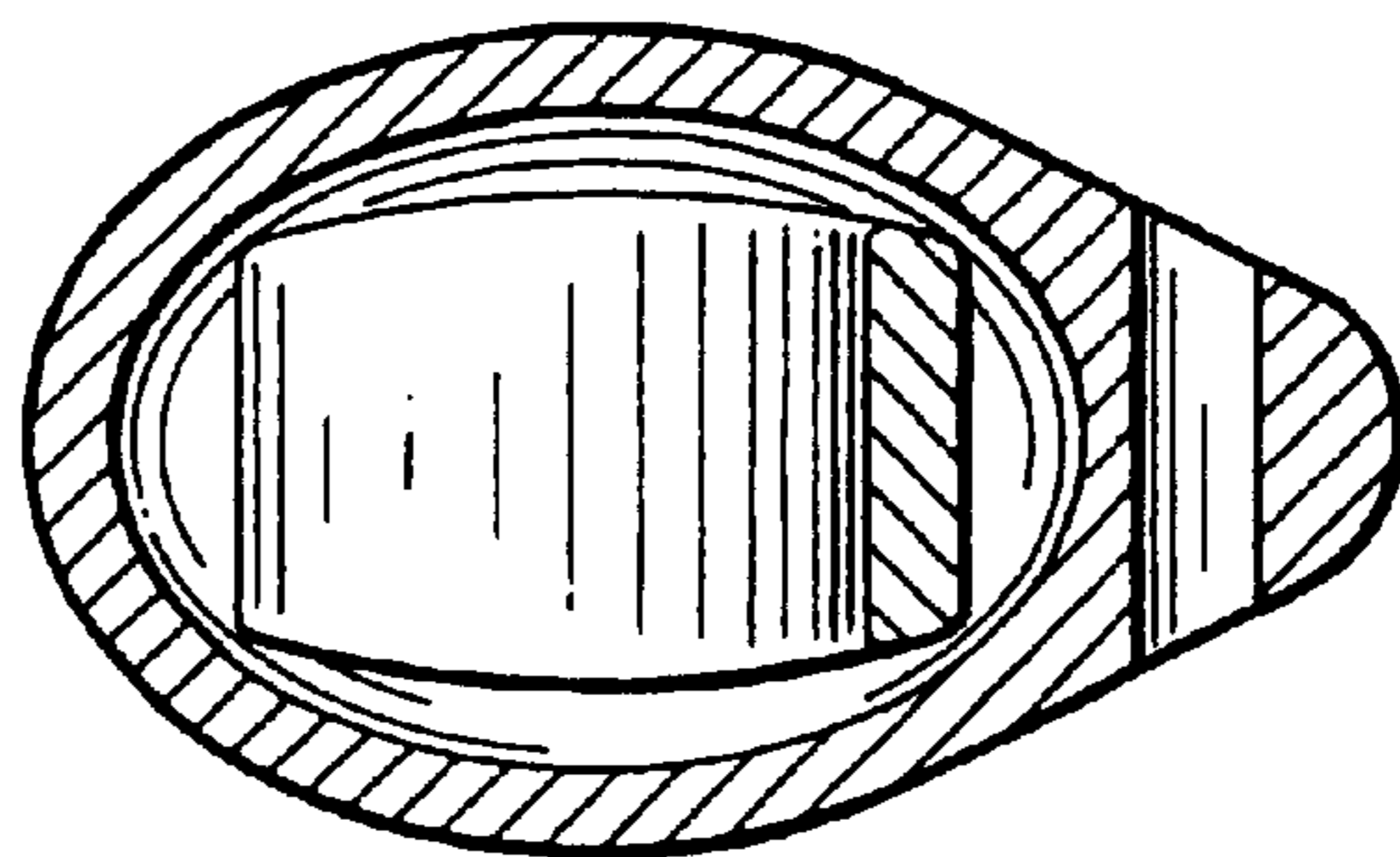

FIG. 8