



US00D481292S

(12) **United States Design Patent**
Chen

(10) **Patent No.:** **US D481,292 S**

(45) **Date of Patent:** **** Oct. 28, 2003**

(54) **GRIP FOR HAND TOOL**

D469,327 S * 1/2003 Chen D8/107

(76) Inventor: **Sherry Chen**, No. 52, Pien Hsing Lane,
Shiuetian Rd., Wur Shiang, Taichung
(TW)

* cited by examiner

Primary Examiner—Clare E. Heflin

(74) *Attorney, Agent, or Firm*—Bacon & Thomas, PLLC

(**) Term: **14 Years**

(57) **CLAIM**

(21) Appl. No.: **29/171,421**

The ornamental design for a “grip for hand tool”, as shown.

(22) Filed: **Nov. 22, 2002**

DESCRIPTION

(51) **LOC (7) Cl.** **08-02**

FIG. 1 shows a perspective view of the present design.

(52) **U.S. Cl.** **D8/107; D8/80**

FIG. 2 shows a right side elevational view of the present design.

(58) **Field of Search** D8/75–80, 107,
D8/303, 82–87, 21–29; 81/19–23, 26, 489,
177.1; 16/110.1

FIG. 3 shows a top plan view of the present design.

FIG. 4 shows a front elevational view of the present design.

FIG. 5 shows a bottom plan view of the present design.

(56) **References Cited**

FIG. 6 shows a left side elevational view of the present design; and,

FIG. 7 shows a rear elevational view of the present design.

U.S. PATENT DOCUMENTS

D431,987 S * 10/2000 Staton D8/75

D444,689 S * 7/2001 Staton et al. D8/80

1 Claim, 3 Drawing Sheets

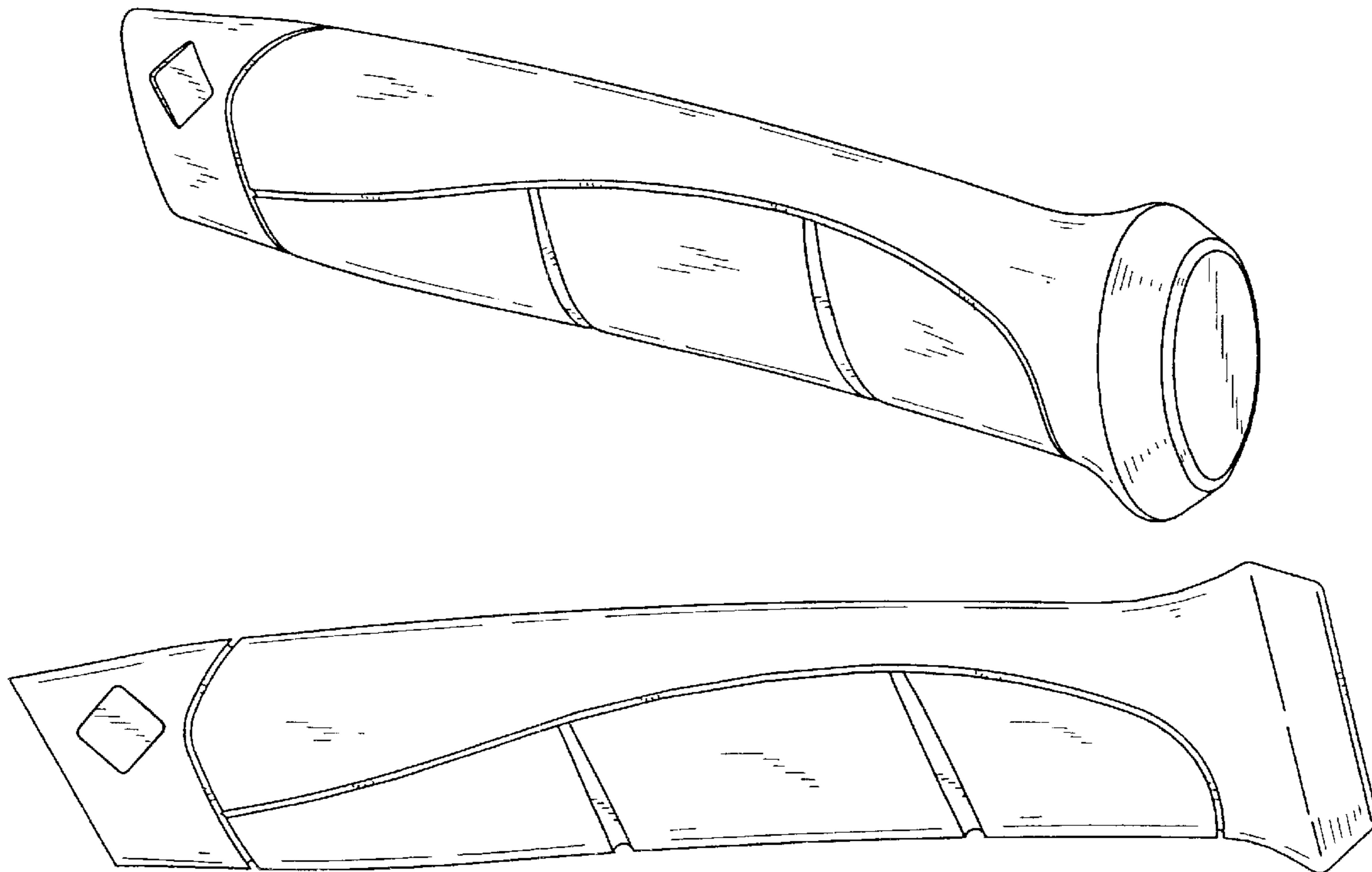

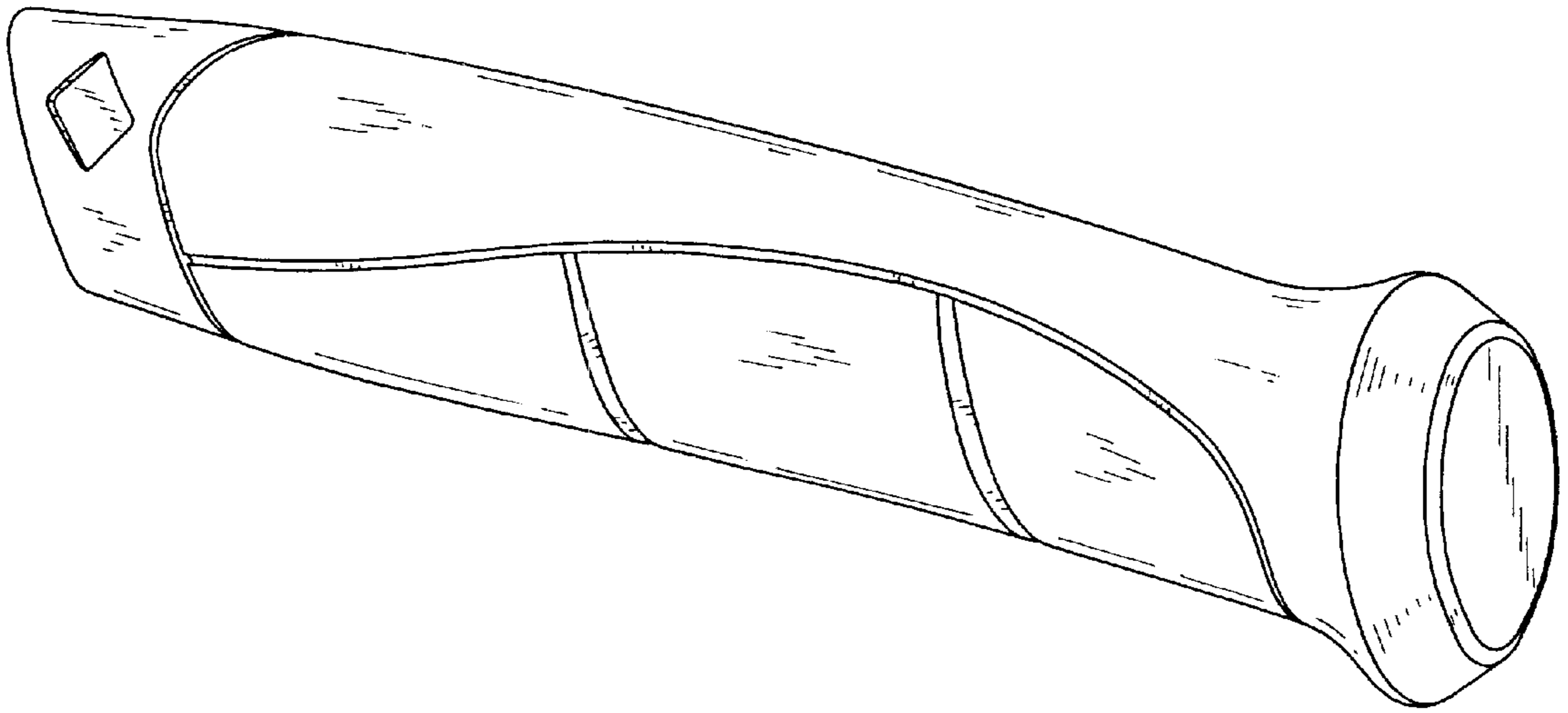

FIG. 1

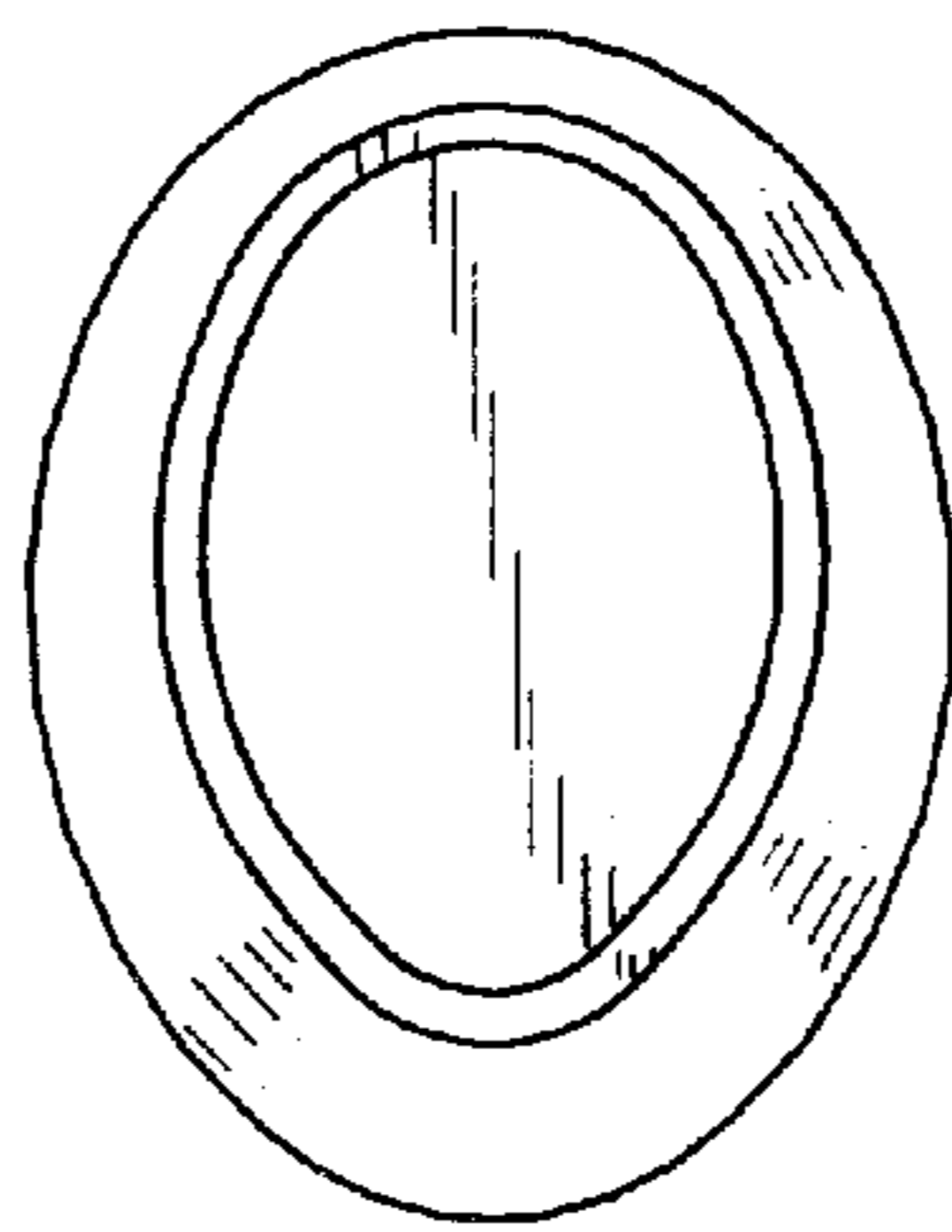

FIG. 2

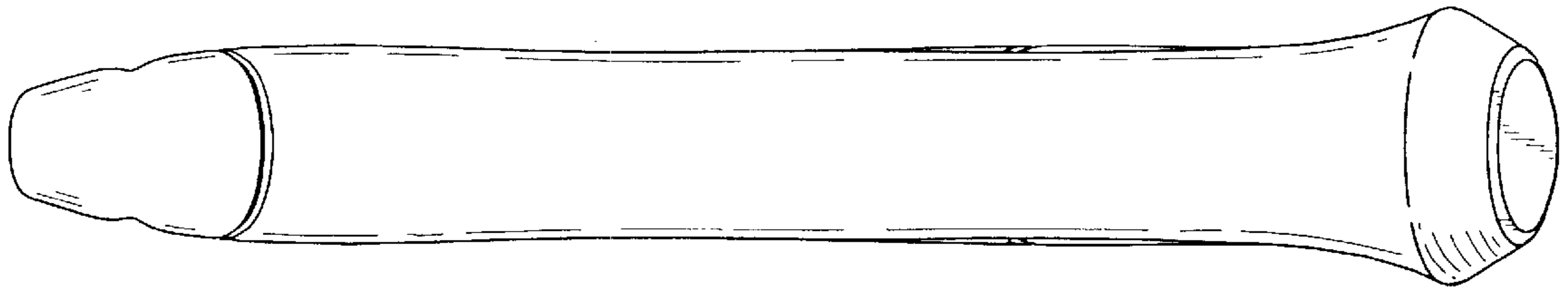

FIG. 3

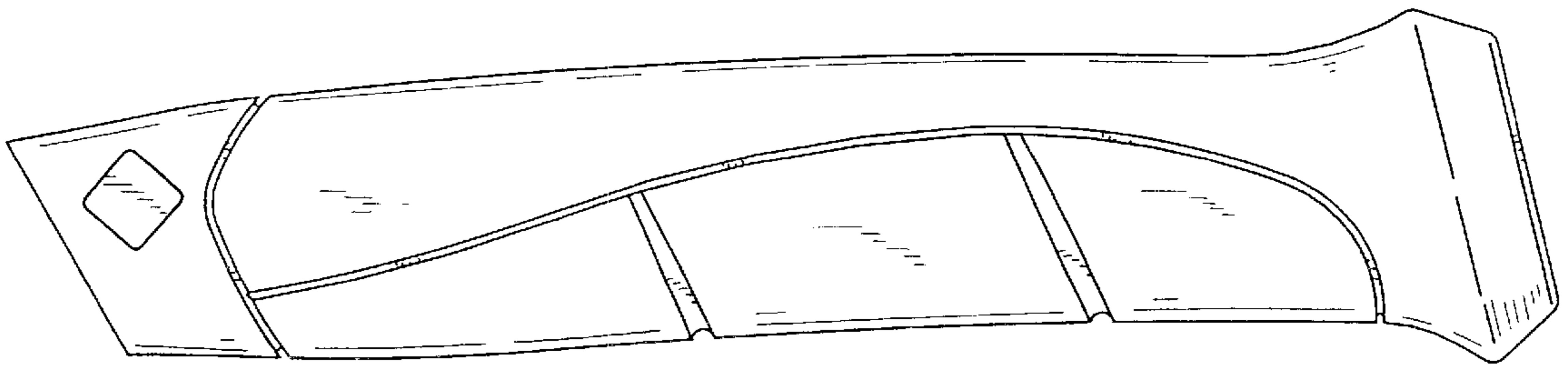

FIG. 4

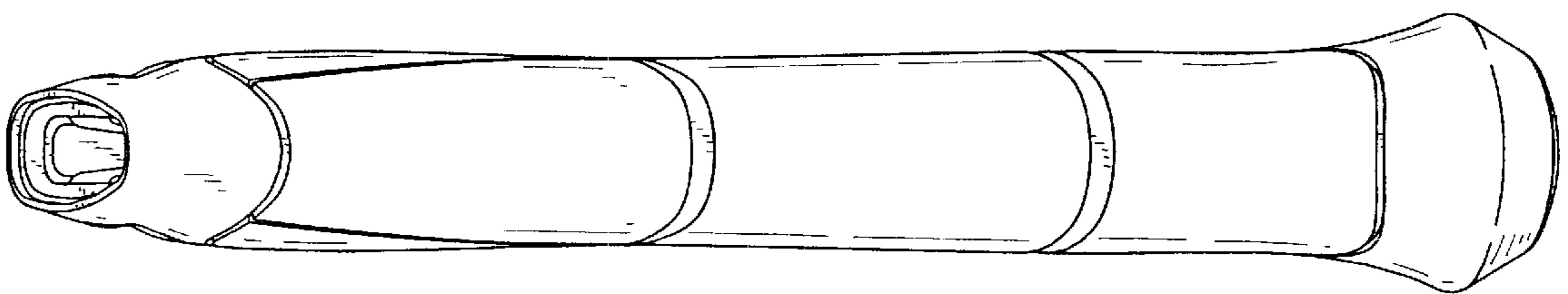

FIG. 5

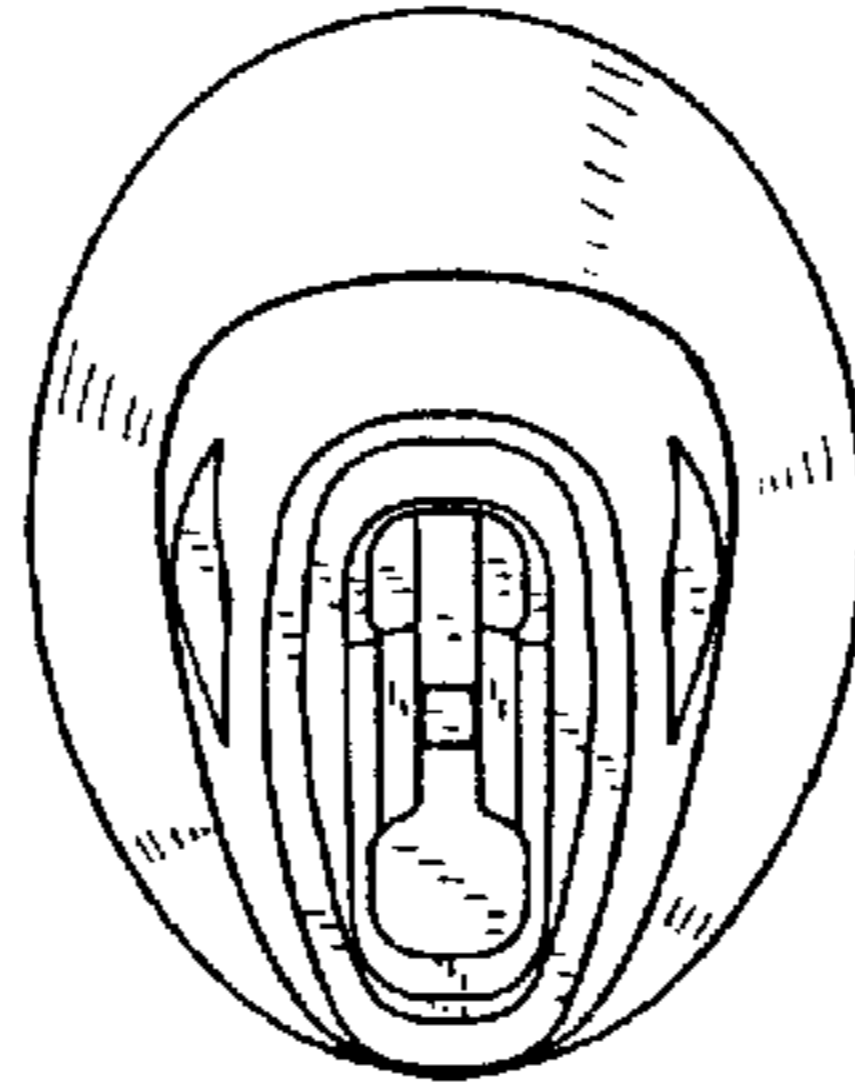

FIG. 6

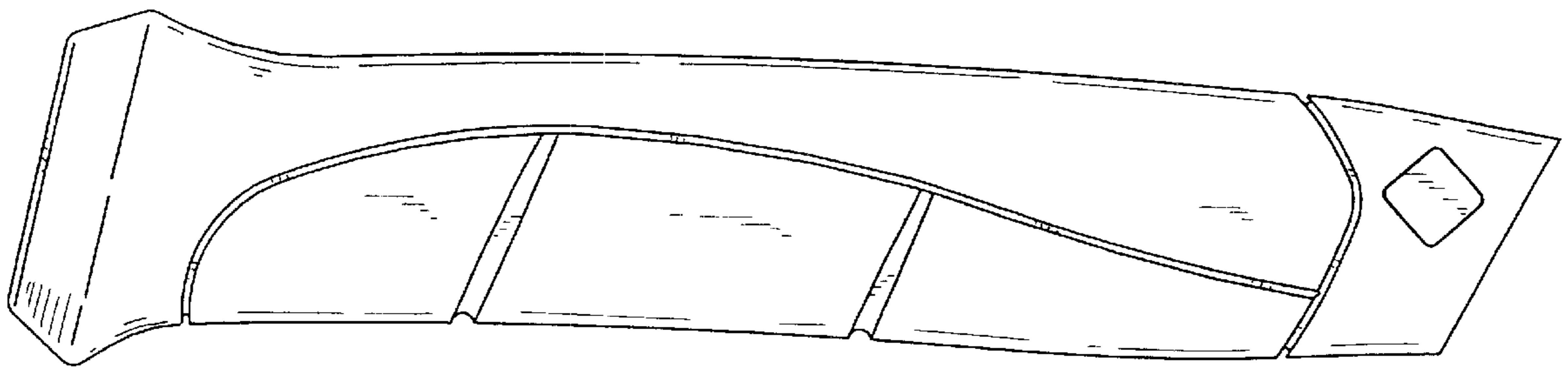

FIG. 7