



US00D481254S

(12) **United States Design Patent**
Lin

(10) **Patent No.:** **US D481,254 S**

(45) **Date of Patent:** **** Oct. 28, 2003**

(54) **HIGH FLOW CARAFE**

(76) **Inventor:** **Shin-Shuoh Lin**, 27022 Falling Leaf Dr., Laguna Hills, CA (US) 92653

(**) **Term:** **14 Years**

(21) **Appl. No.:** **29/160,567**

(22) **Filed:** **May 13, 2002**

(51) **LOC (7) Cl.** **07-01**

(52) **U.S. Cl.** **D7/318; D7/317**

(58) **Field of Search** D7/608, 321, 316,
D7/317, 318, 319, 598, 600, 507, 300.1,
312; 222/465.1, 572, 188, 505, 567; 210/282,
470; 220/739, 592.16, 592.27, 507; 215/12.1;
206/542, 543, 546

(56) **References Cited**

U.S. PATENT DOCUMENTS

D157,795 S	*	3/1950	Schwarz	D7/317
D192,642 S	*	4/1962	Douglas	D7/317
D200,978 S	*	4/1965	Seltz	D7/608
D201,839 S	*	8/1965	Erkers	D7/317
3,321,115 A	*	5/1967	Rendahl	222/505
D218,354 S	*	8/1970	Kikuchi	D7/317
D248,917 S	*	8/1978	Kikuchi	D7/321
D302,370 S	*	7/1989	Gibert	D7/317
5,249,703 A		10/1993	Karp		
D346,933 S		5/1994	Denny et al.		
D362,156 S		9/1995	Goto et al.		
D362,369 S		9/1995	Bridges		

D373,051 S		8/1996	Kramer et al.		
D386,948 S		12/1997	Wissinger		
D396,777 S		8/1998	Inoue		
D398,187 S		9/1998	Parker		
D401,466 S	*	11/1998	Joergensen	D7/318
D403,200 S	*	12/1998	Joergensen	D7/317
D411,713 S		6/1999	Bridges		
5,918,761 A		7/1999	Wissinger		
D416,757 S		11/1999	Ginuntoli		
D425,758 S		5/2000	Freed		
D454,468 S	*	3/2002	Mano	D7/318
D461,087 S	*	8/2002	Hatsumoto	D7/318
D464,522 S	*	10/2002	OaConnor et al.	D7/319

* cited by examiner

Primary Examiner—M. N. Pandozzi

(74) *Attorney, Agent, or Firm*—Gordon K. Anderson

(57) **CLAIM**

The ornamental design for a high flow carafe, as shown and described.

DESCRIPTION

FIG. 1 is a perspective view of a high flow carafe showing my new design;
FIG. 2 is a right side elevation view thereof;
FIG. 3 is a front elevation view thereof;
FIG. 4 is a rear elevation view thereof;
FIG. 5 is a left side elevation view thereof;
FIG. 6 is a top plan view thereof; and,
FIG. 7 is a bottom plan view thereof.

1 Claim, 2 Drawing Sheets

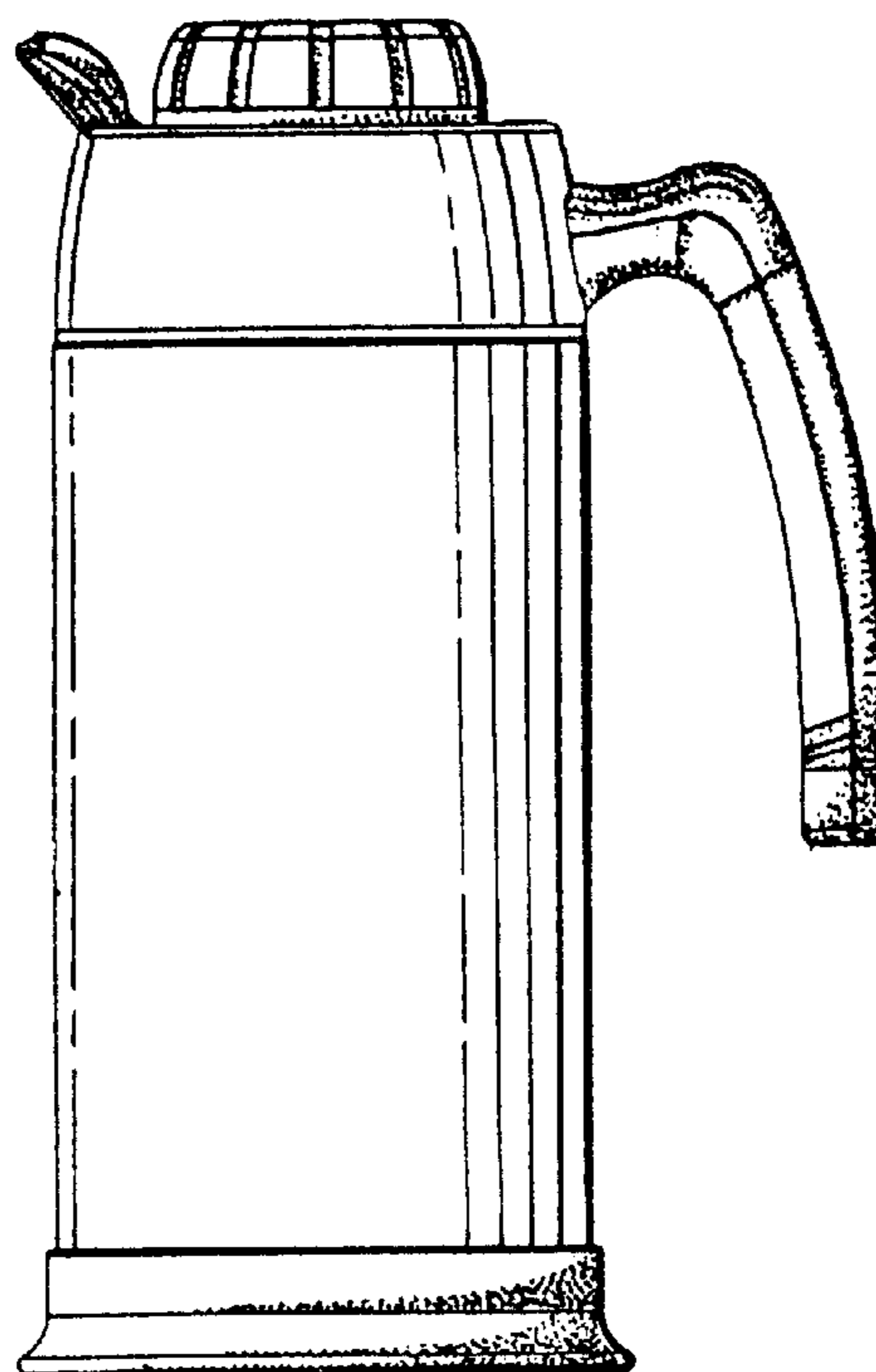
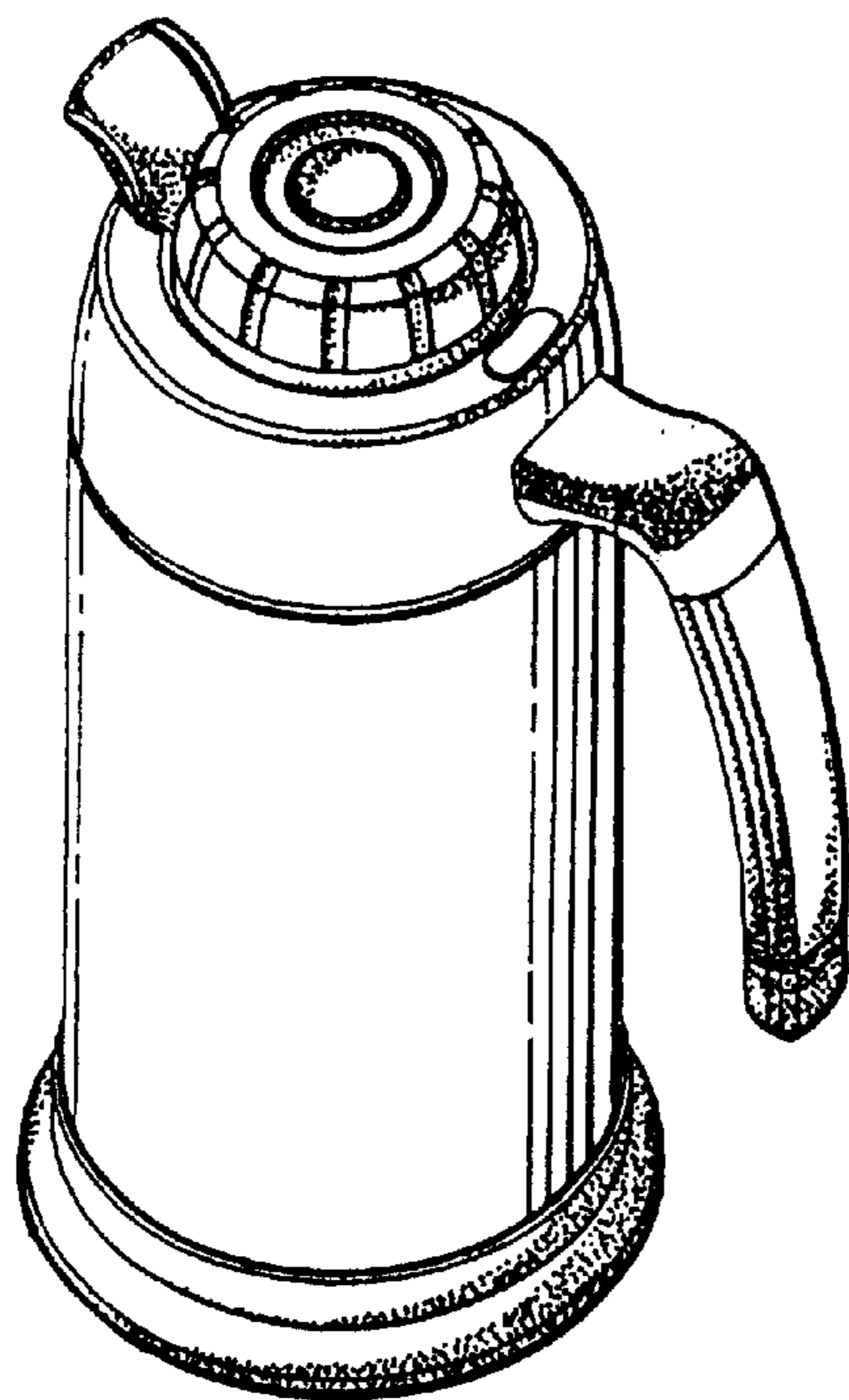

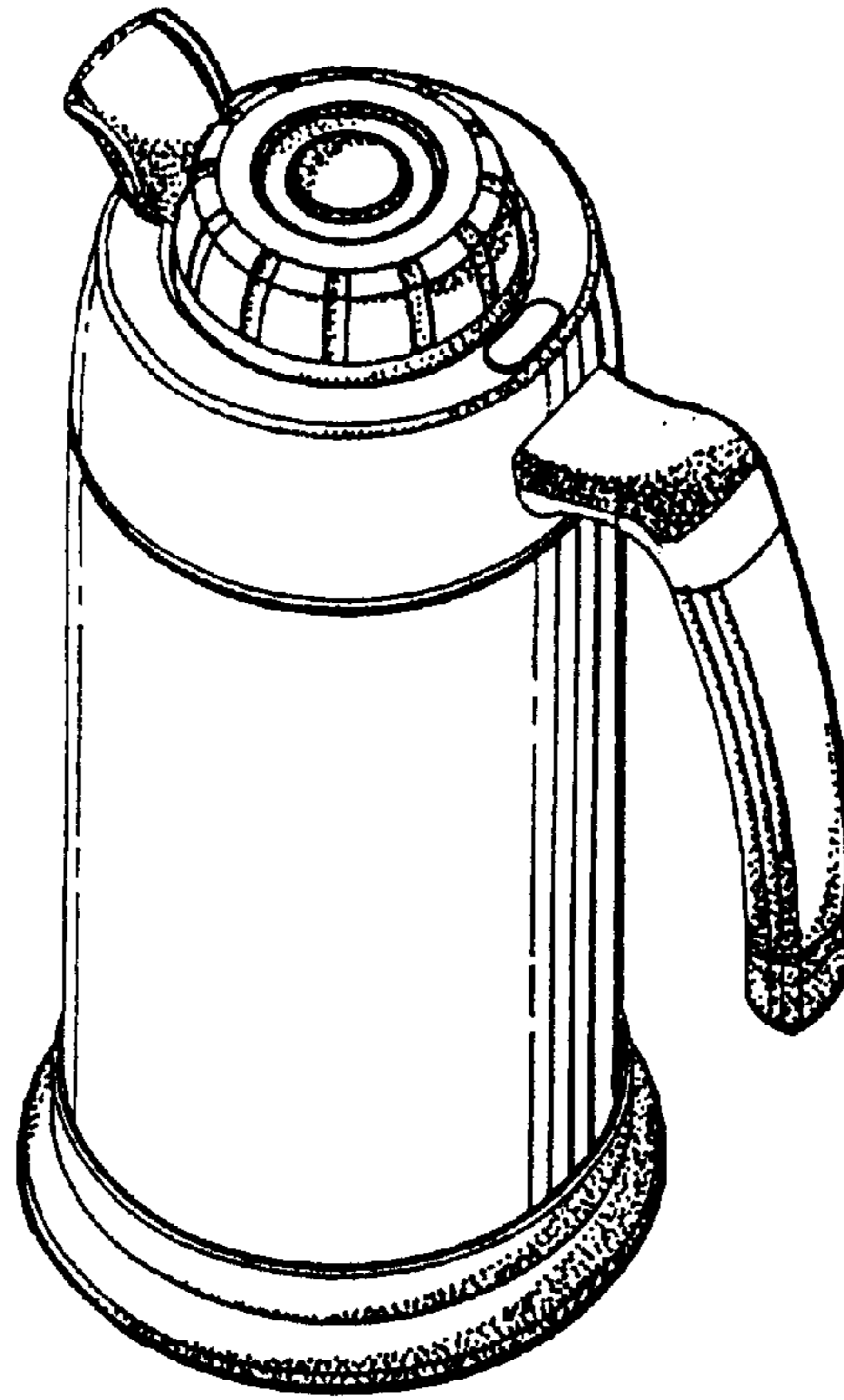

FIG. 1

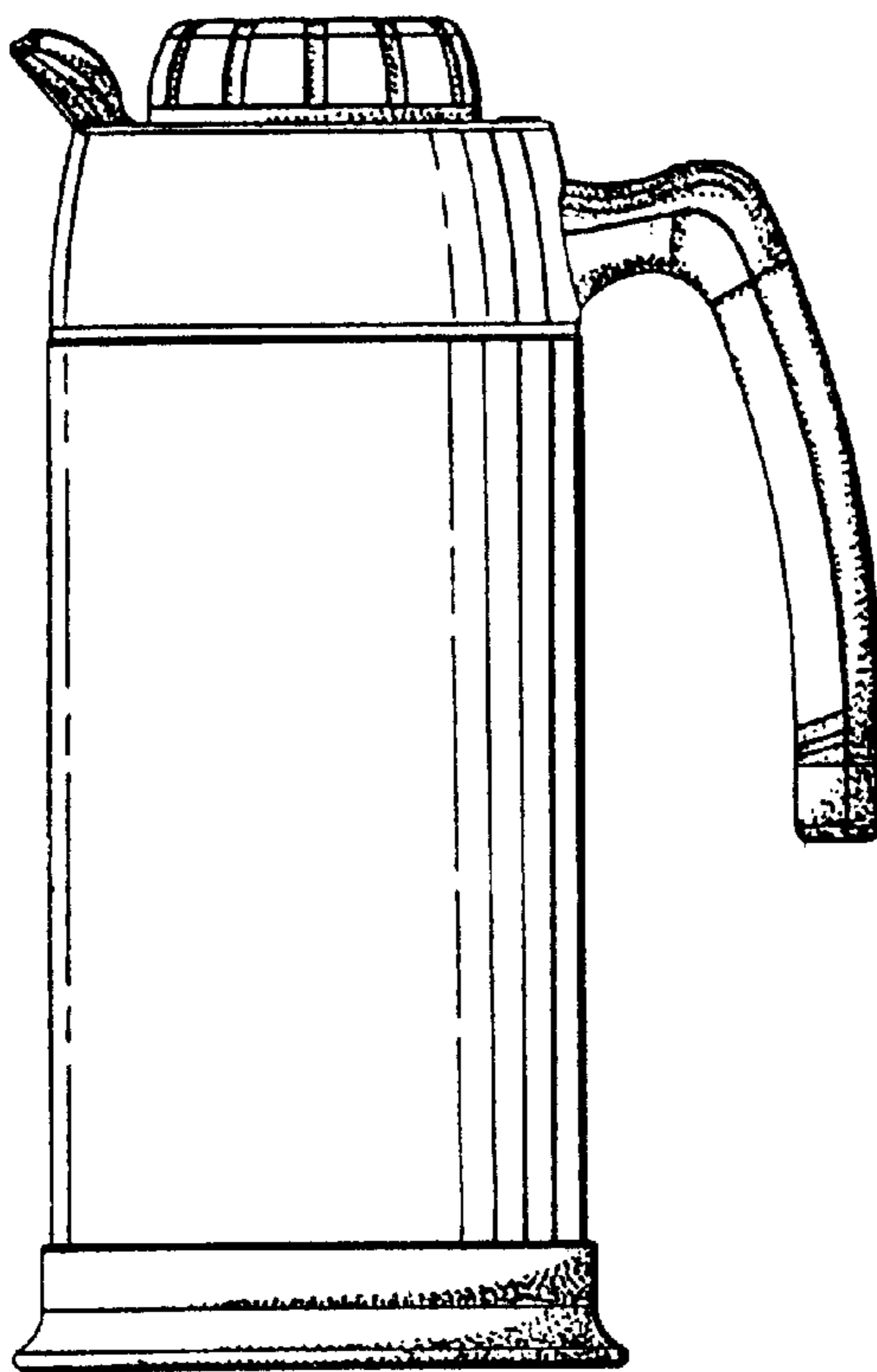

FIG. 2

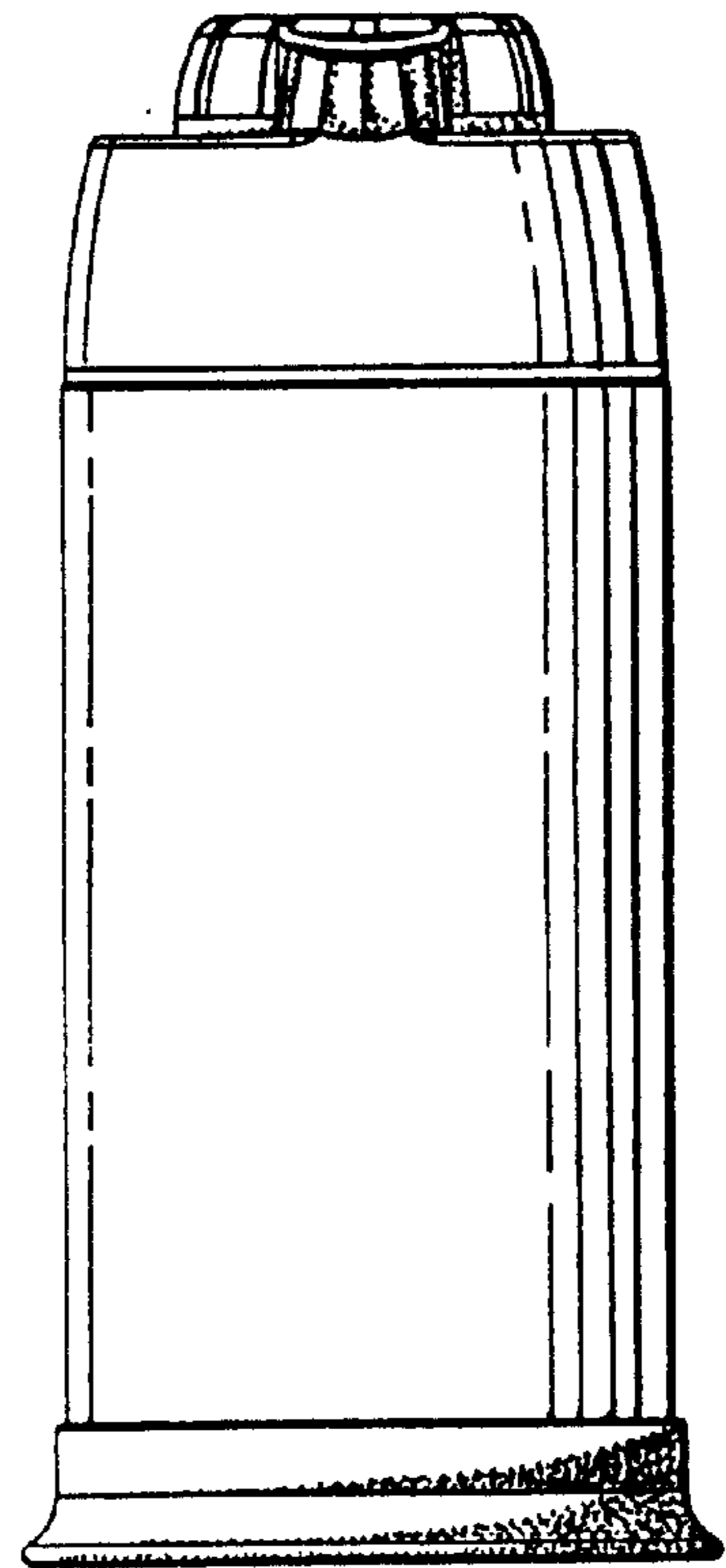

FIG. 3

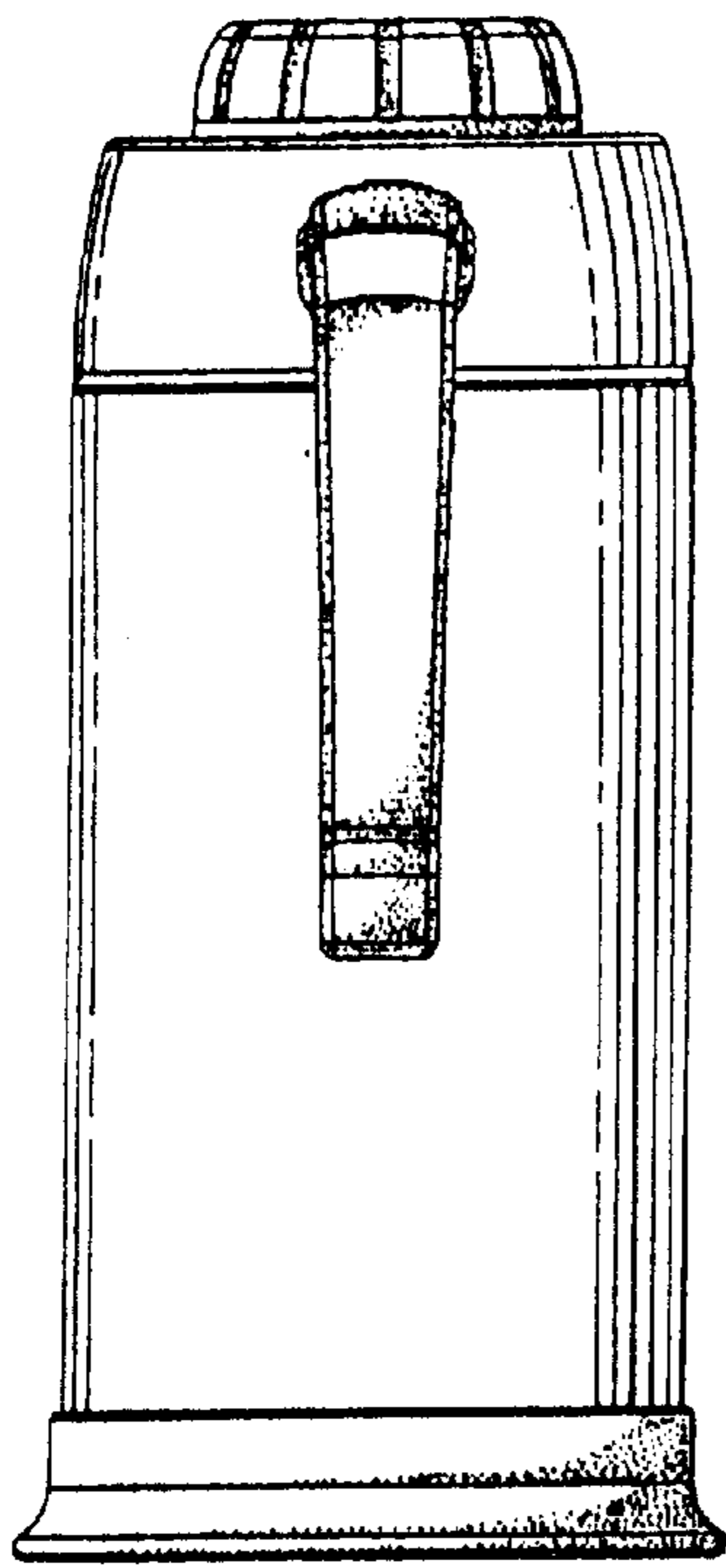

FIG. 4

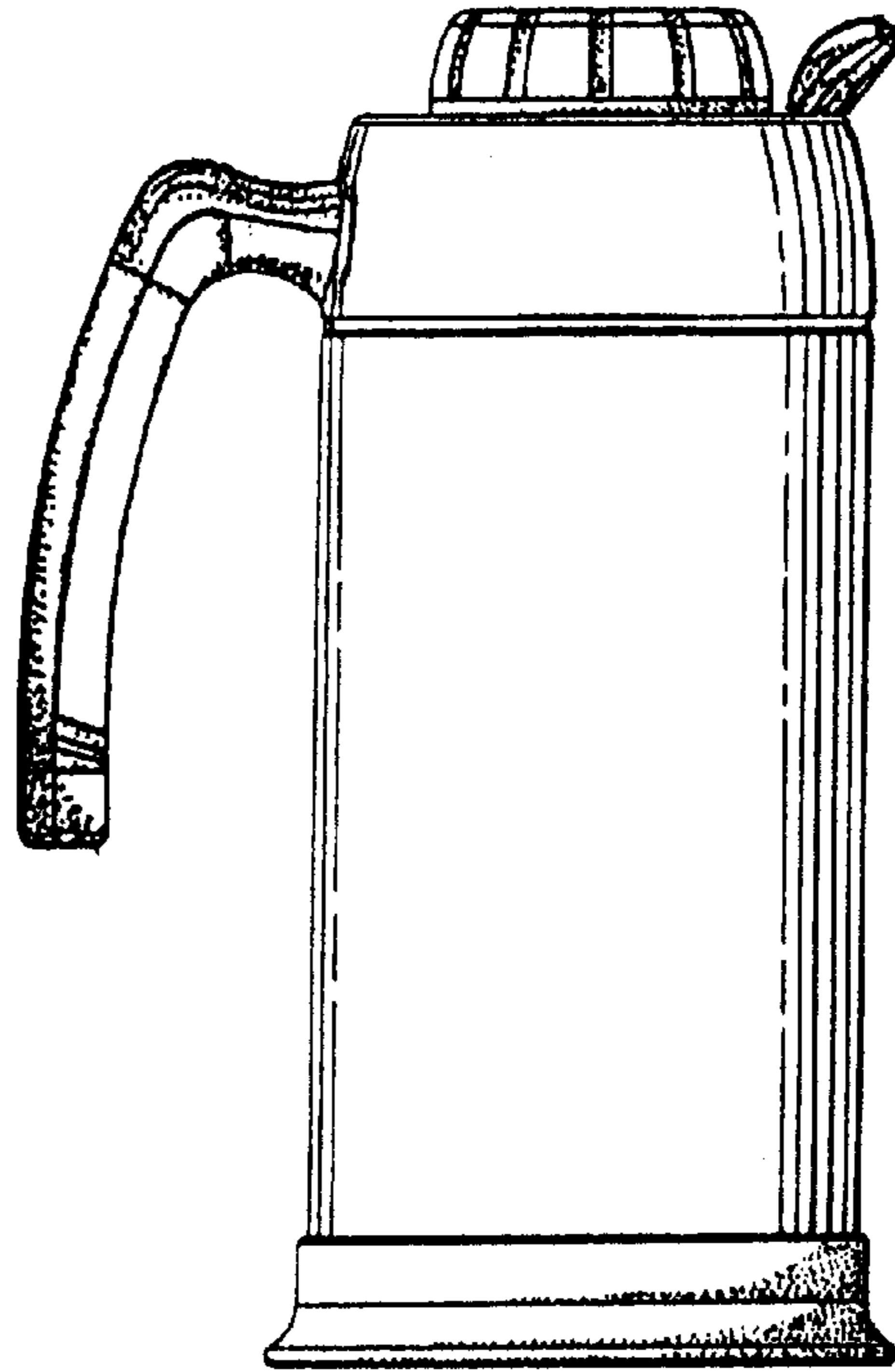

FIG. 5

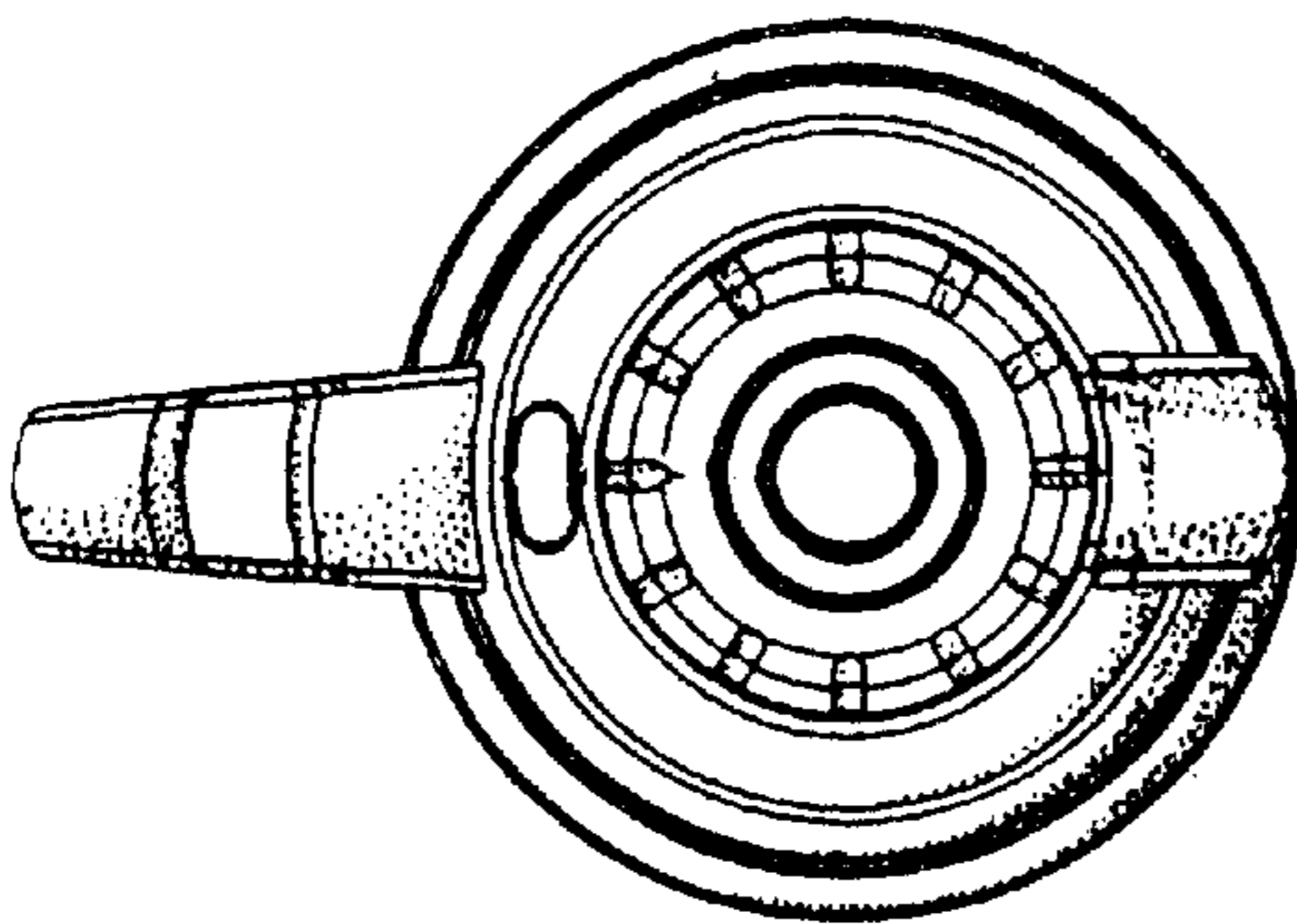

FIG. 6

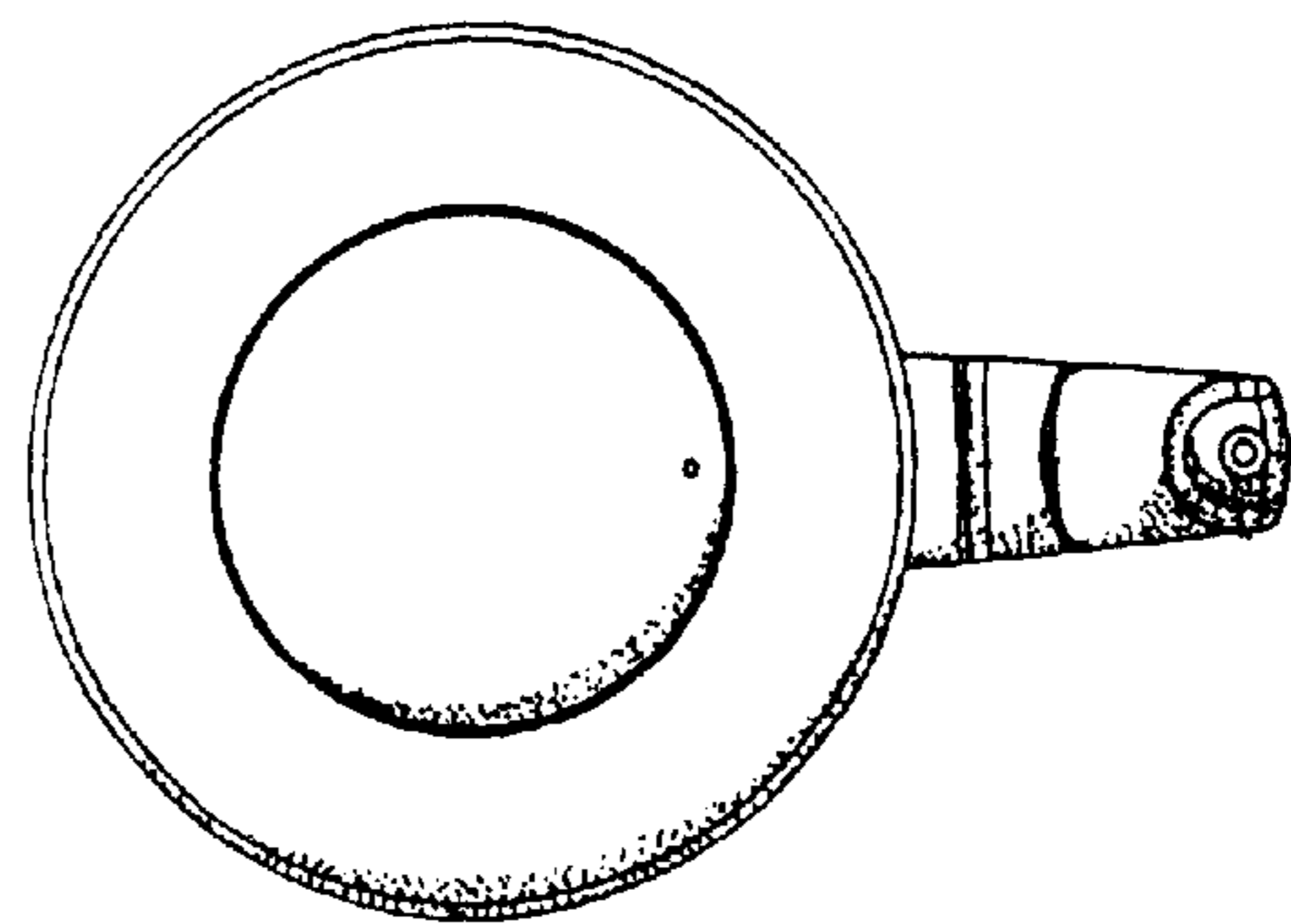

FIG. 7