



US00D481233S

(12) **United States Design Patent**
Post et al.

(10) **Patent No.: US D481,233 S**
(45) **Date of Patent: ** Oct. 28, 2003**

(54) **PORTION OF MESH DRAWER AND FRAME**

(75) Inventors: **R. Neal Post**, Springfield, IL (US);
Christopher Hardy, Springfield, IL (US)

(73) Assignee: **Design Ideas, Ltd.**, Springfield, IL (US)

(**) Term: **14 Years**

(21) Appl. No.: **29/176,610**

(22) Filed: **Feb. 27, 2003**

Related U.S. Application Data

(63) Continuation-in-part of application No. 29/148,906, filed on Sep. 28, 2001.

(51) **LOC (7) Cl. 06-06**

(52) **U.S. Cl. D6/510; D6/476; D6/479**

(58) **Field of Search** D6/396, 397, 436, D6/437, 411, 415, 449, 455-469, 475, 476; 108/59, 91, 92, 93, 94; 211/11, 13.1, 85.1, 85.2, 85.4, 70, 78, 107, 131.1, 133.2, 163, 164, 181.1, 182

(56) **References Cited**

U.S. PATENT DOCUMENTS

- 297,382 A 4/1884 Golding
- 887,097 A 5/1908 Kimber
- 1,098,053 A * 5/1914 Porter 220/485
- RE16,431 E 9/1926 Kratzer
- D152,141 S * 12/1948 Crawford et al. D3/306
- 2,502,781 A * 4/1950 Erikson 220/491
- 2,825,481 A 3/1958 Glenney
- D182,349 S 4/1958 Alvord
- 2,905,519 A 9/1959 O'Neil
- D189,544 S 1/1961 Harris
- D189,550 S 1/1961 Alvord
- D194,513 S 2/1963 Sparling
- D204,314 S 4/1966 Bright
- D207,308 S 4/1967 Bell
- D227,964 S 7/1973 Propst
- 3,868,123 A 2/1975 Berg et al.

- D267,395 S 12/1982 Groenewold et al.
- 4,509,805 A 4/1985 Welsch et al.
- D300,488 S 4/1989 Yoshikawa
- D303,444 S 9/1989 Yoshikawa
- D328,993 S 9/1992 Rosenthal
- D329,556 S * 9/1992 Brussing D6/468
- D329,765 S 9/1992 Ackley et al.
- D330,813 S 11/1992 Spitzer et al.
- D340,369 S 10/1993 Dokoupil et al.
- D341,459 S * 11/1993 Yang D34/21
- D360,531 S 7/1995 Griffith
- D365,226 S 12/1995 Goebel
- D370,144 S 5/1996 Insalaco et al.
- D373,039 S 8/1996 Cohen et al.
- 5,605,344 A 2/1997 Insalaco et al.
- 5,673,984 A 10/1997 Insalaco et al.
- 5,685,442 A 11/1997 Yoshino et al.
- 5,810,179 A 9/1998 Kleiman
- D408,175 S 4/1999 Daniels et al.
- D409,866 S 5/1999 West
- D411,045 S 6/1999 Morandi
- D418,998 S 1/2000 Glassenberg
- D419,302 S 1/2000 Hardy et al.
- 6,032,965 A * 3/2000 Sabounjian 280/47.35
- D430,375 S 8/2000 Tezak
- D432,752 S 10/2000 Andujar et al.
- D434,074 S 11/2000 Hardy
- D436,239 S 1/2001 Walsh
- D436,461 S 1/2001 Walker
- D436,466 S * 1/2001 Luong et al. D6/478
- D438,402 S * 3/2001 Walsh D6/449
- D445,281 S 7/2001 Tsong-Yow
- D450,481 S 11/2001 Post
- D451,675 S 12/2001 Hardy et al.
- D453,027 S 1/2002 Andujar
- D455,029 S 4/2002 Gusdorf
- D460,848 S * 7/2002 Tzeng D34/21
- D462,543 S 9/2002 Childers
- D465,947 S 11/2002 Andersen et al.

FOREIGN PATENT DOCUMENTS

TW 086202707 2/1998

OTHER PUBLICATIONS

The Container Store Catalog, Elfa Drawer Units, pp. 4,5,8, 9,10,16,17,31, 1999.*
The Container Store, The Ultimate Planning Guide, revised Nov. 2001.

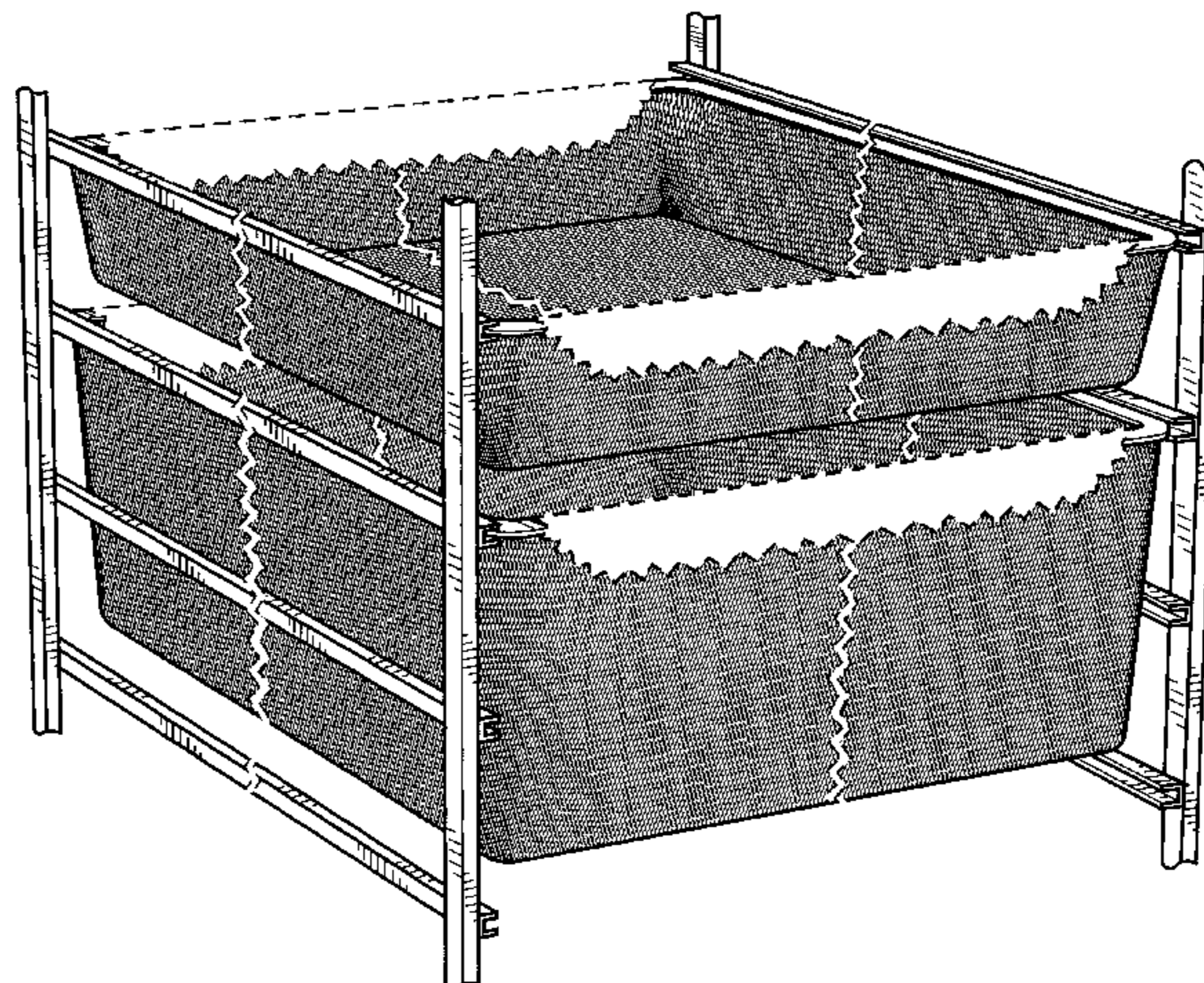

1995 Design Ideas Catalogue, pp. cover page, 24, 26, 27 and 29.

1997 Design Ideas Holiday Catalogue, pp. cover page, 62 and 63.

HK Enterprise, Oct. 1999, p. 98, Item NH-11.

* cited by examiner

Primary Examiner—Cathron C. Brooks

(74) *Attorney, Agent, or Firm*—SAIDMAN DesignLaw Group

(57) **CLAIM**

The ornamental design for a portion of mesh drawer and frame, as shown and described.

DESCRIPTION

FIG. 1 is a perspective view of a first embodiment of a portion of mesh drawer and frame showing our new design, wherein 1- and 2- runner drawers are supported by a frame; FIG. 2 is a front view thereof, the rear view being identical thereto;

FIG. 3 is a side view thereof, the opposite side view being identical thereto;

FIG. 4 is a front view of a second embodiment thereof, wherein a 1-runner drawer is supported by a frame, the rear view being identical thereto;

FIG. 5 is a side view thereof, the opposite side view being identical thereto;

FIG. 6 is a top view of the embodiments of FIGS. 1-5, 16-23, 30, and 31;

FIG. 7 is a bottom view of the embodiments of FIGS. 4, 5, 16, 17, 20, and 21;

FIG. 8 is a front view of a third embodiment thereof wherein a 2-runner drawer is supported by a frame, the rear view being identical thereto;

FIG. 9 is a side view thereof, the opposite side view being identical thereto;

FIG. 10 is a top view of the embodiments of FIGS. 8, 9, and 24-27;

FIG. 11 is a bottom view of the embodiments of FIGS. 1-3, 8, 9, 24, 25, 30, and 31;

FIG. 12 is a front view of a fourth embodiment thereof, wherein a 3-runner drawer is supported by a frame, the rear view being identical thereto;

FIG. 13 is a side view thereof, the opposite side view being identical thereto;

FIG. 14 is a top view of the embodiments of FIGS. 12, 13, 28, and 29;

FIG. 15 is a bottom view of the embodiments of FIGS. 12, 13, 18, 19, 22, 23, and 26-29;

FIG. 16 is a front view of a fifth embodiment thereof, wherein two 1-runner drawers are supported by a frame, the rear view being identical thereto;

FIG. 17 is a side view thereof, the opposite side view being identical thereto;

FIG. 18 is a front view of a sixth embodiment thereof, wherein 1- and 3-runner drawers are supported by a frame, the rear view being identical thereto;

FIG. 19 is a side view thereof, the opposite side view being identical thereto;

FIG. 20 is a front view of a seventh embodiment thereof, wherein three 1-runner drawers are supported by a frame, the rear view being identical thereto;

FIG. 21 is a side view thereof, the opposite side view being identical thereto;

FIG. 22 is a front view of an eighth embodiment thereof wherein 1-, 2-, and 3-runner drawers are supported by a frame, the rear view being identical thereto;

FIG. 23 is a side view thereof, the opposite side view being identical thereto;

FIG. 24 is a front view of a ninth embodiment thereof, wherein two 2-runner drawers are supported by a frame, the rear view being identical thereto;

FIG. 25 is a side view thereof, the opposite side view being identical thereto;

FIG. 26 is a front view of a tenth embodiment thereof, wherein 2- and 3-runner drawers are supported by a frame, the rear view being identical thereto;

FIG. 27 is a side view thereof, the opposite side view being identical thereto;

FIG. 28 is a front view of an eleventh embodiment thereof, wherein two 3-runner drawers are supported by a frame, the rear view being identical thereto;

FIG. 29 is a side view thereof, the opposite side view being identical thereto;

FIG. 30 is a front view of a twelfth embodiment thereof, wherein a 1-runner and two 2-runner drawers are supported by a frame, the rear view being identical thereto;

FIG. 31 is a side view thereof, the opposite side view being identical thereto;

FIG. 32 is a perspective view of a thirteenth embodiment of a portion of mesh drawer and frame showing our new design, wherein one 3- and 2-runner drawers are supported by a frame;

FIG. 33 is a front view thereof, the rear view being identical thereto;

FIG. 34 is a side view thereof, the opposite side view being identical thereto;

FIG. 35 is a front view of a fourteenth embodiment thereof, the rear view being identical thereto;

FIG. 36 is a side view thereof, the opposite side view being identical thereto;

FIG. 37 is a top view of a embodiments of FIGS. 32-36, 47-54, and 61-62;

FIG. 38 is a bottom view of the embodiments of FIGS. 35, 36, and 47-48, and 51;

FIG. 39 is a front view of a fifteenth embodiment thereof, the rear view being identical thereto;

FIG. 40 is a side view thereof, the opposite side view being identical thereto;

FIG. 41 is a top view of the embodiments of FIGS. 39-40 and 55-58;

FIG. 42 is a bottom view of the embodiments of FIGS. 32-34, 39-40, 55-56, and 61-62;

FIG. 43 is a front view of a sixteenth embodiment thereof, the rear view being identical thereto;

FIG. 44 is a side view thereof, the opposite side view being identical thereto;

FIG. 45 is a top view of the embodiments of FIGS. 43-44 and 59-60;

FIG. 46 is a bottom view of the embodiments of FIGS. 43-44, 49-50, 53-54, and 57-60;

FIG. 47 is a front view of a seventeenth embodiment thereof, the rear view being identical thereto;

FIG. 48 is a side view thereof, the opposite side view being identical thereto;

FIG. 49 is a front view of an eighteenth embodiment thereof, the rear view being identical thereto;

FIG. 50 is a side view thereof, the opposite side view being identical thereto;

FIG. 51 is a front view of a nineteenth embodiment thereof, the rear view being identical thereto;

FIG. 52 is a side view thereof, the opposite side view being identical thereto;

FIG. 53 is a front view of a twentieth embodiment thereof, the rear view being identical thereto;

FIG. 54 is a side view thereof, the opposite side view being identical thereto;

FIG. 55 is a front view of a twenty-first embodiment thereof, the rear view being identical thereto;

FIG. 56 is a side view thereof, the opposite side view being identical thereto;

FIG. 57 is a front view of a twenty-second embodiment thereof, the rear view being identical thereto;

FIG. 58 is a side view thereof, the opposite side view being identical thereto;

FIG. 59 is a front view of a twenty-third embodiment thereof, the rear view being identical thereto;

FIG. 60 is a side view thereof, the opposite side view being identical thereto;

FIG. 61 is a front view of a twenty-fourth embodiment thereof, the rear view being identical thereto;

FIG. 62 is a side view thereof, the opposite side view being identical thereto; and,

FIG. 63 is an enlarged, fragmentary view of an exemplary wire mesh used in the foregoing embodiments of FIGS. 1-62.

The jagged broken lines surrounding the somewhat U-shaped openings in the front and rear views of the drawers indicate that no particular handle shape is being claimed, represent boundaries of the claimed design and form no part of the claimed design.

The pairs of closely adjacent, spaced jagged broken lines in the drawings form no part of the claimed design and the portions between such pairs of jagged, broken lines are broken away to disclose indeterminate length. The mesh material that may be visible through each of the somewhat U-shaped openings, between the jagged lines, and through the holes in the mesh has been removed for clarity. The wavy end portions of the vertical frame members indicate fragmentary, indeterminate length and form no part of the claimed design.

1 Claim, 33 Drawing Sheets

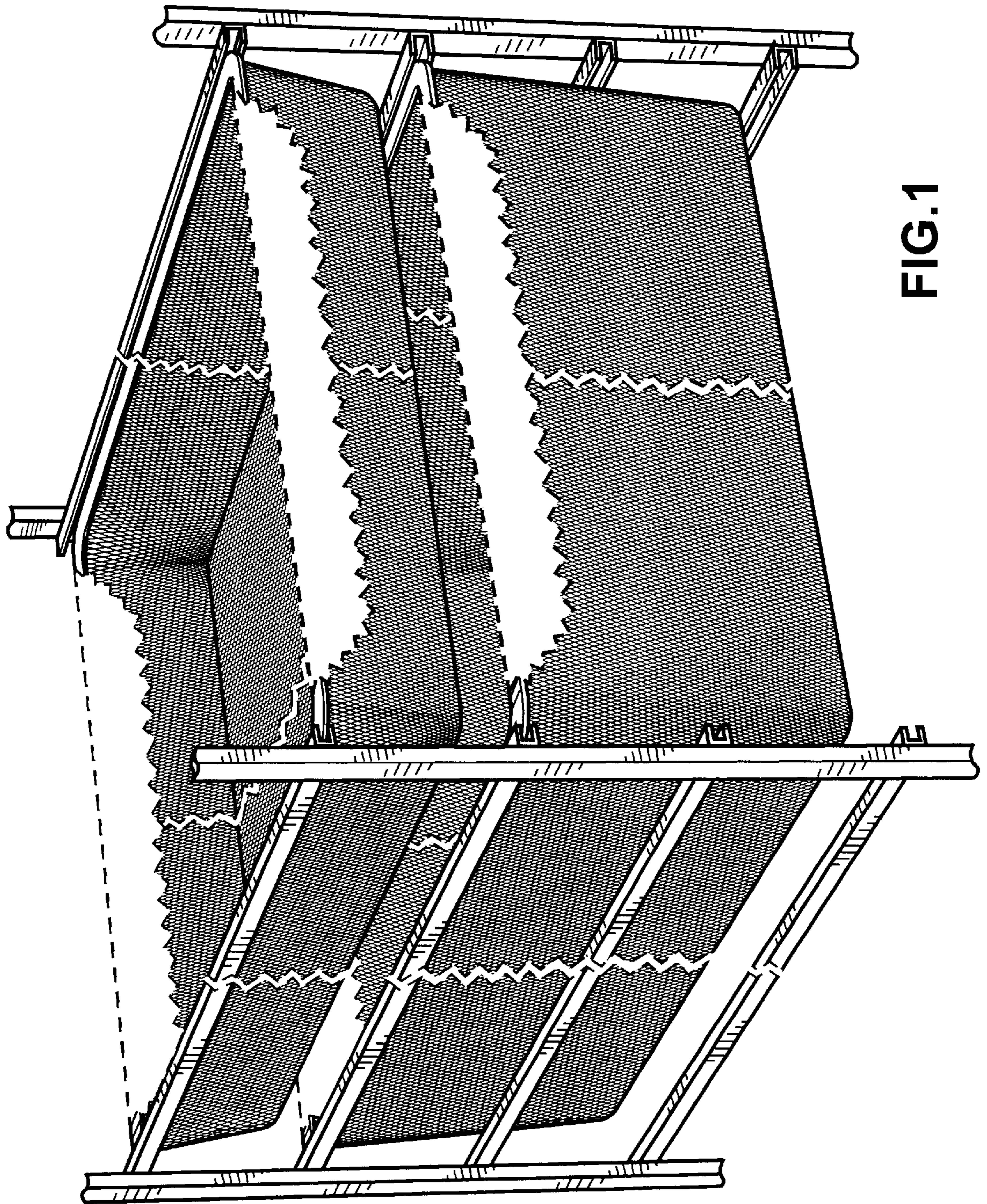

FIG.1

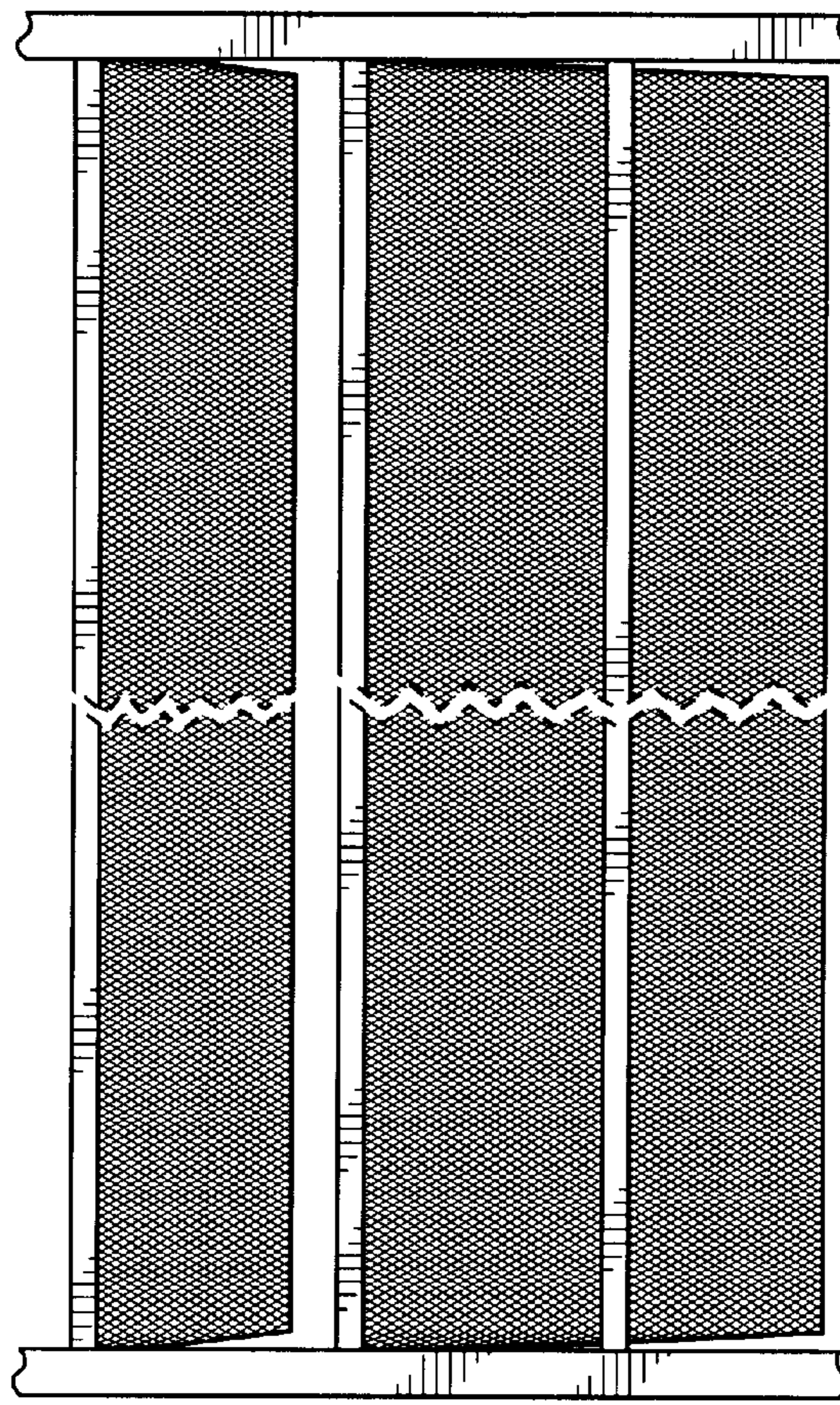

FIG.3

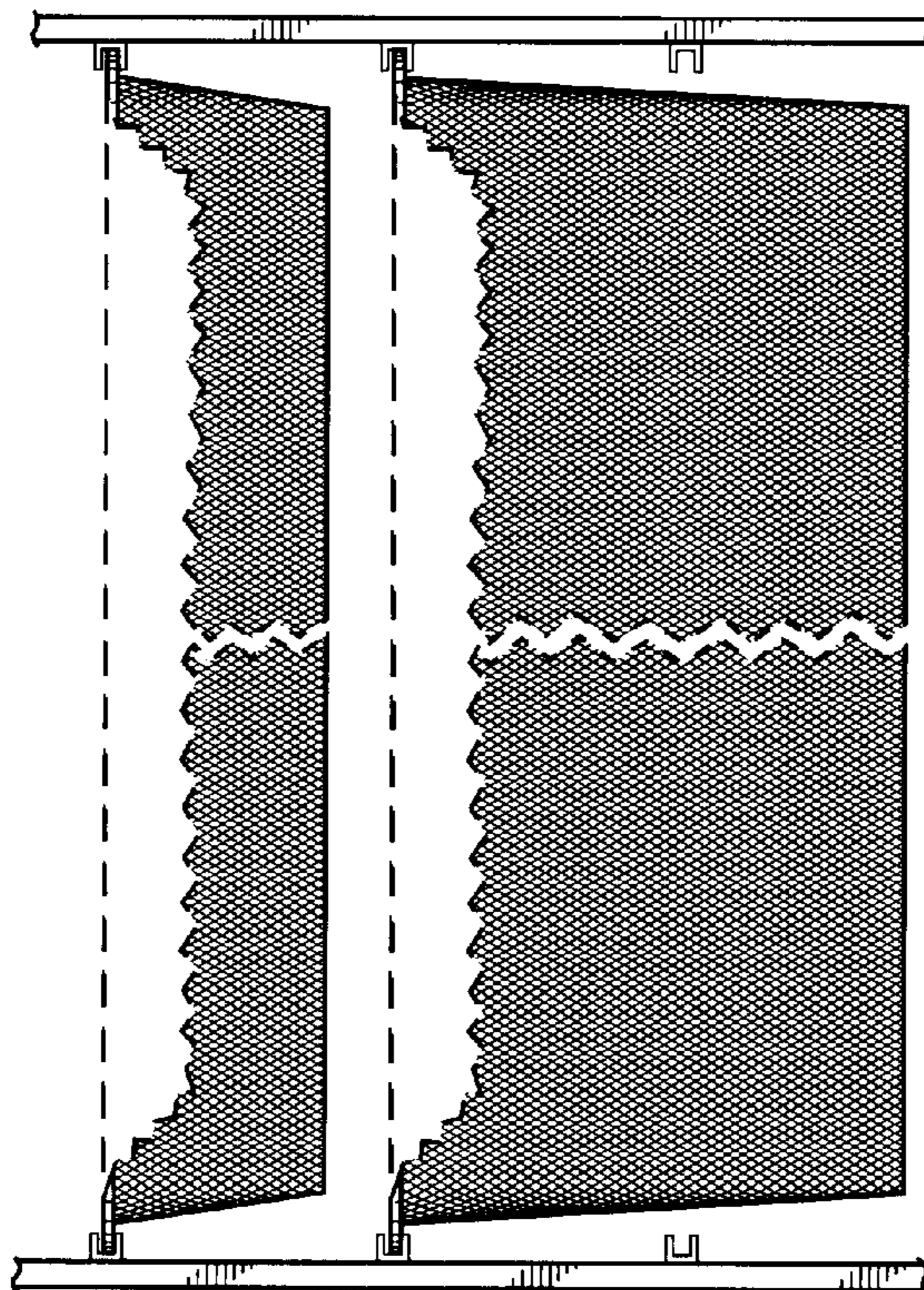

FIG.2

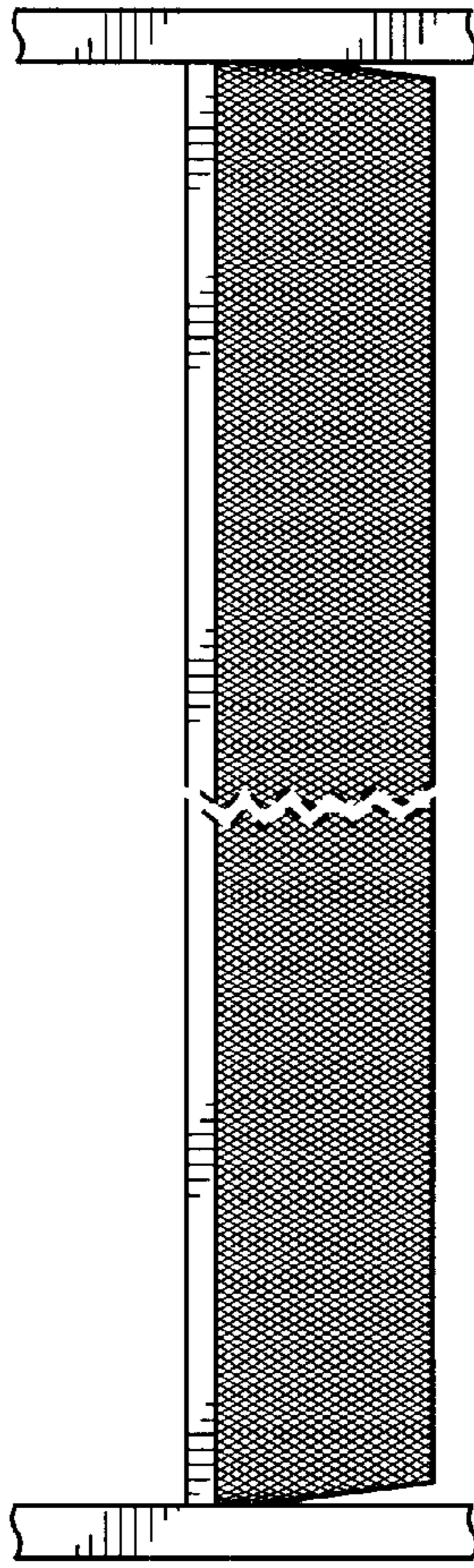

FIG. 5

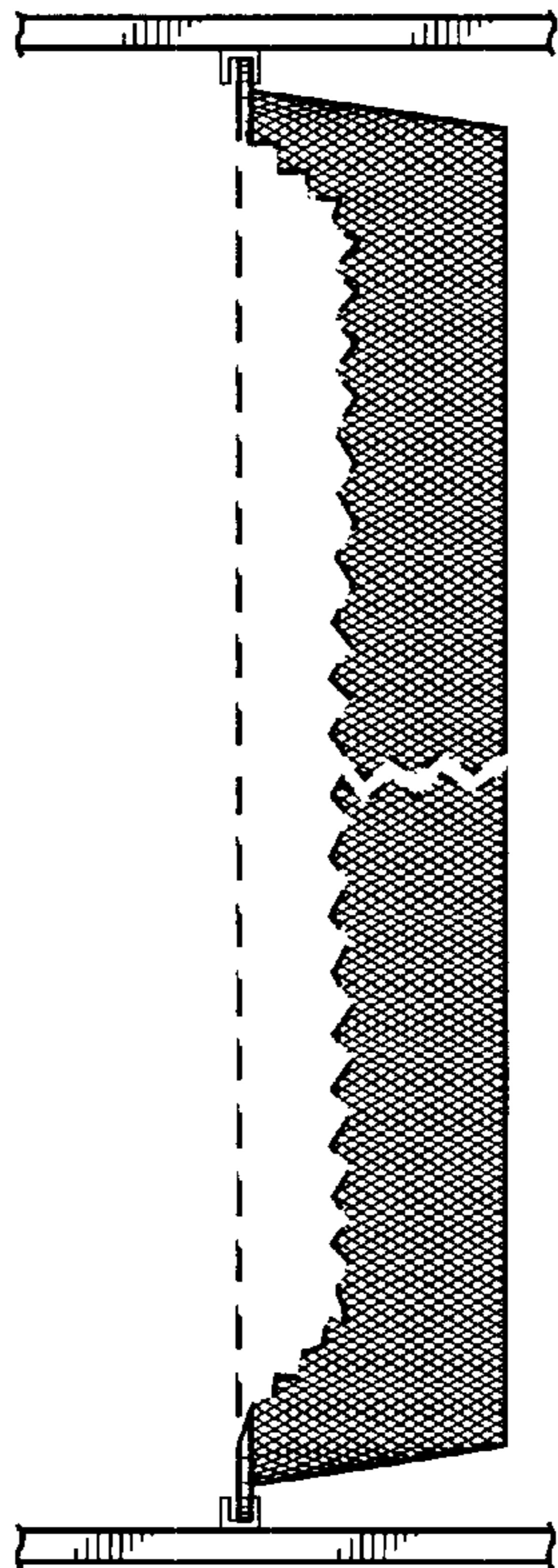

FIG. 4

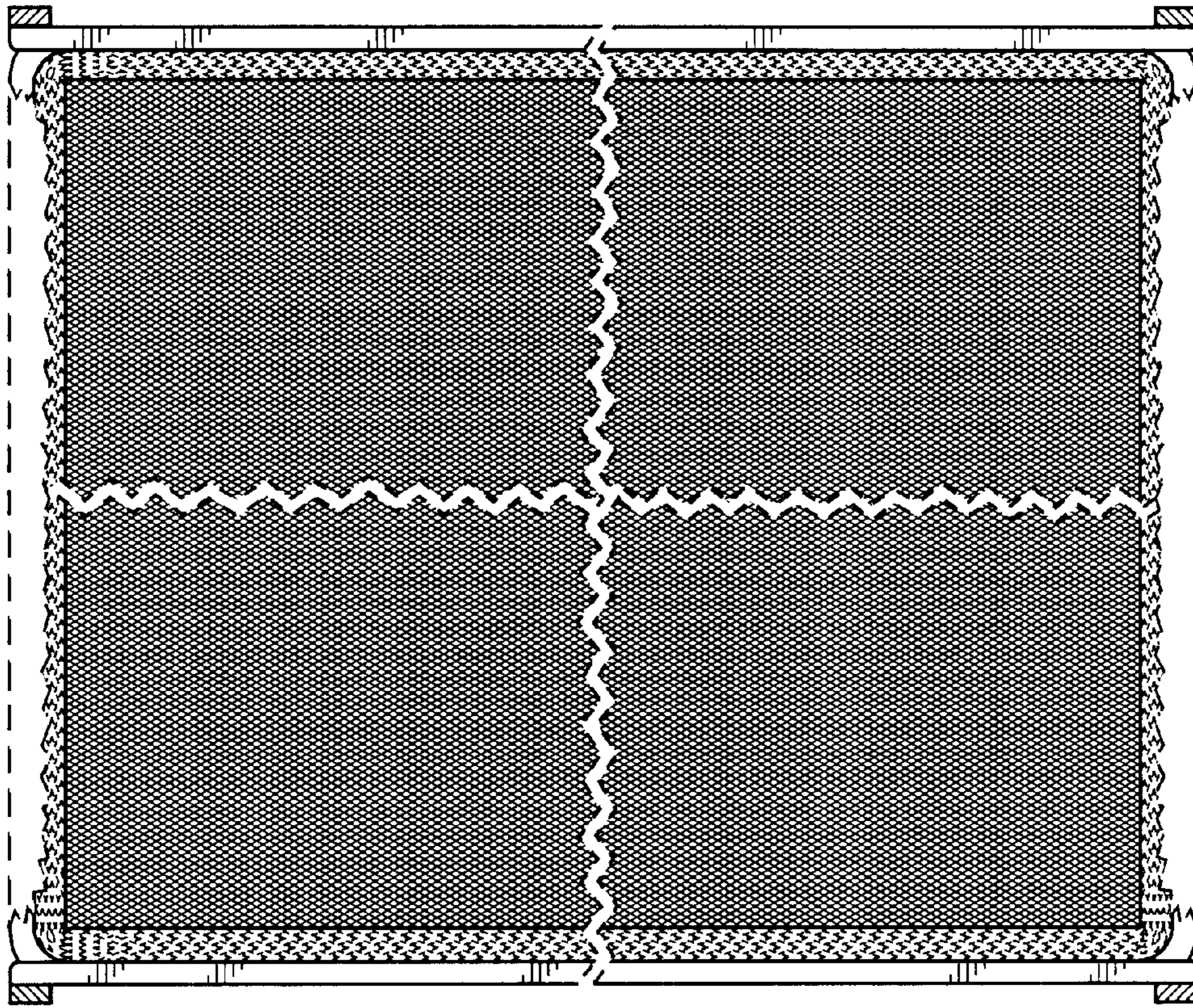

FIG. 7

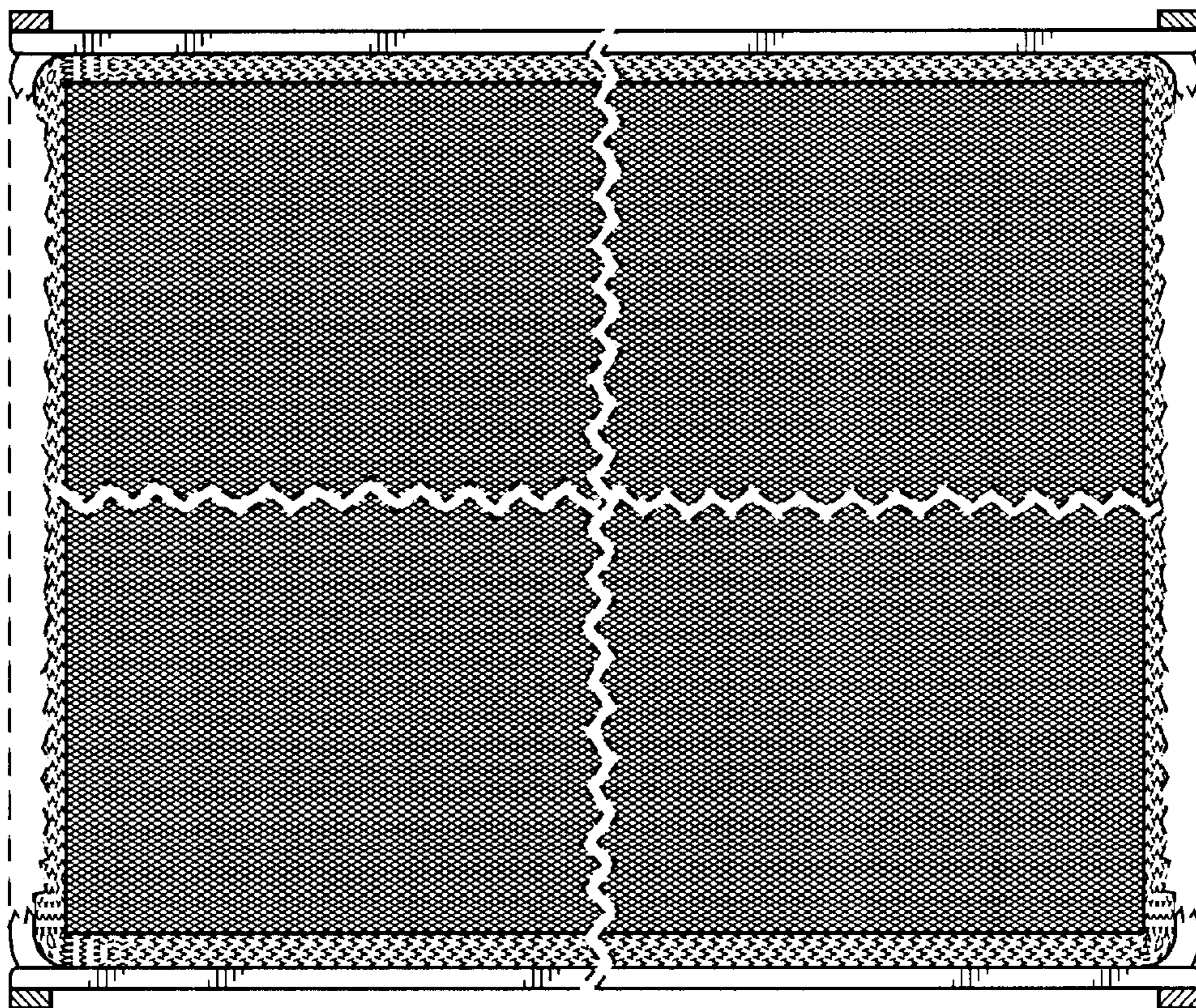

FIG. 6

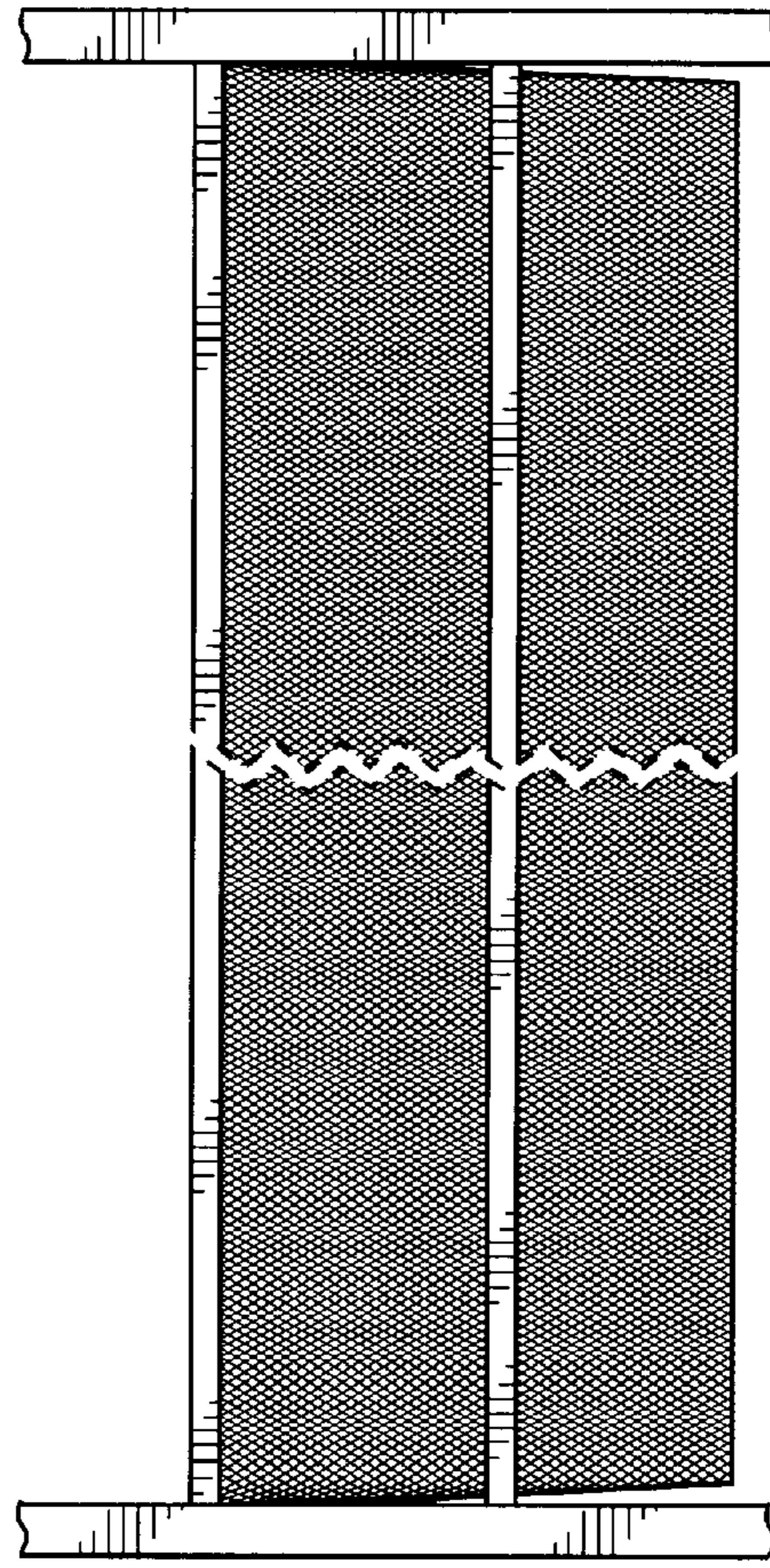

FIG. 9

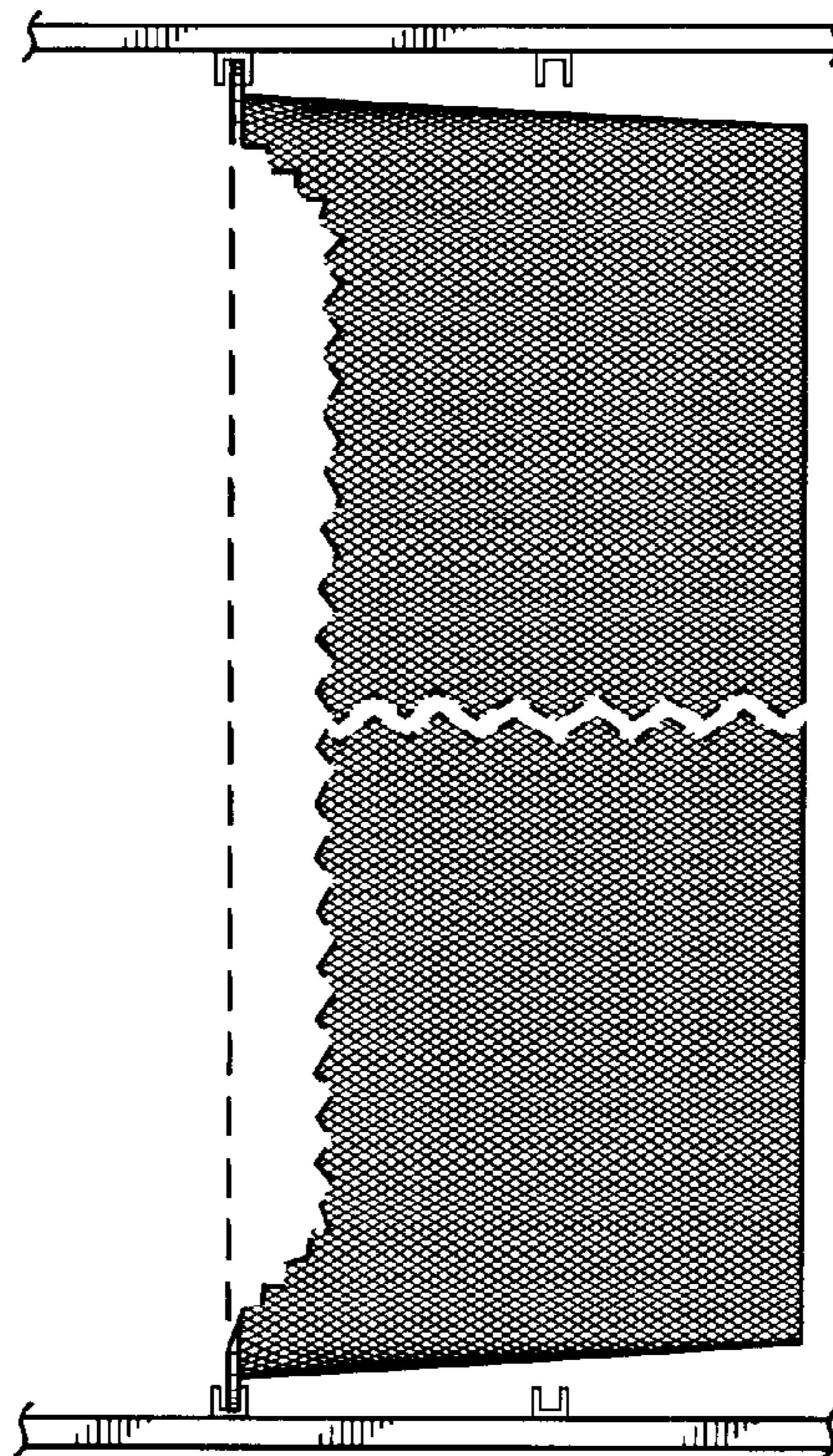

FIG. 8

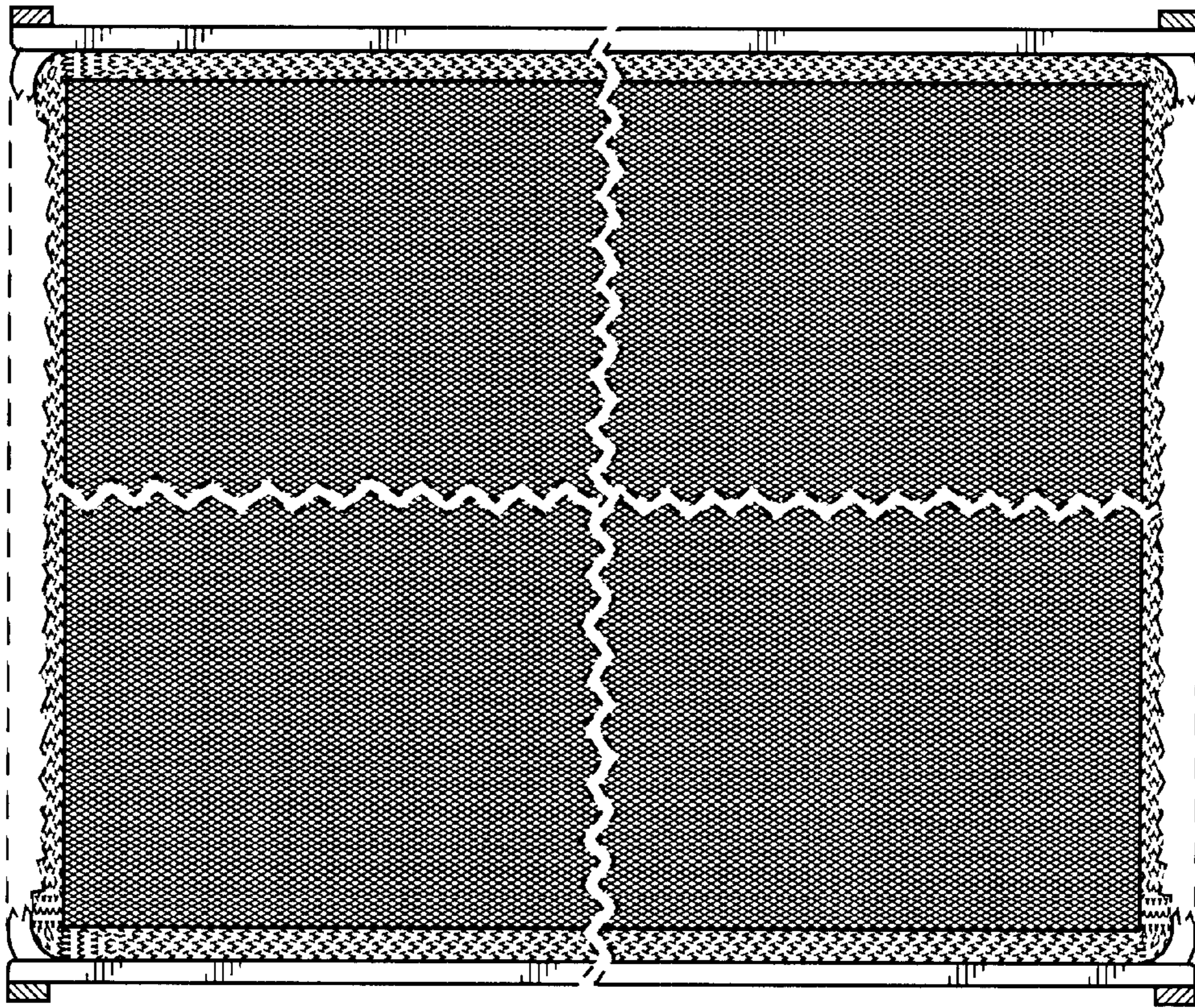

FIG.11

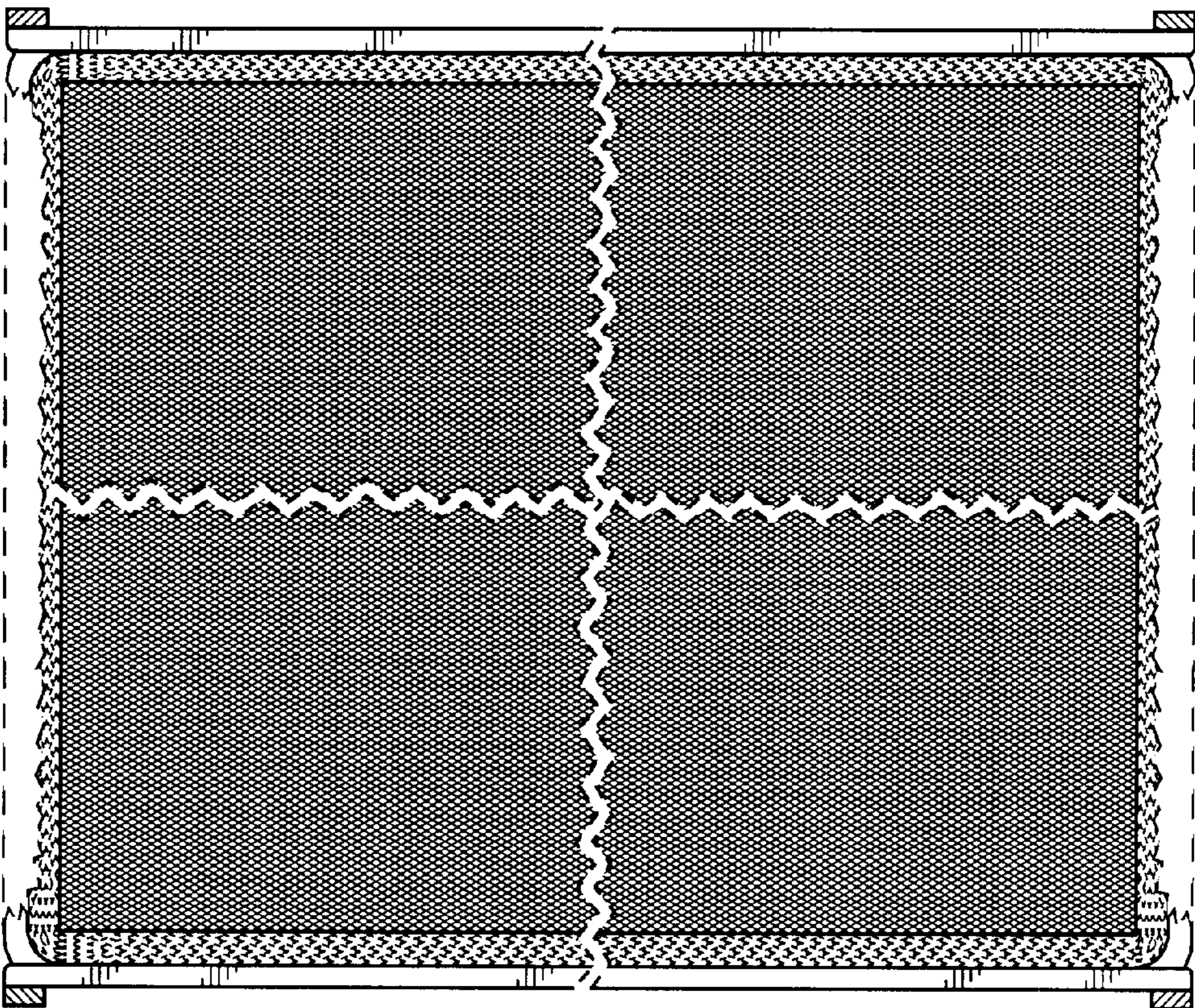

FIG.10

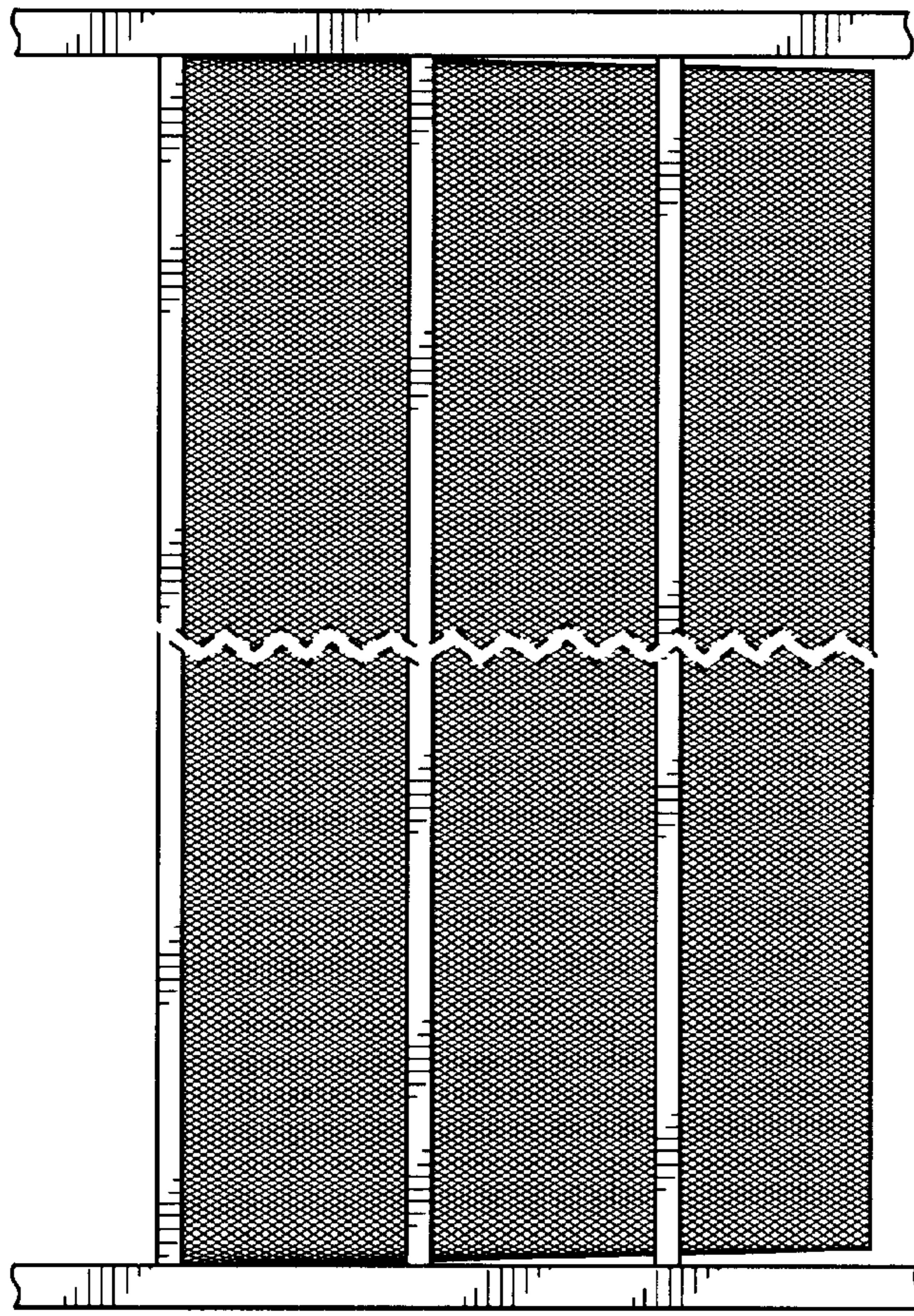

FIG. 13

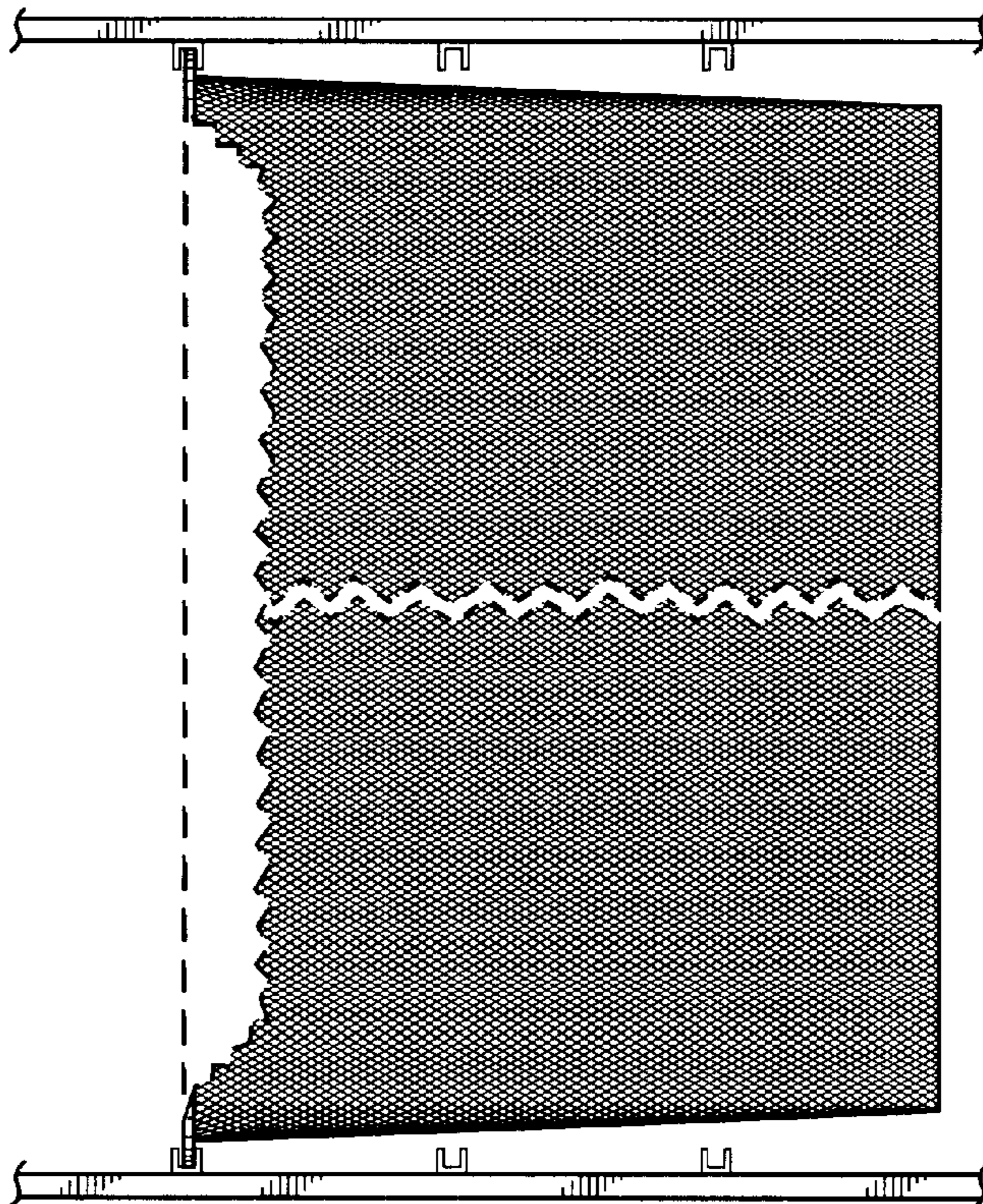

FIG. 12

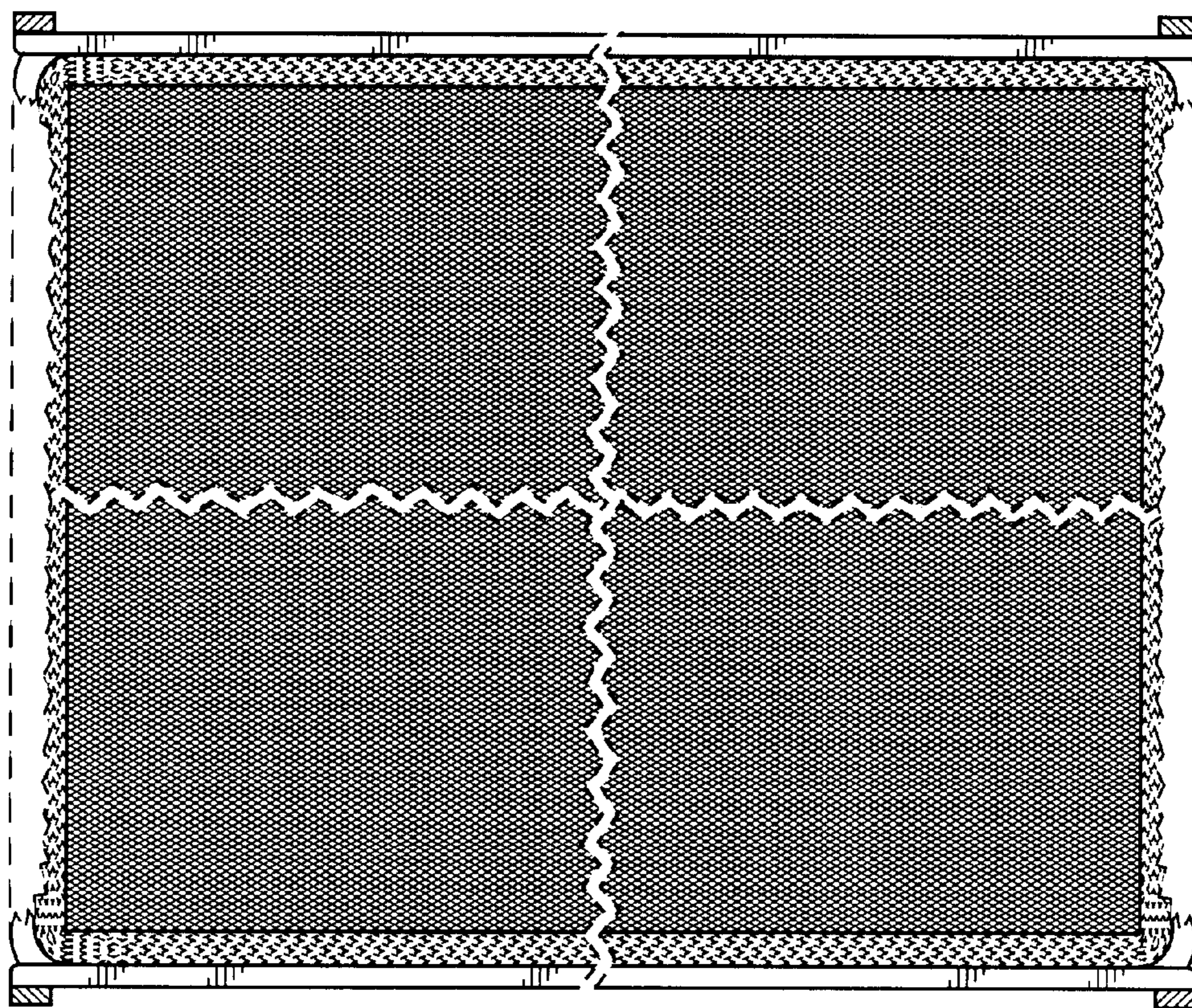

FIG.15

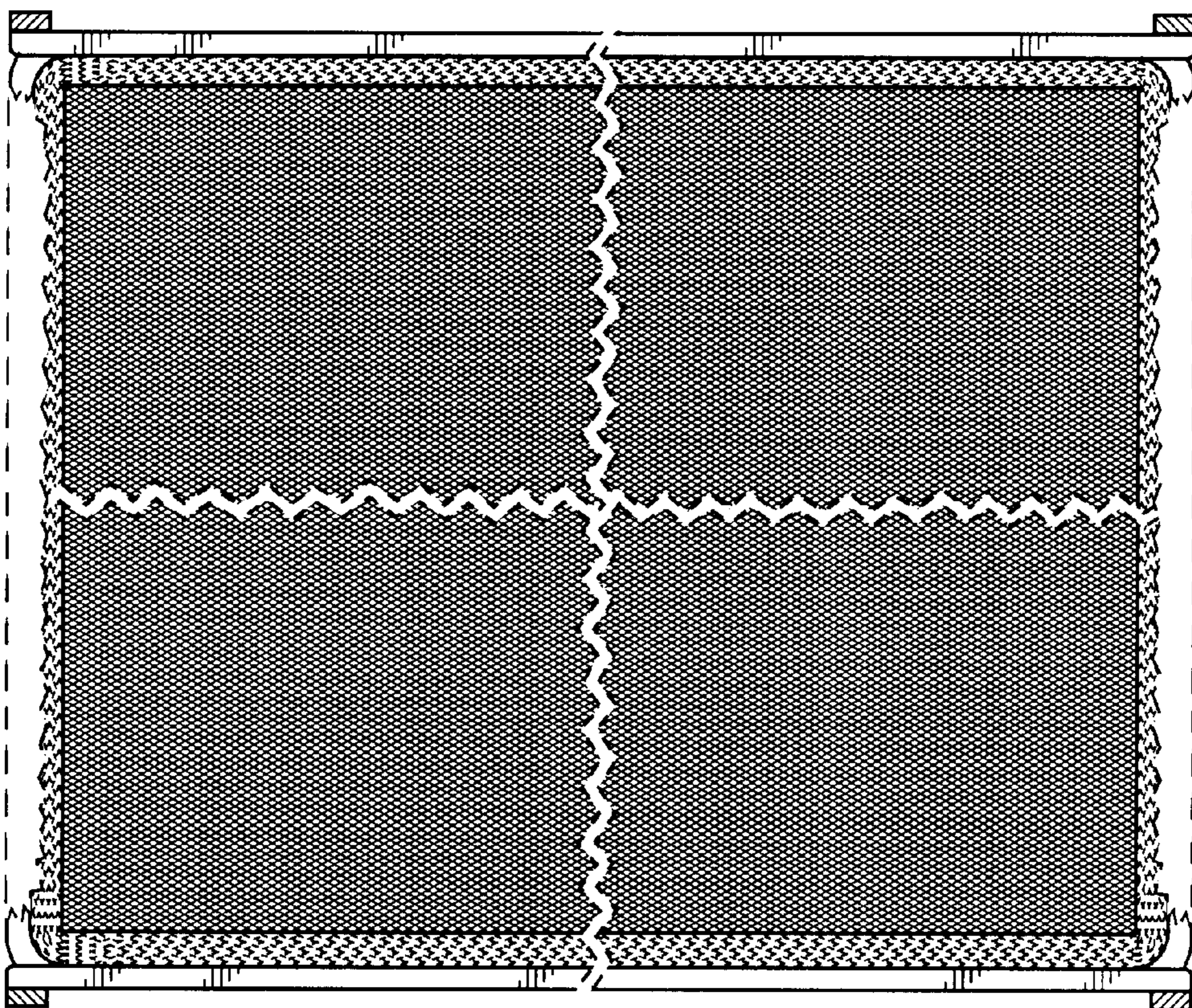

FIG.14

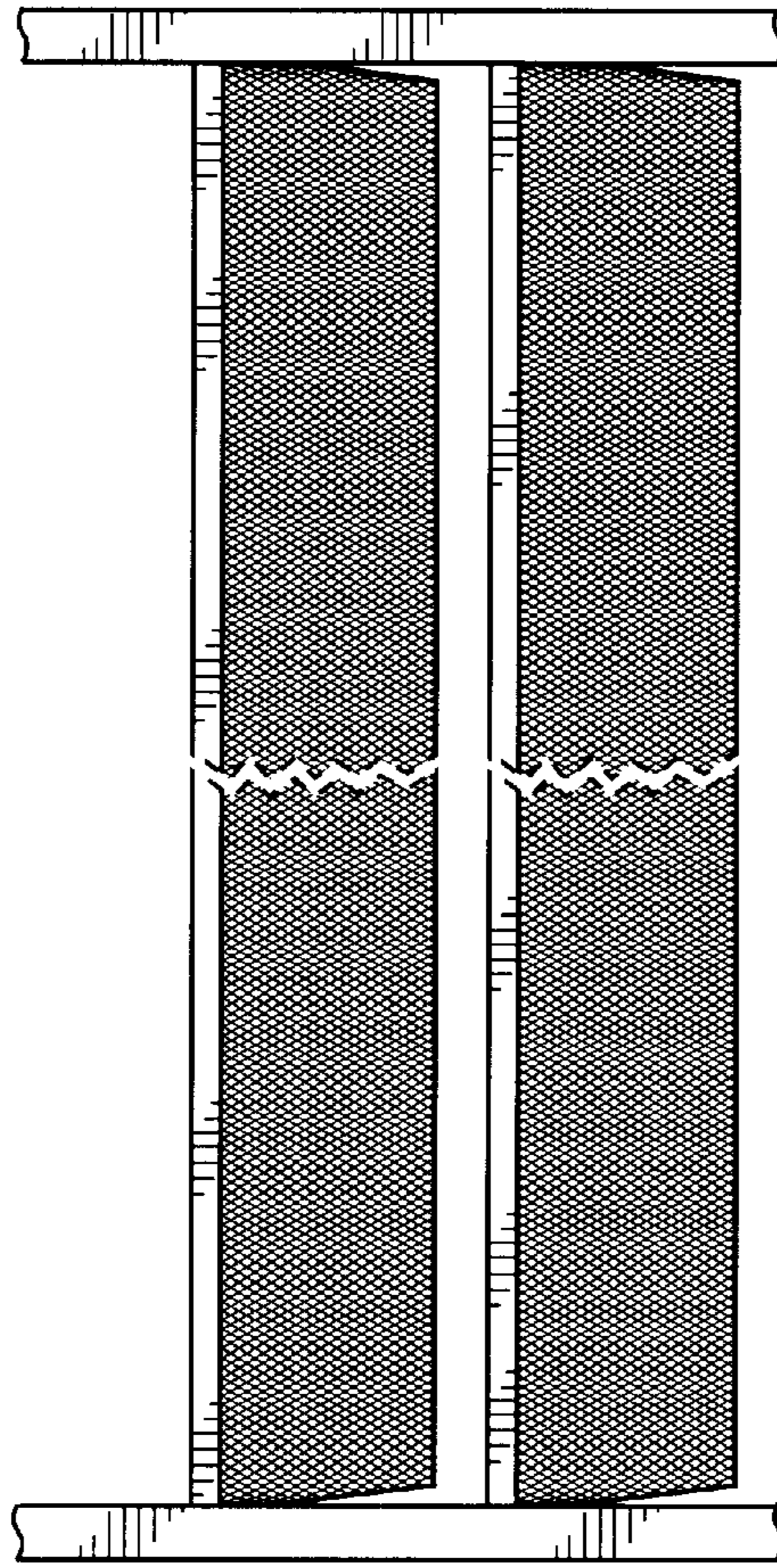

FIG.17

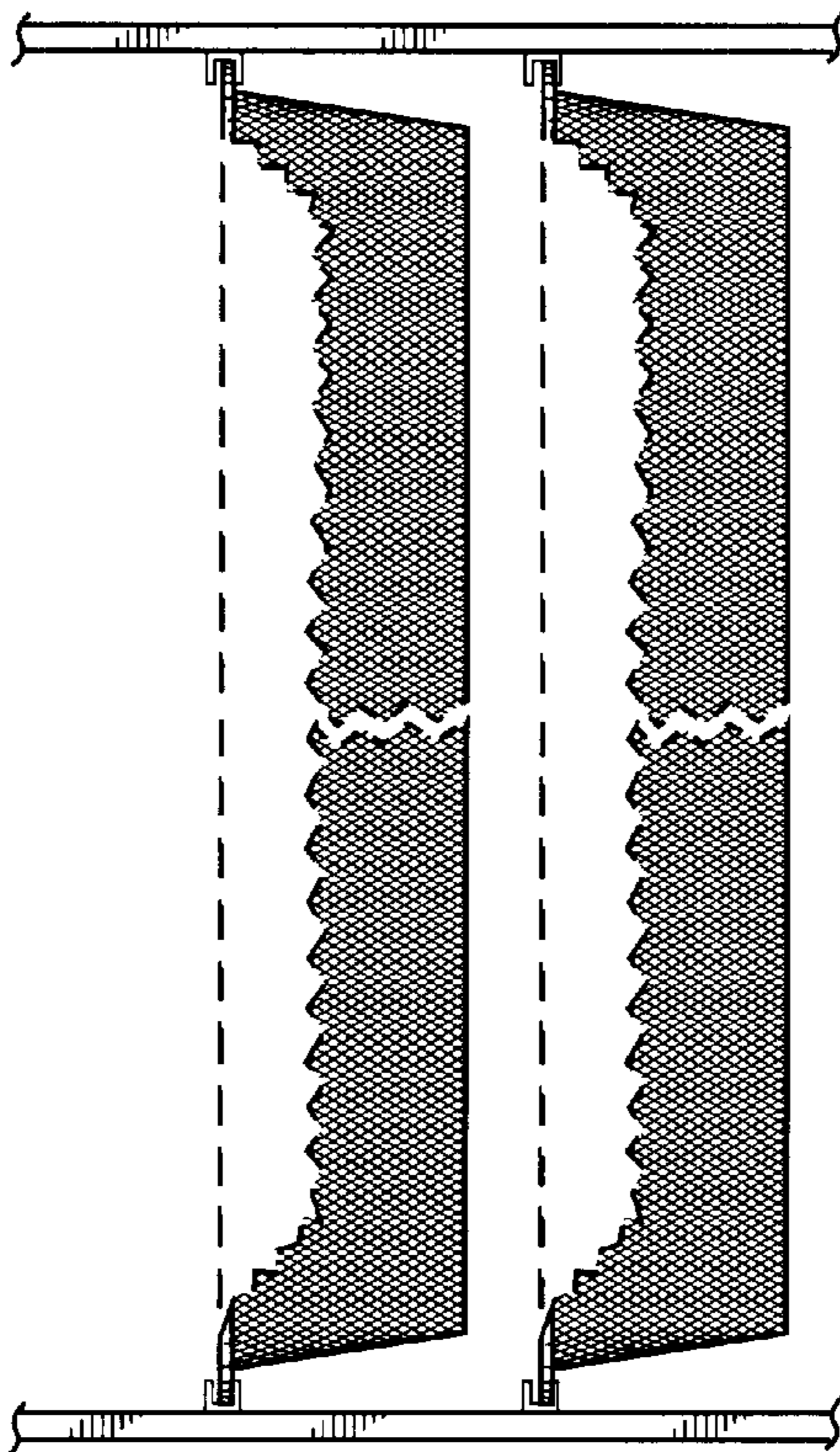

FIG.16

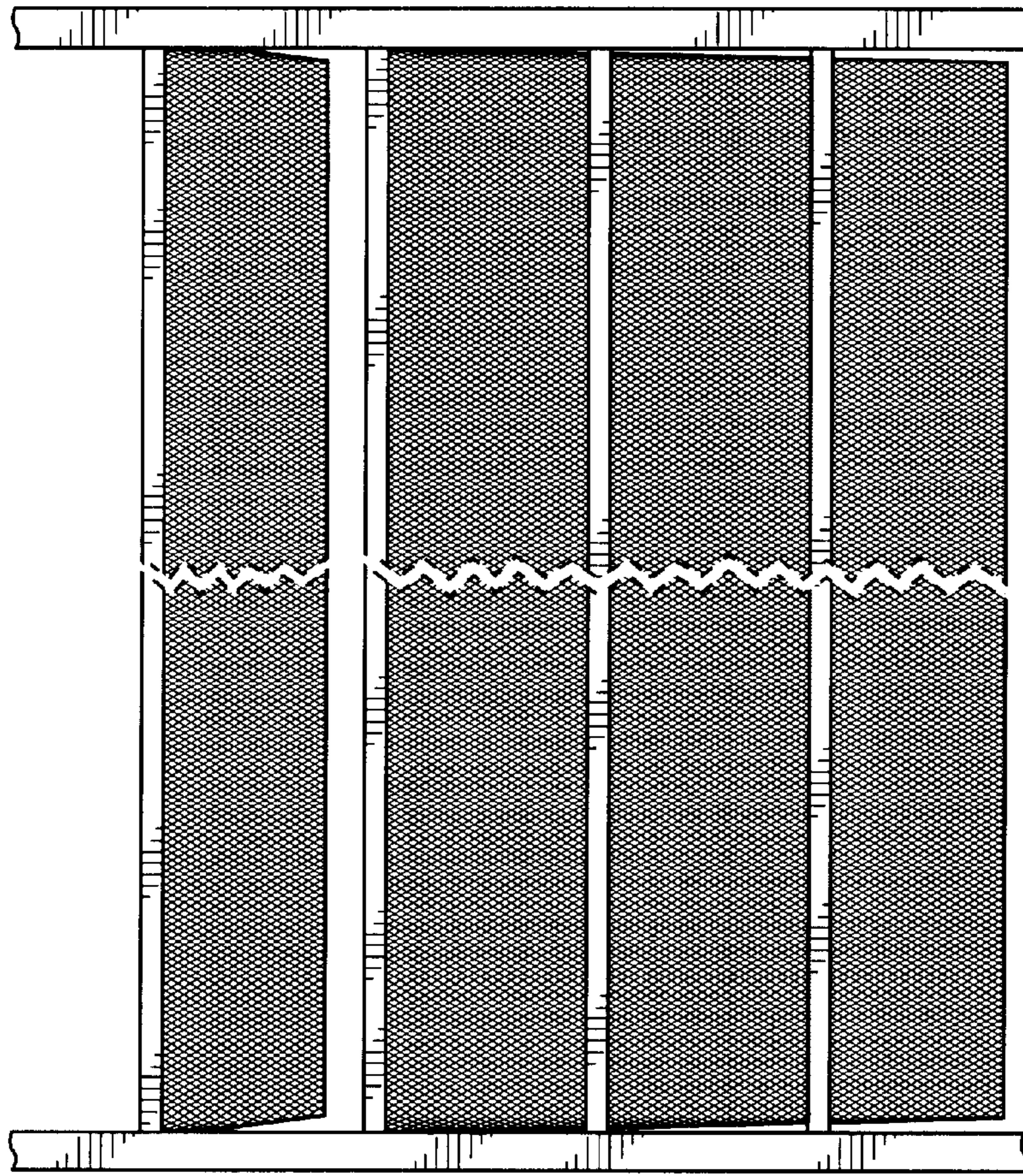

FIG.19

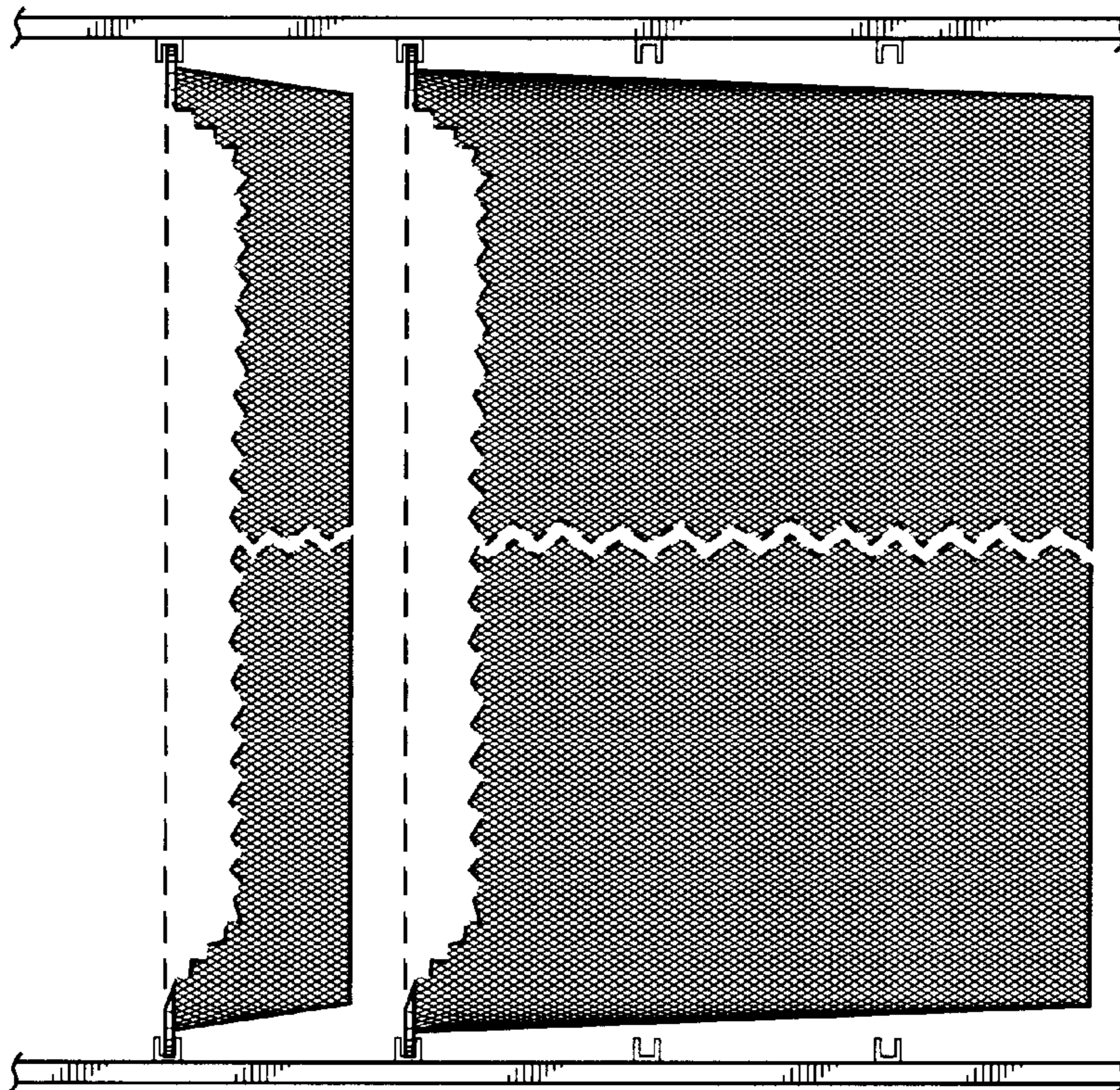

FIG.18

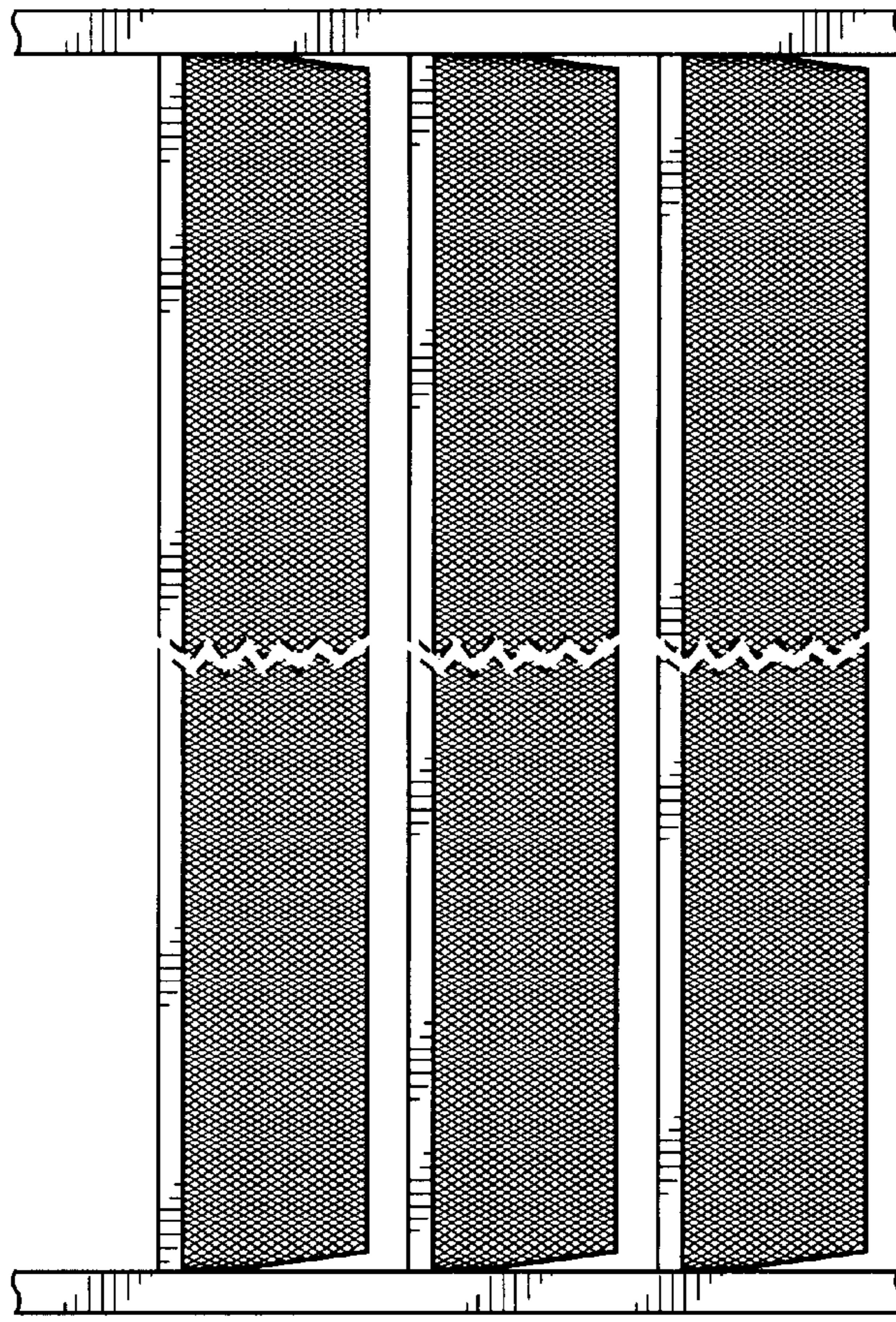

FIG. 21

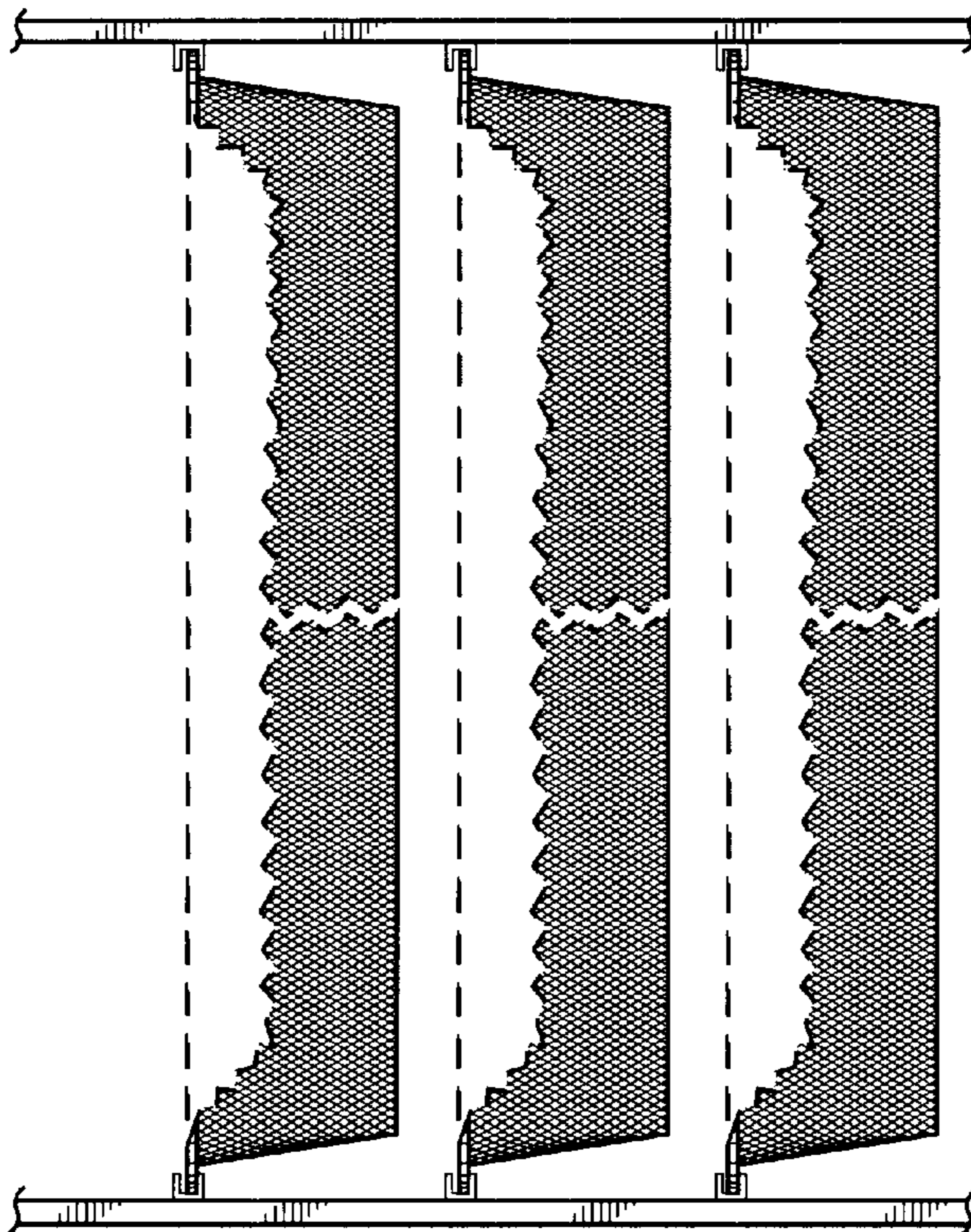

FIG. 20

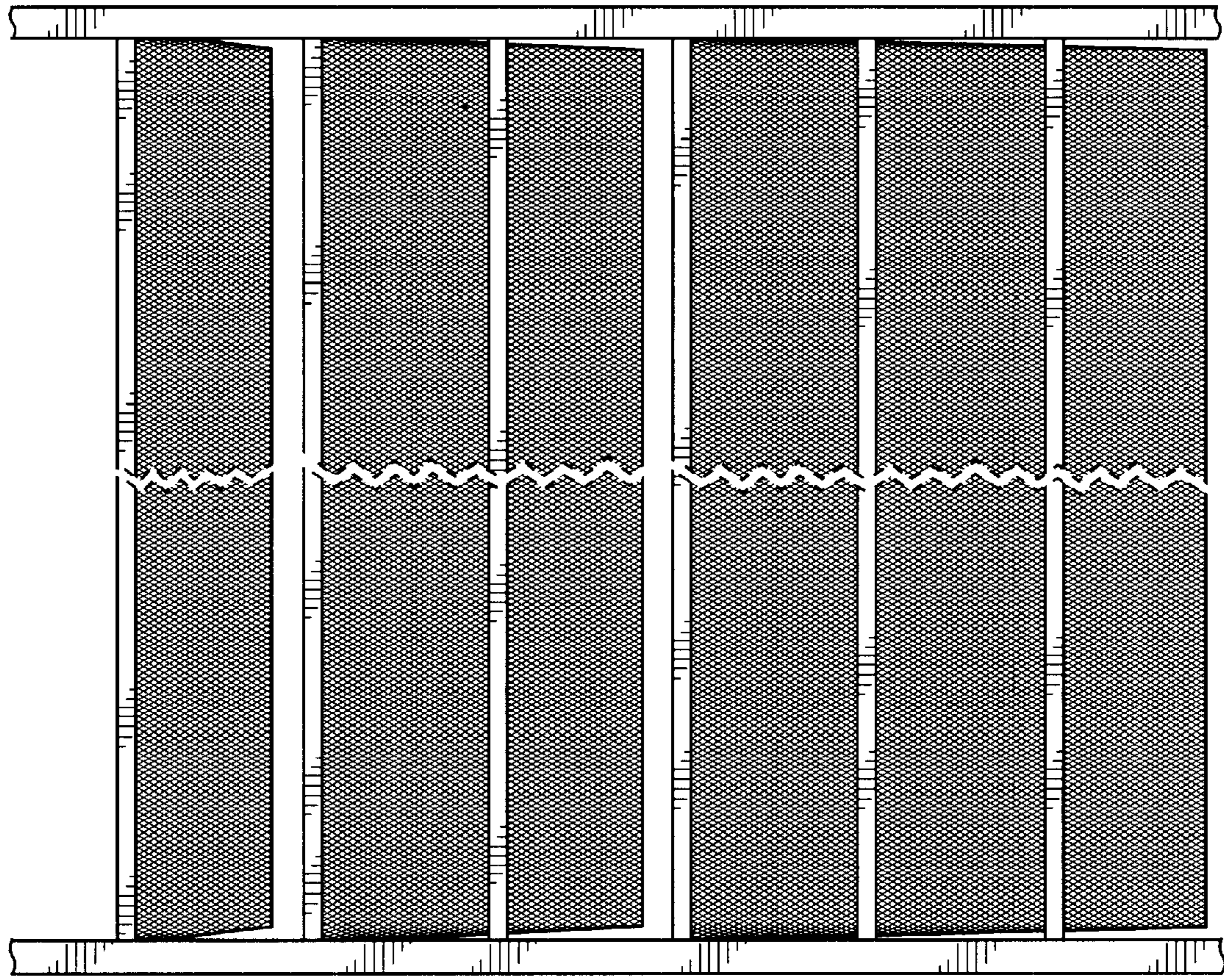

FIG. 23

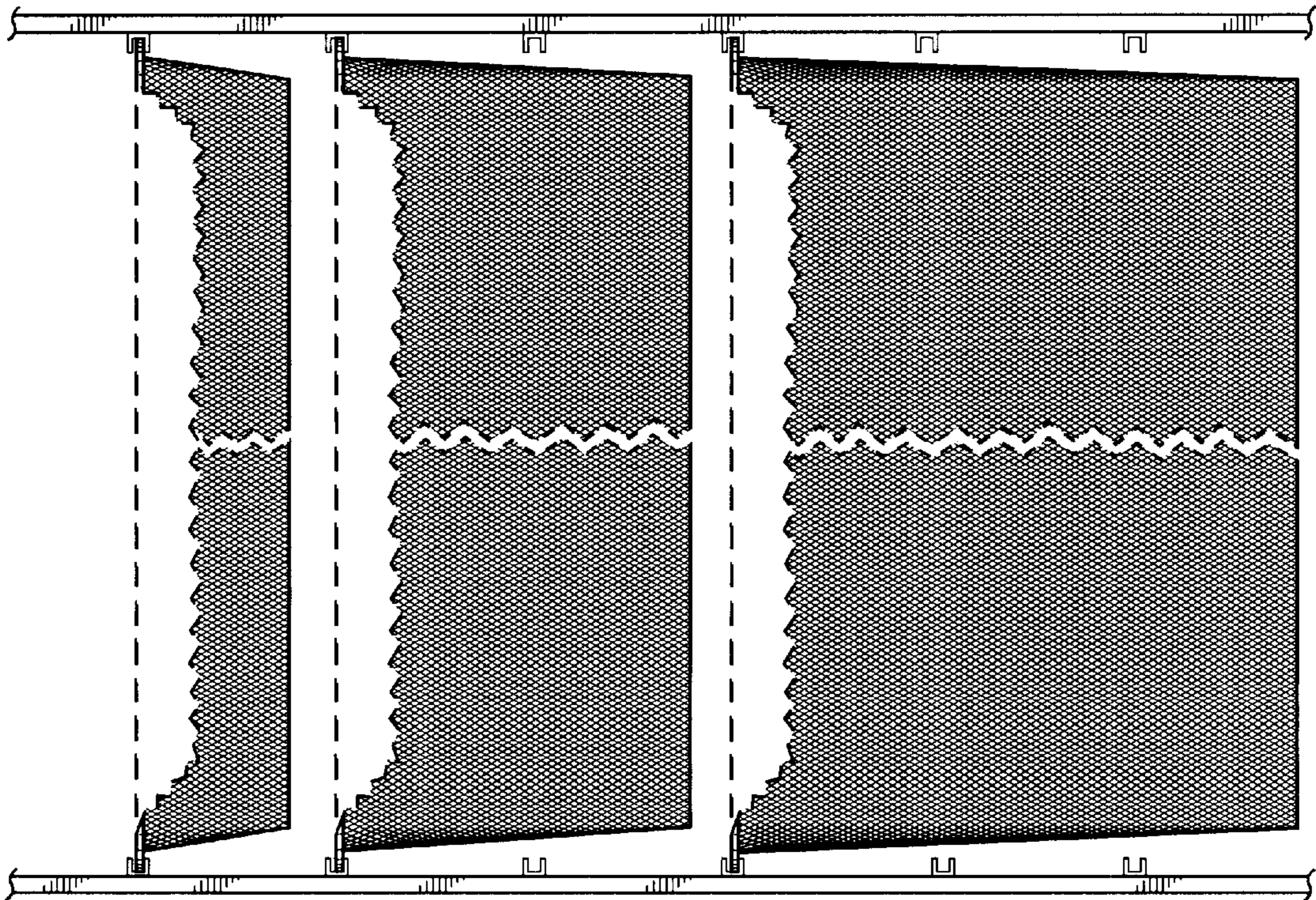

FIG. 22

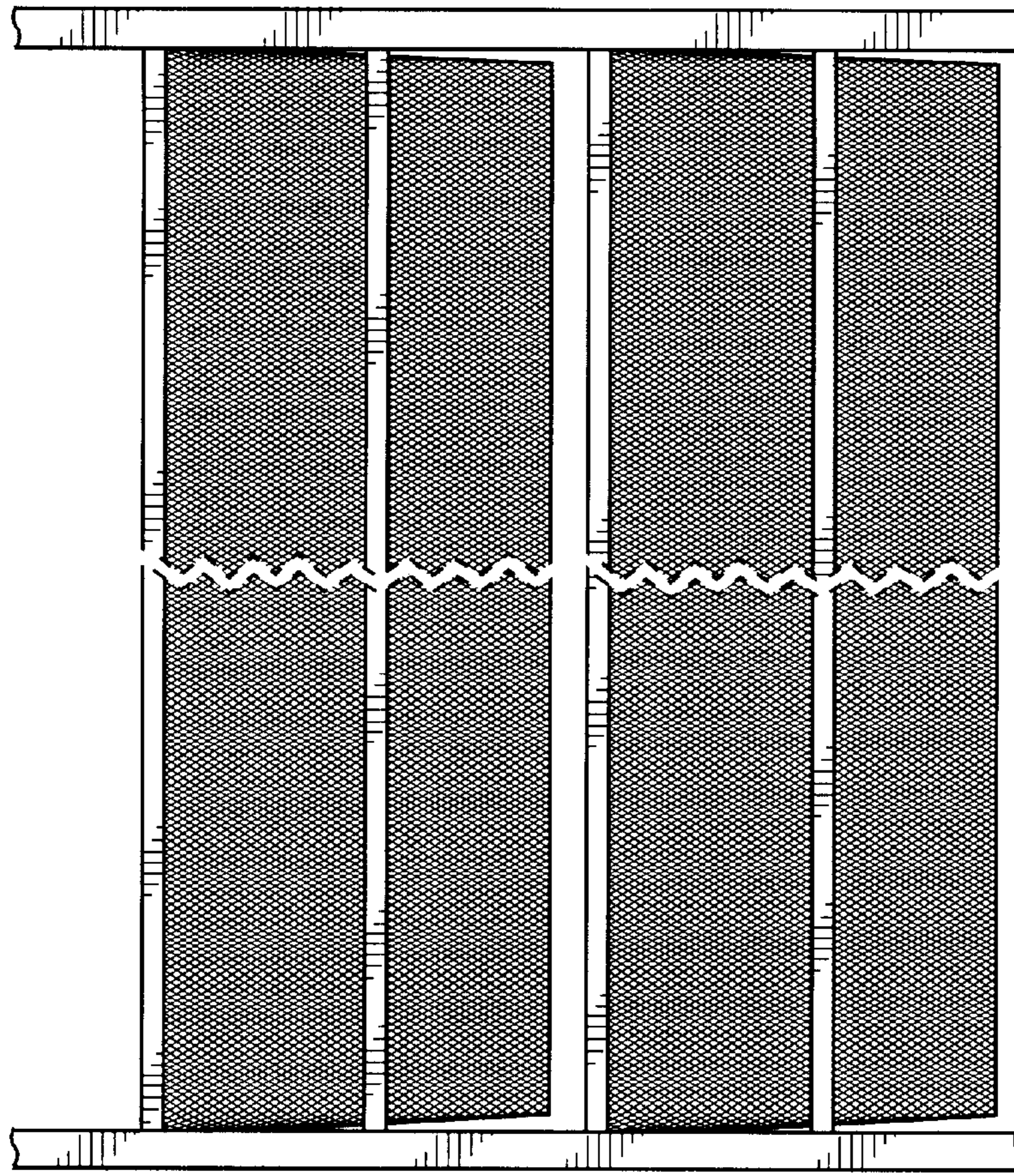

FIG. 25

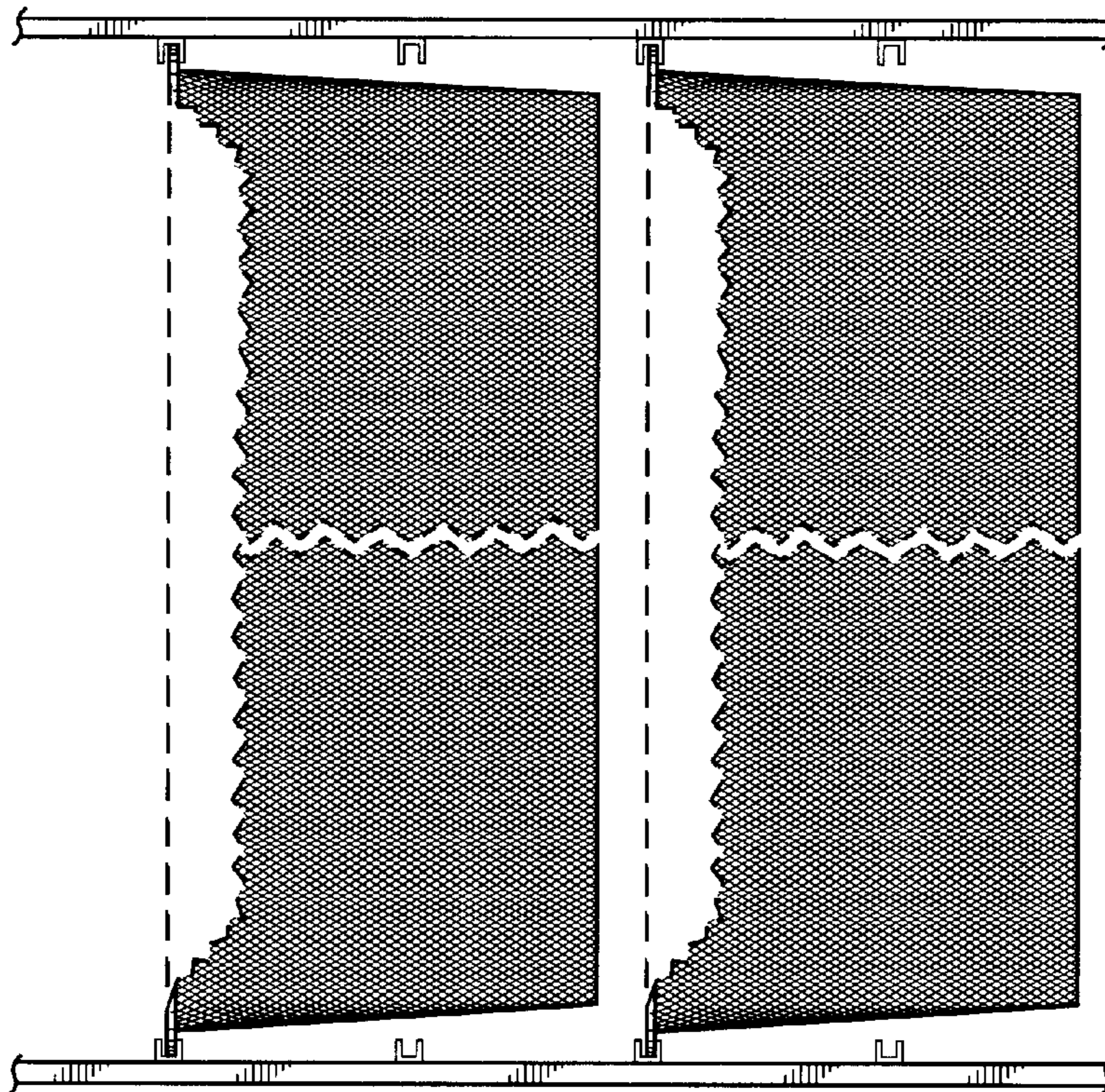

FIG. 24

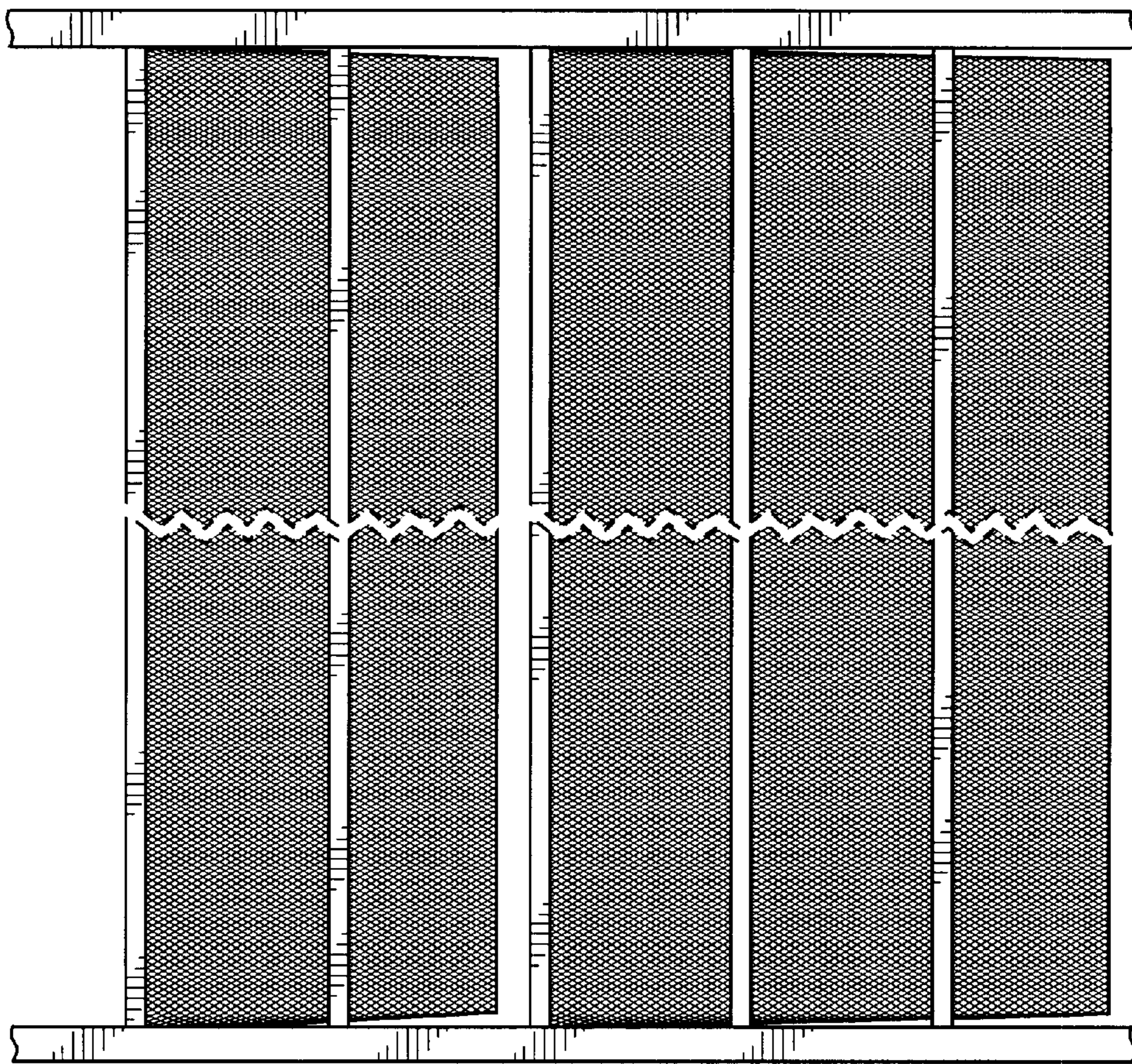

FIG. 27

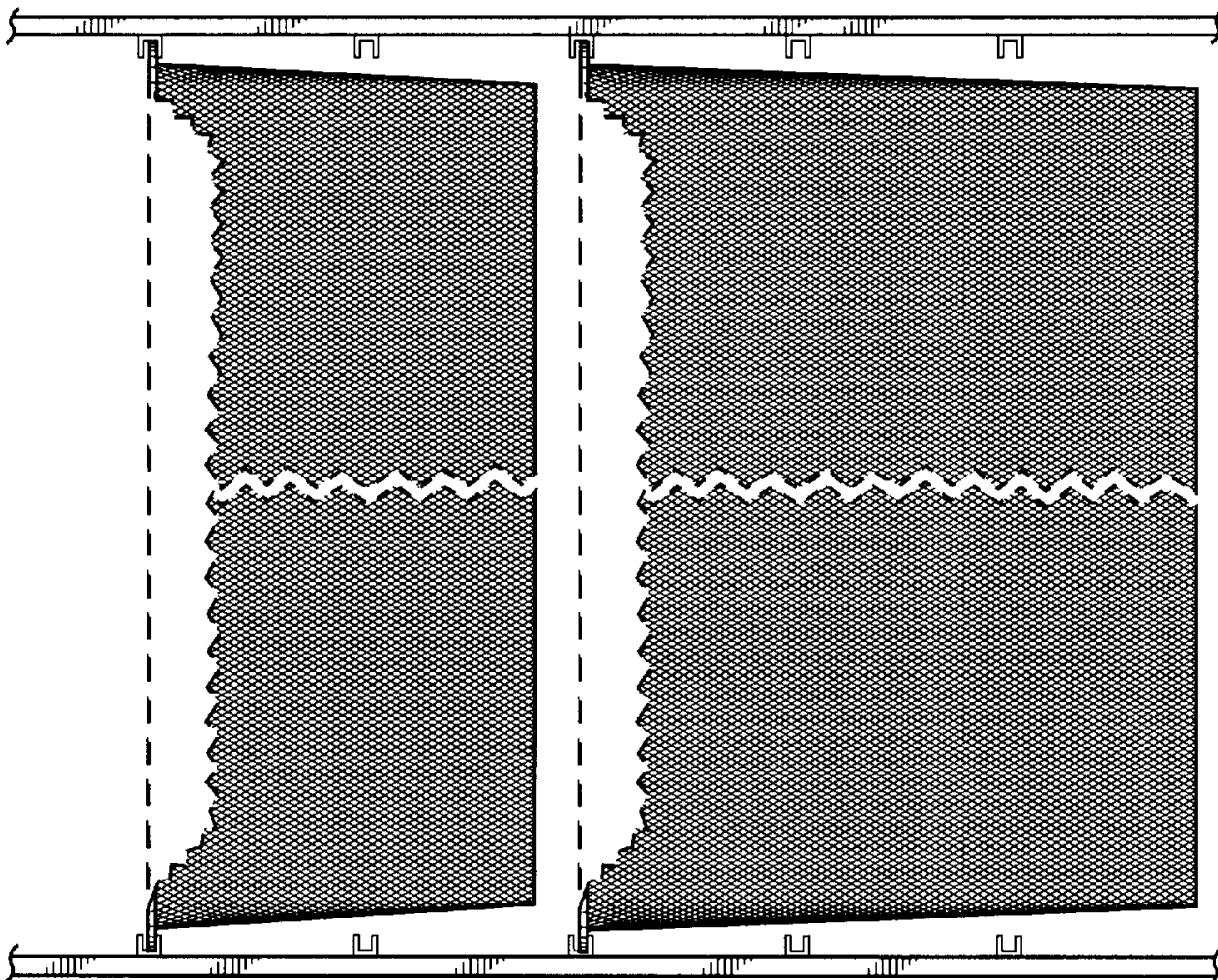

FIG. 26

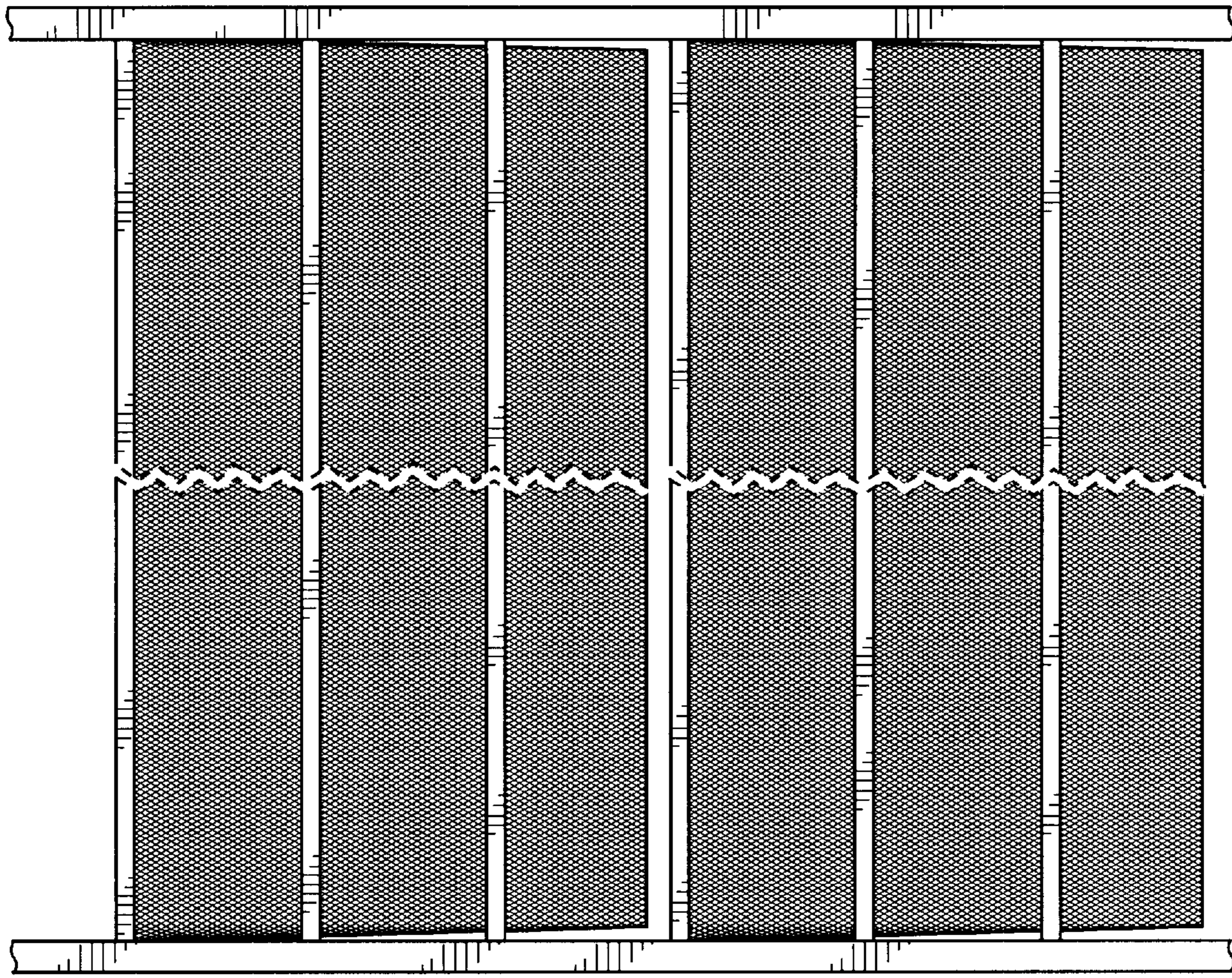

FIG. 29

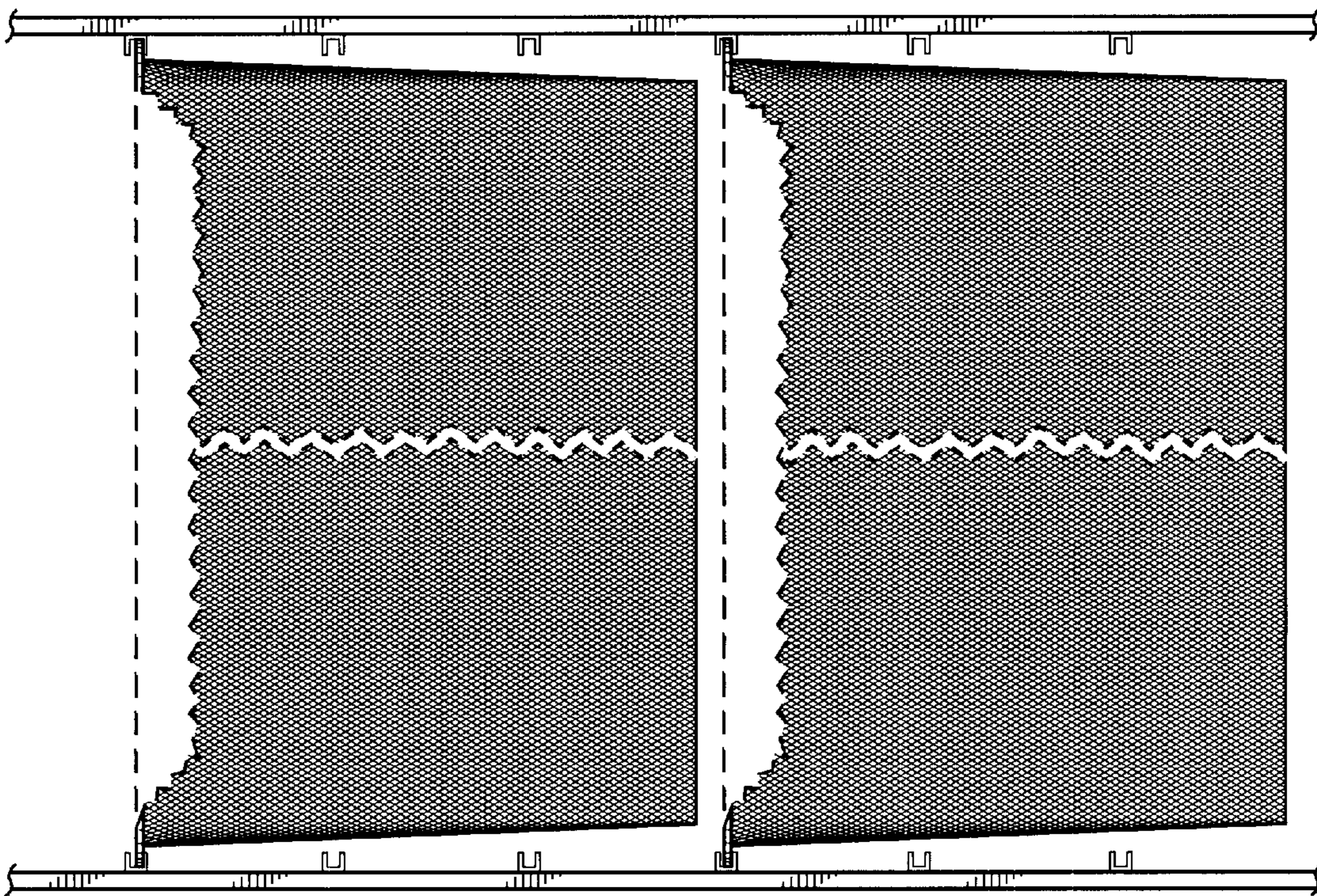

FIG. 28

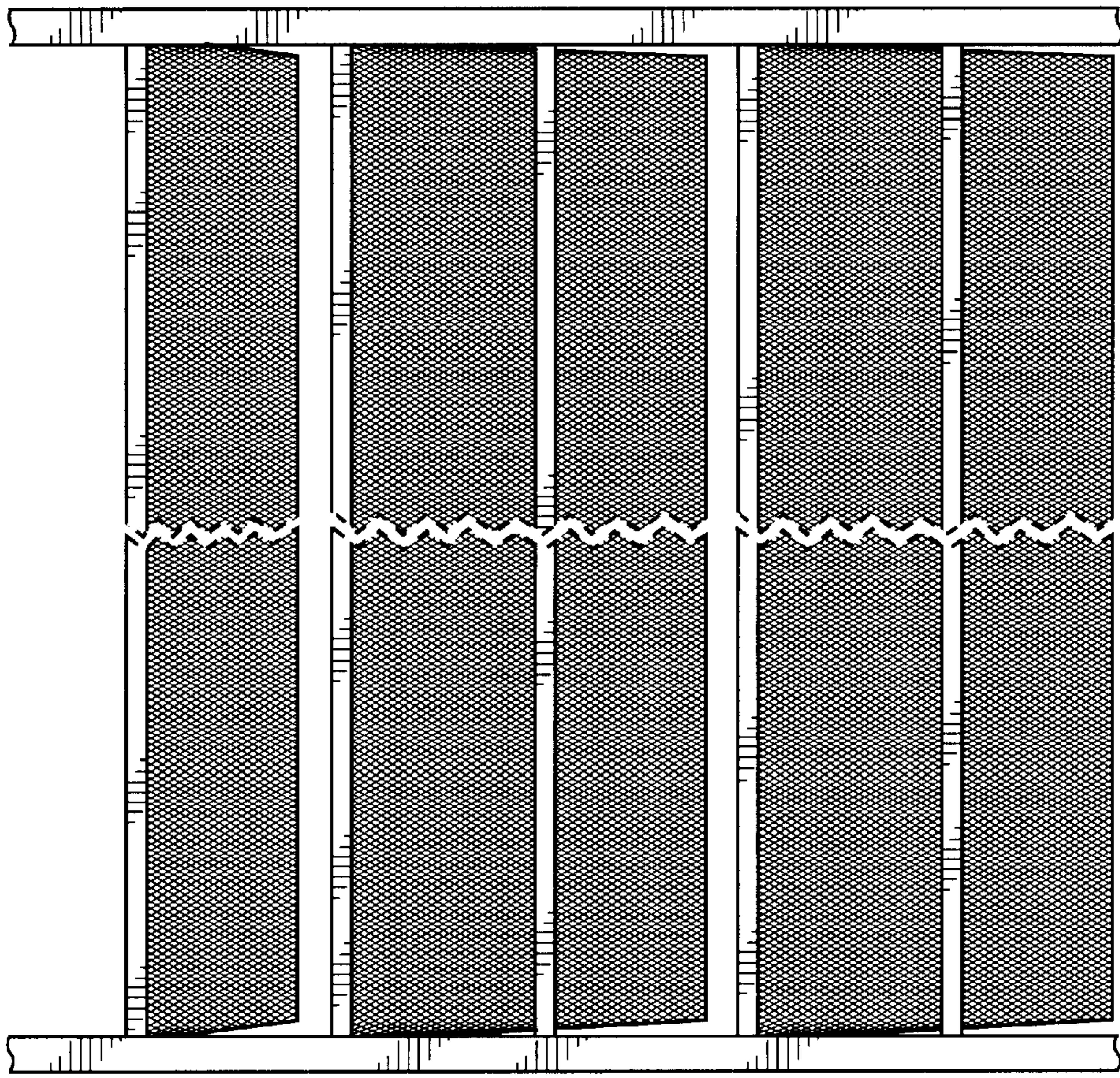

FIG. 31

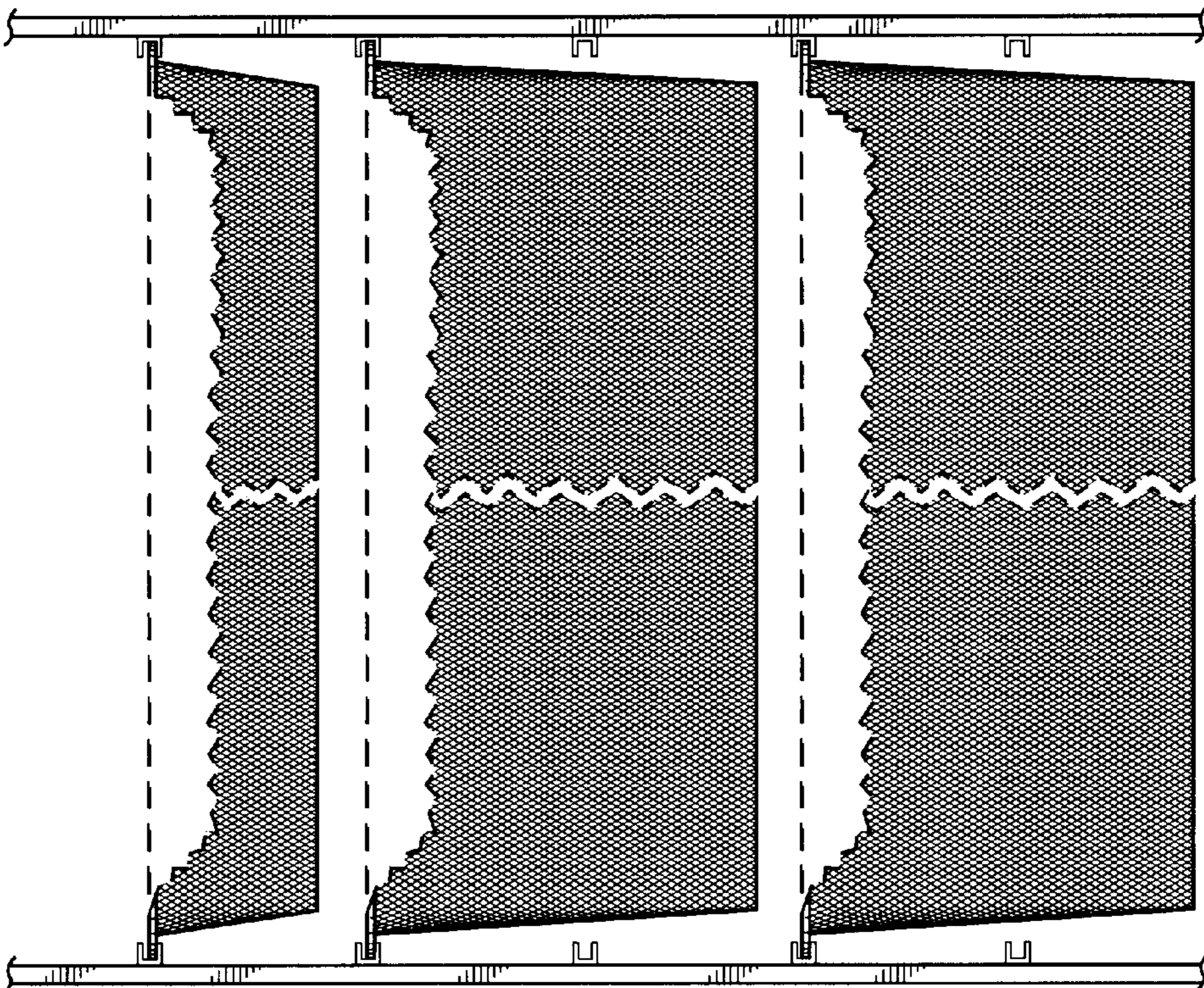

FIG. 30

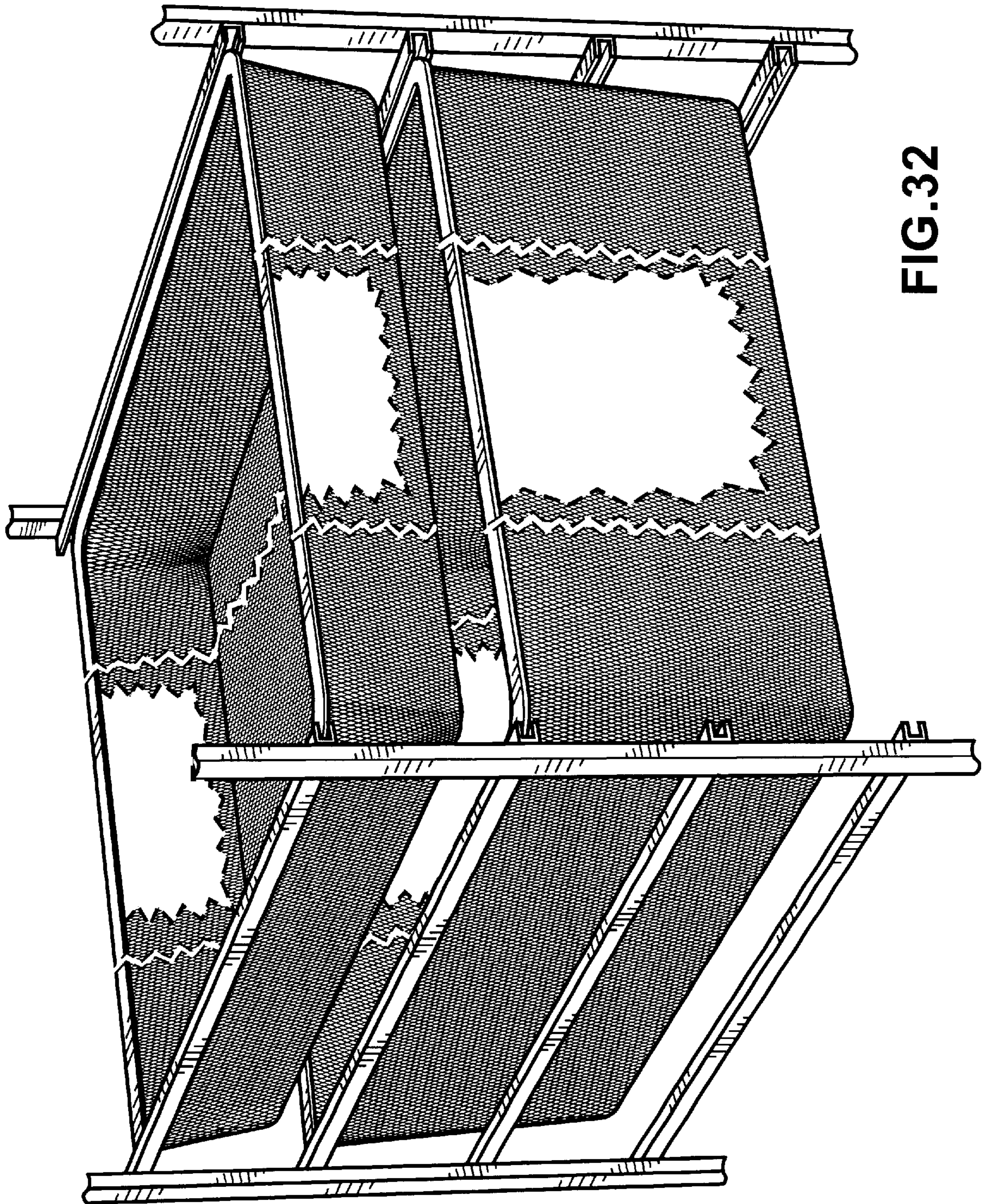

FIG.32

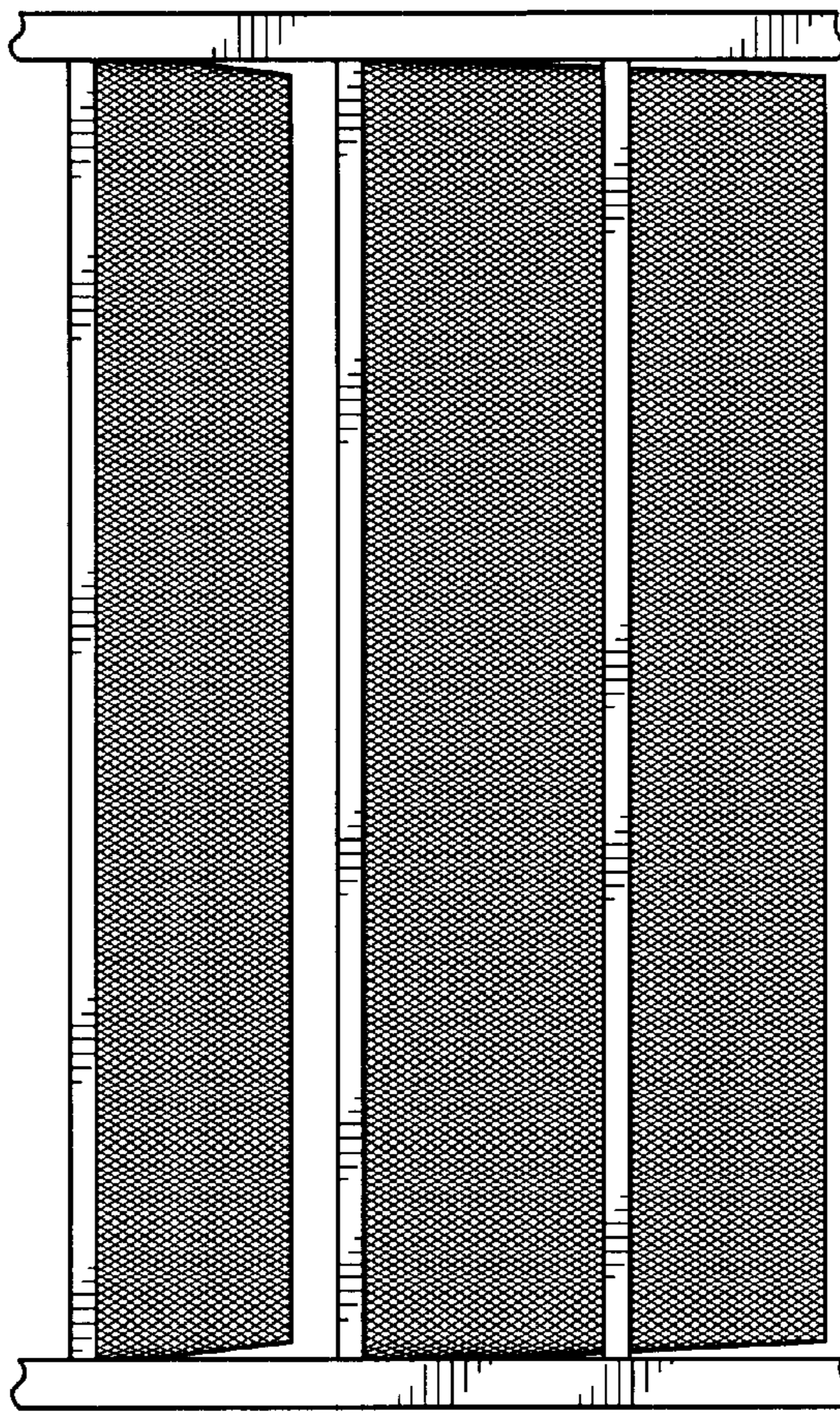

FIG. 34

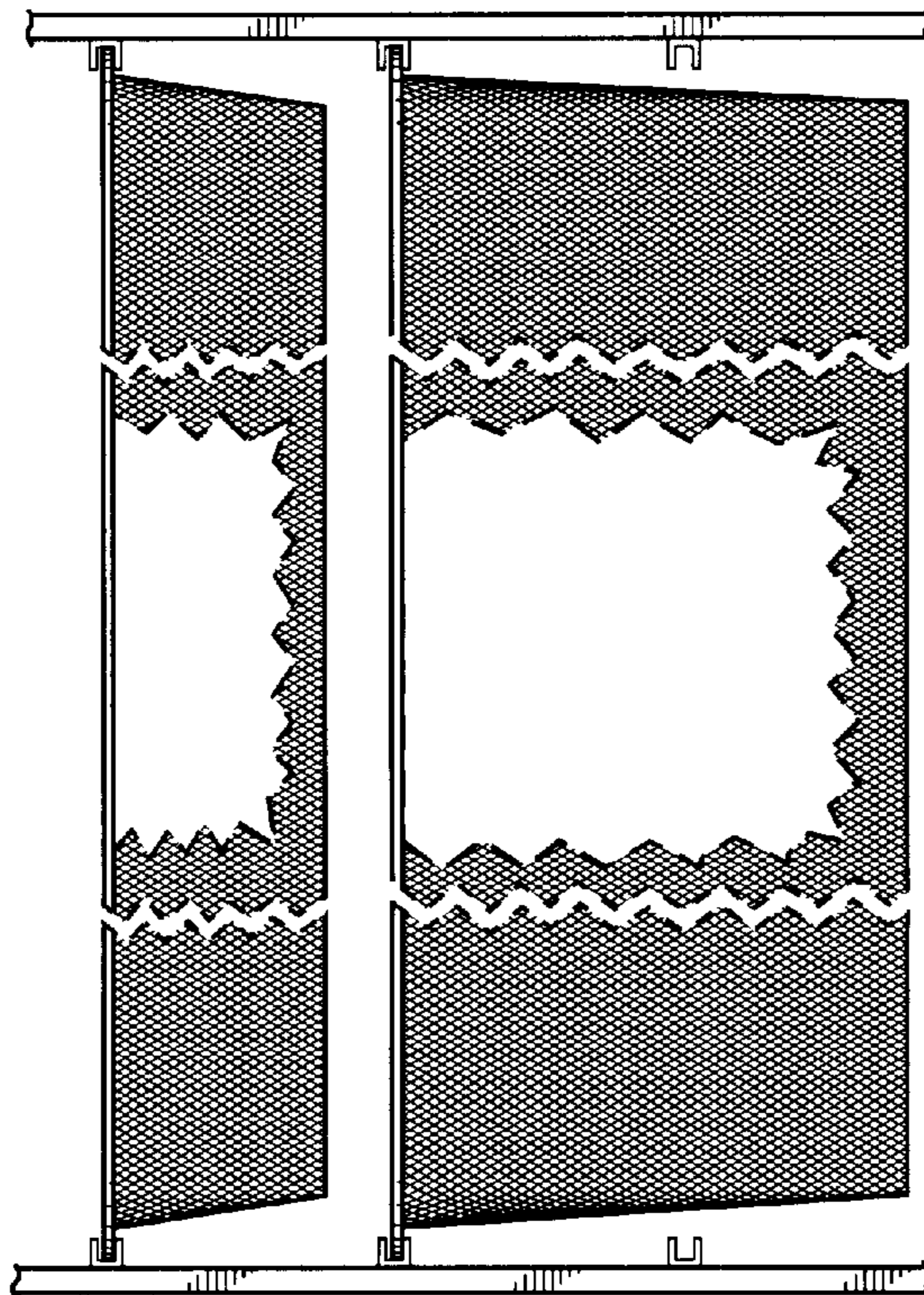

FIG. 33

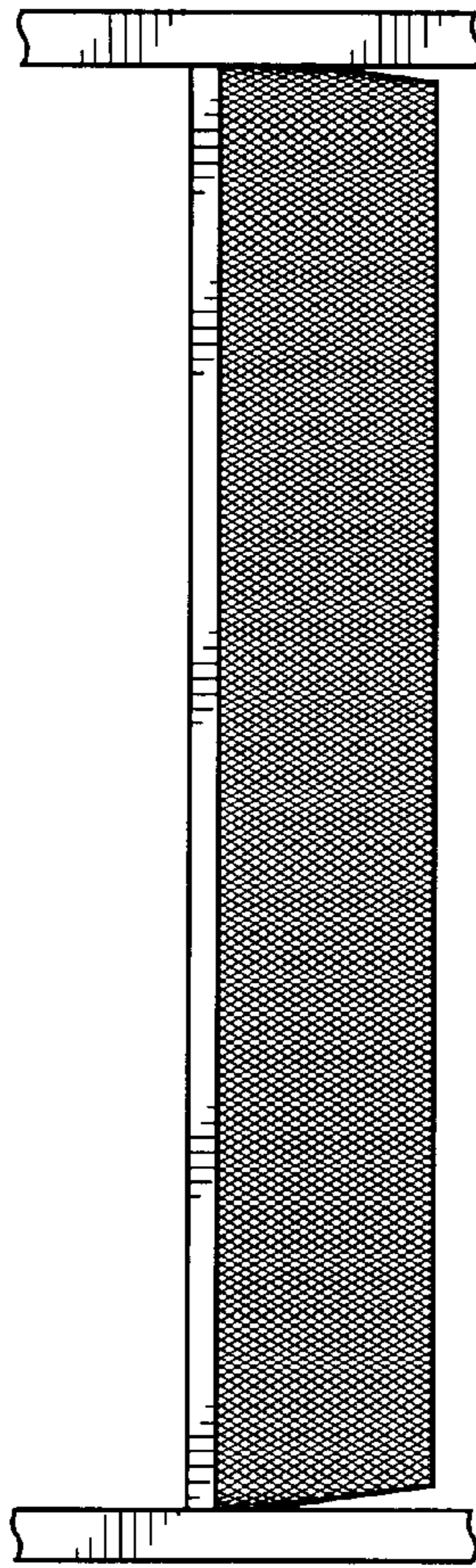

FIG. 36

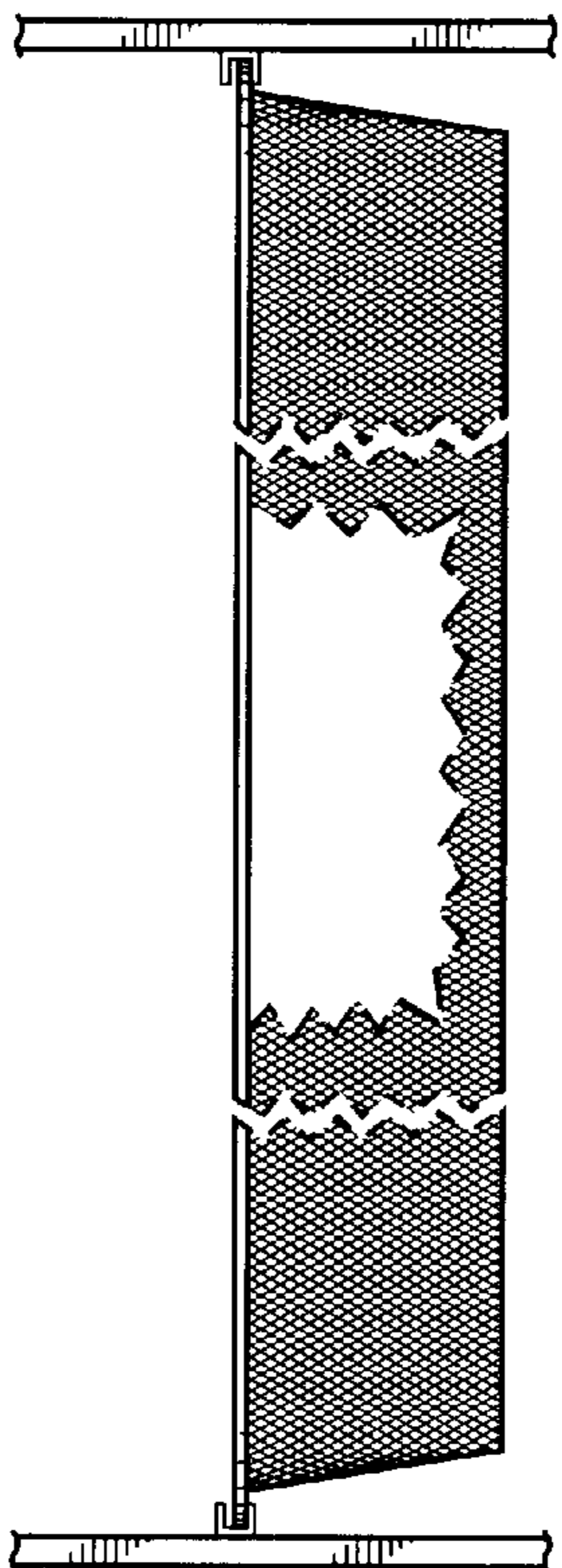

FIG. 35

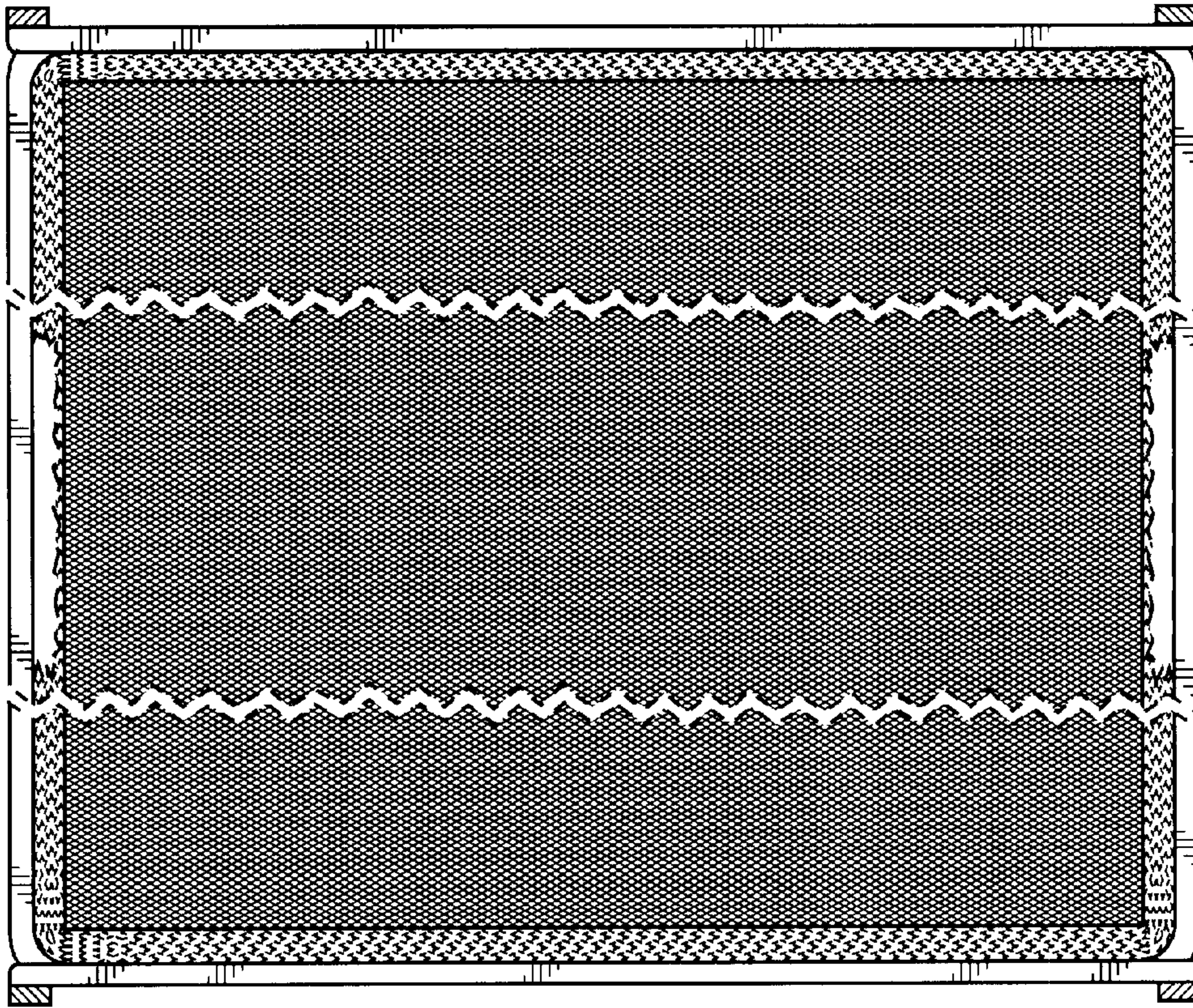

FIG. 38

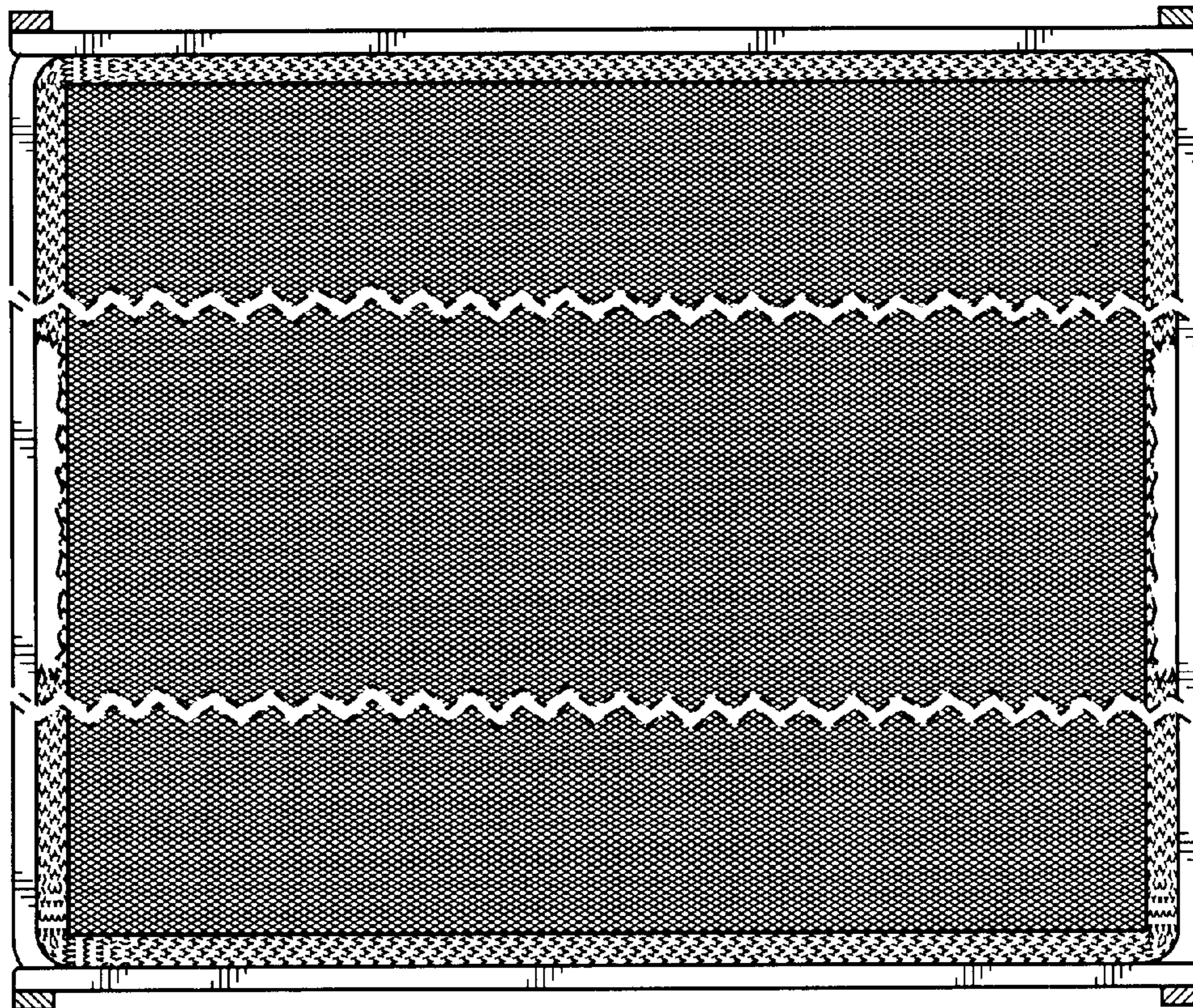

FIG. 37

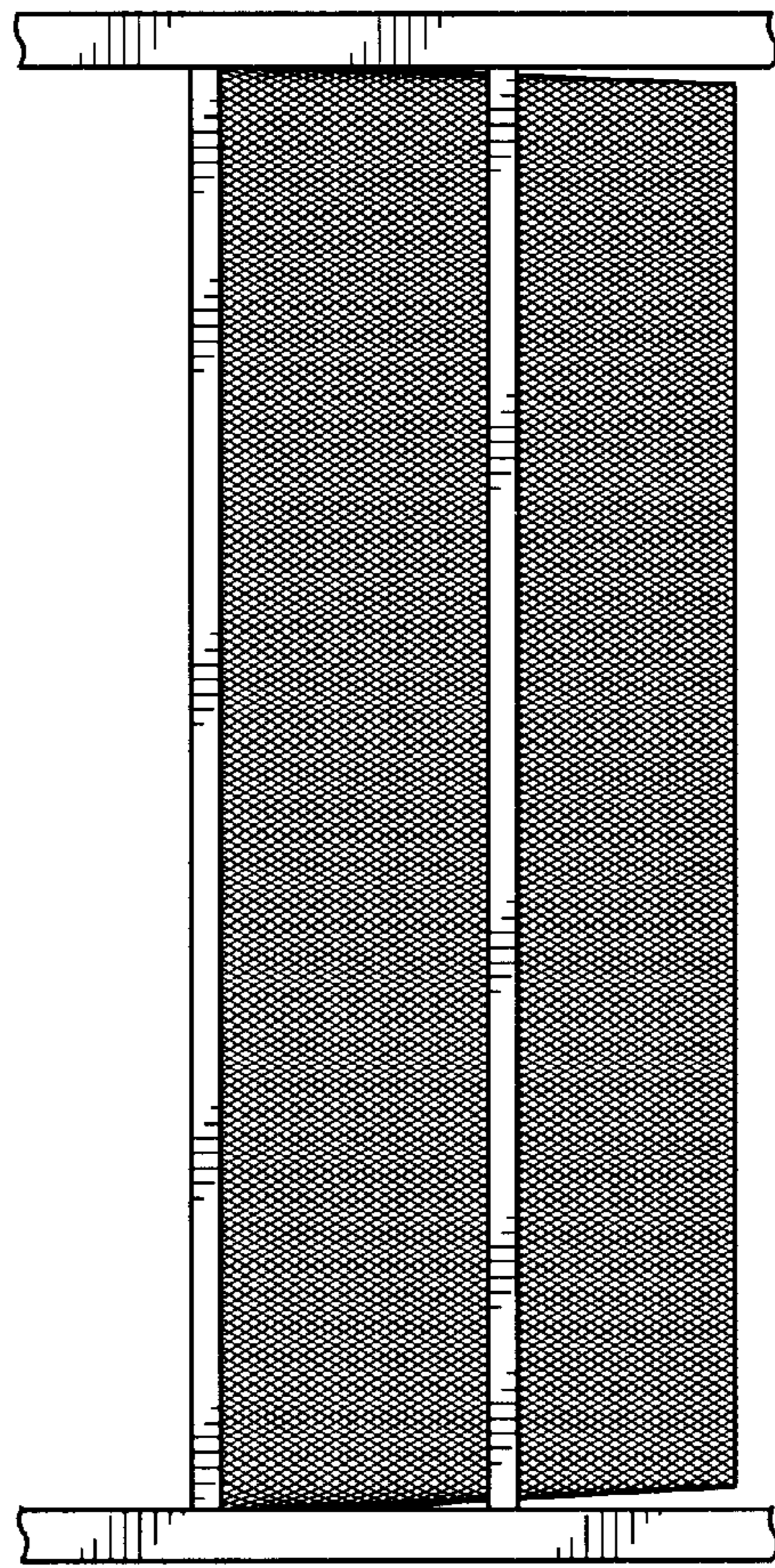

FIG. 40

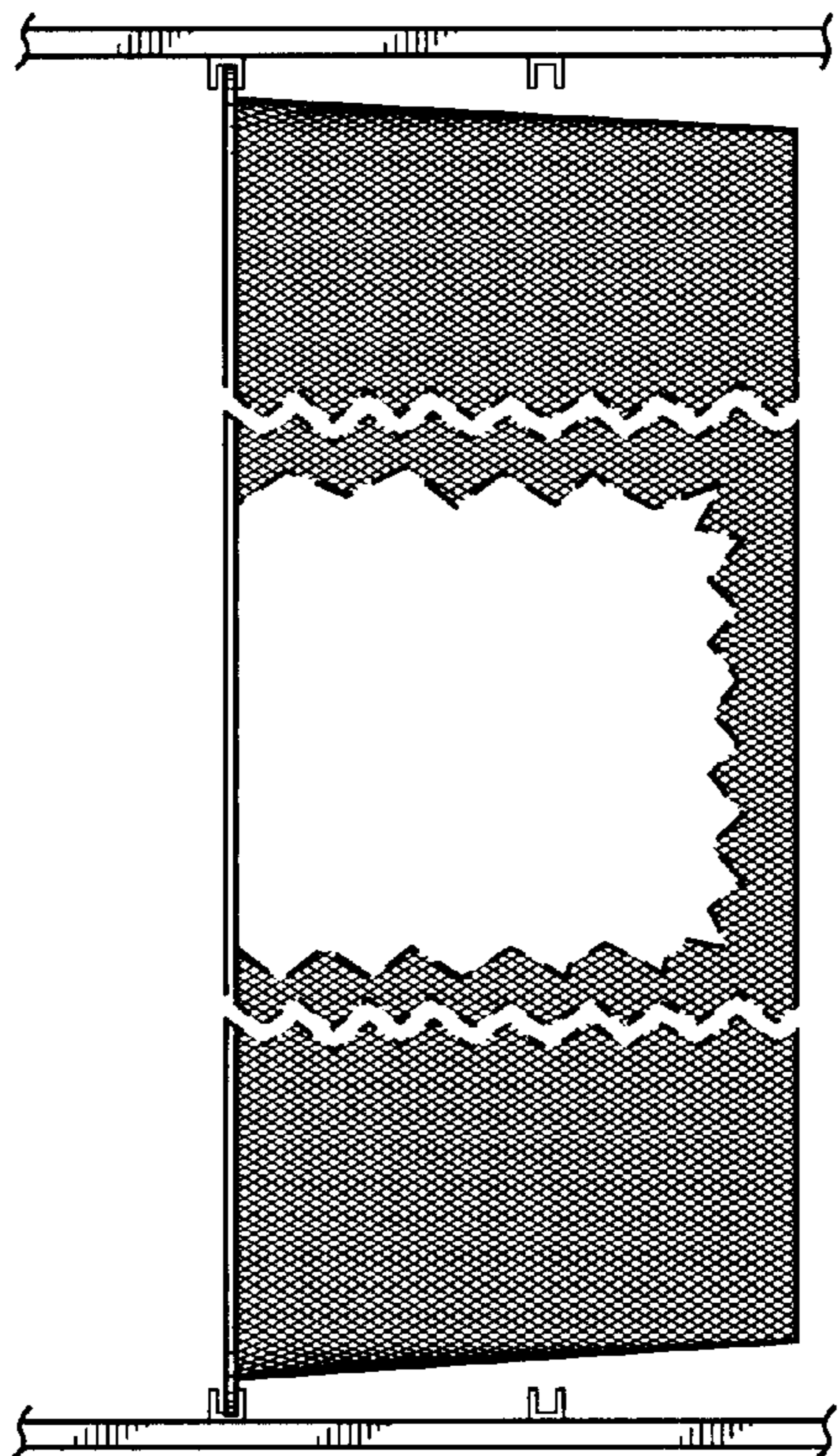

FIG. 39

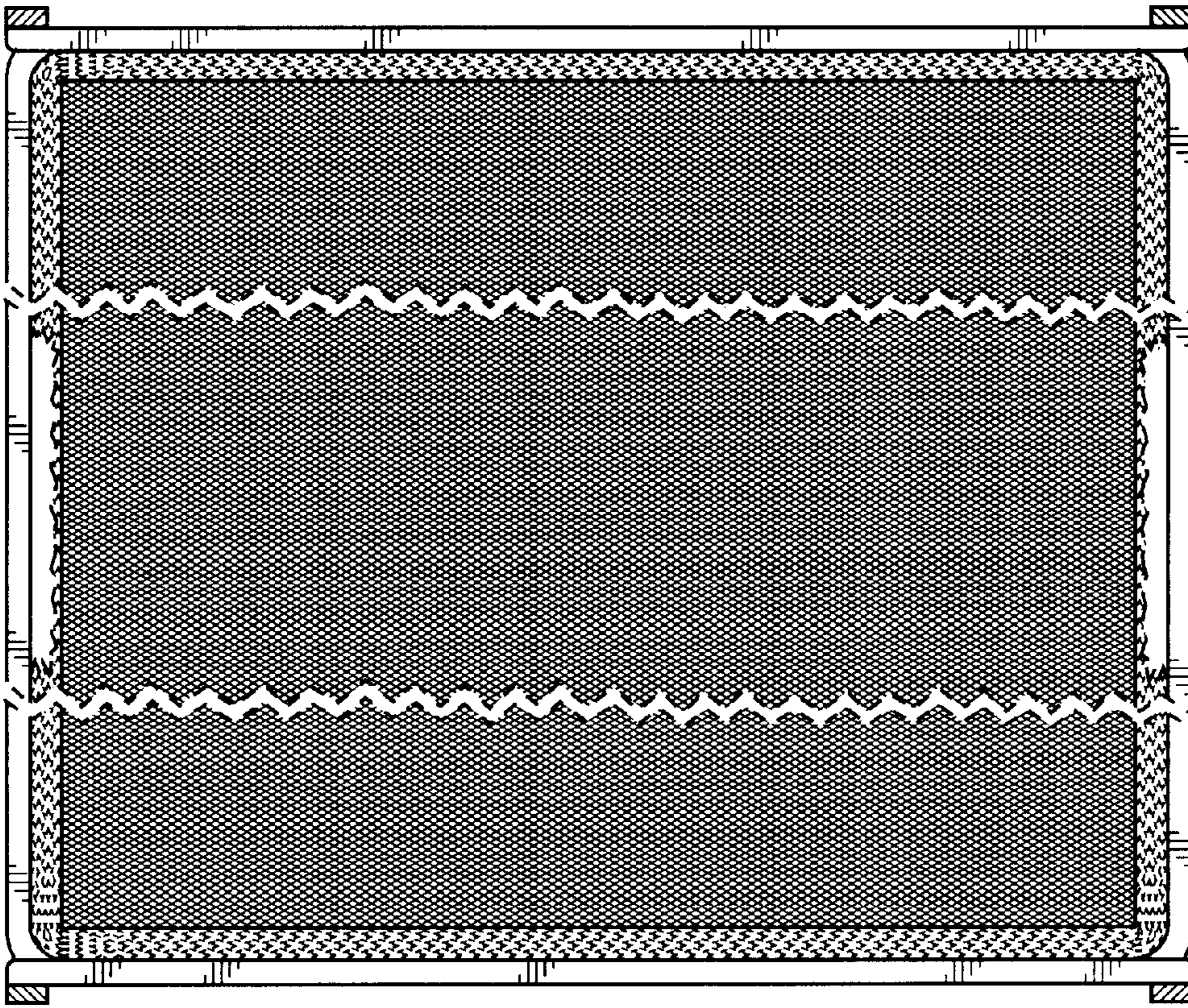

FIG.42

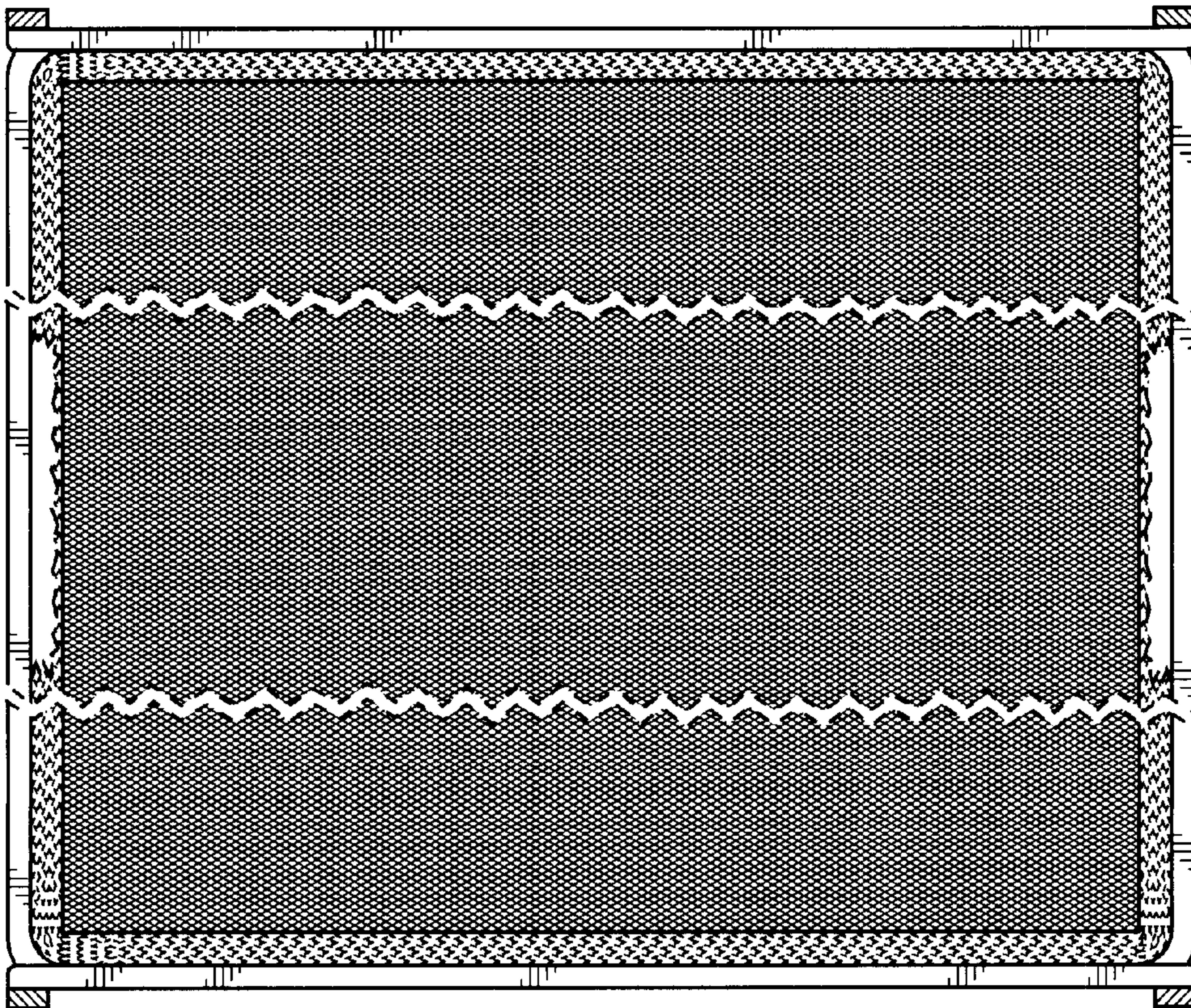

FIG.41

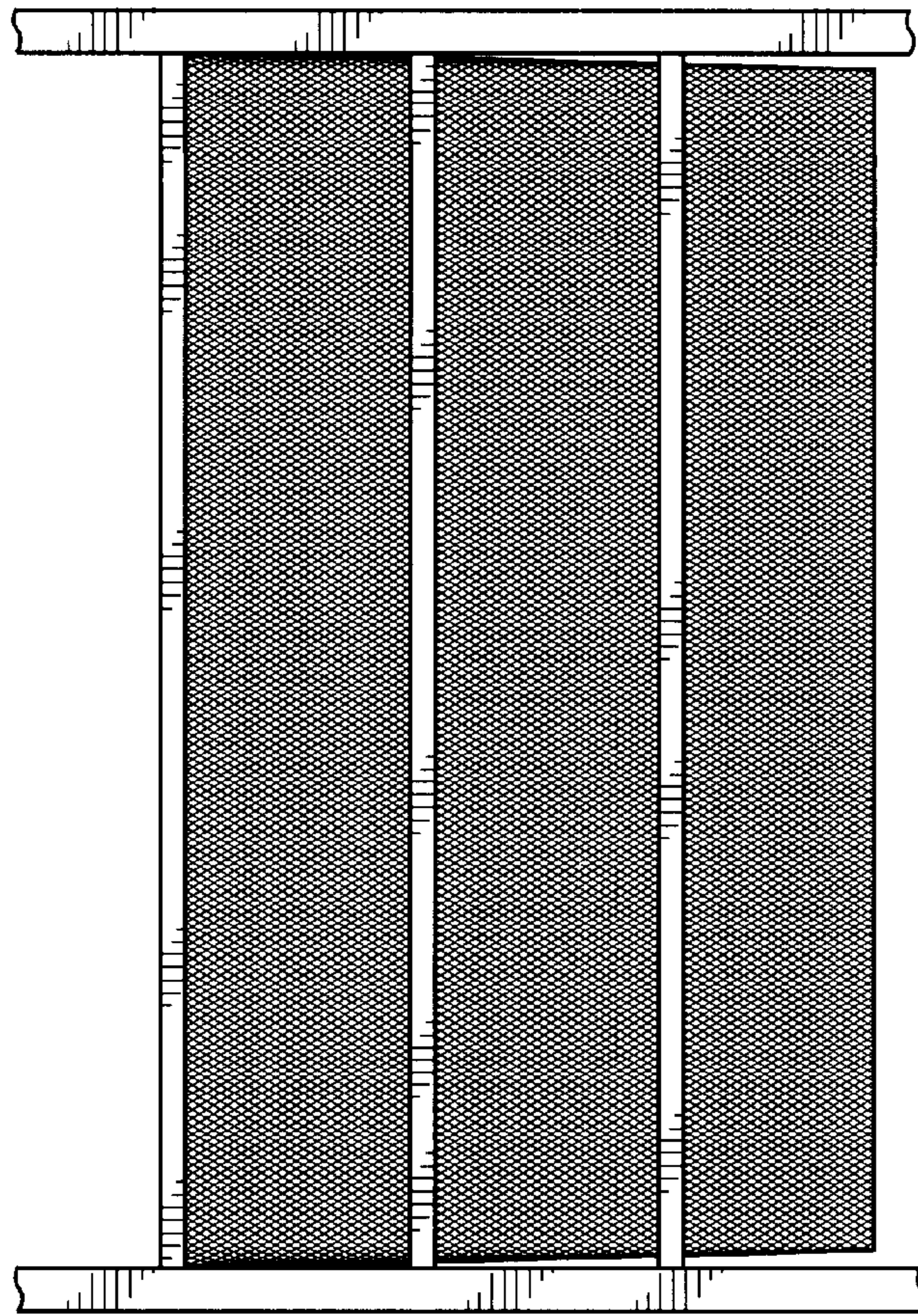

FIG. 44

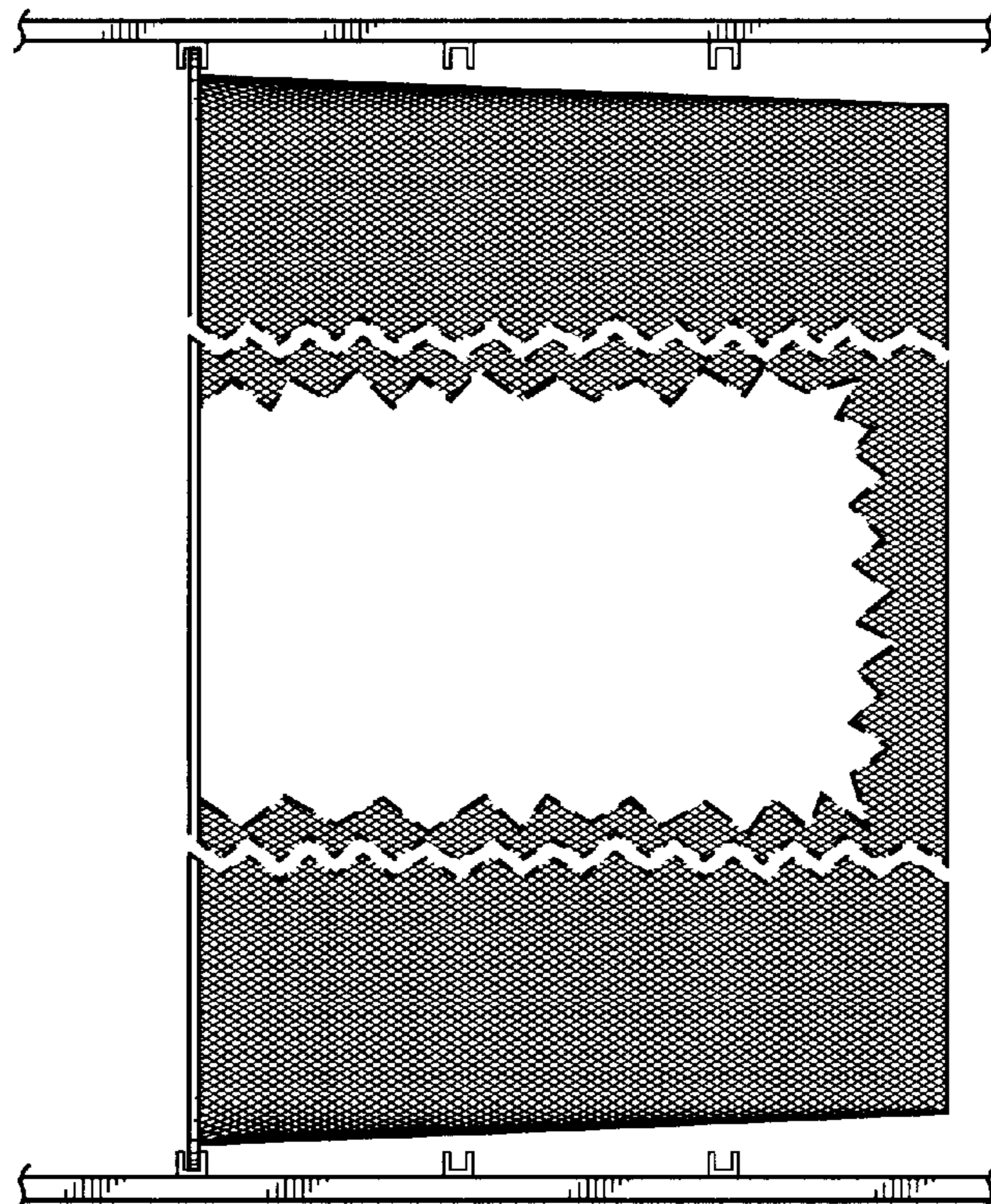

FIG. 43

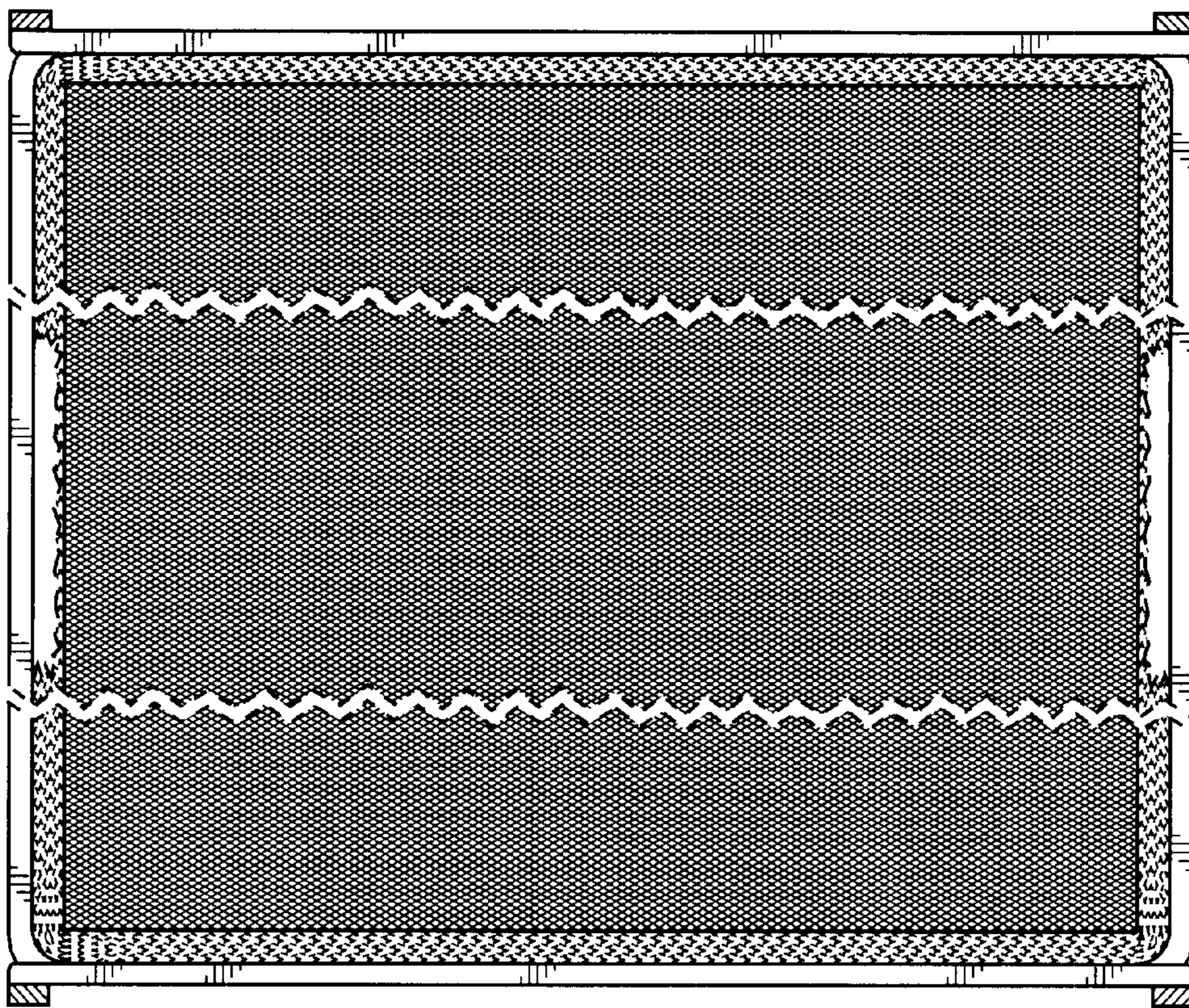

FIG. 46

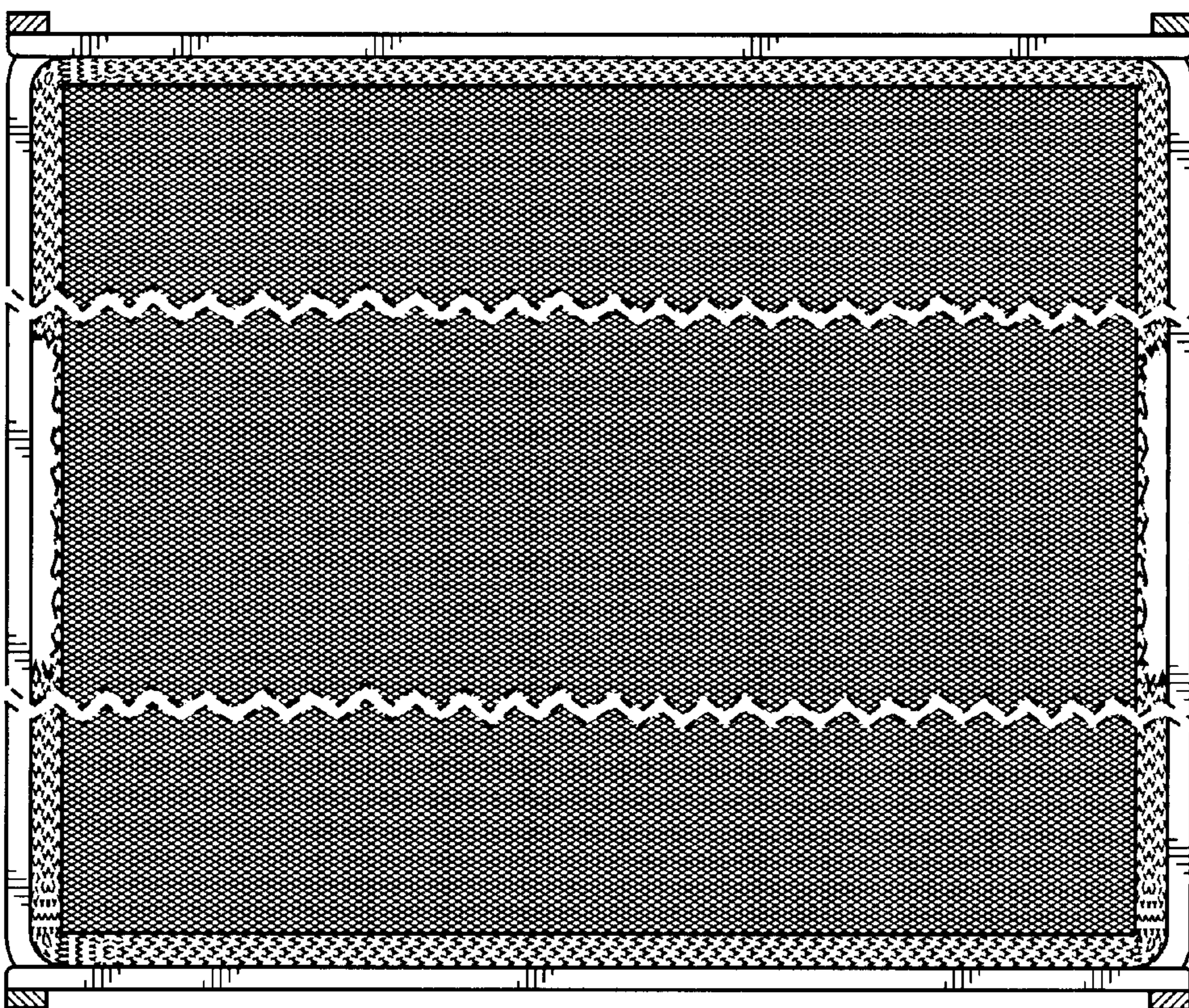

FIG. 45

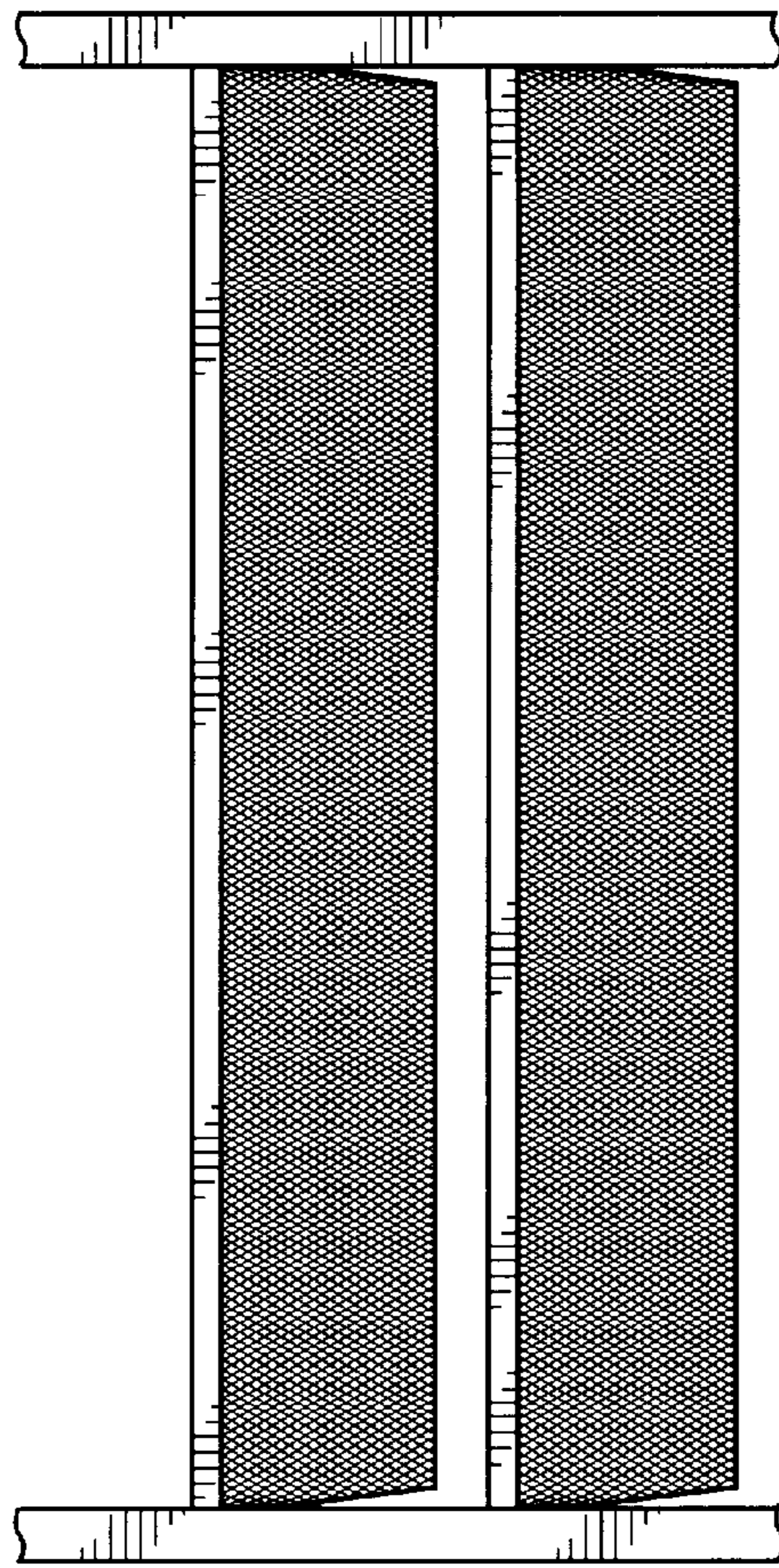

FIG. 48

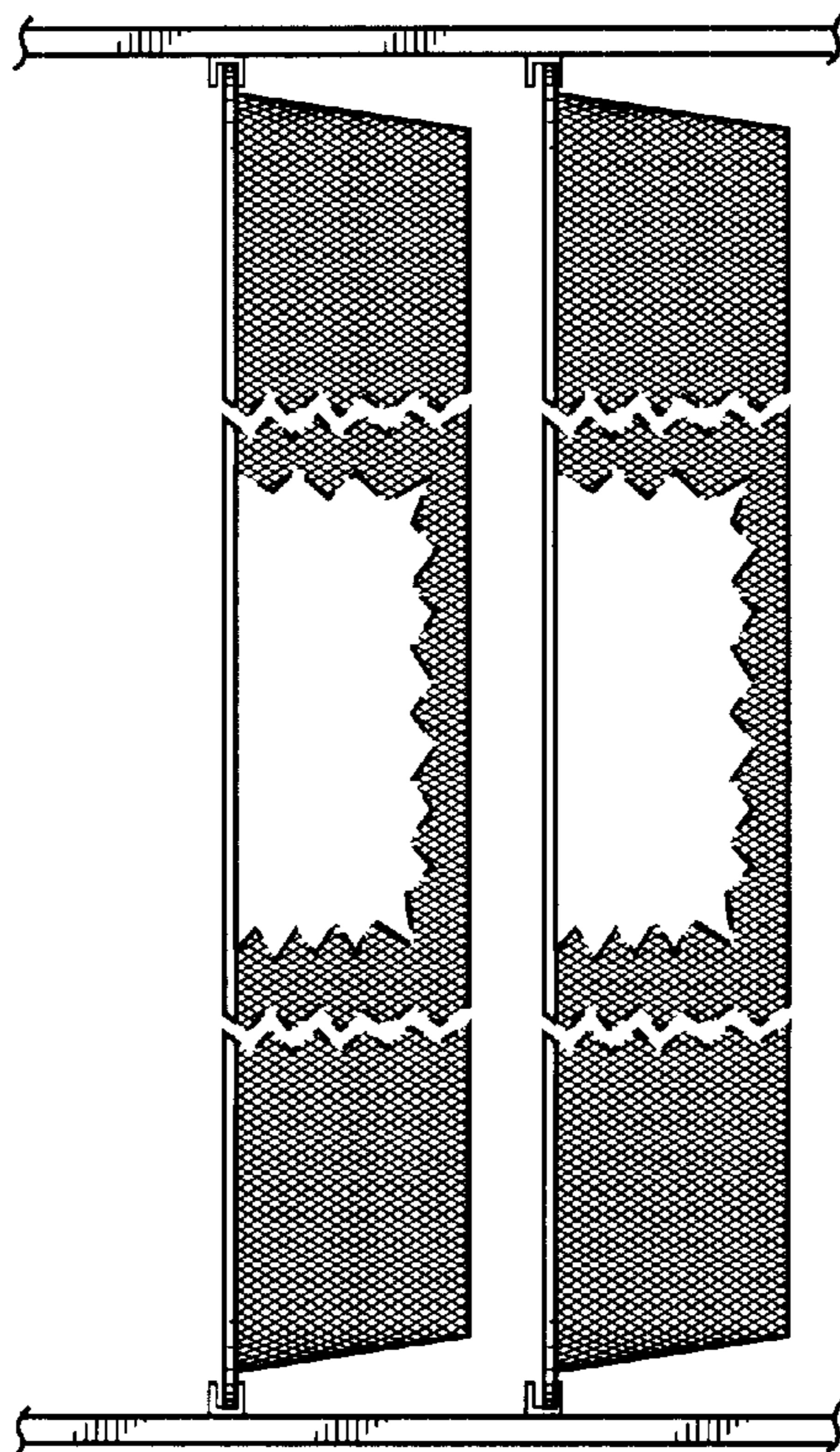

FIG. 47

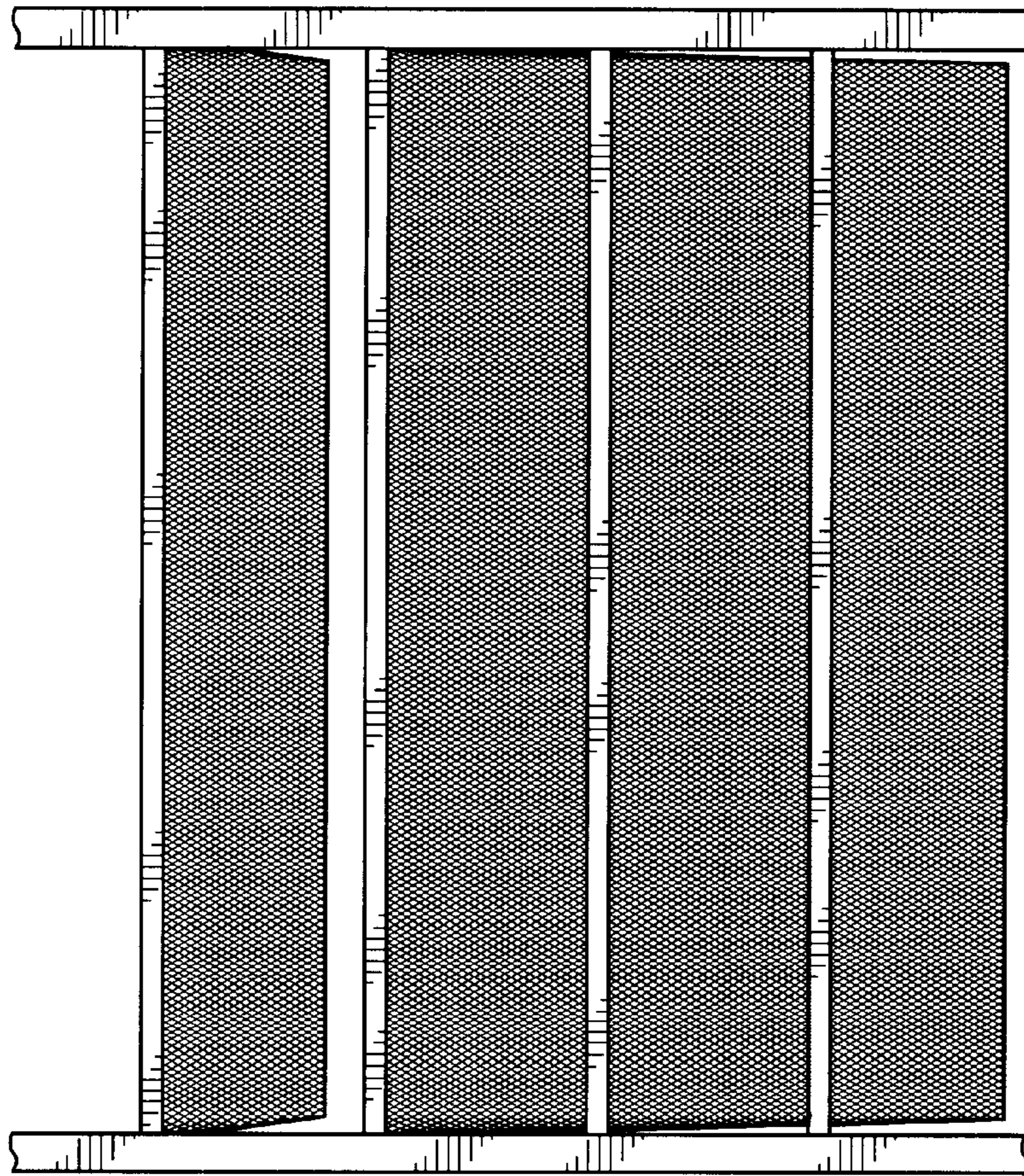

FIG. 50

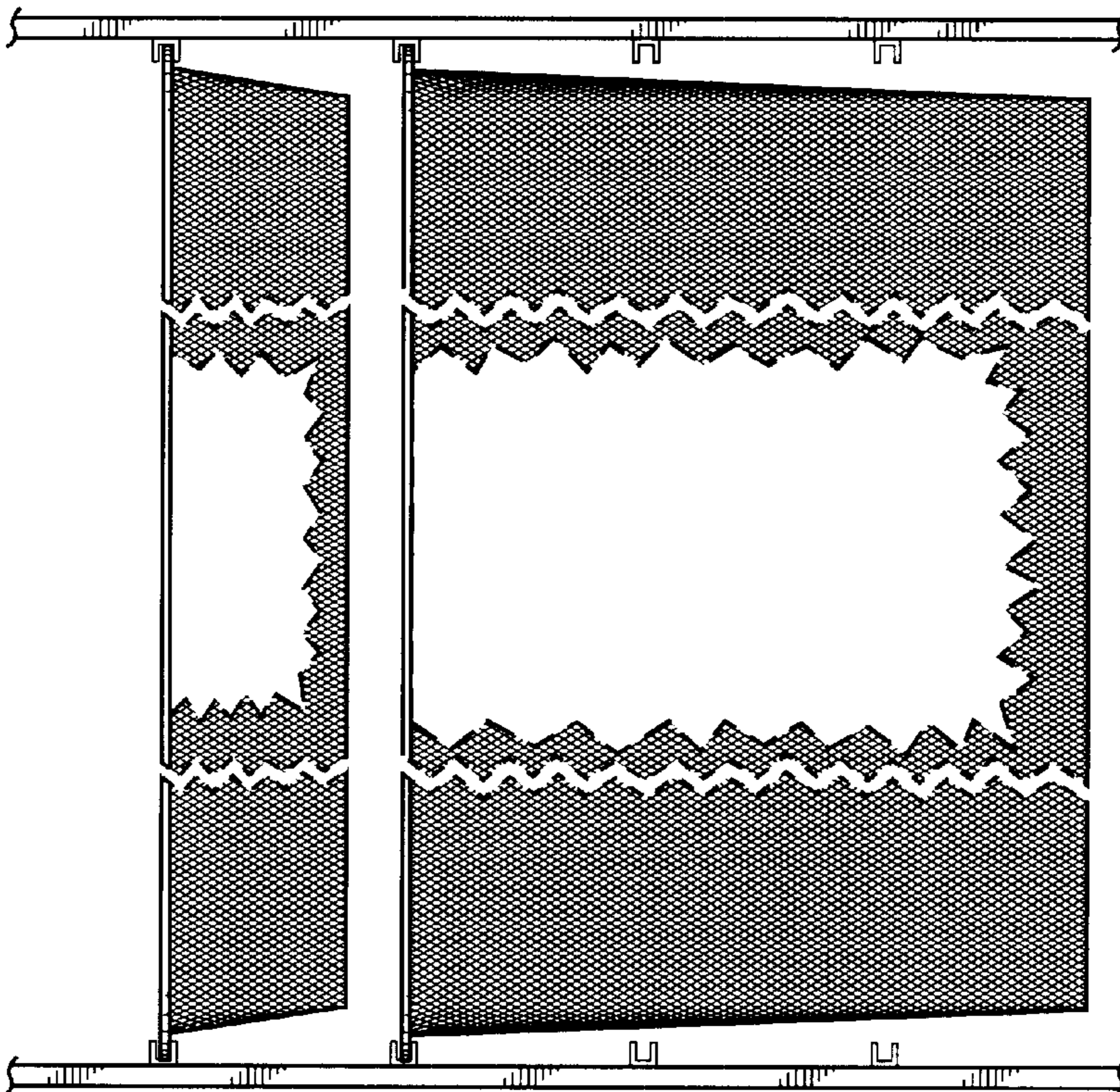

FIG. 49

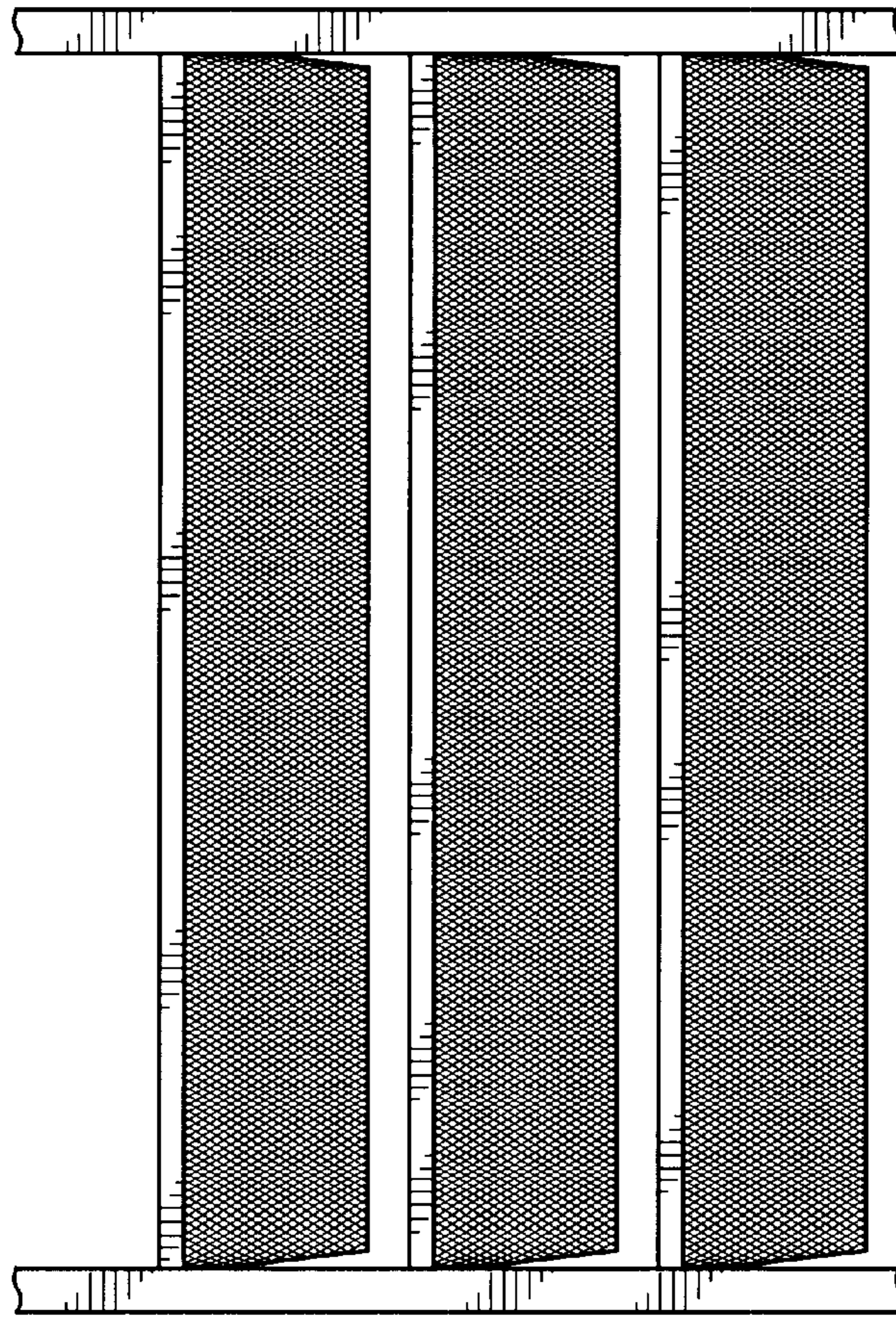

FIG. 52

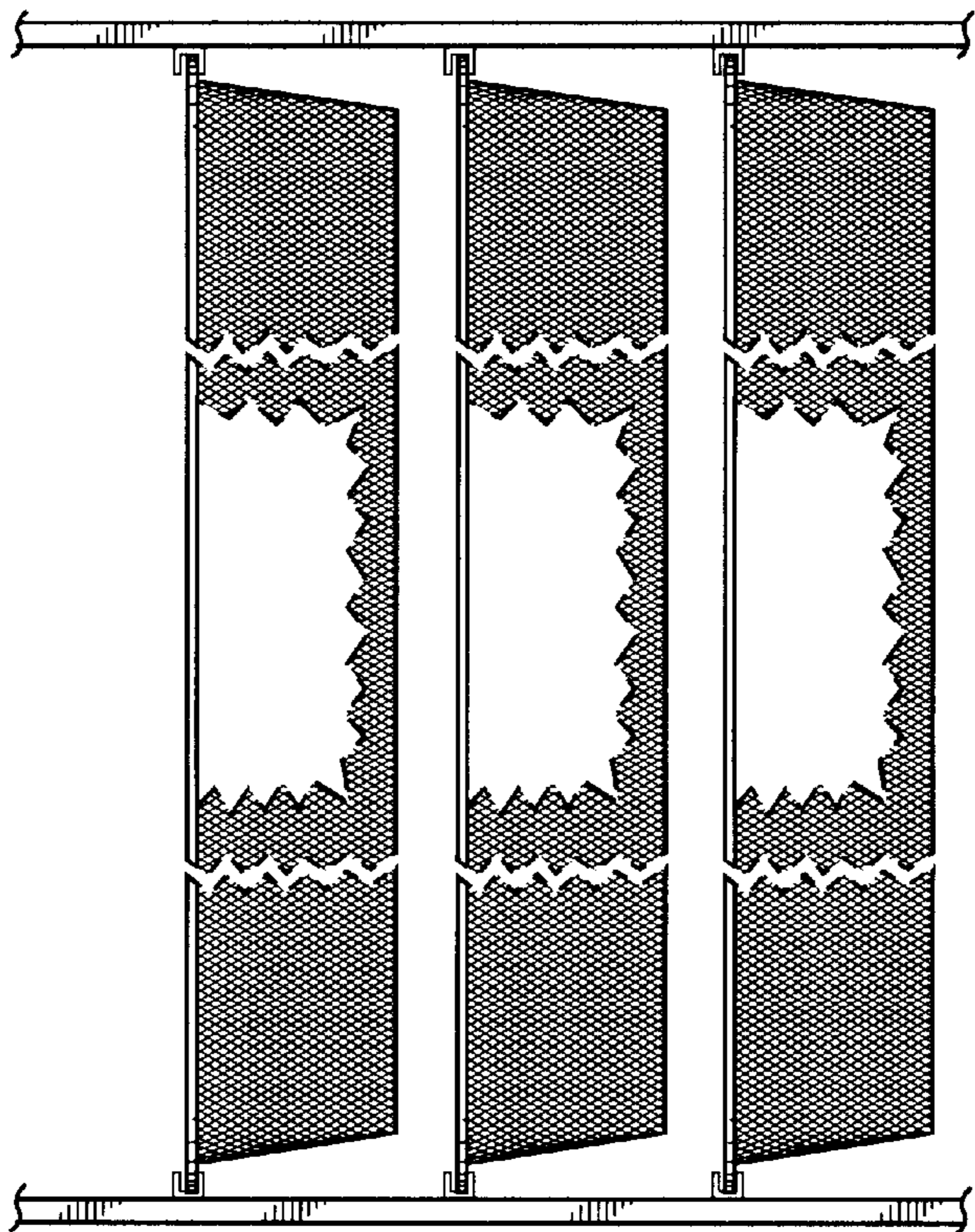

FIG. 51

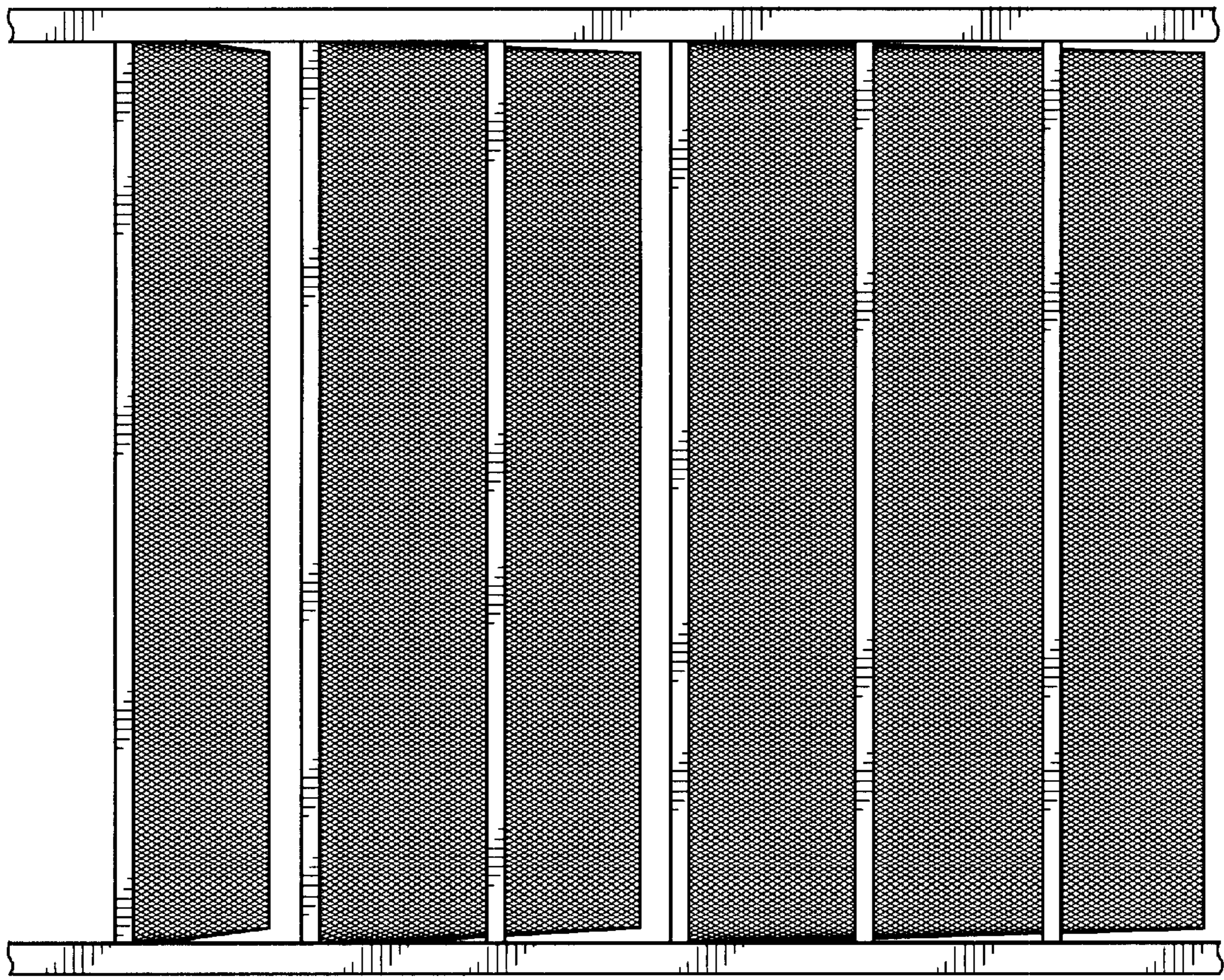

FIG. 54

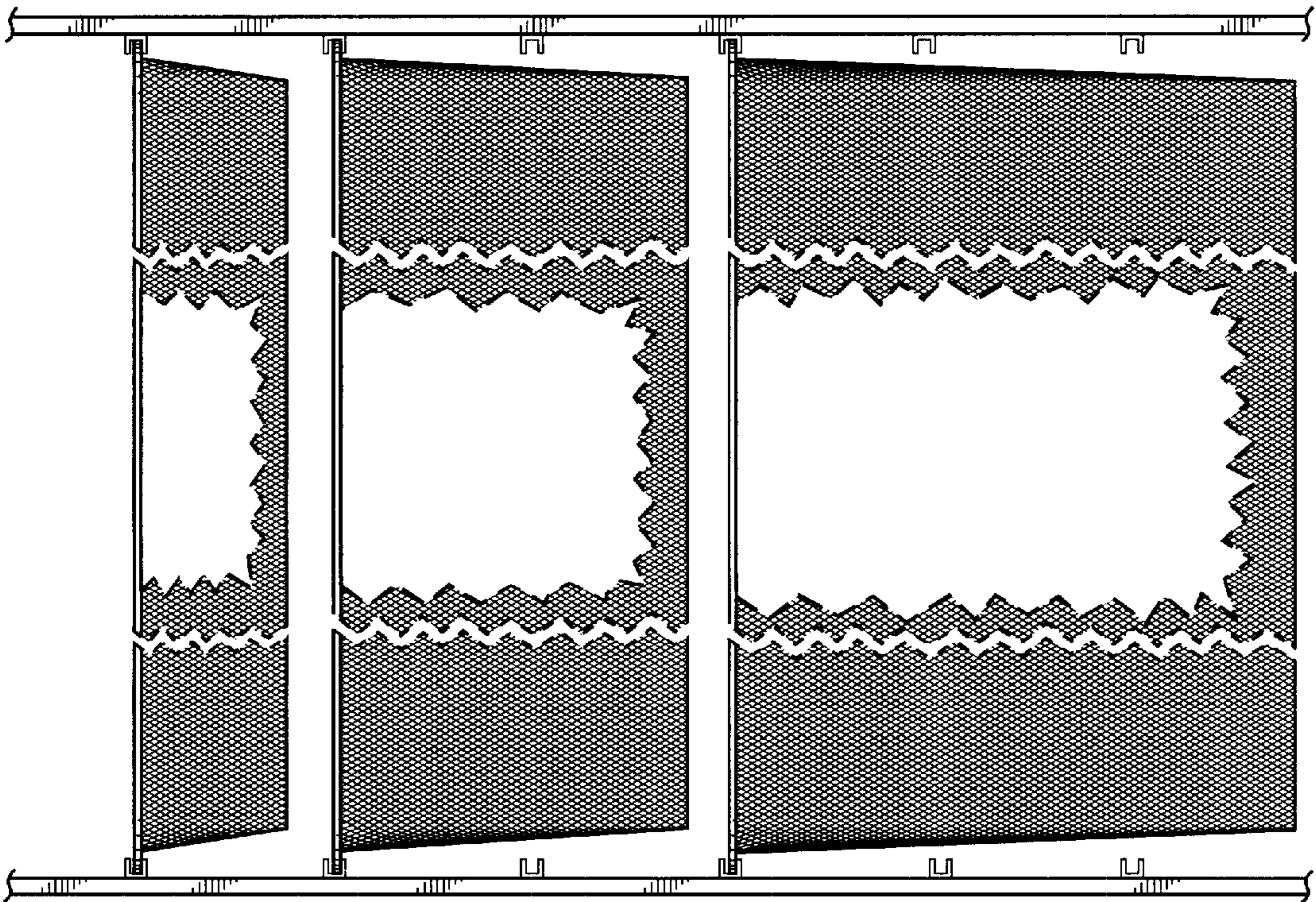

FIG. 53

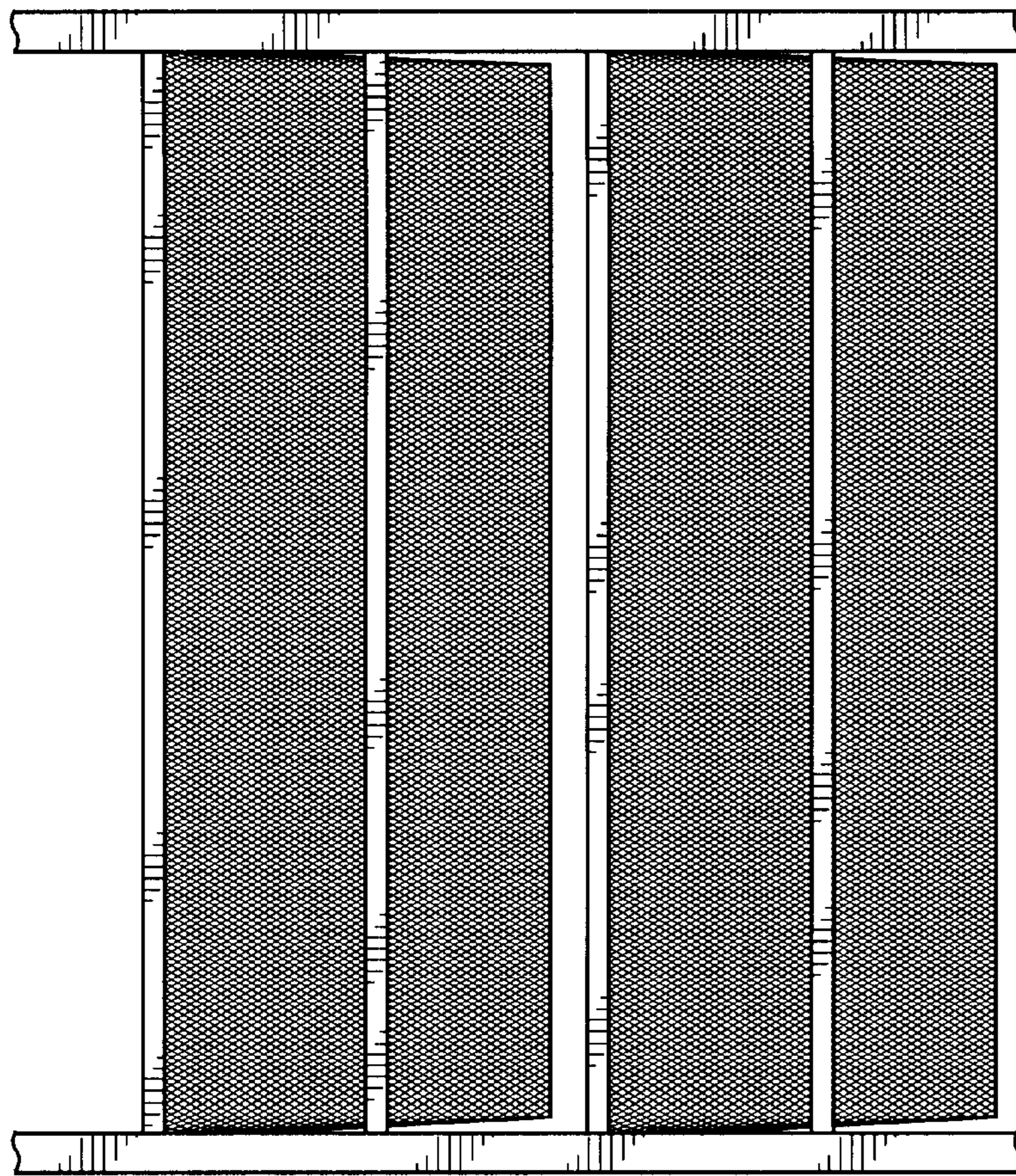

FIG. 56

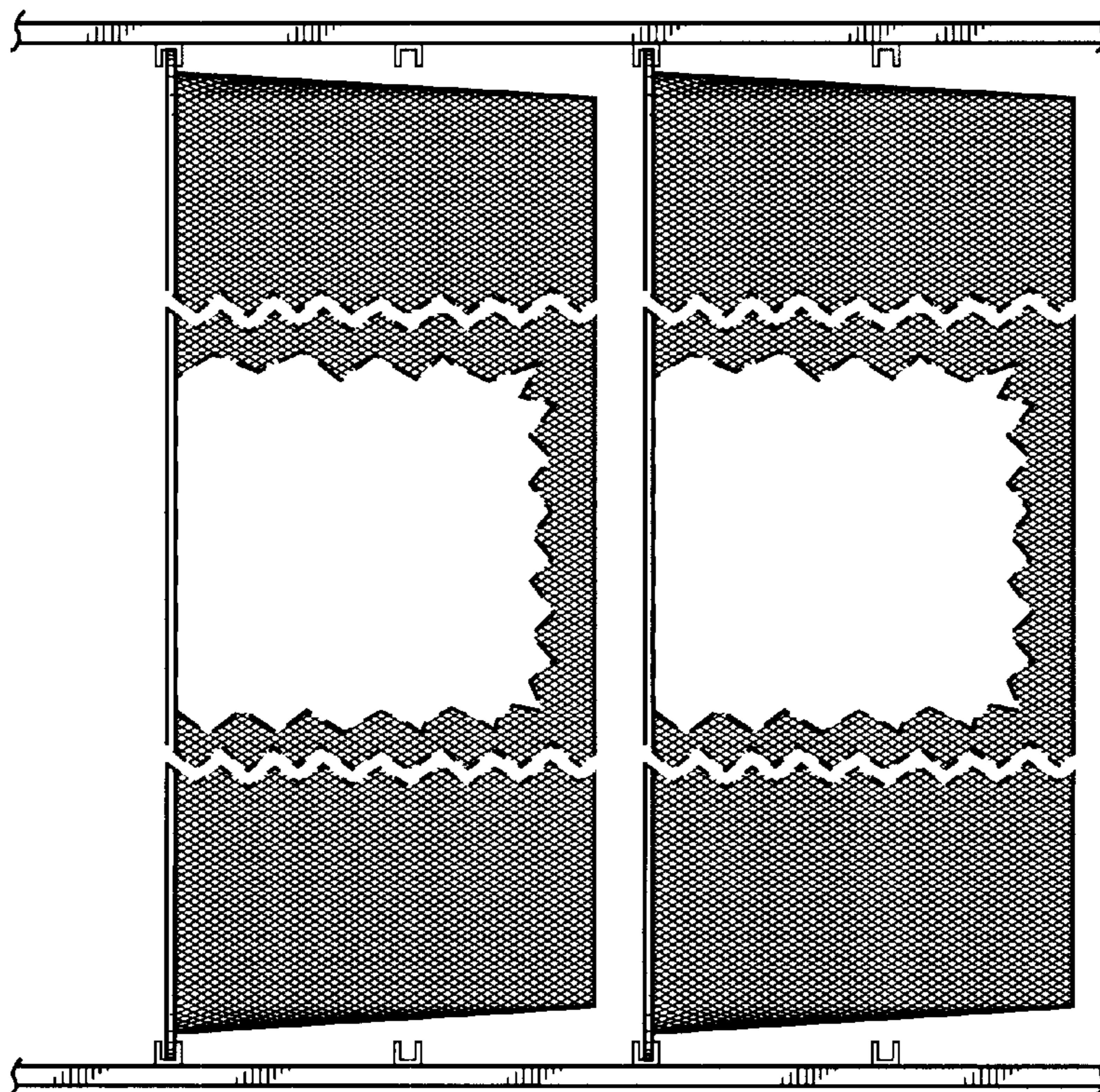

FIG. 55

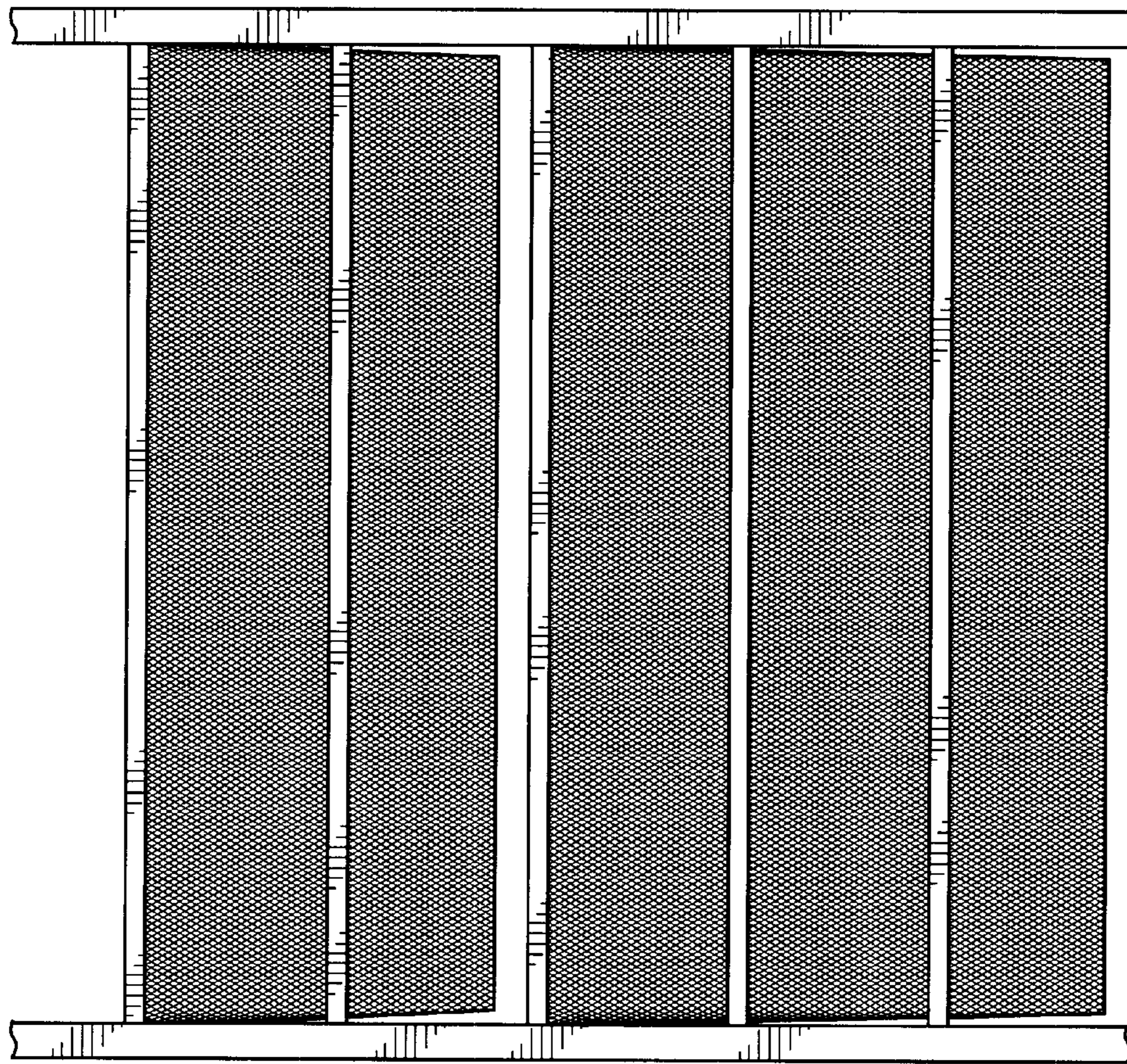

FIG. 58

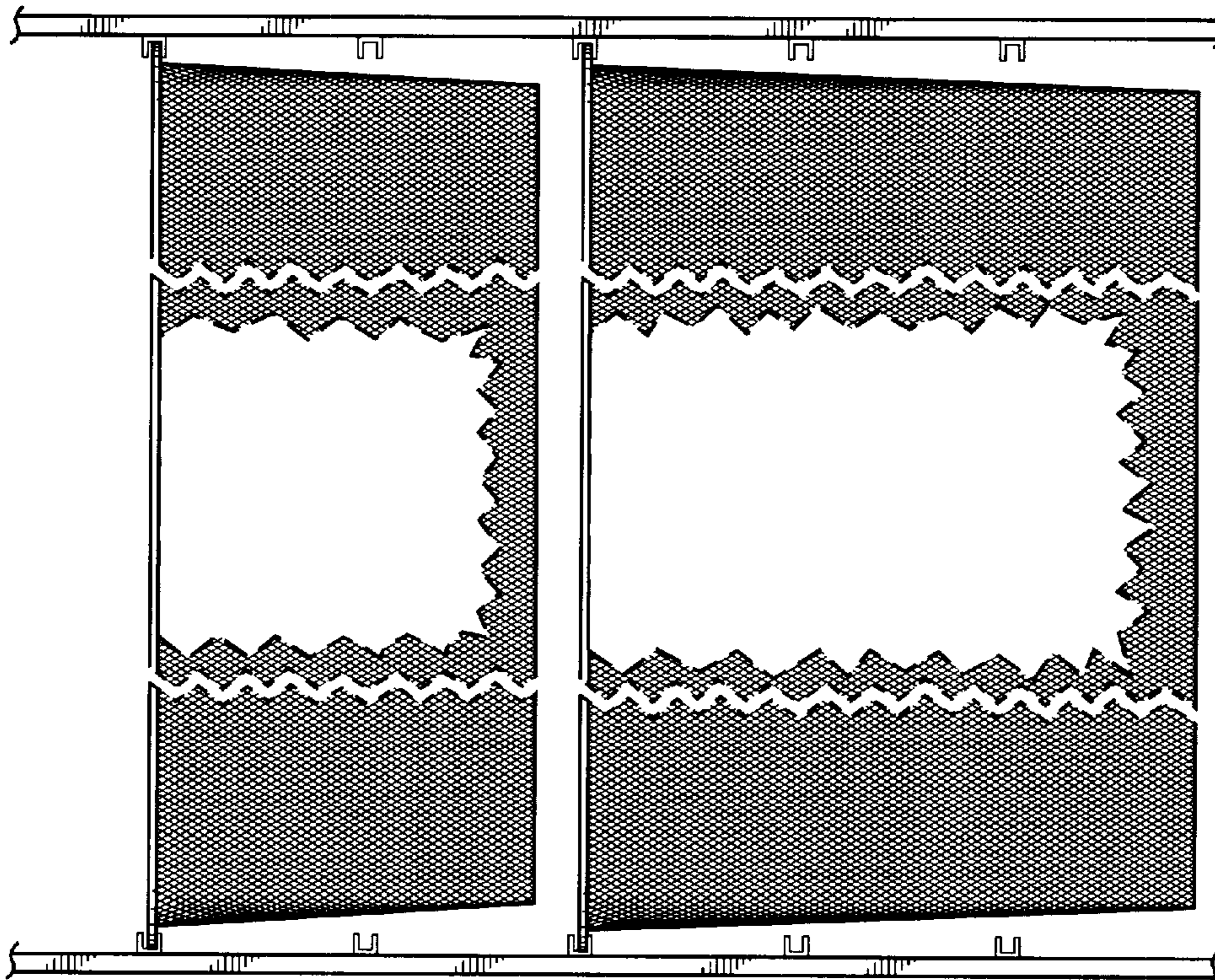

FIG. 57

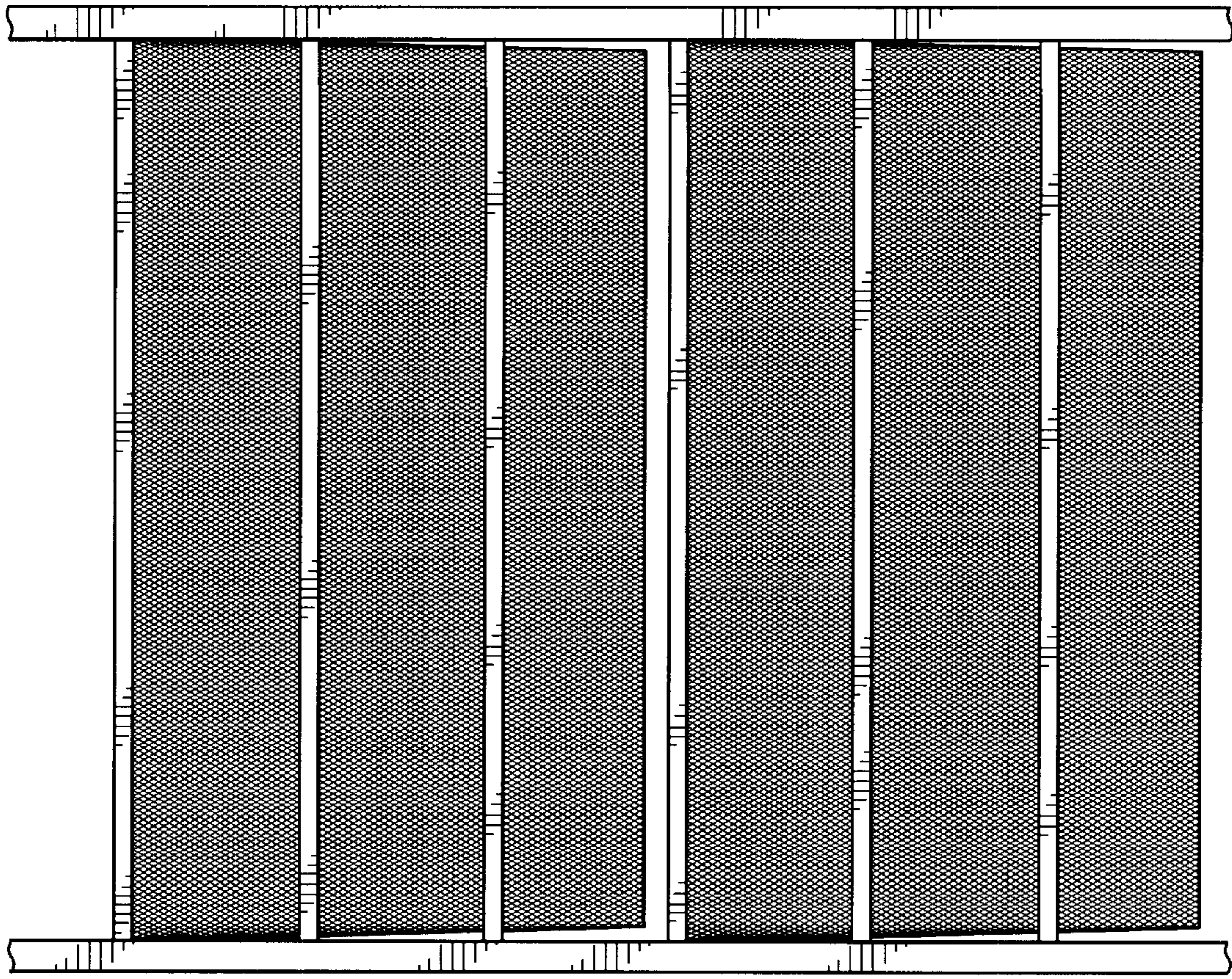

FIG. 60

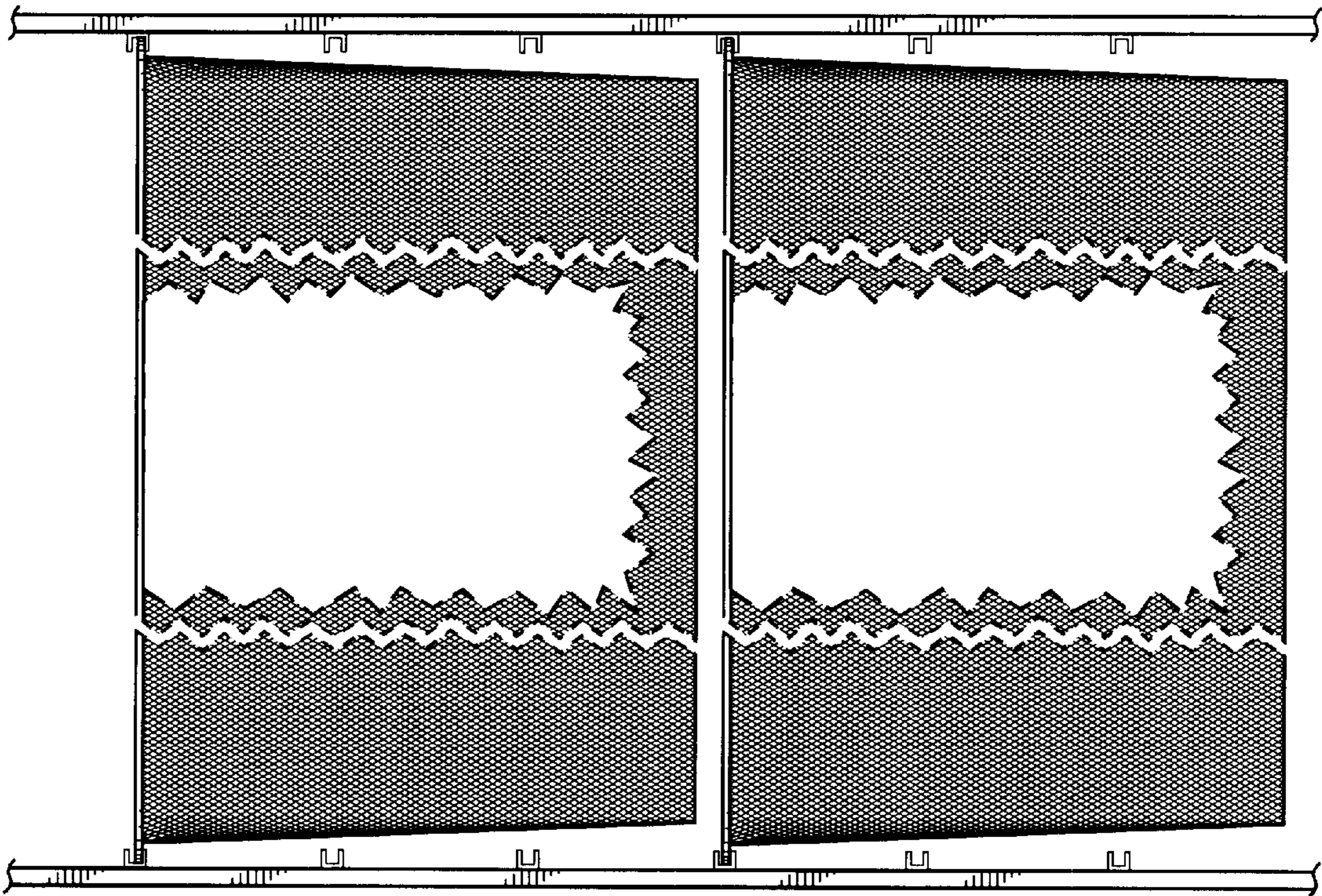

FIG. 59

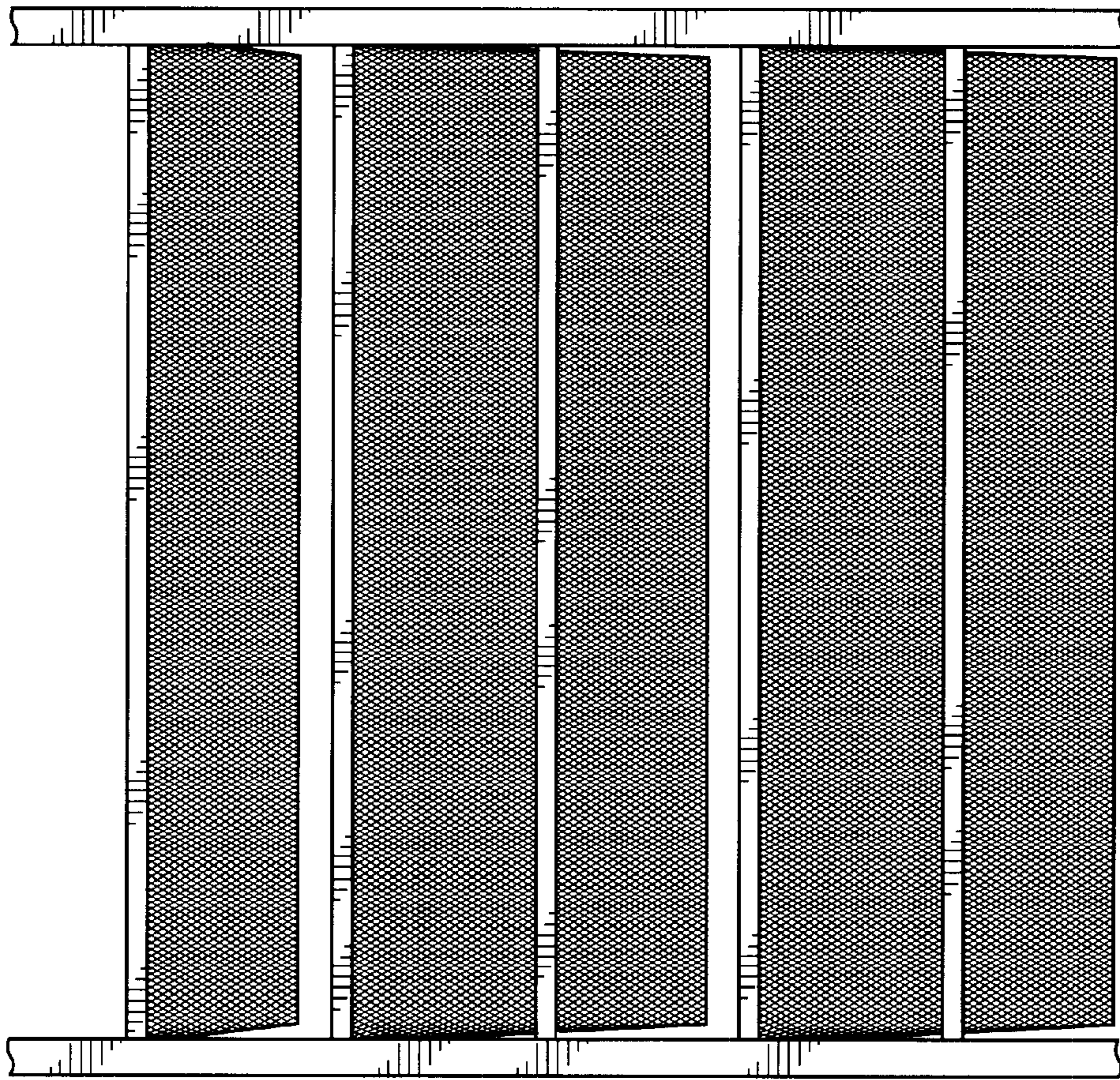

FIG. 62

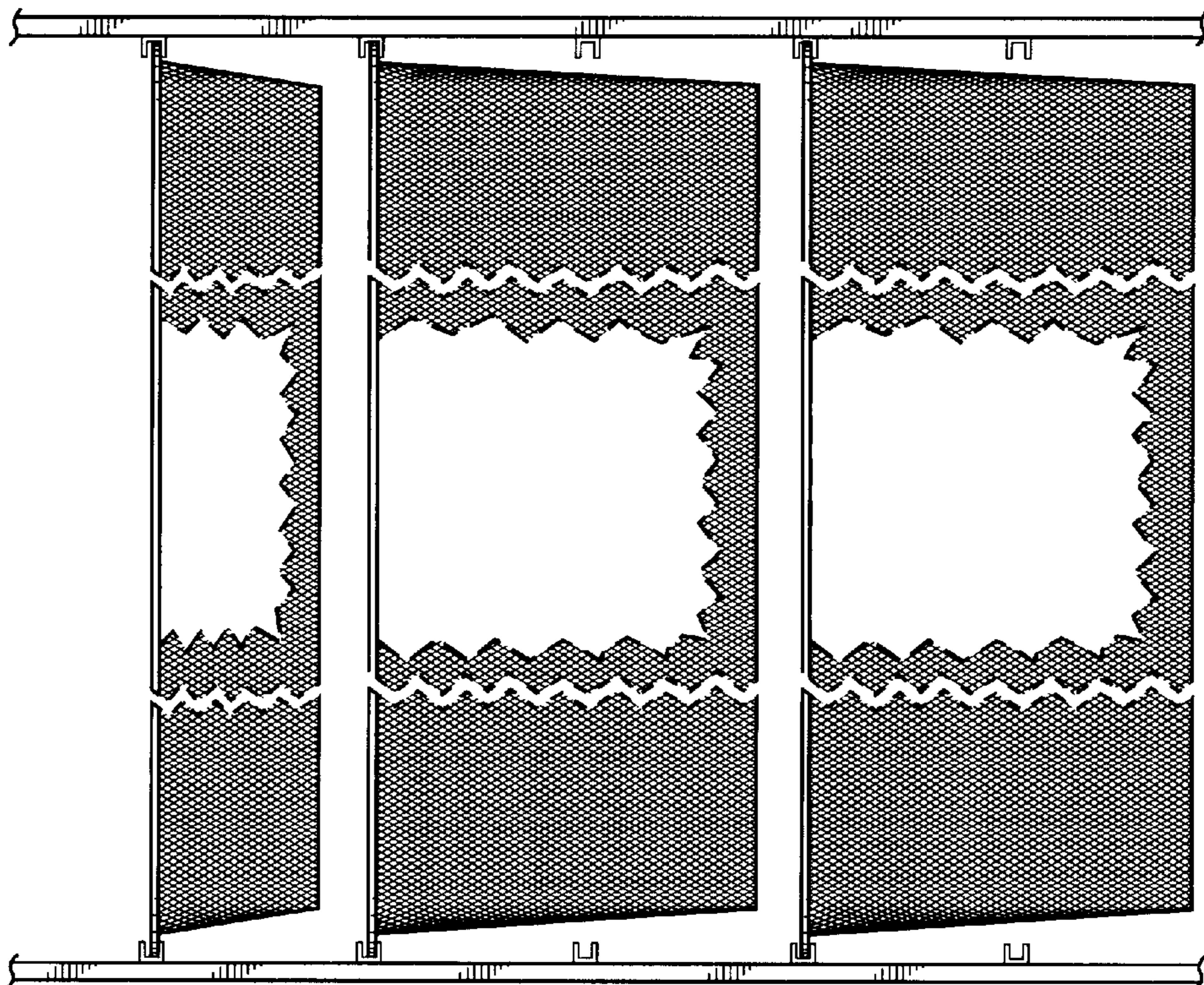

FIG. 61

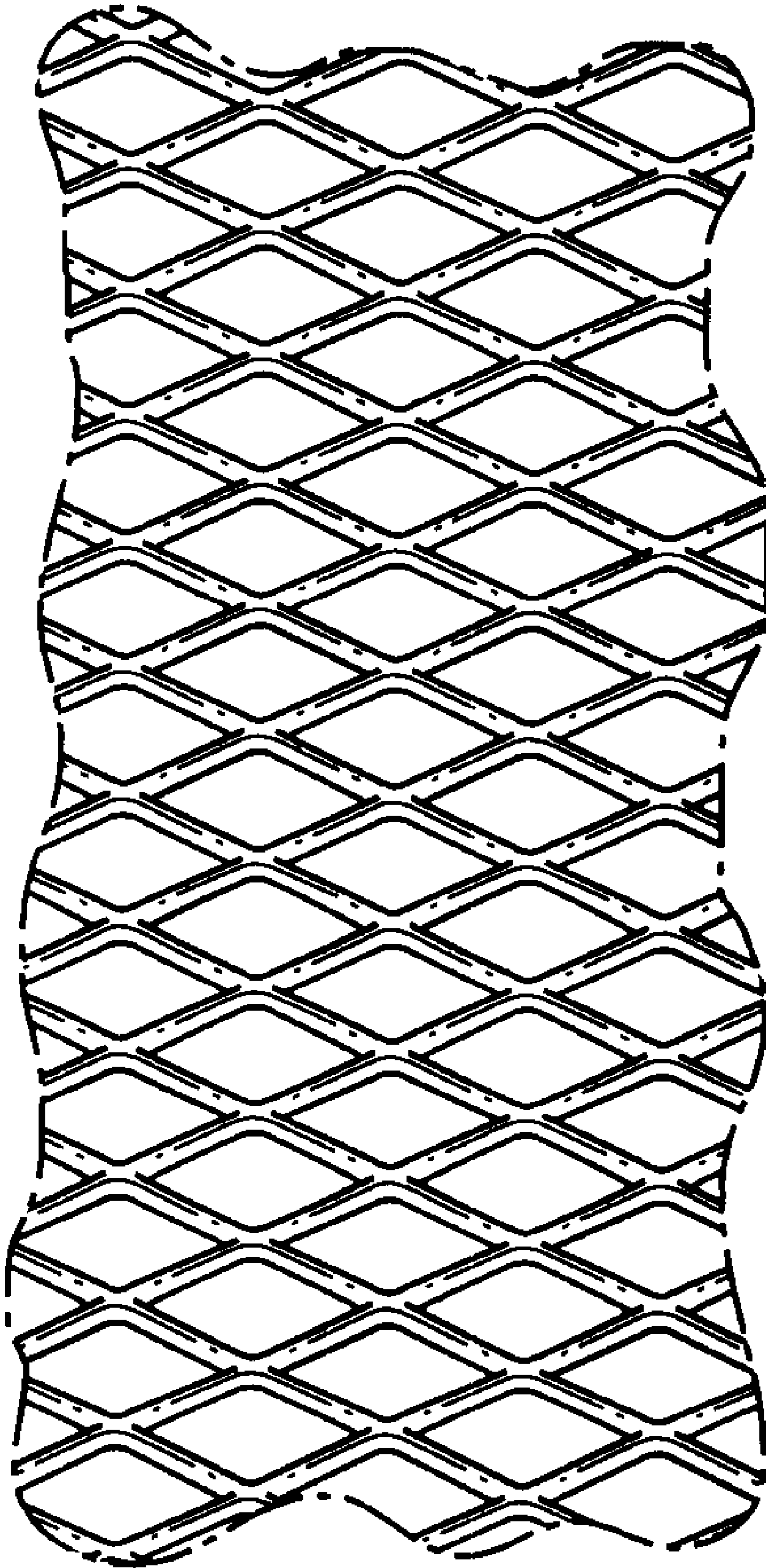

FIG. 63