



US00D481205S

(12) **United States Design Patent**  
**Parrott et al.**

(10) **Patent No.:** **US D481,205 S**

(45) **Date of Patent:** **\*\* Oct. 28, 2003**

(54) **TRAVELING IN-BOX**

(75) Inventors: **Melissa A. Parrott**, Boynton Beach, FL (US); **Sue F. Steffey**, Tamarac, FL (US)

(73) Assignee: **Levenger Company**, Delray Beach, FL (US)

(\*\*) Term: **14 Years**

(21) Appl. No.: **29/172,242**

(22) Filed: **Dec. 9, 2002**

(51) **LOC (7) Cl.** ..... **03-01**

(52) **U.S. Cl.** ..... **D3/301; D3/299; D19/86**

(58) **Field of Search** ..... D3/273, 274, 276, D3/289, 299, 301; D19/86, 92, 65, 75; 206/555; 190/100, 902; 248/460, 450, 441.1

(56) **References Cited**

**U.S. PATENT DOCUMENTS**

D330,804 S \* 11/1992 Massro et al. .... D3/299  
D338,104 S \* 8/1993 Lee ..... D3/287

D358,935 S \* 6/1995 Chang et al. .... D3/289  
D439,742 S \* 4/2001 Fujino et al. .... D3/290  
D451,551 S \* 12/2001 Guy et al. .... D19/86

\* cited by examiner

*Primary Examiner*—Philip S. Hyder

(74) *Attorney, Agent, or Firm*—Akerman Senterfitt

(57) **CLAIM**

The ornamental design for a traveling in-box, as shown and described.

**DESCRIPTION**

FIG. 1 is a perspective view of our new design; FIG. 2 is a front side elevation view; FIG. 3 is a rear elevation view; FIG. 4 is a right side elevation view; FIG. 5 is a left side elevation view; FIG. 6 is a top elevation view; FIG. 7 is a bottom elevation view; and, FIG. 8 is a perspective view with the flap open of our new design.

**1 Claim, 4 Drawing Sheets**

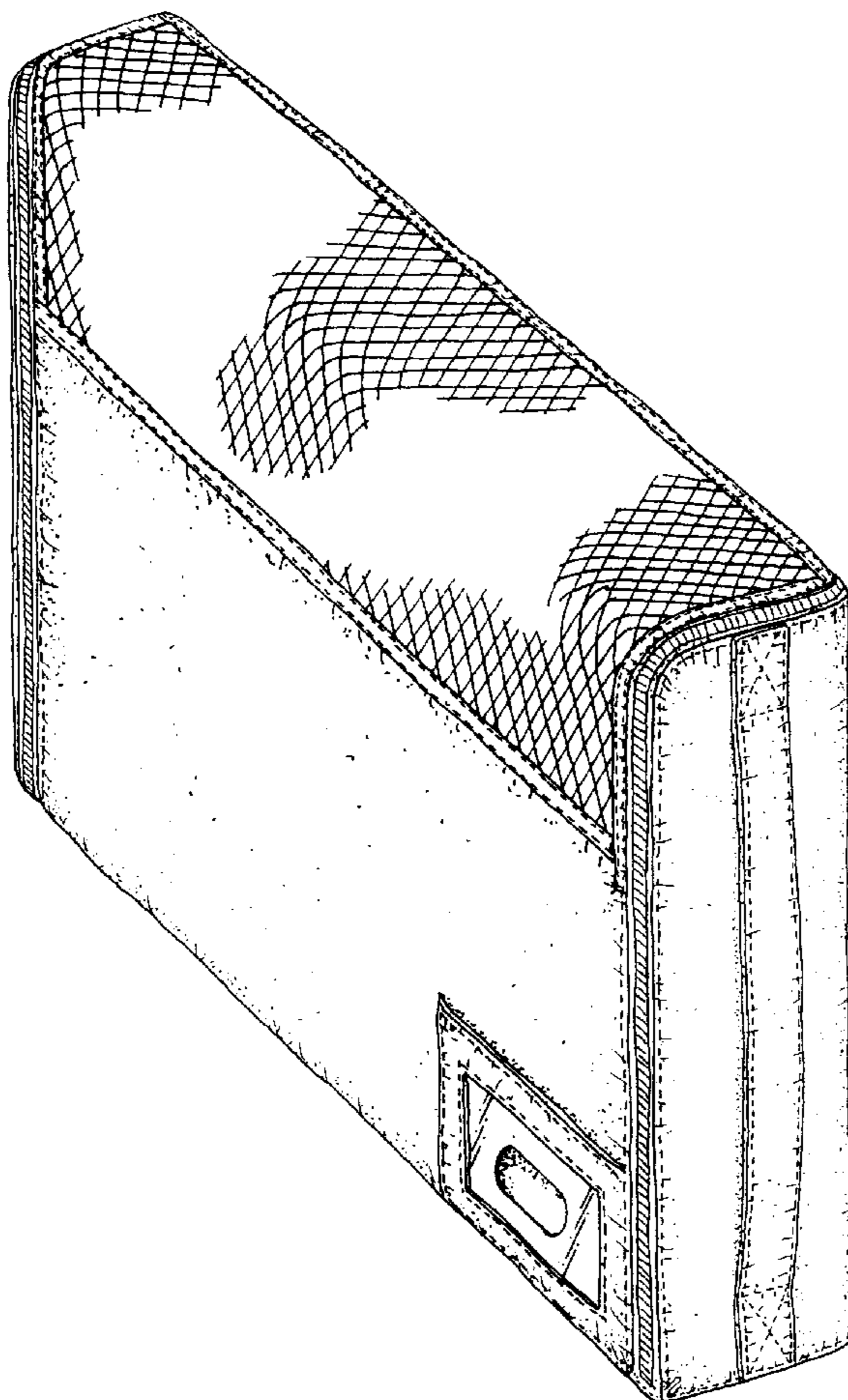

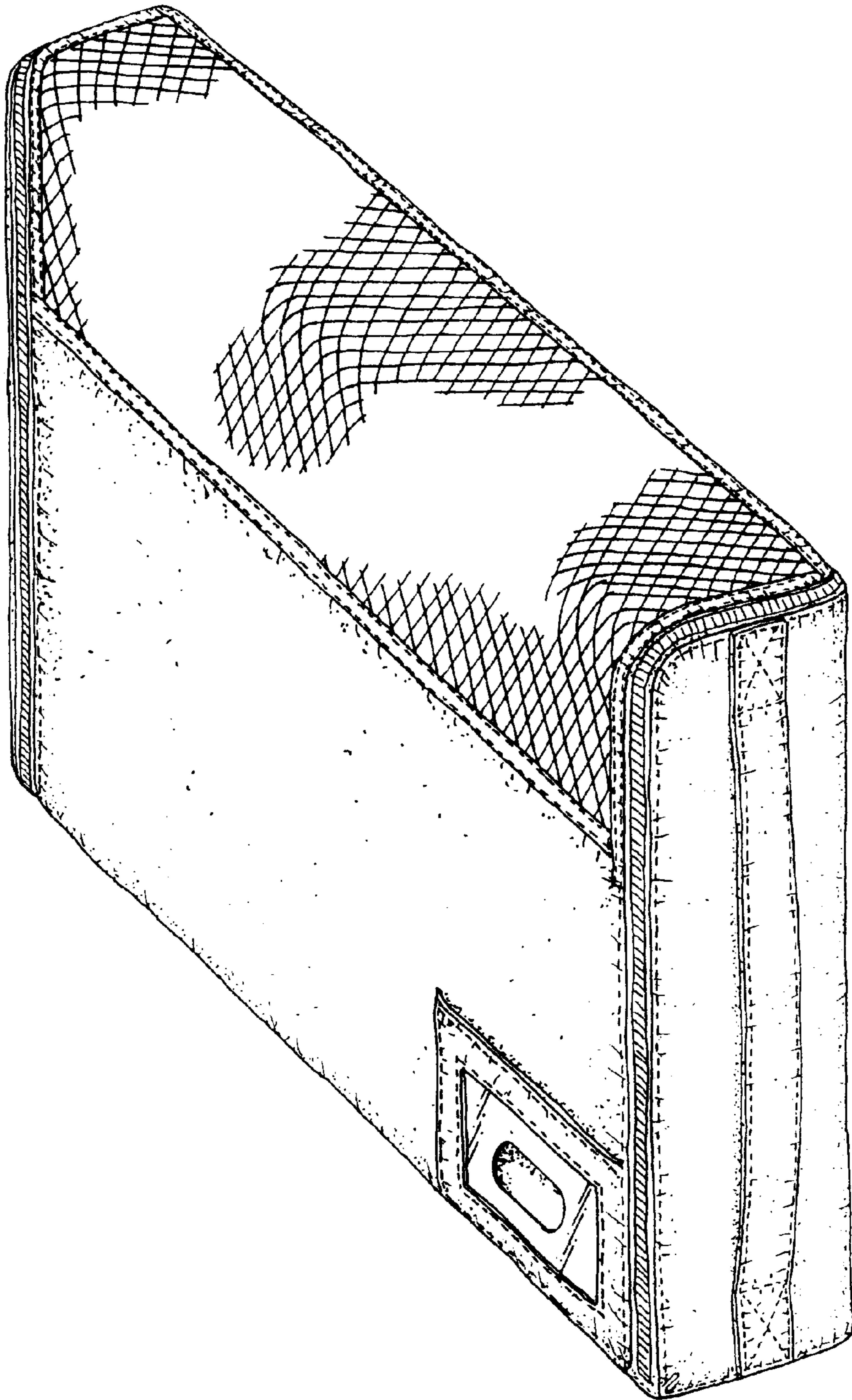

FIG. 1

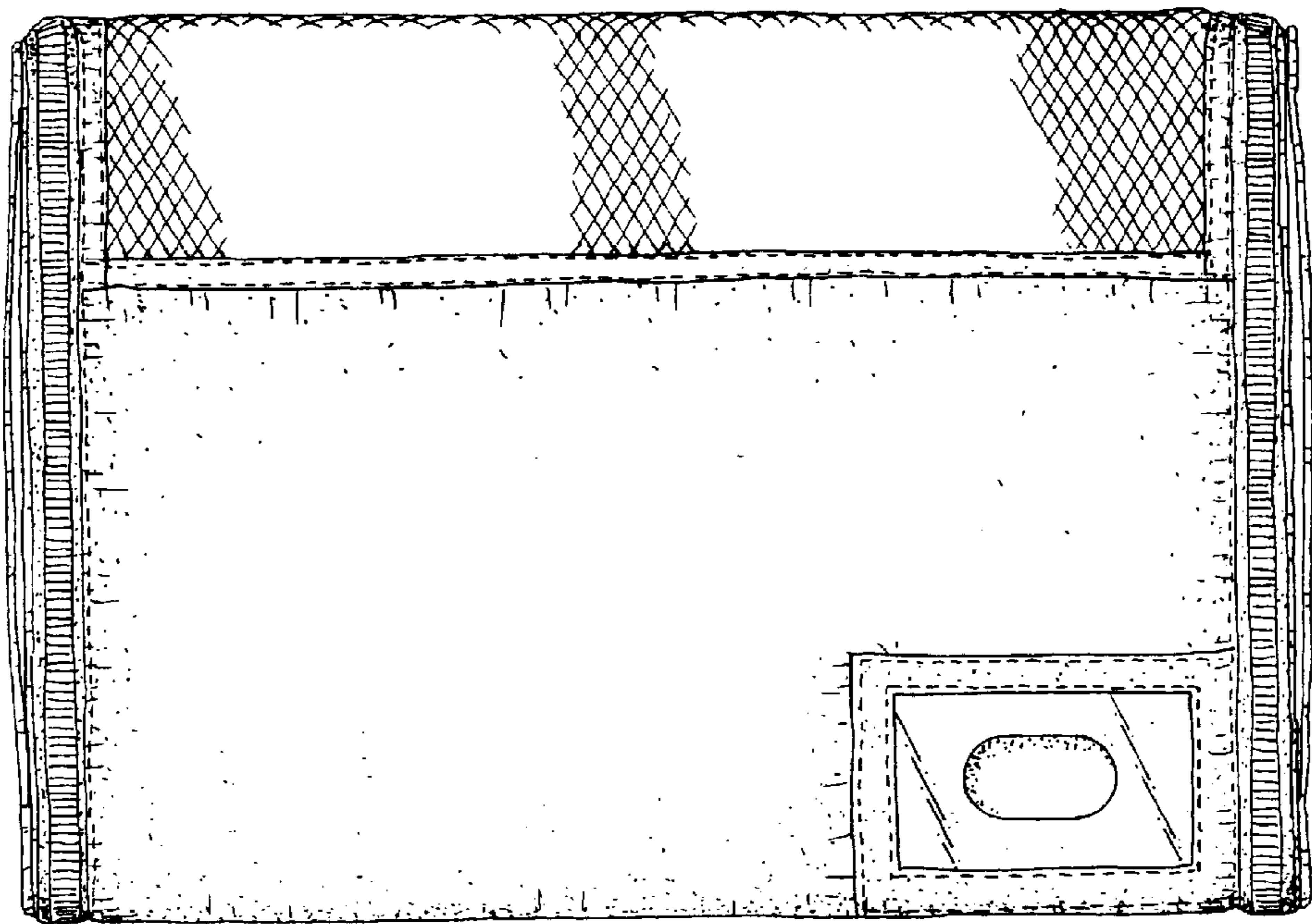

FIG. 2

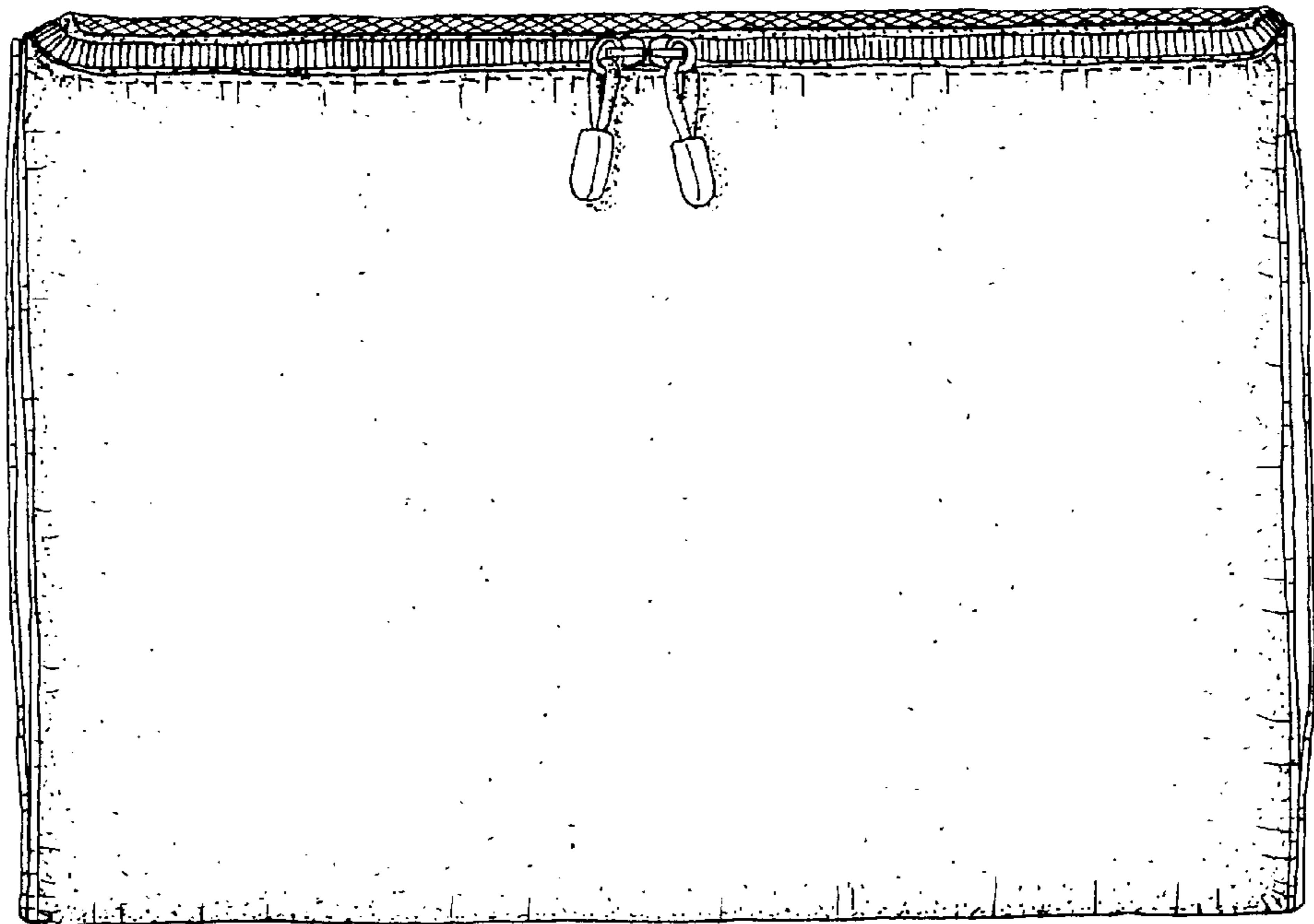

FIG. 3

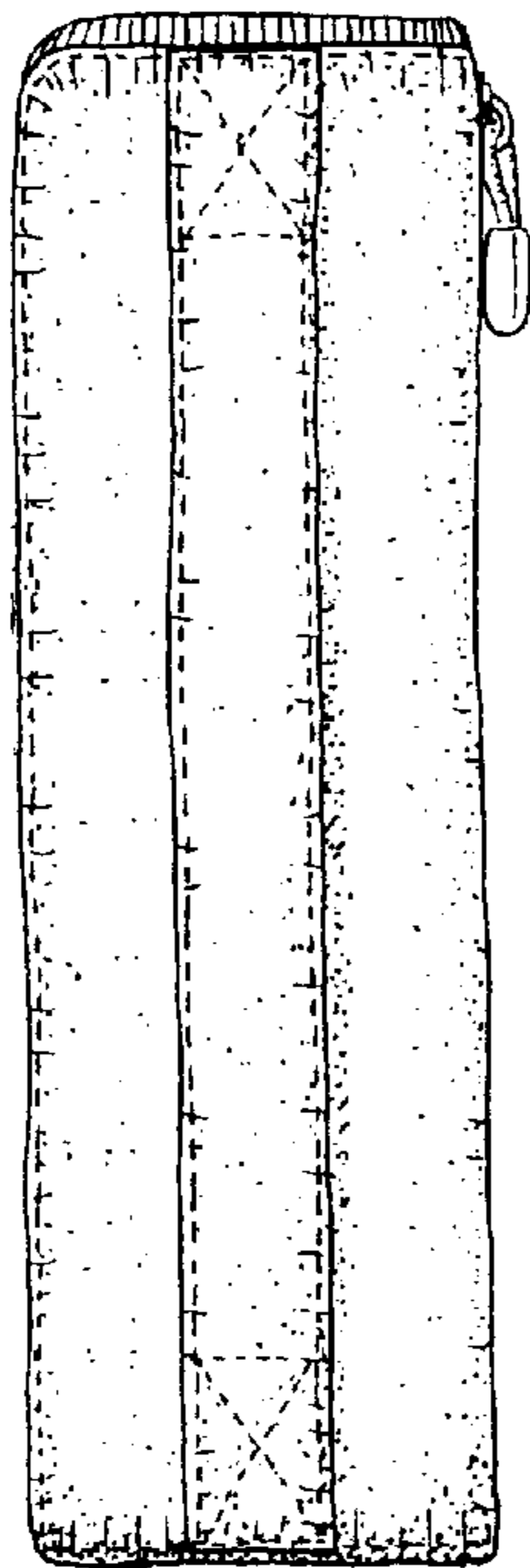

FIG. 4

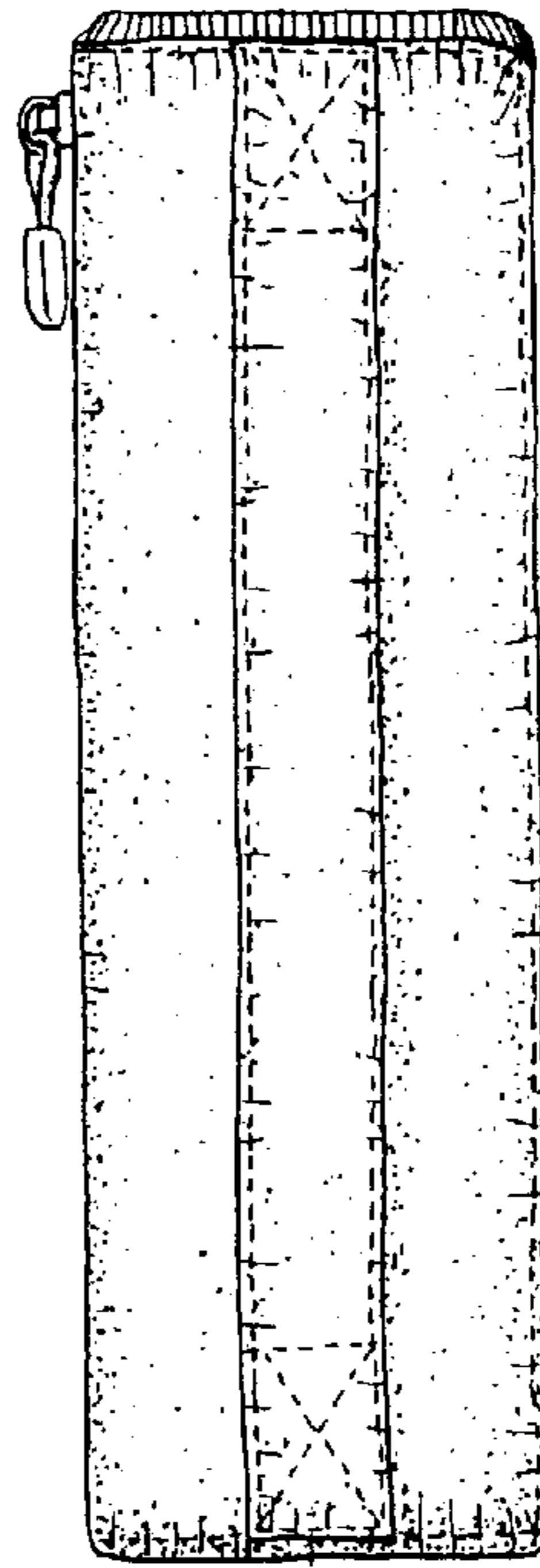

FIG. 5

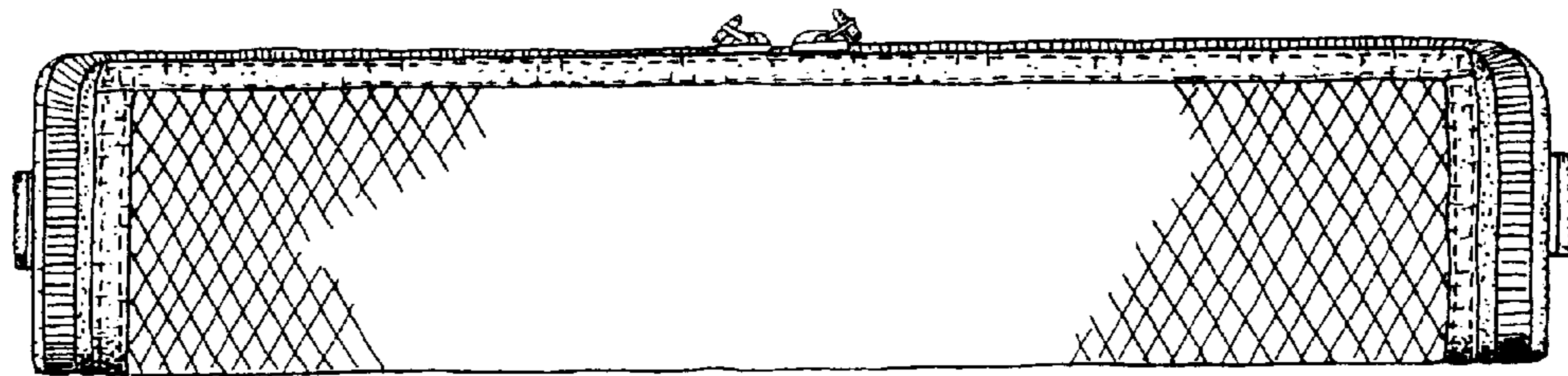

FIG. 6

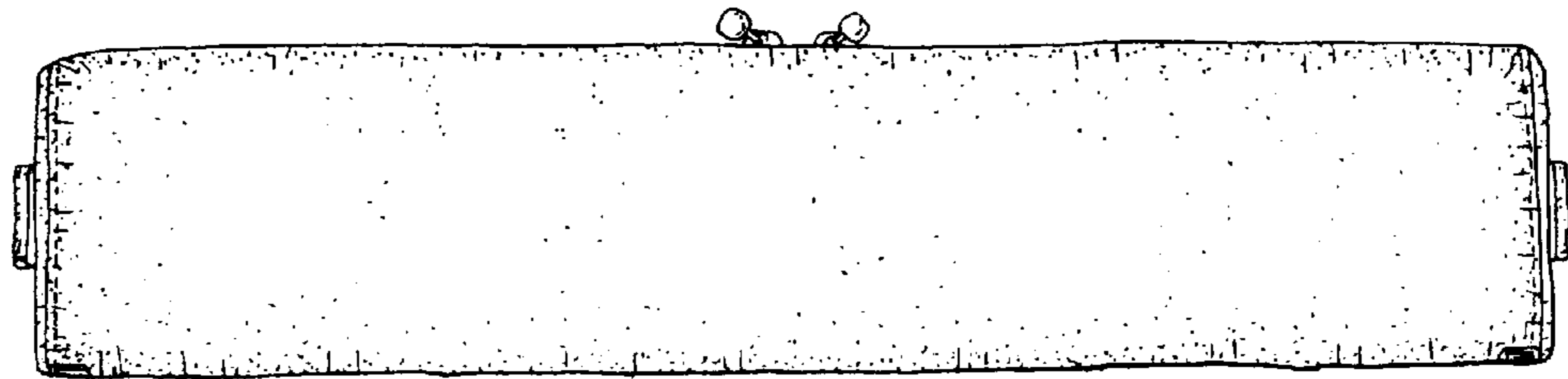

FIG. 7

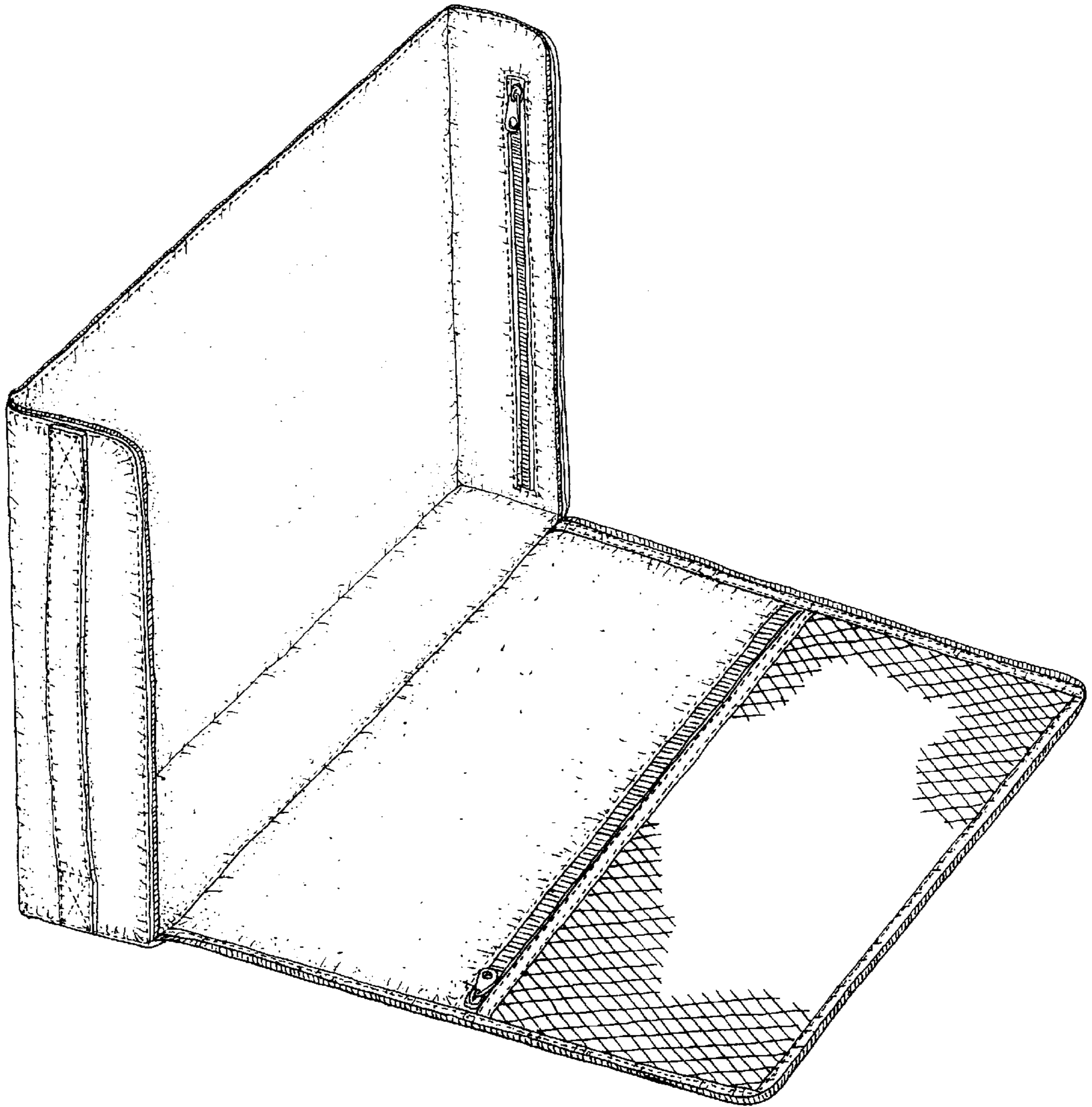

FIG. 8