



US00D481158S

(12) **United States Design Patent**
Cline

(10) **Patent No.:** **US D481,158 S**

(45) **Date of Patent:** **** Oct. 21, 2003**

(54) **LUMINAIRE BRACKET**

D421,663 S * 3/2000 Von Kluck D26/144
D445,940 S * 7/2001 Davis, Jr. D26/81

(75) Inventor: **Scott Michael Cline**, Blacklick, OH
(US)

* cited by examiner

(73) Assignee: **Acuity Brands, Inc.**, Atlanta, GA (US)

Primary Examiner—Pamela Burgess

(74) *Attorney, Agent, or Firm*—Kenneth E. Darnell

(**) Term: **14 Years**

(57) **CLAIM**

(21) Appl. No.: **29/169,363**

The ornamental design for a luminaire bracket, as shown and described.

(22) Filed: **Oct. 18, 2002**

DESCRIPTION

(51) **LOC (7) Cl.** **26-99**

(52) **U.S. Cl.** **D26/138; D26/144; D8/373**

(58) **Field of Search** D8/373; D6/556;
D26/72, 80-90, 138, 144, 147, 149, 142,
143; 362/147, 404-409; 248/317-318, 343,
342, 906, 344

FIG. 1 is a bottom perspective view of a luminaire bracket showing my new design;

FIG. 2 is a top perspective view thereof;

FIG. 3 is a first side elevational view thereof;

FIG. 4 is a second side elevational view seen rotated 45° from the first elevational view of FIG. 3;

FIG. 5 is a top plan view thereof; and,

FIG. 6 is a bottom view thereof;

The broken lines shown in the drawings are for illustrative purposes only and form no part of the claimed design.

(56) **References Cited**

U.S. PATENT DOCUMENTS

D70,159 S * 5/1926 Crumley D26/144
D311,679 S * 10/1990 Morris D8/373
D391,011 S * 2/1998 Kluck D26/142

1 Claim, 4 Drawing Sheets

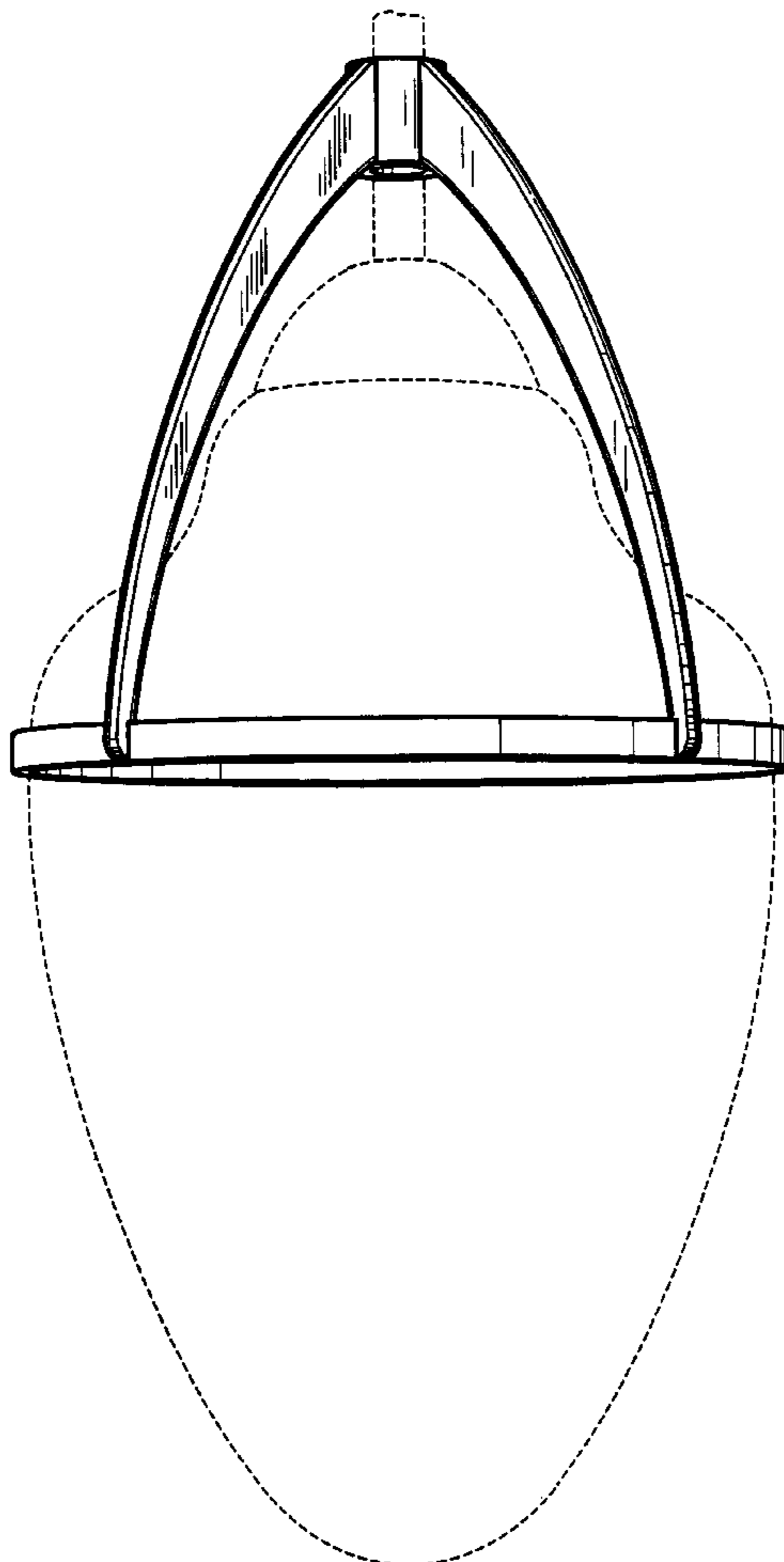

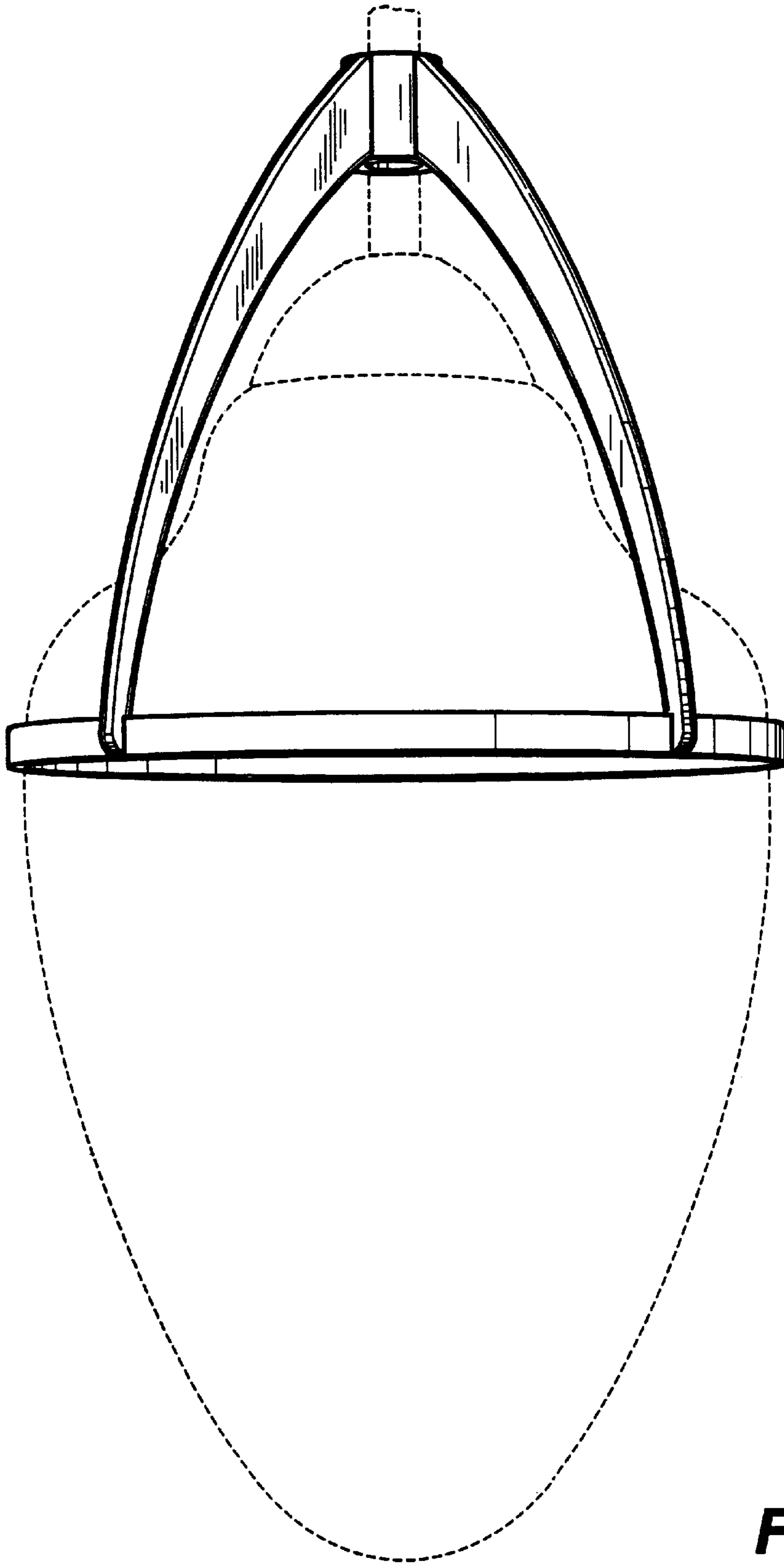

Fig. 1

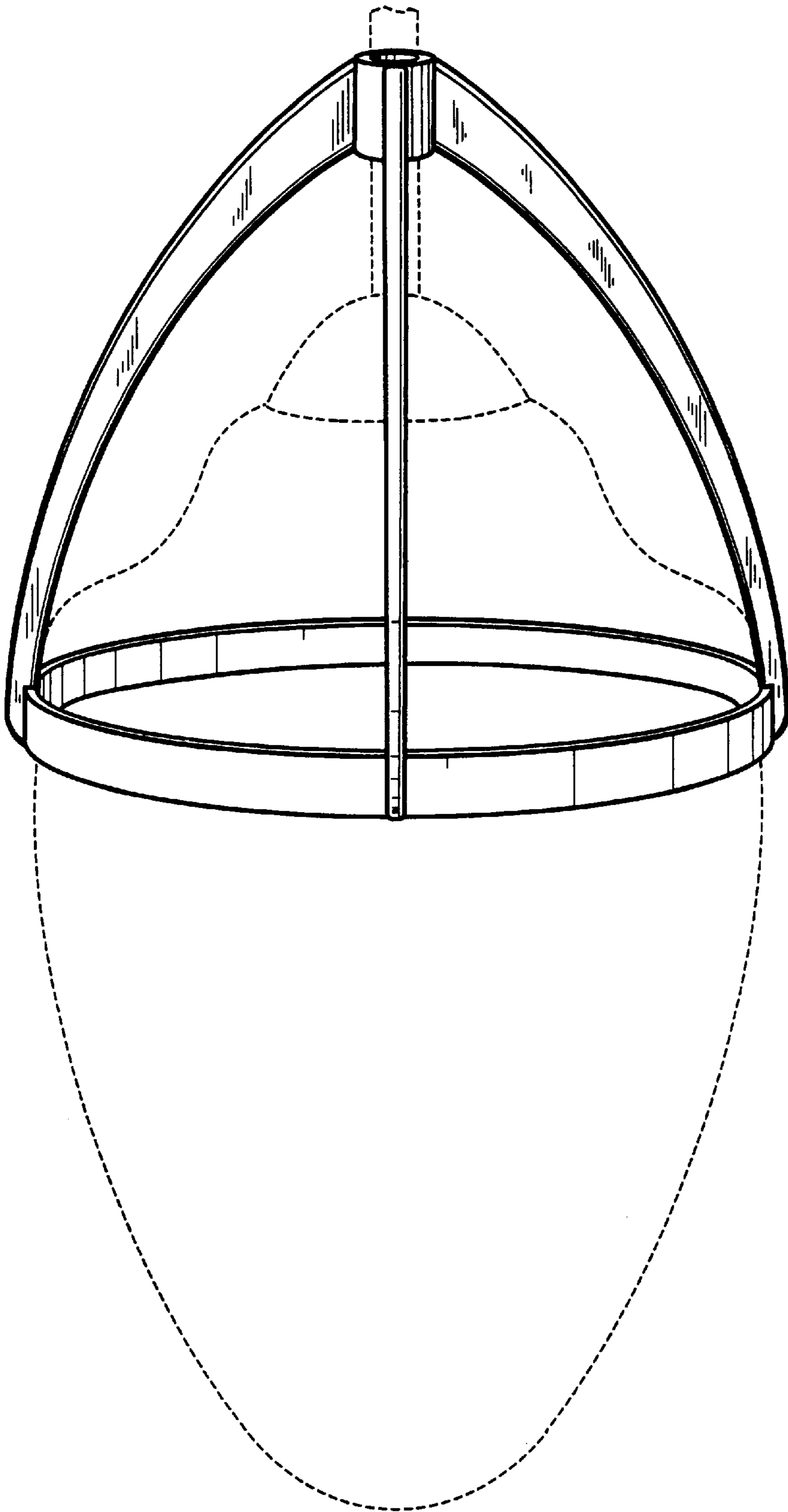

Fig. 2

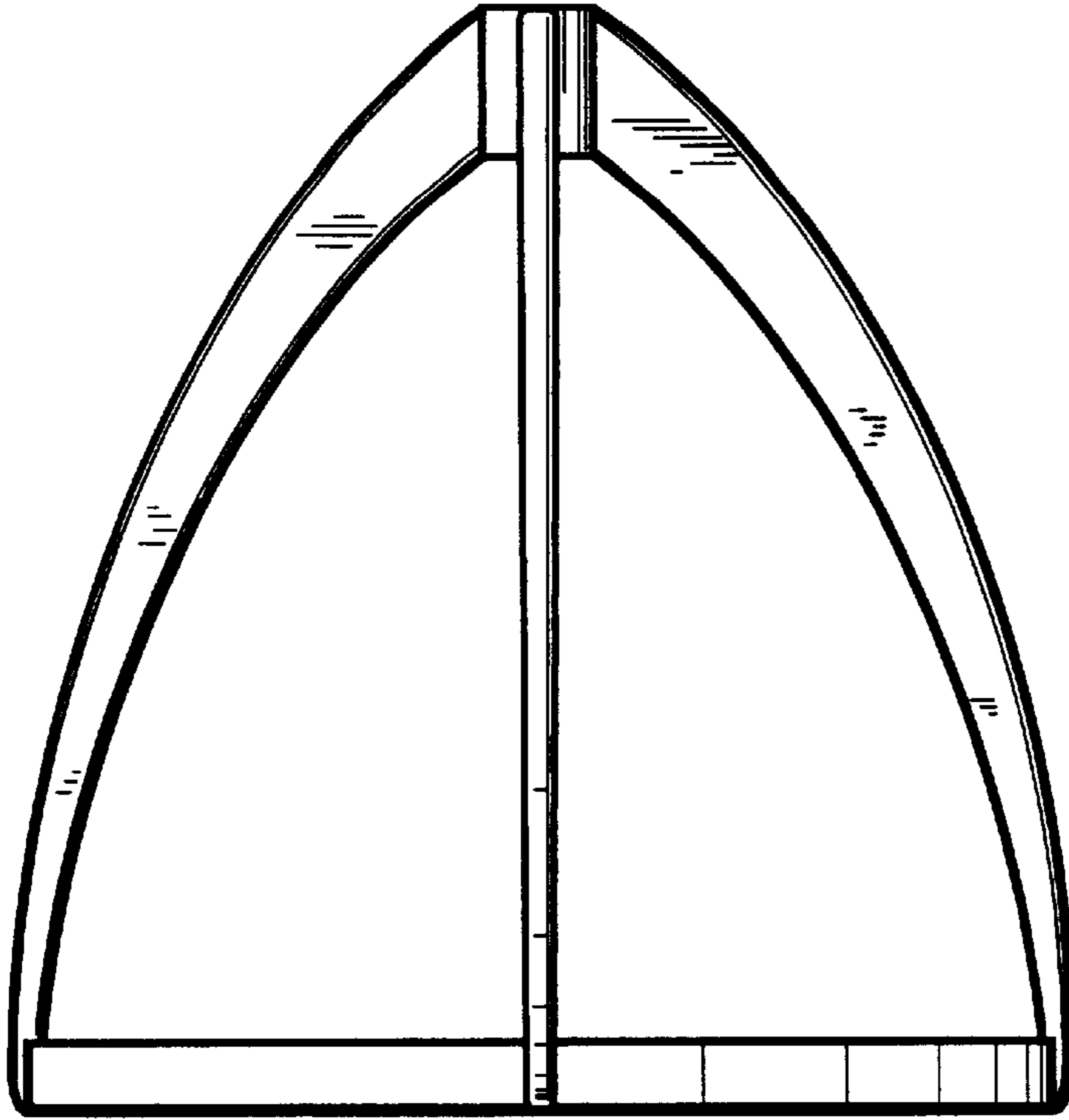

Fig. 3

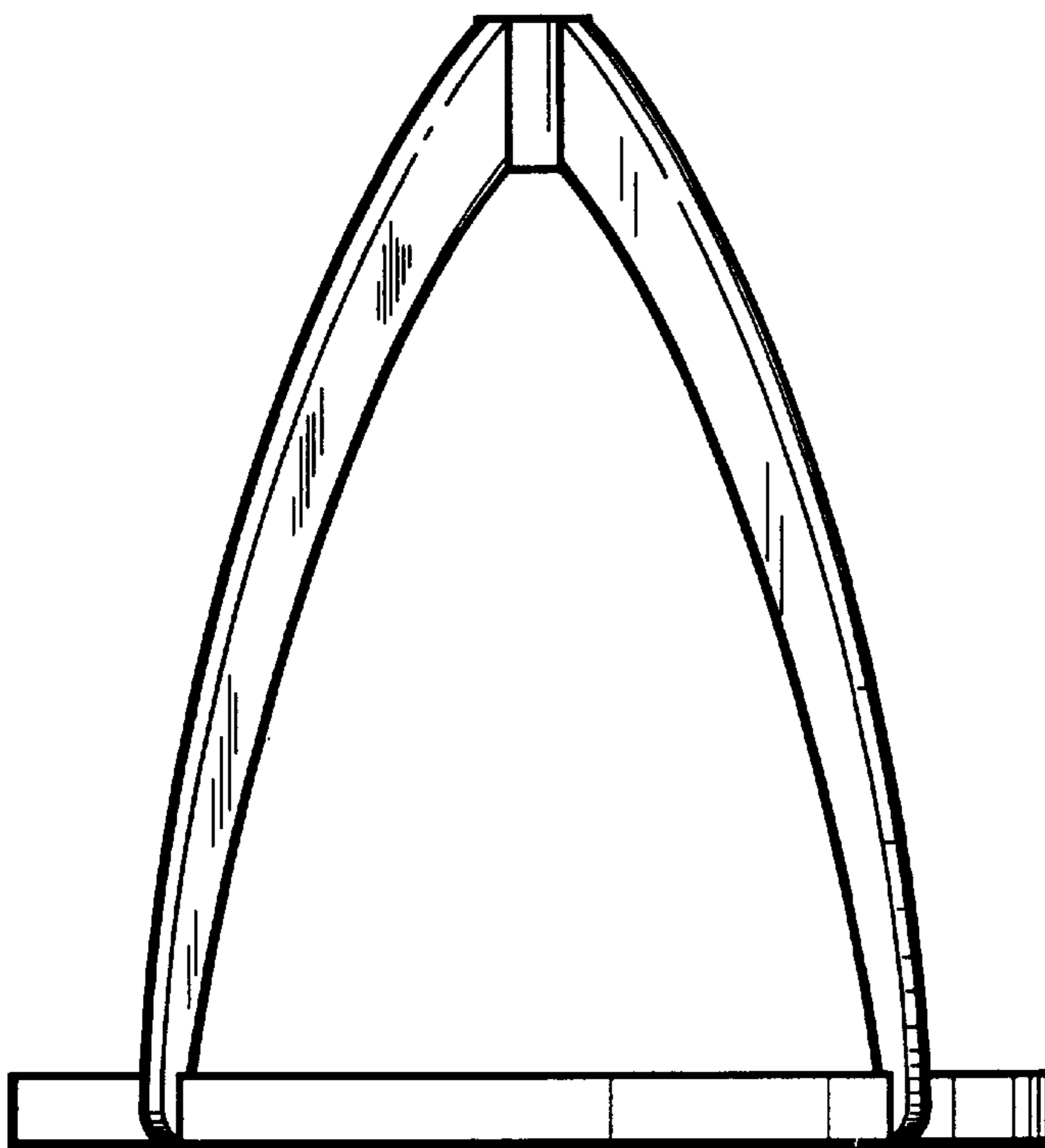

Fig. 4

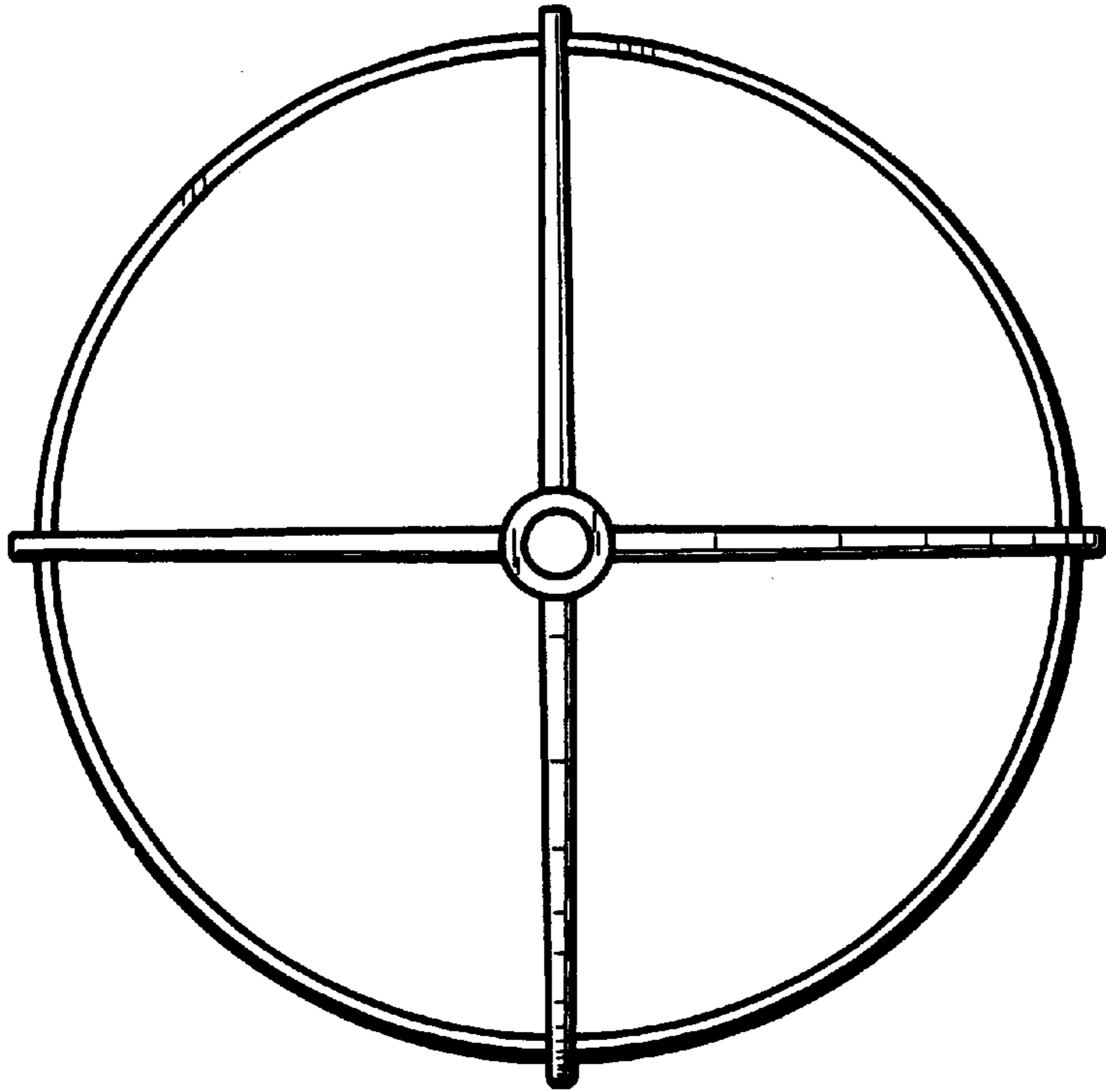

Fig. 5

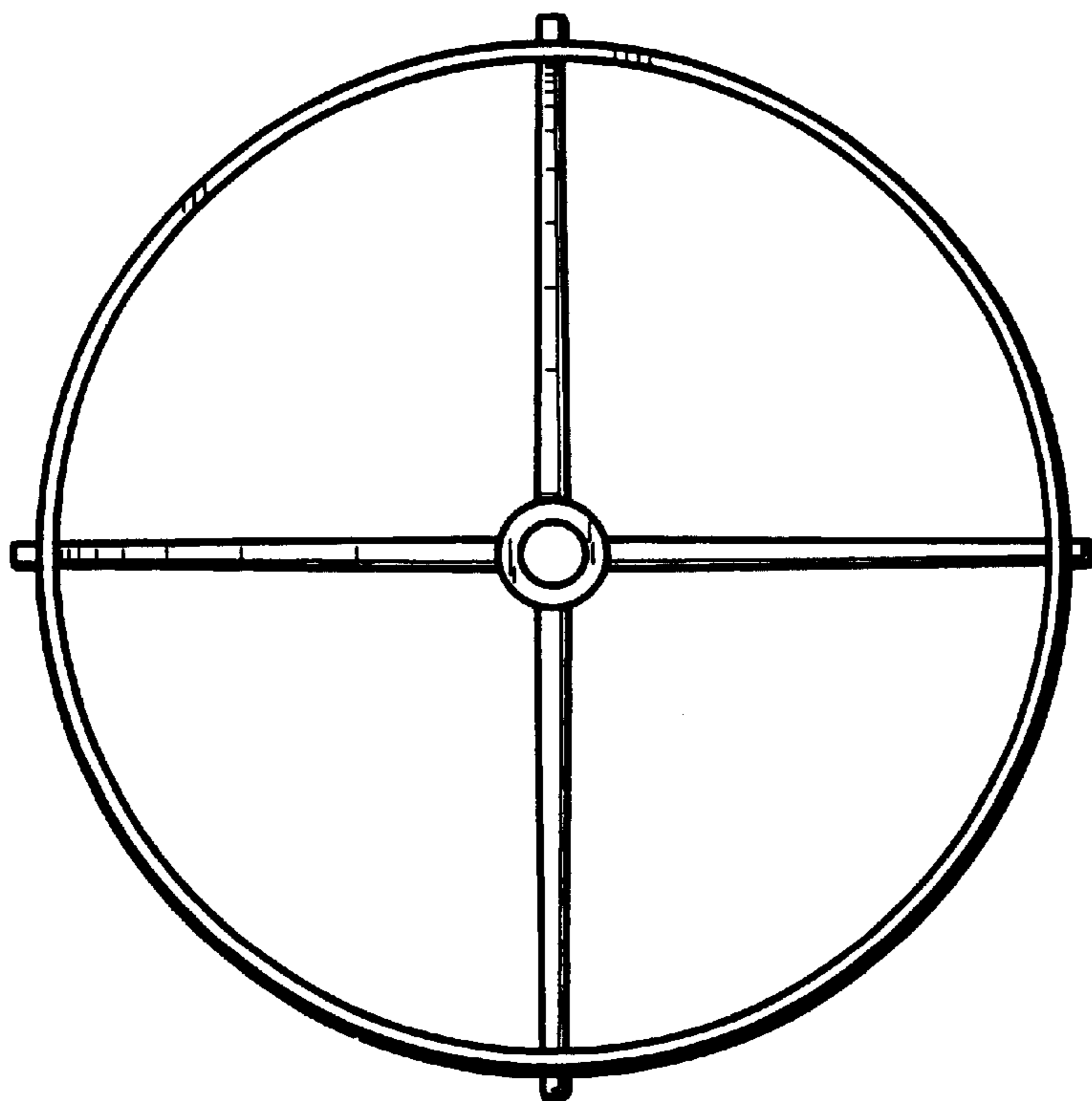

Fig. 6