



US00D481146S

(12) **United States Design Patent**  
**Yuen**

(10) **Patent No.:** **US D481,146 S**

(45) **Date of Patent:** **\*\* Oct. 21, 2003**

(54) **WATERPROOF RECHARGEABLE SEARCHLIGHT**

(75) Inventor: **John Se Kit Yuen, Kowloon (CN)**

(73) Assignee: **John Manufacturing Limited, Kowloon (CN)**

(\*\*) Term: **14 Years**

(21) Appl. No.: **29/170,583**

(22) Filed: **Nov. 8, 2002**

(30) **Foreign Application Priority Data**

Jul. 22, 2002 (CN) ..... 02 3 31730

(51) **LOC (7) Cl.** ..... **26-02**

(52) **U.S. Cl.** ..... **D26/37**

(58) **Field of Search** ..... D26/37-50; 362/109, 362/157, 158, 171, 172, 173, 183-208

(56) **References Cited**

**U.S. PATENT DOCUMENTS**

D256,285 S	*	8/1980	Wong	.....	D26/42
D278,366 S	*	4/1985	Ohashi	.....	D26/42
D368,784 S	*	4/1996	Yuen	.....	D26/37

\* cited by examiner

*Primary Examiner*—Marcus A. Jackson  
(74) *Attorney, Agent, or Firm*—Alix, Yale & Ristas, LLP

(57) **CLAIM**

The ornamental design for a waterproof rechargeable searchlight, as shown and described.

**DESCRIPTION**

FIG. 1 is a front view of the waterproof rechargeable searchlight showing my new design;

FIG. 2 is a rear view of the waterproof rechargeable searchlight of FIG. 1;

FIG. 3 is a top plan view of the waterproof rechargeable searchlight of FIG. 1;

FIG. 4 is a bottom plan view of the waterproof rechargeable searchlight of FIG. 1;

FIG. 5 is a right side view of the waterproof rechargeable searchlight of FIG. 1;

FIG. 6 is a left side view of the waterproof rechargeable searchlight of FIG. 1; and,

FIG. 7 is a right side view of the waterproof rechargeable searchlight of FIG. 1 illustrating a lamp portion in a second rotated position.

**1 Claim, 3 Drawing Sheets**

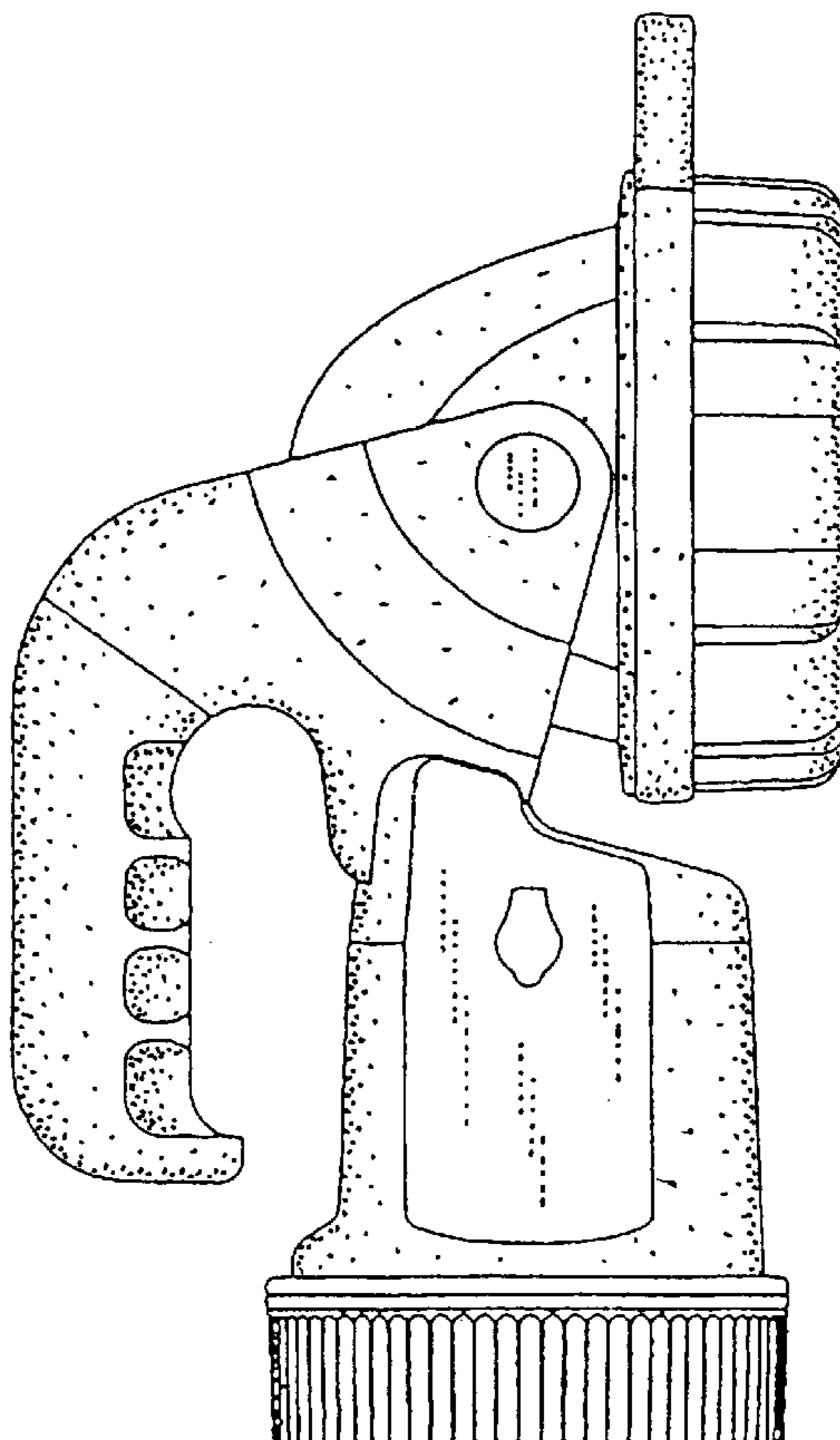
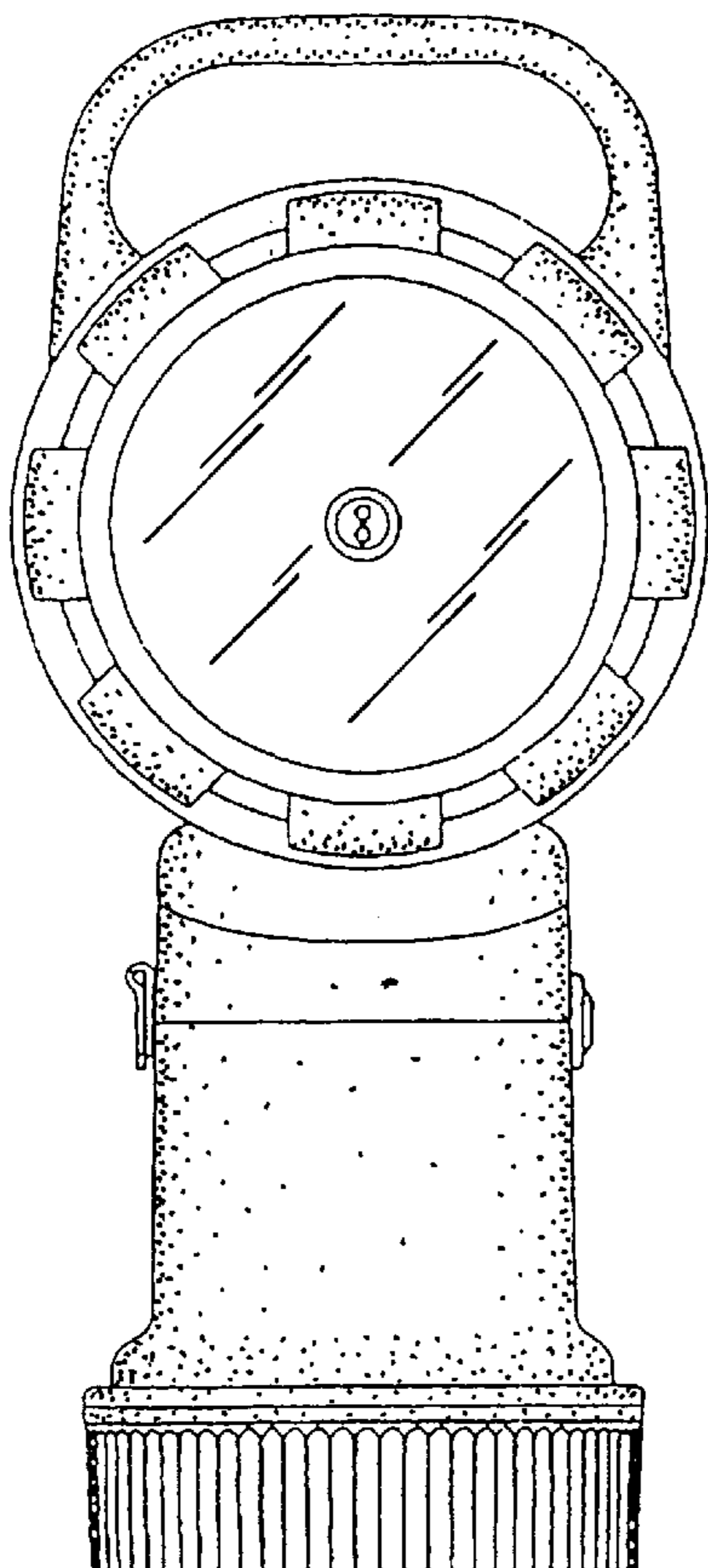

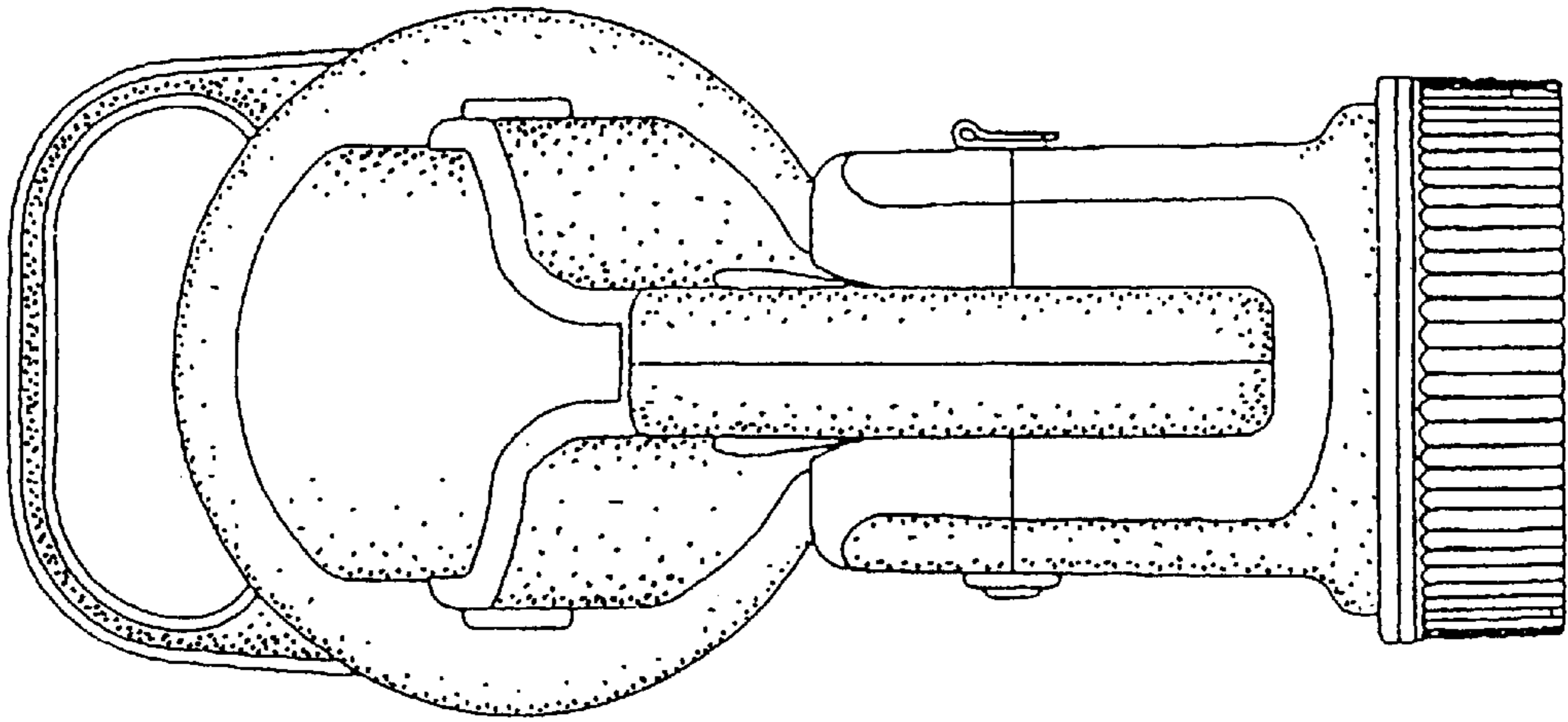

Figure 2

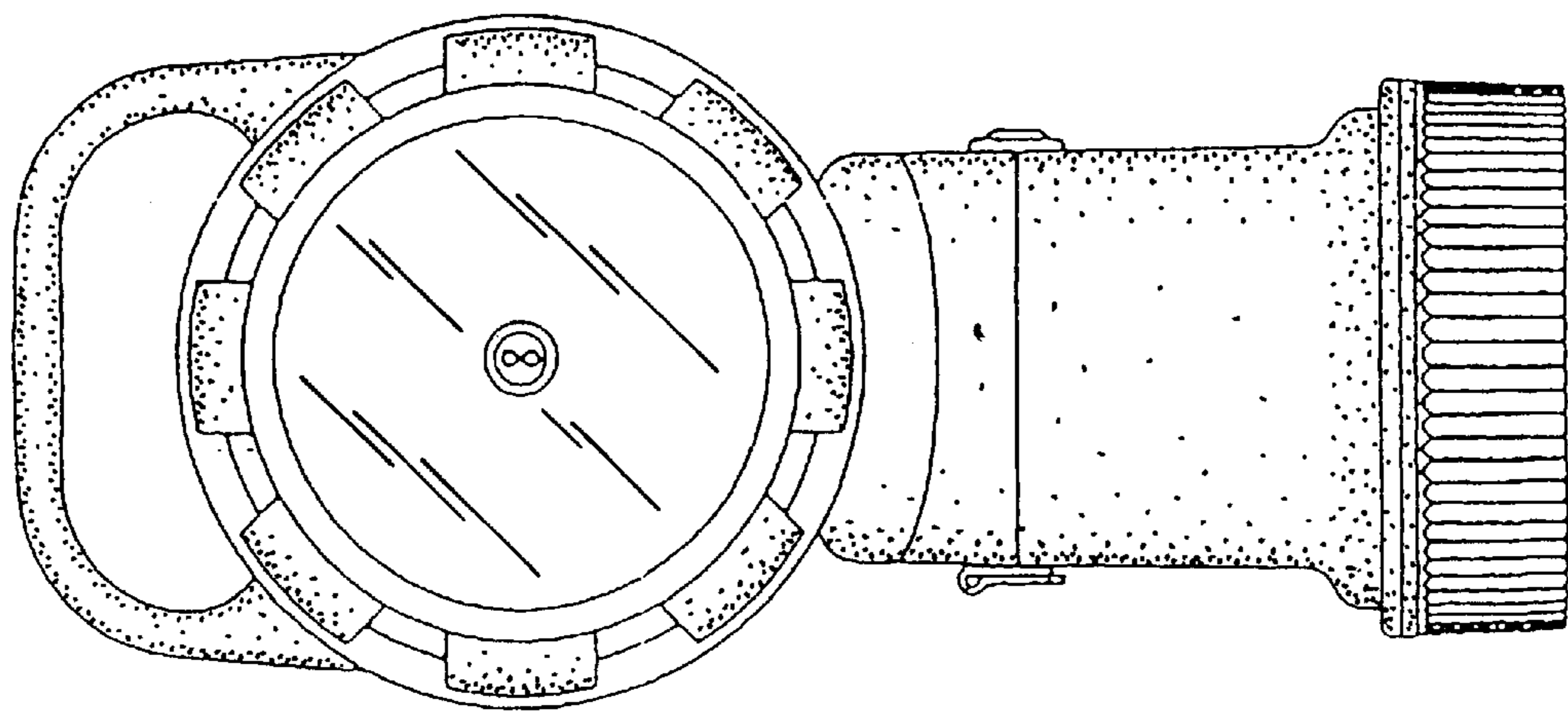

Figure 1

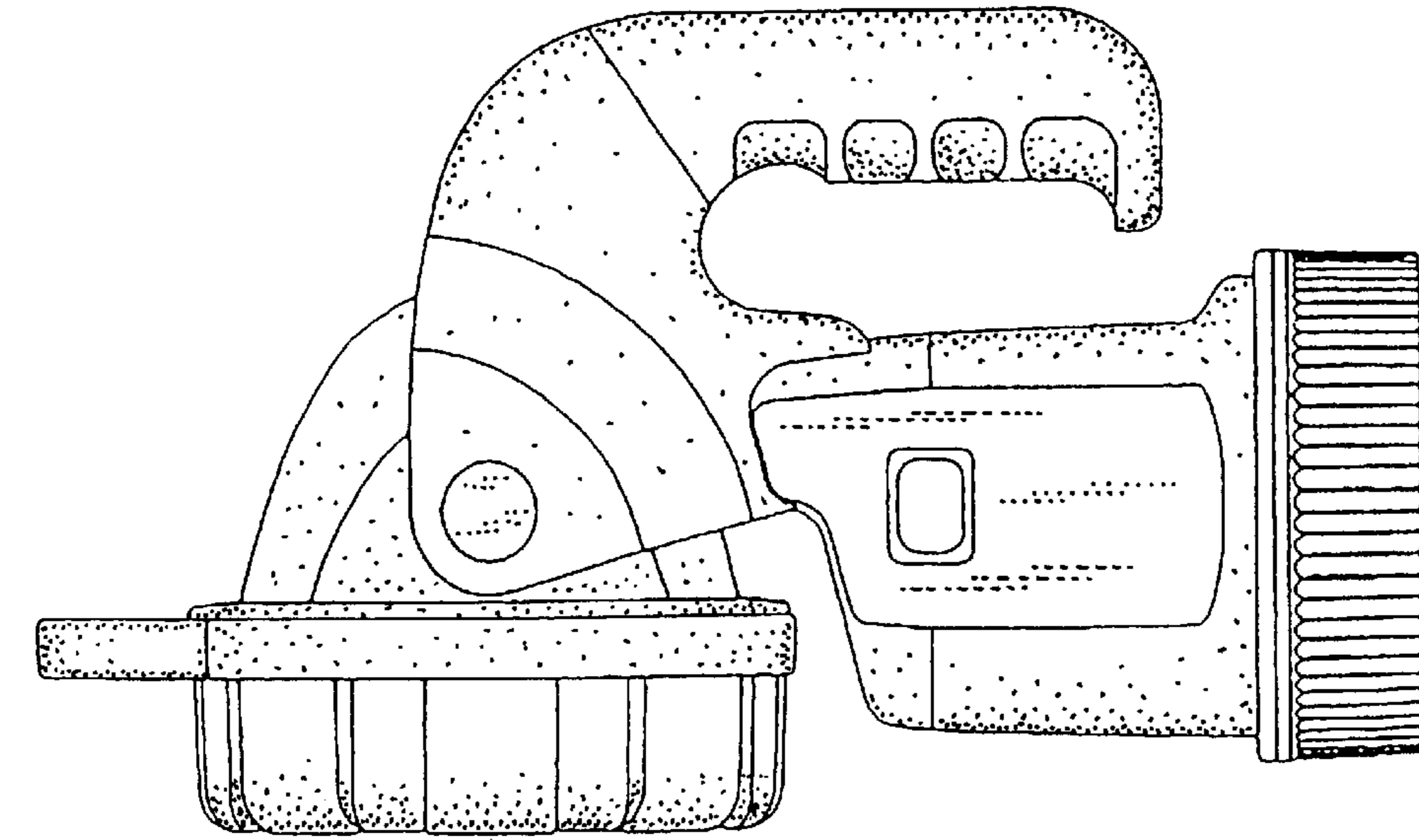

Figure 5

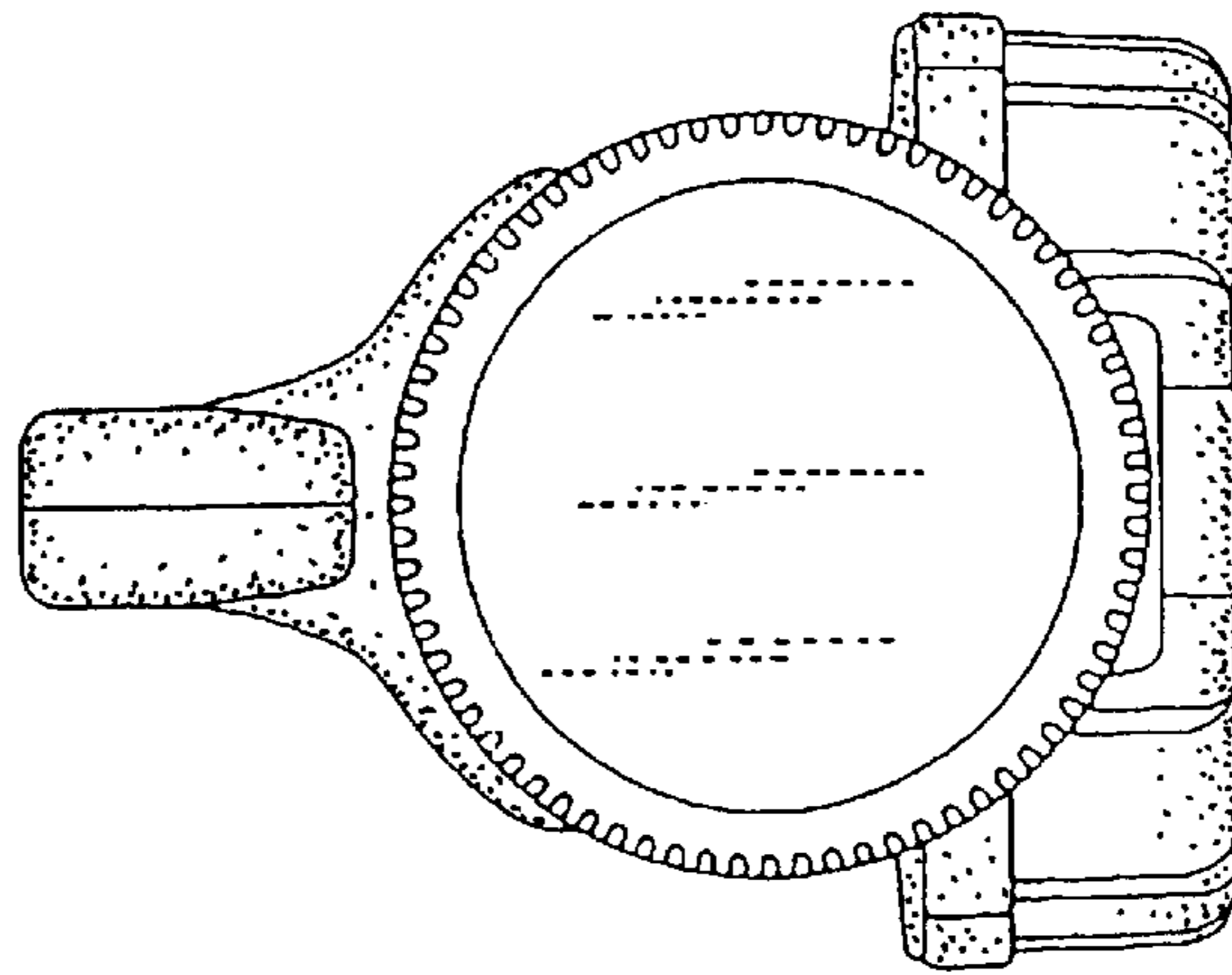

Figure 4

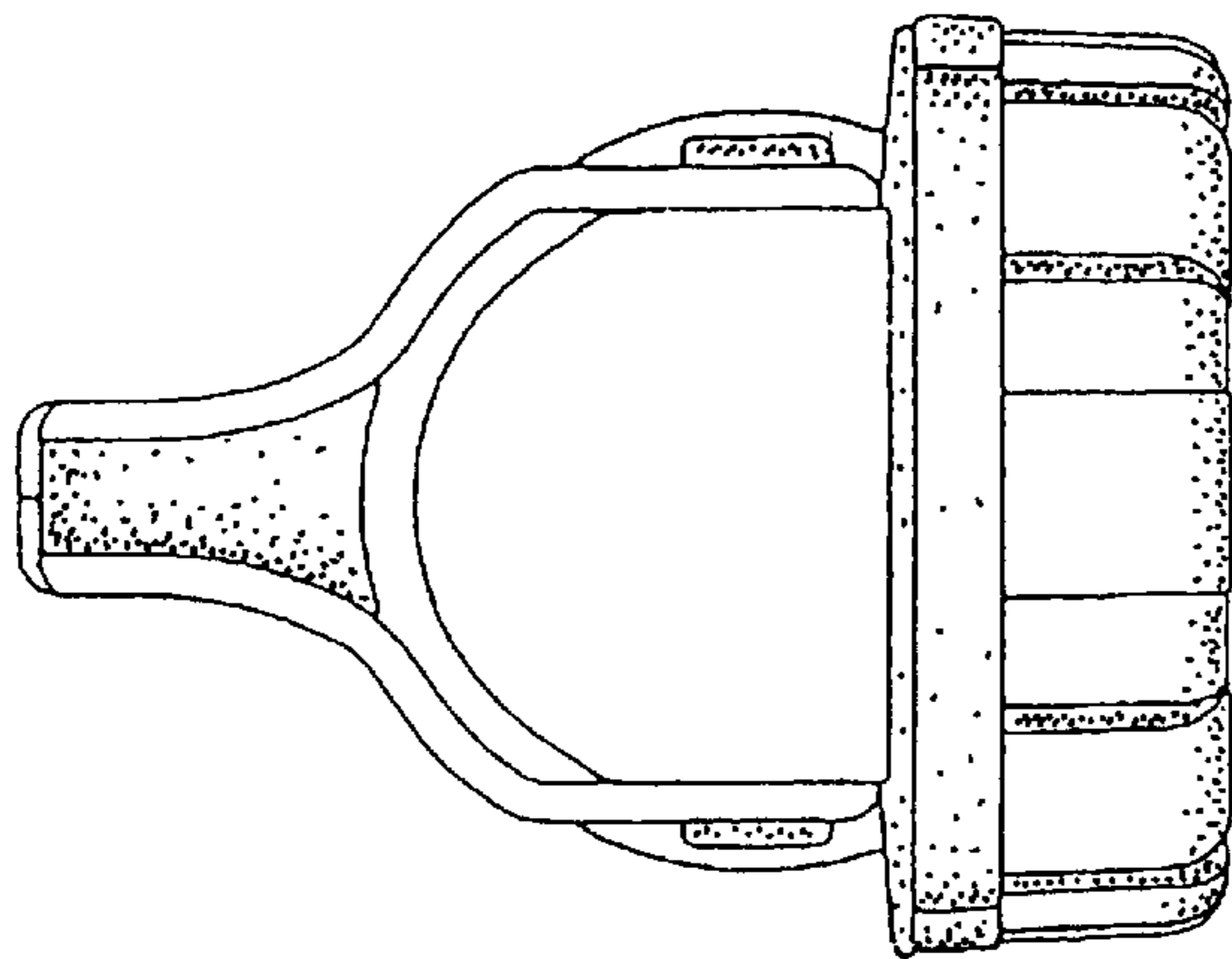

Figure 3

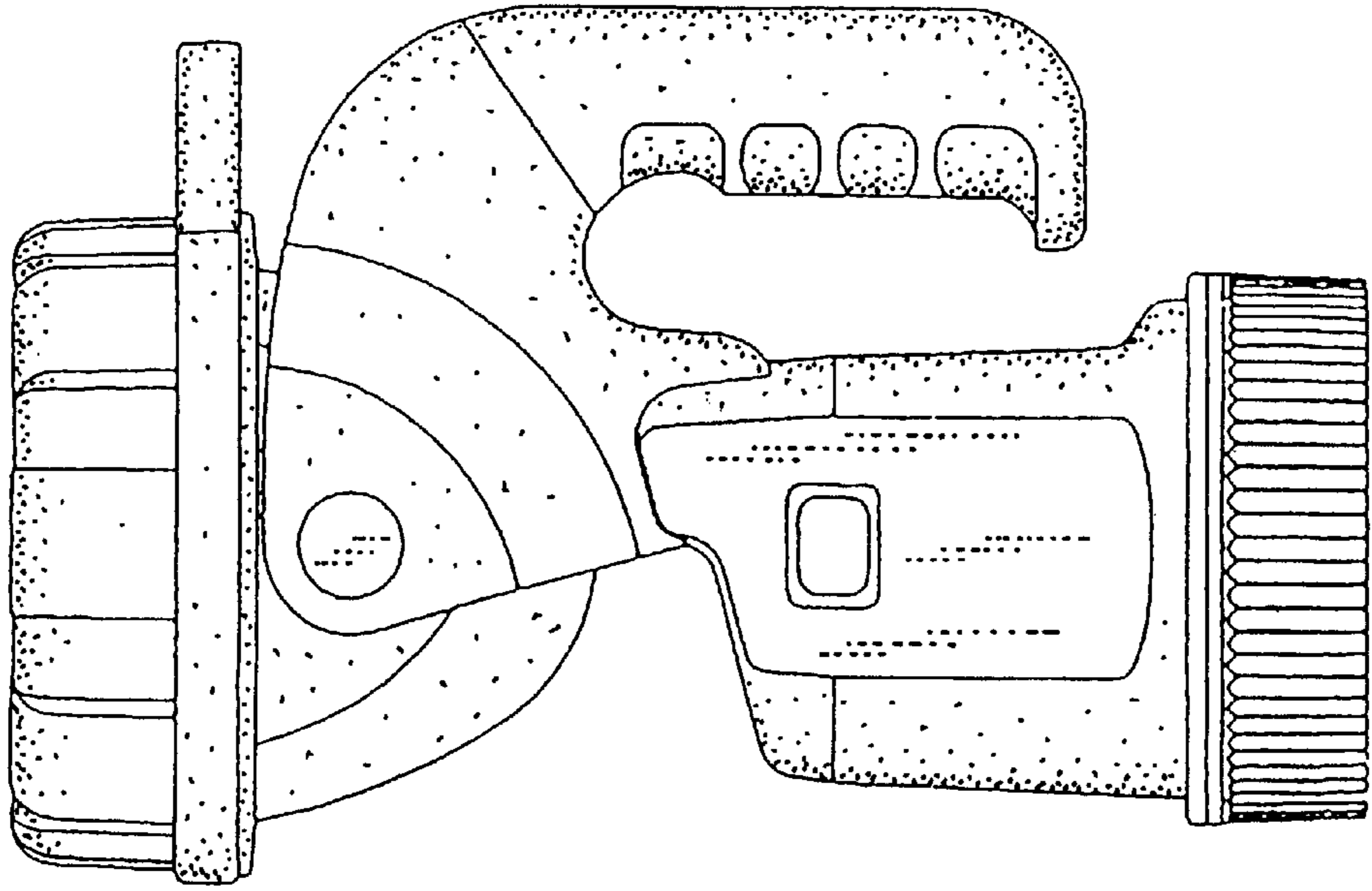

Figure 7

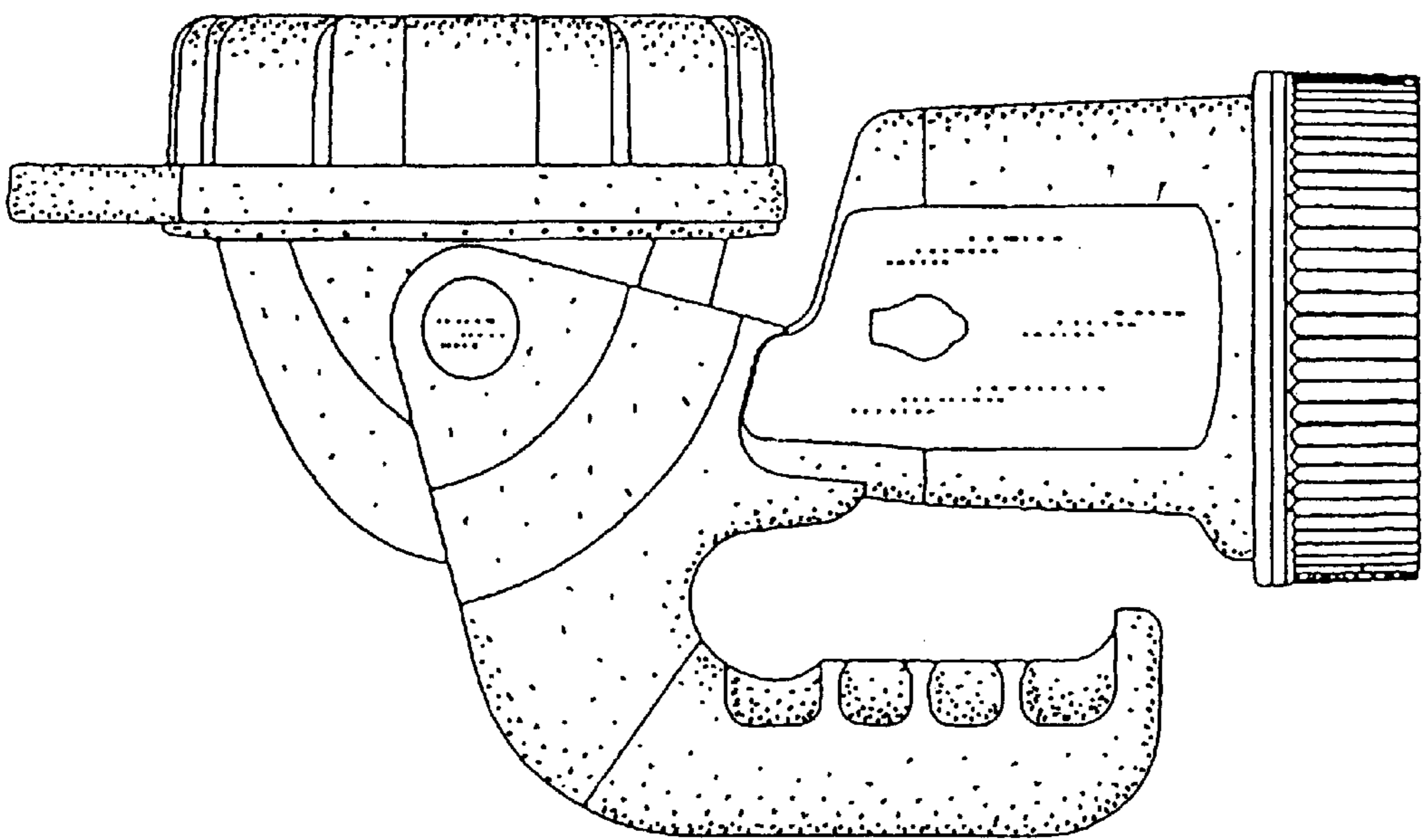

Figure 6