



US00D481112S

(12) **United States Design Patent**  
**Best et al.**

(10) **Patent No.: US D481,112 S**

(45) **Date of Patent: \*\* Oct. 21, 2003**

(54) **HUMIDIFIER**

(75) Inventors: **Jim Best**, Weehawken, NJ (US);  
**Timothy J Kennedy**, Staten Island, NY (US)

(73) Assignee: **Kaz, Inc.**, New York, NY (US)

(\*\*) Term: **14 Years**

(21) Appl. No.: **29/169,377**

(22) Filed: **Oct. 18, 2002**

(51) **LOC (7) Cl.** ..... **23-04**

(52) **U.S. Cl.** ..... **D23/356**

(58) **Field of Search** ..... D23/356, 359;  
422/120, 123; 392/394, 403, 405, 406

(56) **References Cited**

**U.S. PATENT DOCUMENTS**

D395,491 S	*	6/1998	Jane' et al.	.....	D23/356
D438,294 S	*	2/2001	Krauss et al.	.....	D23/356
D438,295 S	*	2/2001	Krauss	.....	D23/356
D438,296 S	*	2/2001	Krauss	.....	D23/356
D442,682 S	*	5/2001	Choi et al.	.....	D23/356
D454,189 S	*	3/2002	Rakocy	.....	D23/356

\* cited by examiner

*Primary Examiner*—Robin V. Taylor

(74) *Attorney, Agent, or Firm*—Darby & Darby P.C.

(57) **CLAIM**

The ornamental design for a humidifier, as shown and described.

**DESCRIPTION**

FIG. 1 is a top, rear perspective view showing a first embodiment of our new design;

FIG. 2 is a right side elevational view thereof;

FIG. 3 is a rear elevational view thereof;

FIG. 4 is a front elevational view thereof;

FIG. 5 is a left side elevational view thereof;

FIG. 6 is a top plan view thereof;

FIG. 7 is a bottom plan view thereof;

FIG. 8 is a top, rear perspective view showing a second embodiment of our new design;

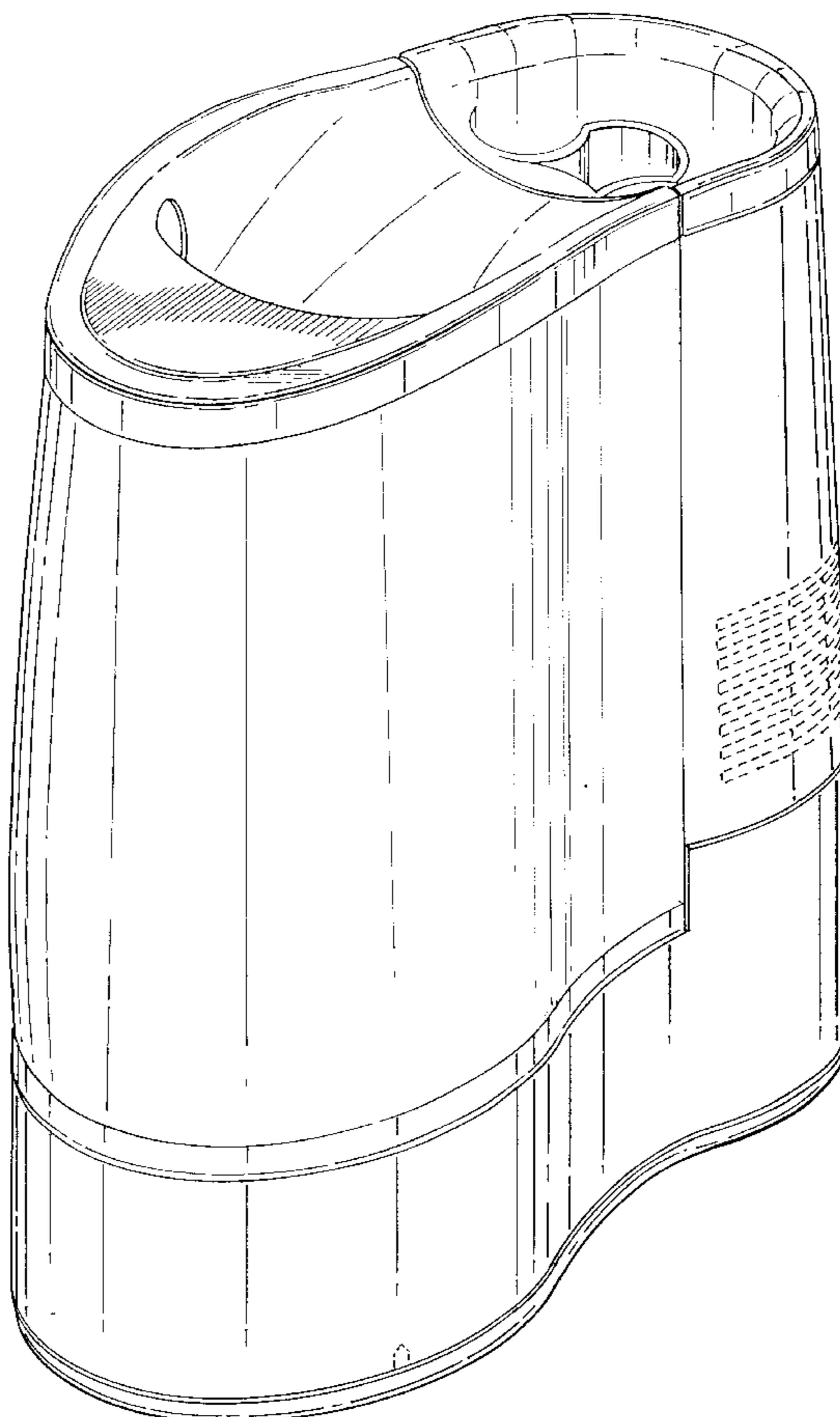
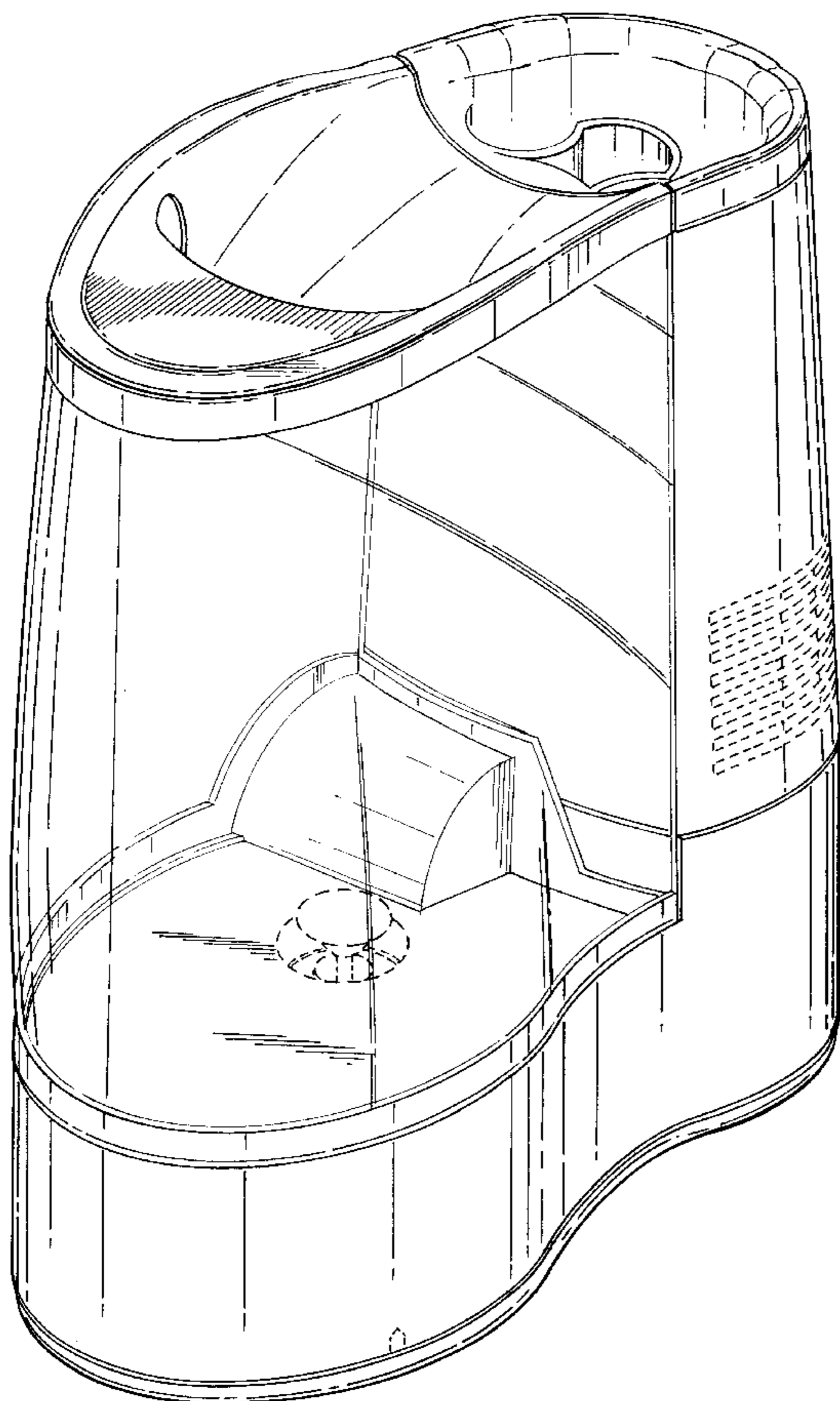
FIG. 9 is a right side elevational view thereof;

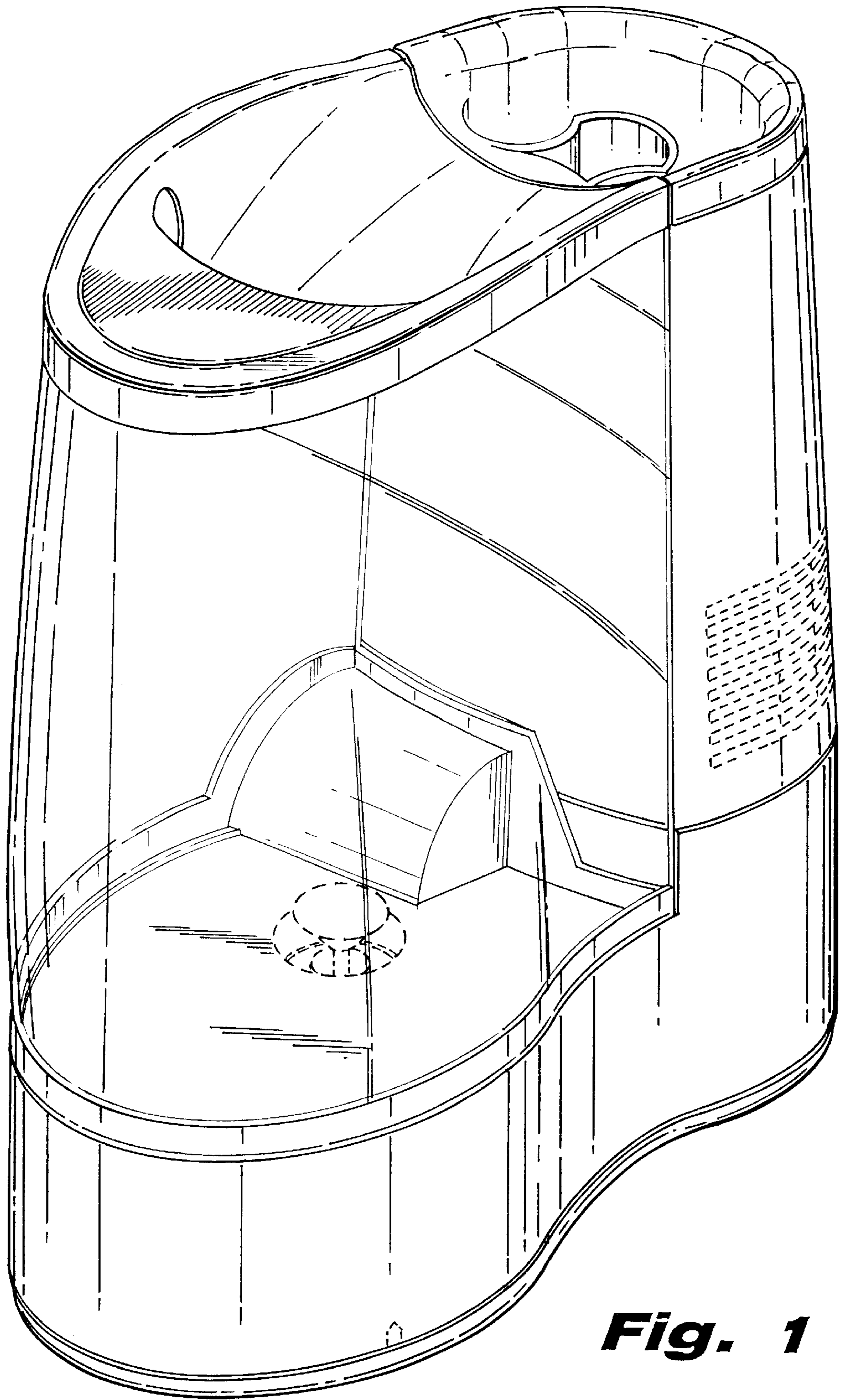
FIG. 10 is a rear elevational view thereof; and,

FIG. 11 is a front elevational view thereof.

The broken line showing is for illustrative purposes only and forms no part of the claimed design.

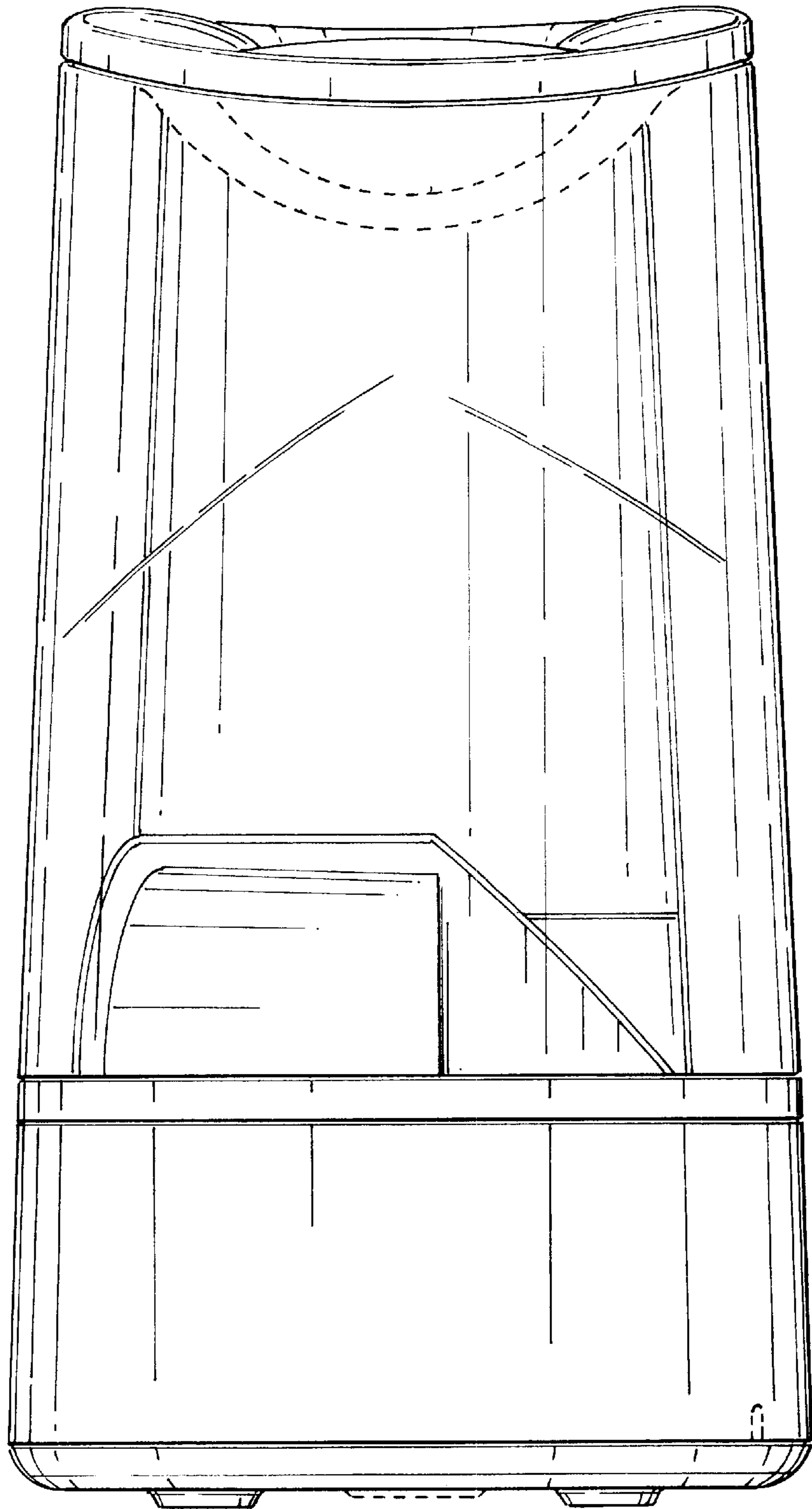
**1 Claim, 10 Drawing Sheets**



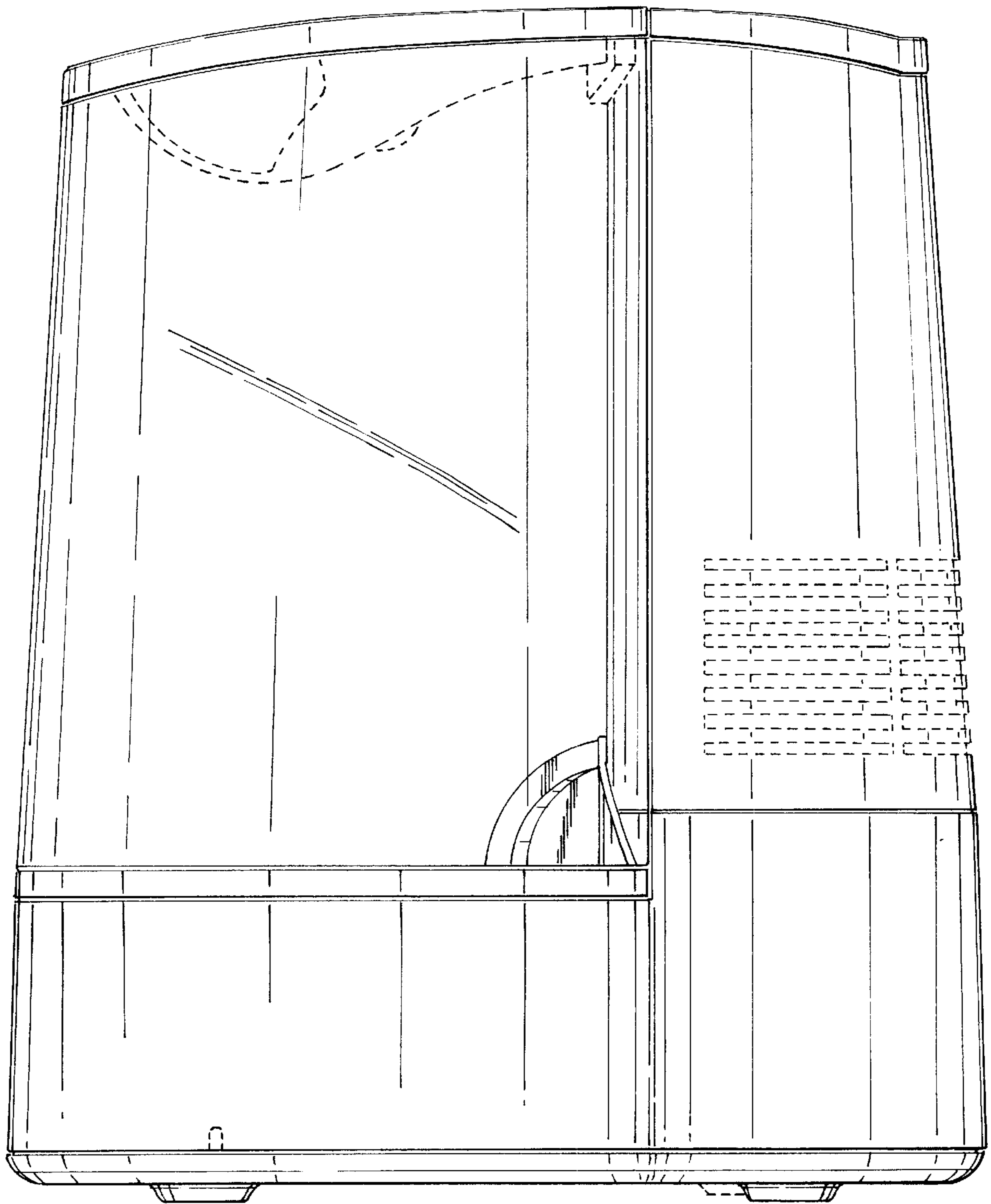


**Fig. 1**

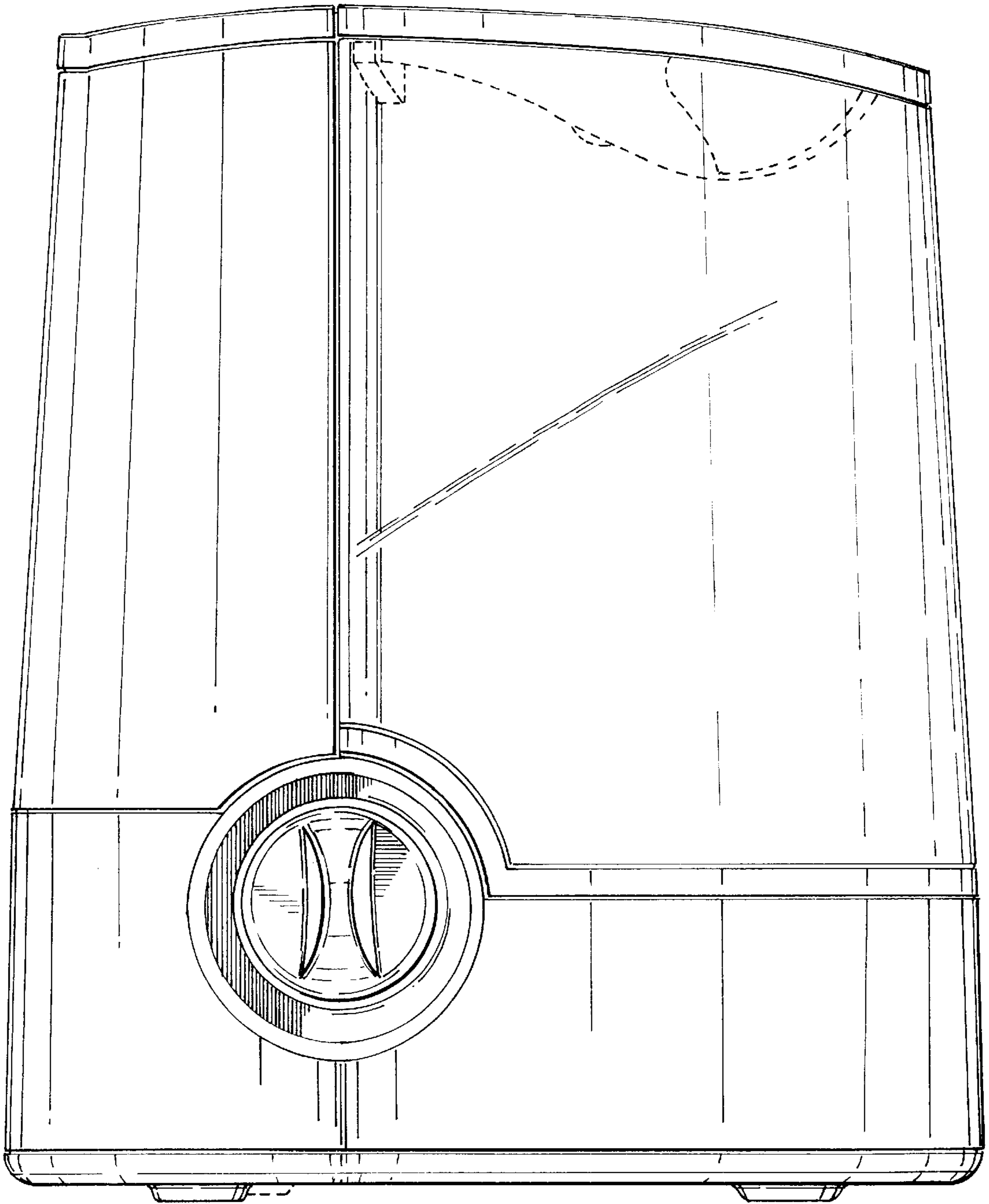
***Fig. 2***





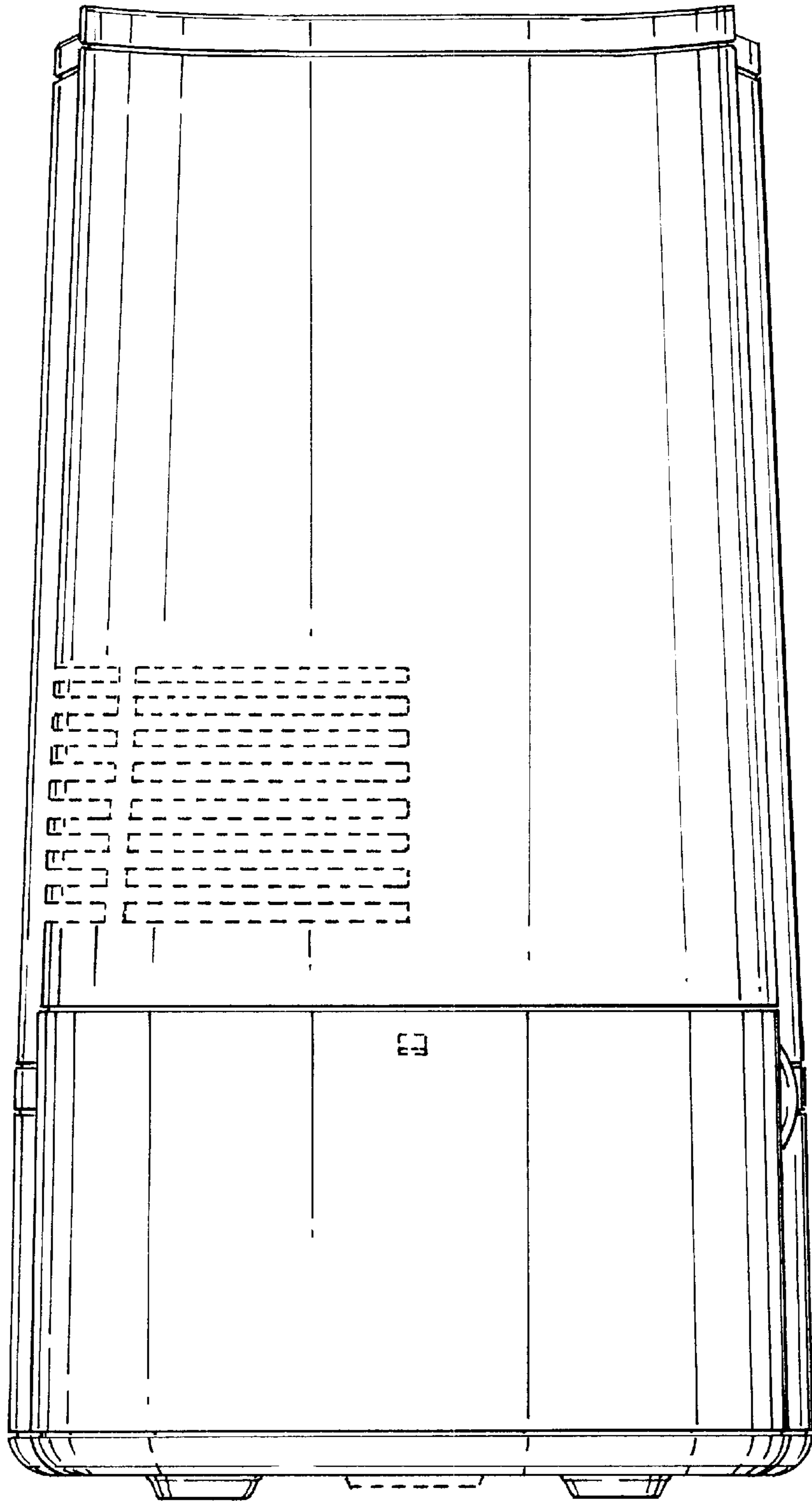


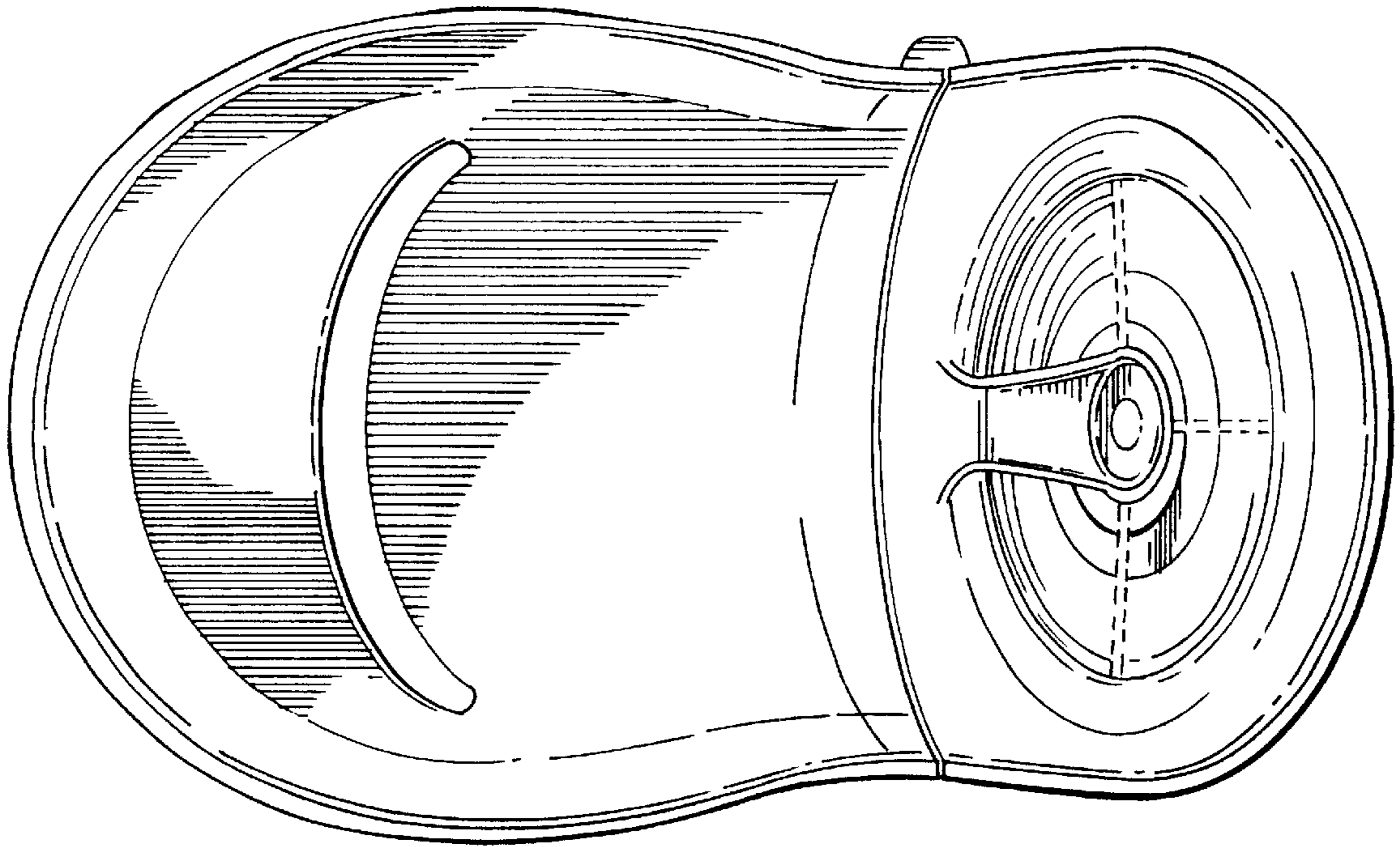
**Fig. 3**



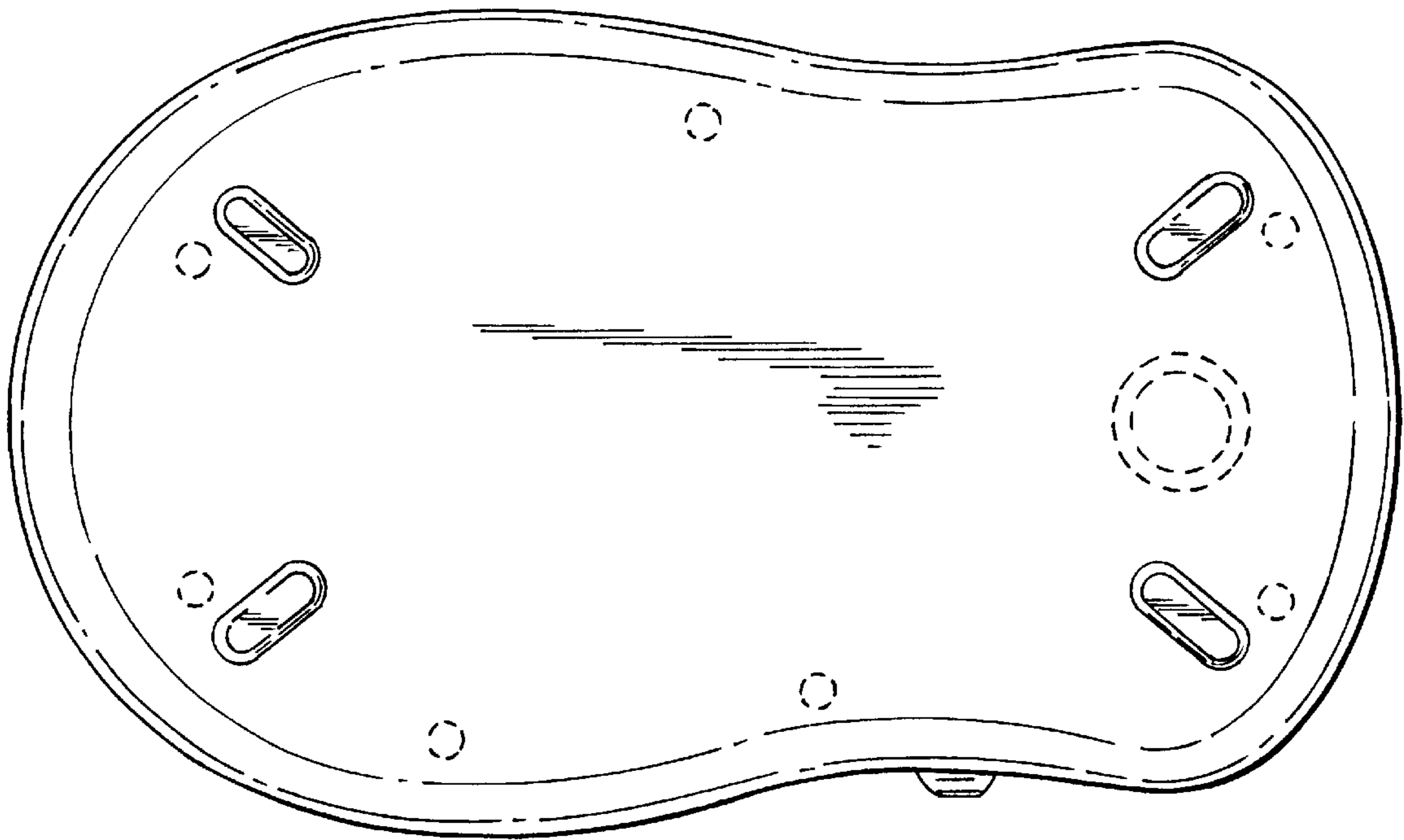
**Fig. 4**

**Fig. 5**

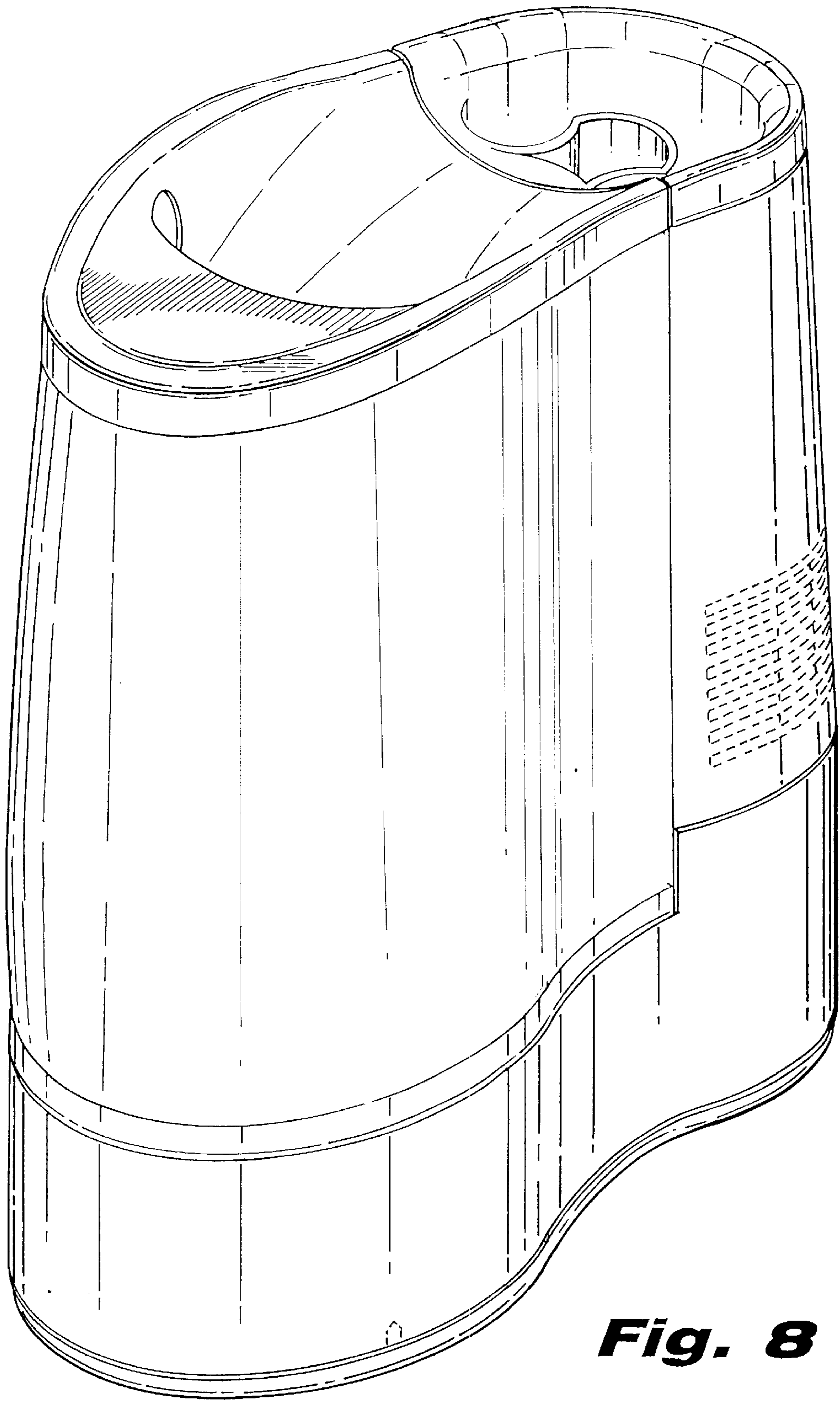




**Fig. 6**



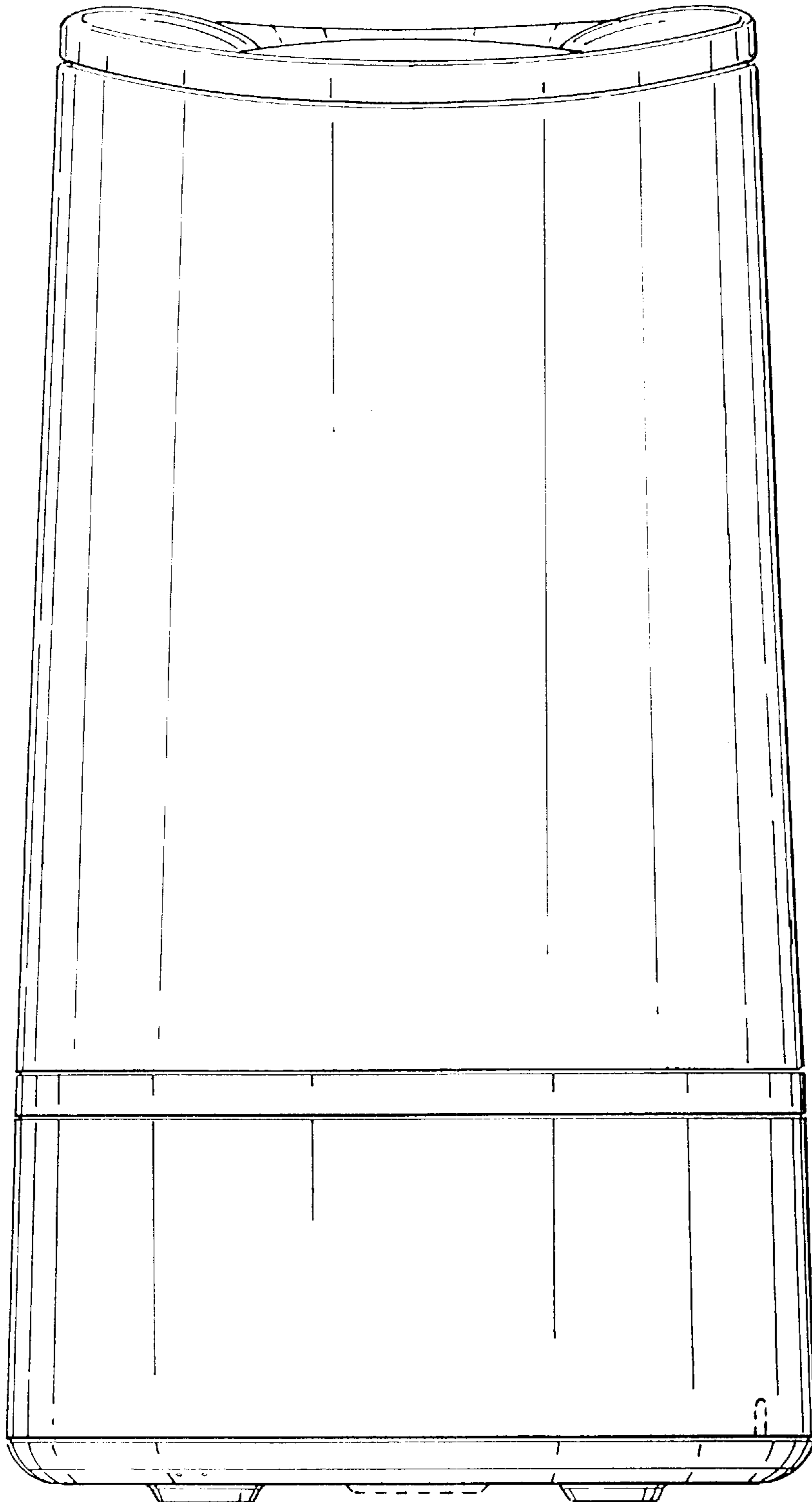
**Fig. 7**

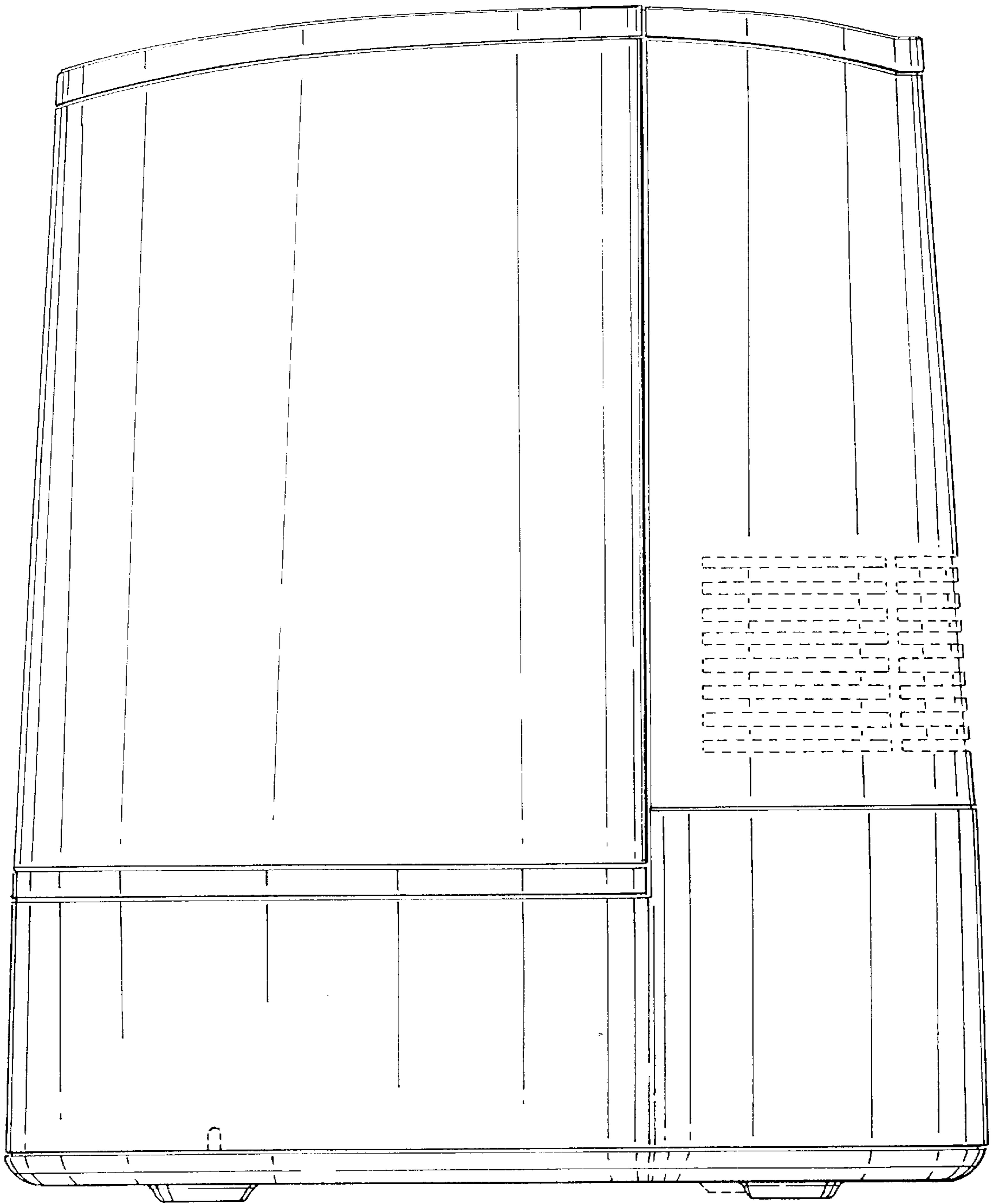


**Fig. 8**

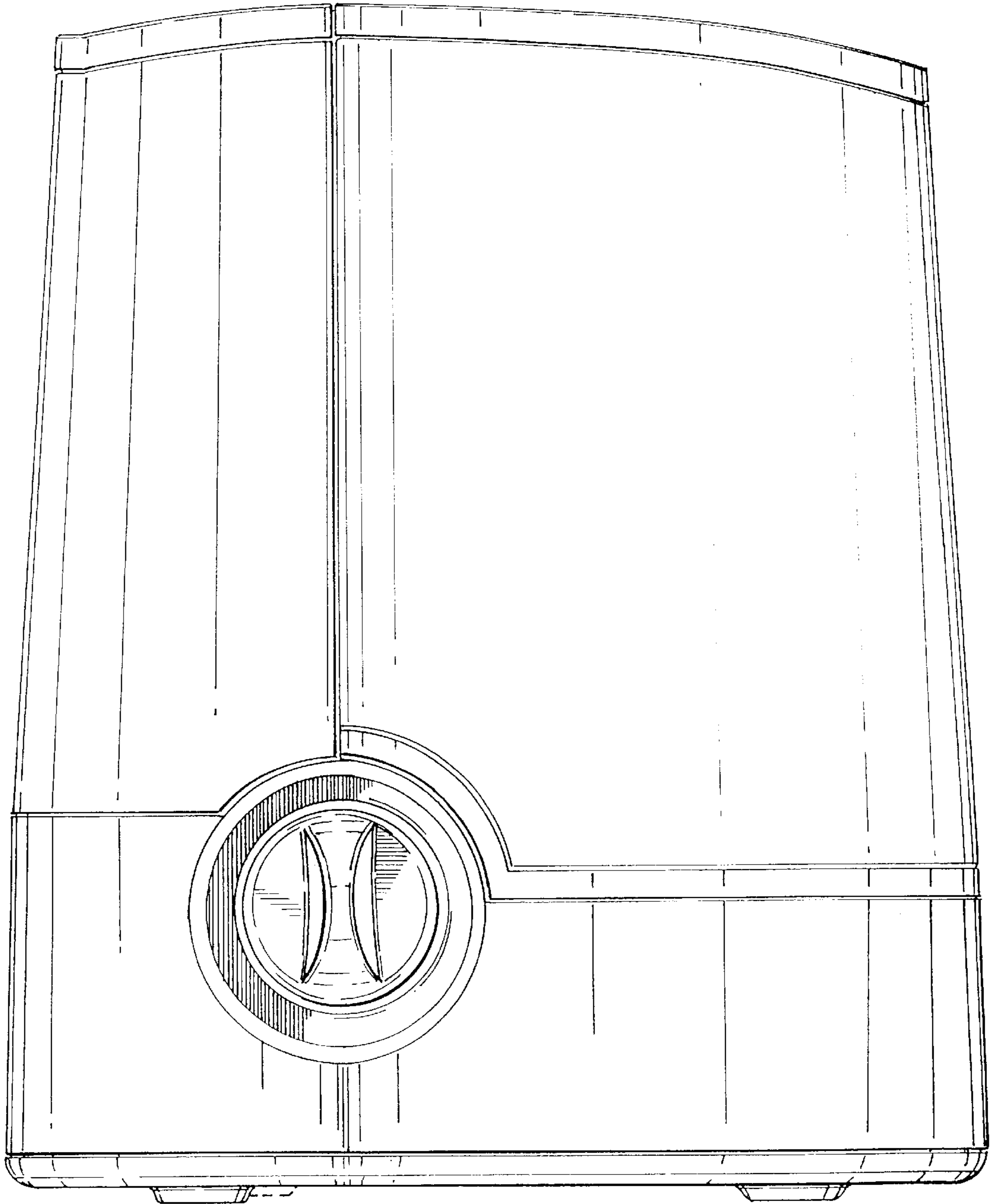


***Fig. 9***





**Fig. 10**



**Fig. 11**