



US00D481081S

(12) **United States Design Patent**
Okutsu

(10) **Patent No.:** **US D481,081 S**

(45) **Date of Patent:** **** Oct. 21, 2003**

(54) **MONSTER TOY**

(75) Inventor: **Masamichi Okutsu, Katsushika-ku (JP)**

(73) Assignee: **Tomy Company, Limited, Tokyo (JP)**

(**) Term: **14 Years**

(21) Appl. No.: **29/168,010**

(22) Filed: **Sep. 26, 2002**

(30) **Foreign Application Priority Data**

Mar. 28, 2002 (JP) 2002-008260

(51) **LOC (7) Cl.** **21-01**

(52) **U.S. Cl.** **D21/578; D21/615**

(58) **Field of Search** **D11/158, 162;**
D21/576, 578-585, 606, 615; 446/71-72,
97, 102, 316-317, 368

(56) **References Cited**

U.S. PATENT DOCUMENTS

D286,901 S * 11/1986 Ohno D21/584

D294,611 S * 3/1988 Shinohara D21/584
D301,353 S * 5/1989 Matsuda D21/584
D318,500 S * 7/1991 Malewicky et al. D21/578

* cited by examiner

Primary Examiner—Sandra L. Morris
(74) *Attorney, Agent, or Firm*—Oliff & Berridge, PLC

(57) **CLAIM**

The ornamental design for a monster toy, as shown and described.

DESCRIPTION

FIG. 1 is a perspective view of a monster toy;
FIG. 2 is a front view thereof;
FIG. 3 is a rear view thereof;
FIG. 4 is a left-side view thereof;
FIG. 5 is a right-side view thereof;
FIG. 6 is a top view thereof; and,
FIG. 7 is a bottom view thereof.

1 Claim, 3 Drawing Sheets

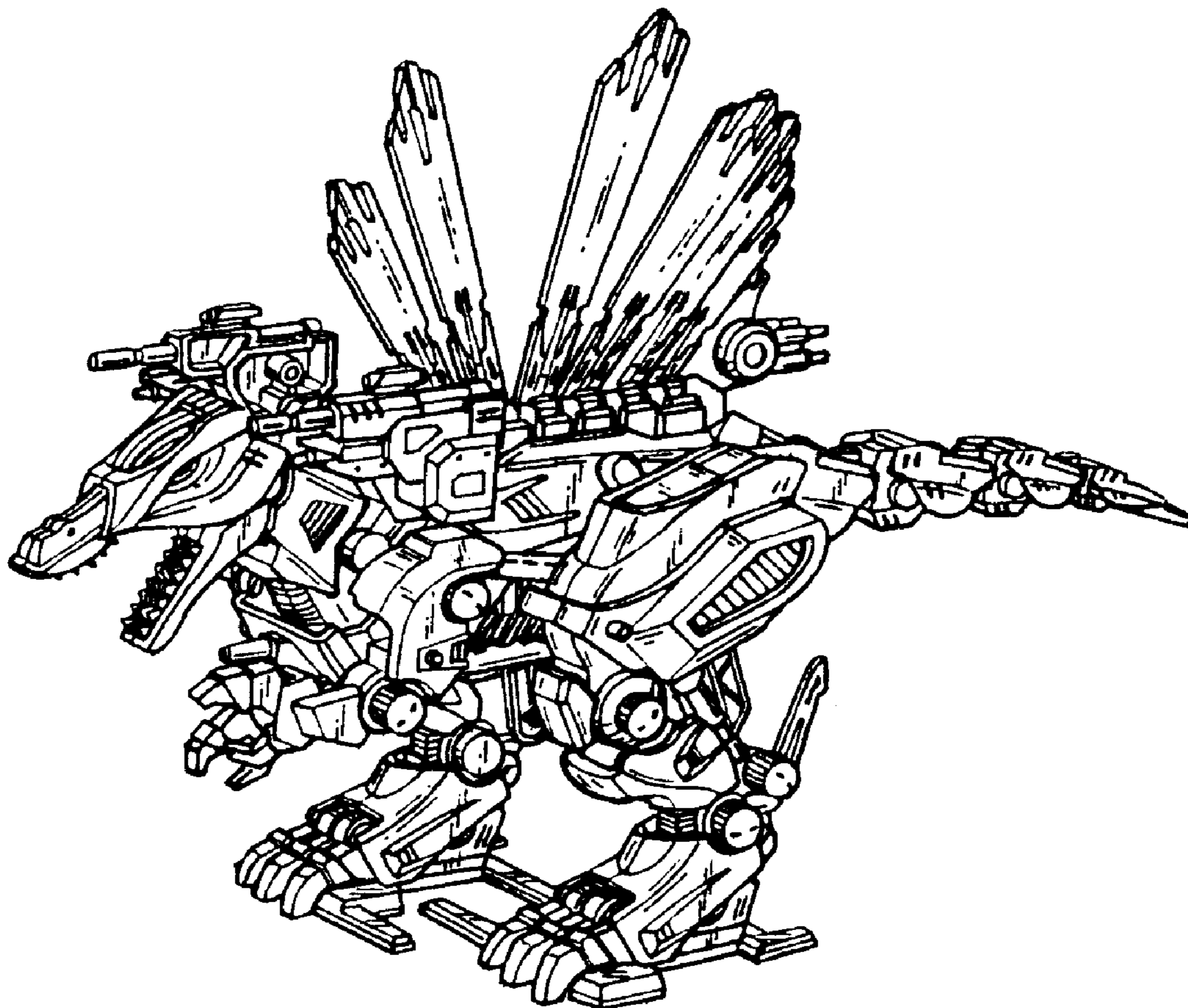

FIG. 1

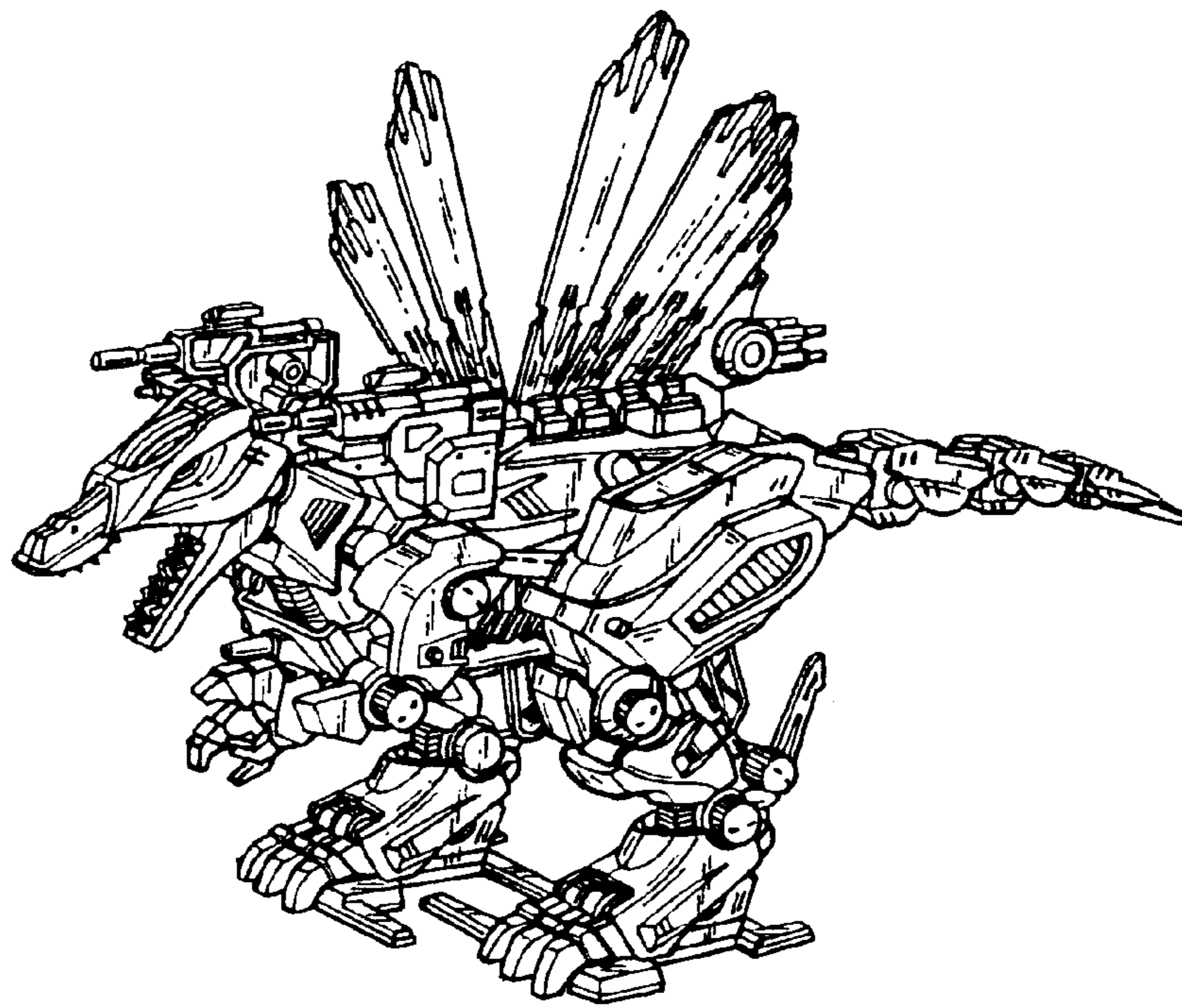

FIG. 2

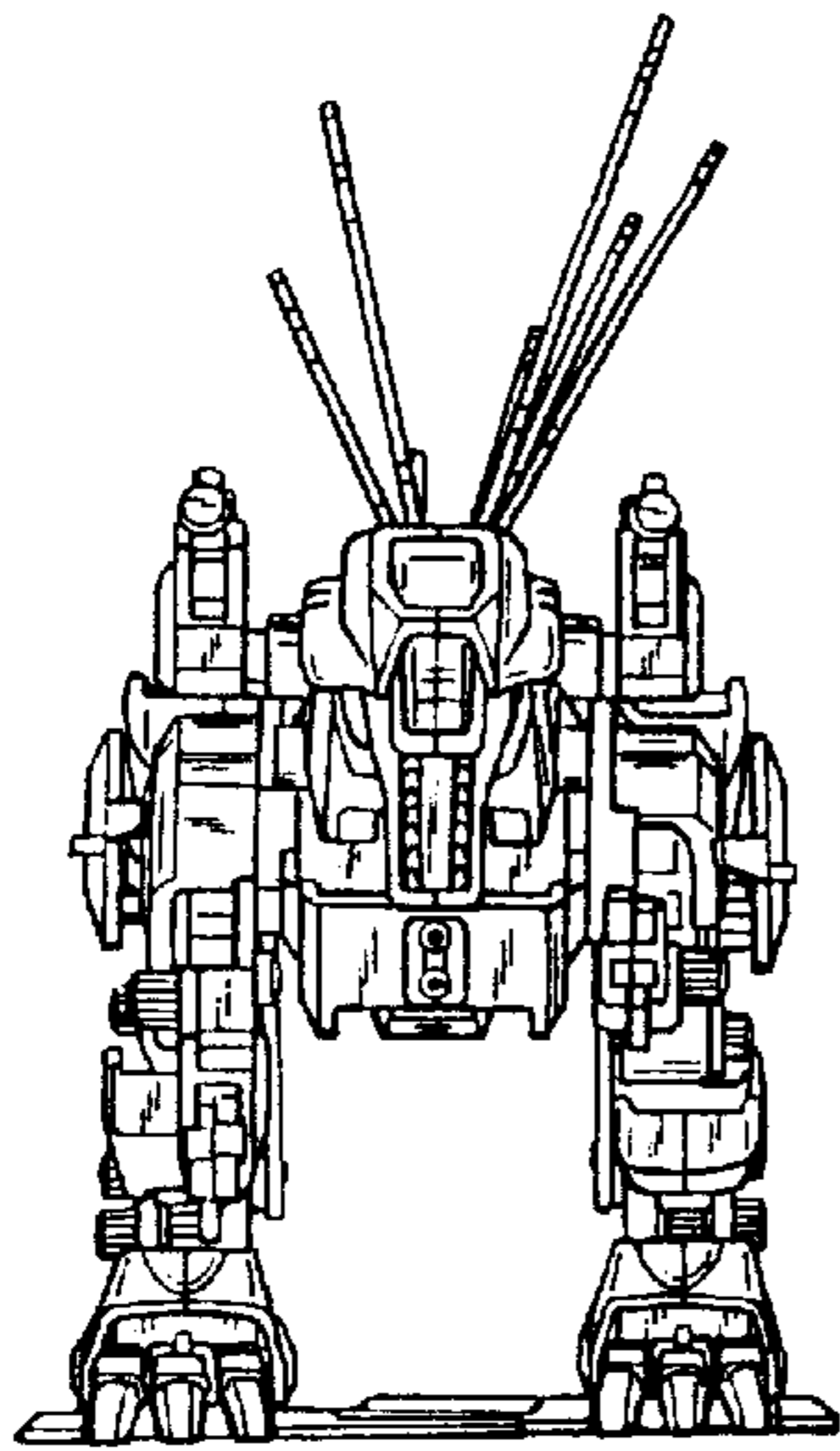

FIG. 3

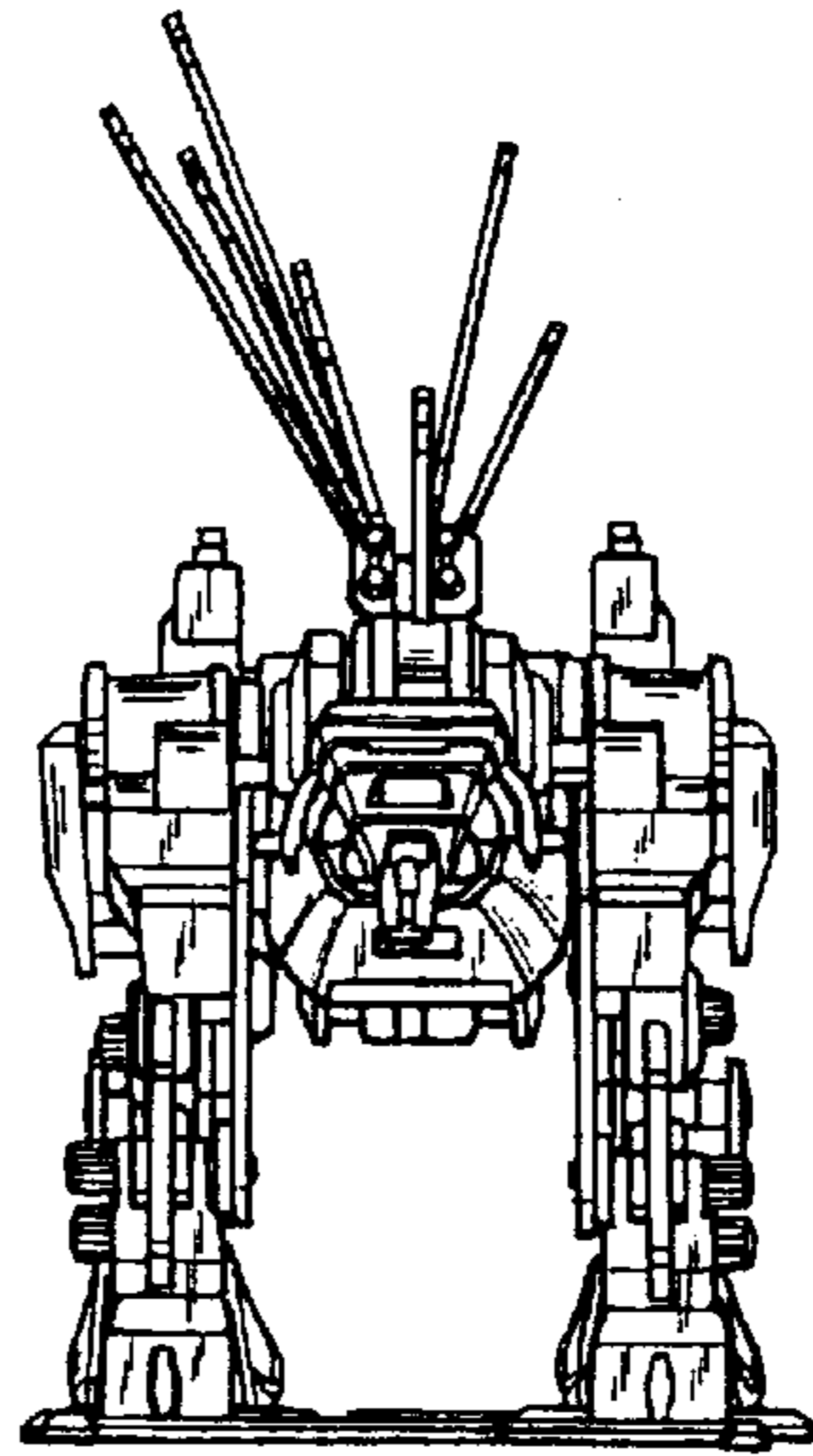

FIG. 4

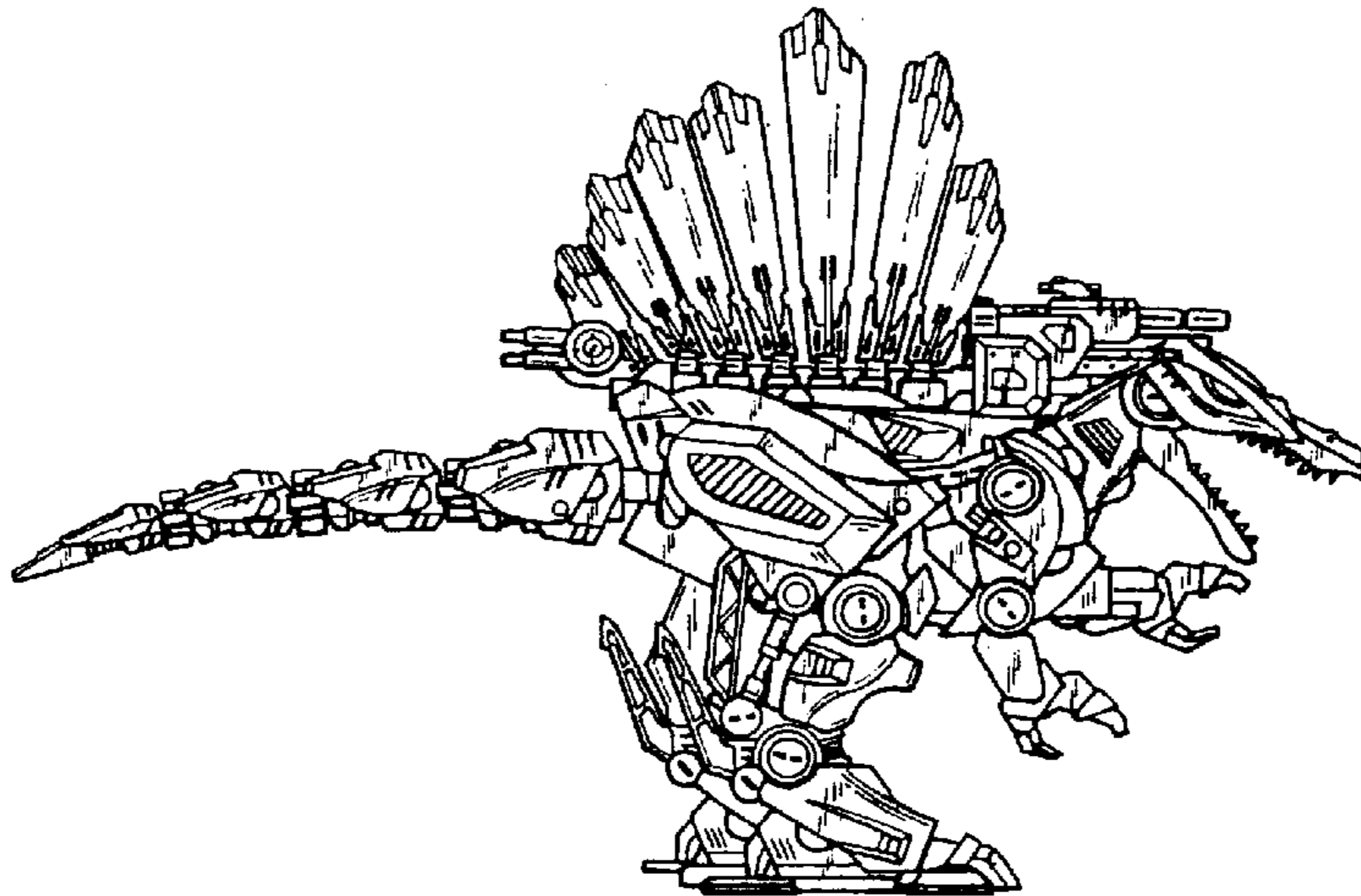

FIG. 5

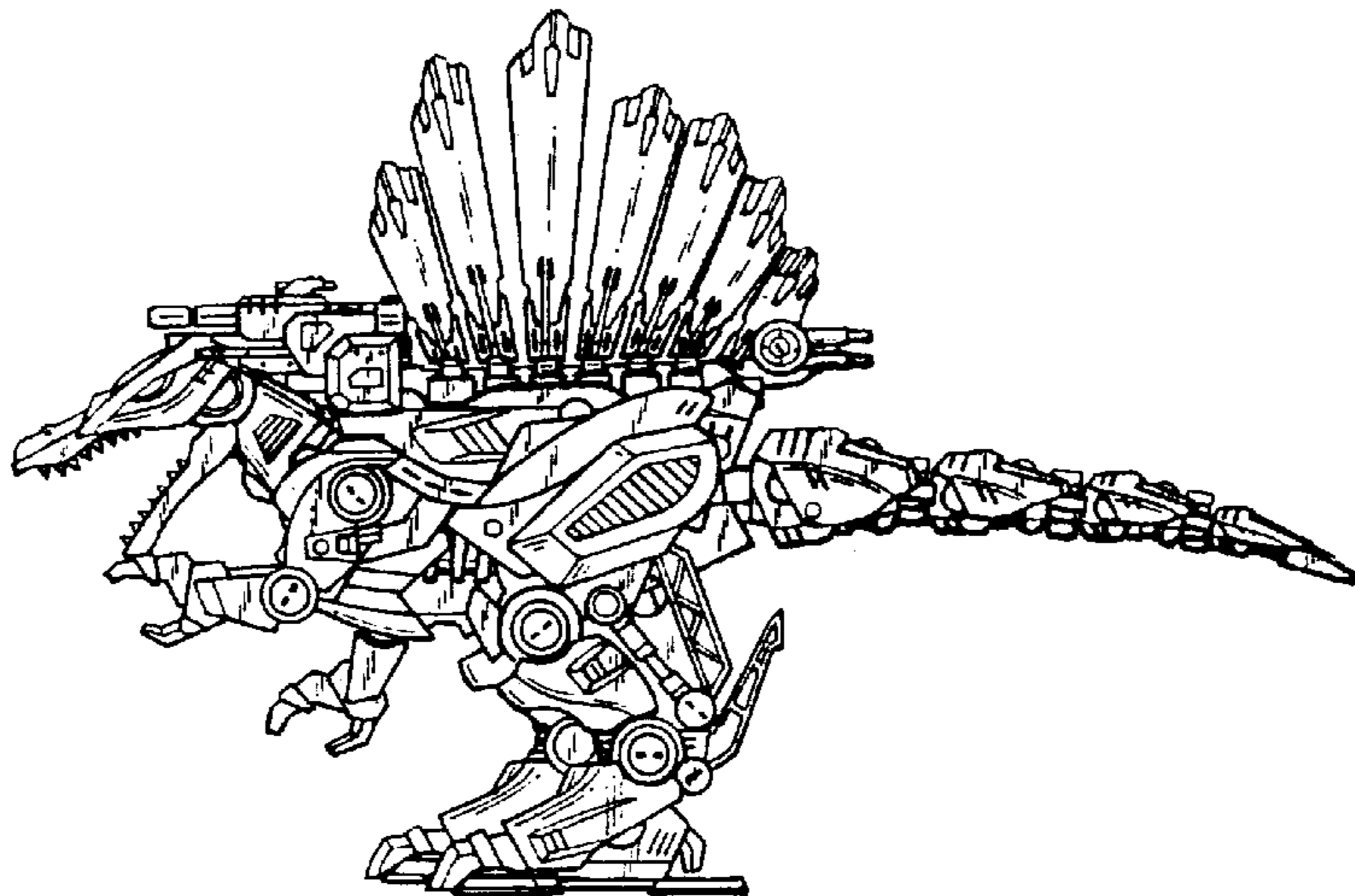

FIG. 6

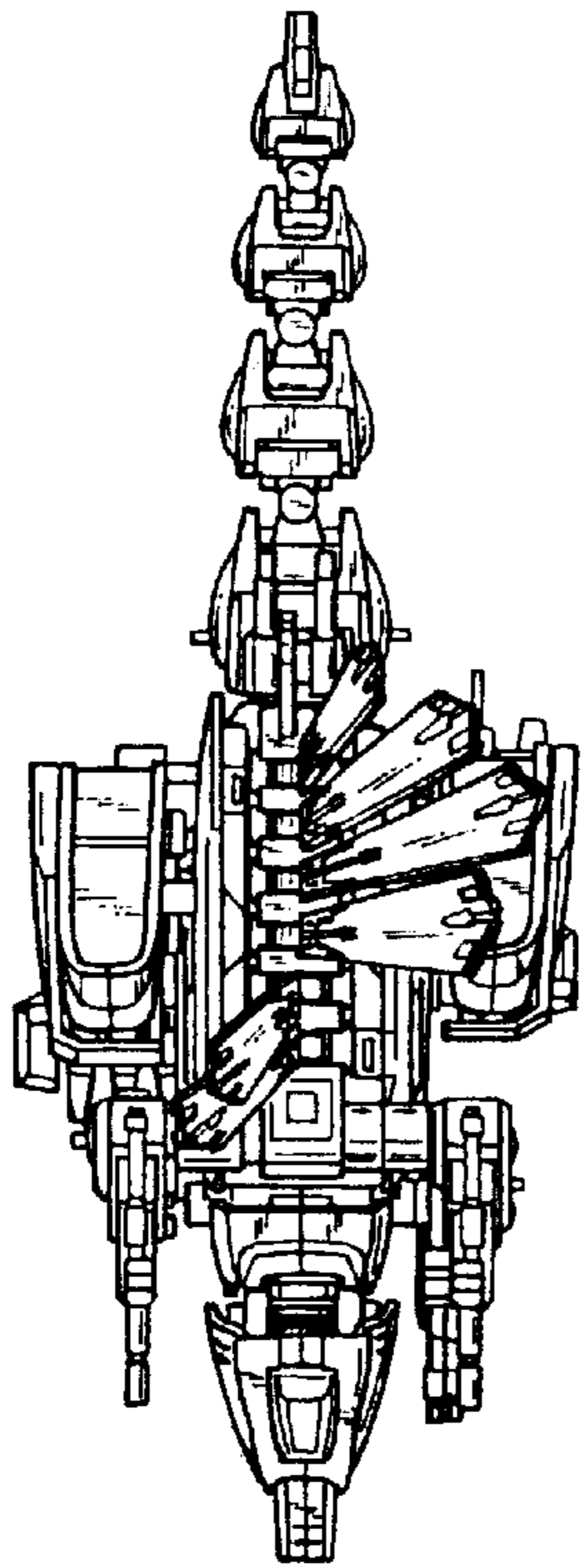

FIG. 7

