



US00D481044S

(12) **United States Design Patent**
Tokach et al.

(10) **Patent No.:** **US D481,044 S**

(45) **Date of Patent:** **** Oct. 21, 2003**

(54) **MINI-EXCAVATOR CAB EXTERIOR**

(75) Inventors: **Thomas J. Tokach**, Mandan, ND (US);
Michael D. Wetzel, Bismarck, ND
(US); **Henry J. Weber**, Bismarck, ND
(US); **Troy D. Kraft**, Wahpeton, ND
(US)

(73) Assignee: **Clark Equipment Company**, Woodcliff
Lake, NJ (US)

(**) Term: **14 Years**

(21) Appl. No.: **29/168,140**

(22) Filed: **Sep. 26, 2002**

(51) **LOC (7) Cl.** **15-03**

(52) **U.S. Cl.** **D15/30**

(58) **Field of Search** D15/10, 22-26,
D15/28, 30; 180/89.1, 89.12, 900; 296/190.1;
414/680, 685, 694, 698, 719, 722, 743

(56) **References Cited**

U.S. PATENT DOCUMENTS

| | | | | | |
|-------------|---|---------|-----------------|-------|------------|
| D237,996 S | * | 12/1975 | Marie | | D15/30 |
| 4,650,242 A | * | 3/1987 | Obe et al. | | 296/190.08 |
| 5,184,933 A | | 2/1993 | Pei-qian et al. | | 414/725 |
| 6,018,895 A | | 2/2000 | Duppong et al. | | 37/348 |
| D432,144 S | * | 10/2000 | Kraft et al. | | D15/30 |
| D432,145 S | * | 10/2000 | Kraft et al. | | D15/30 |

| | | | | | |
|--------------|---|---------|--------------|-------|--------|
| D433,689 S | * | 11/2000 | Kraft et al. | | D15/30 |
| D436,605 S | * | 1/2001 | Shaw et al. | | D15/30 |
| 6,170,180 B1 | | 1/2001 | Schaeff | | 37/443 |
| 6,357,231 B1 | | 3/2002 | Duppong | | 60/421 |

* cited by examiner

Primary Examiner—Mitchell Siegel

(74) *Attorney, Agent, or Firm*—Westman, Champlin &
Kelly, P.A.

(57) **CLAIM**

The ornamental design for a mini-excavator cab exterior, as shown and described.

DESCRIPTION

FIG. 1 is a view in perspective as seen from the front, side and top of the mini-excavator cab showing our new design with the vehicle shown in dashed lines representing environment;

FIG. 2 is a view in perspective as seen from the front, top and side opposite that shown in FIG. 1;

FIG. 3 is a view in side elevation;

FIG. 4 is a view in side elevation of the side opposite that shown in FIG. 3;

FIG. 5 is a view in front elevation;

FIG. 6 is a view in rear elevation;

FIG. 7 is a top plan view; and,

FIG. 8 is a bottom plan view.

1 Claim, 8 Drawing Sheets

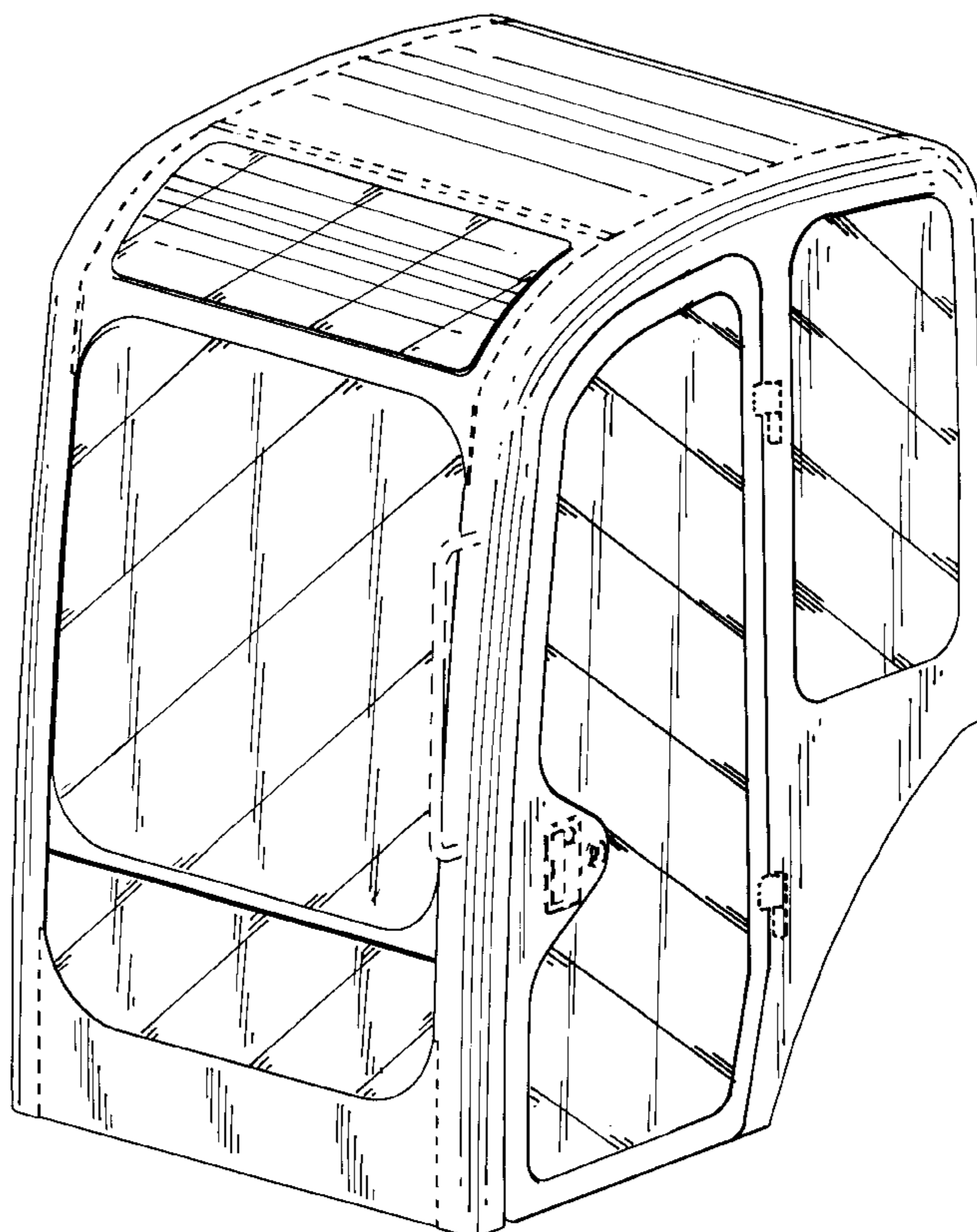
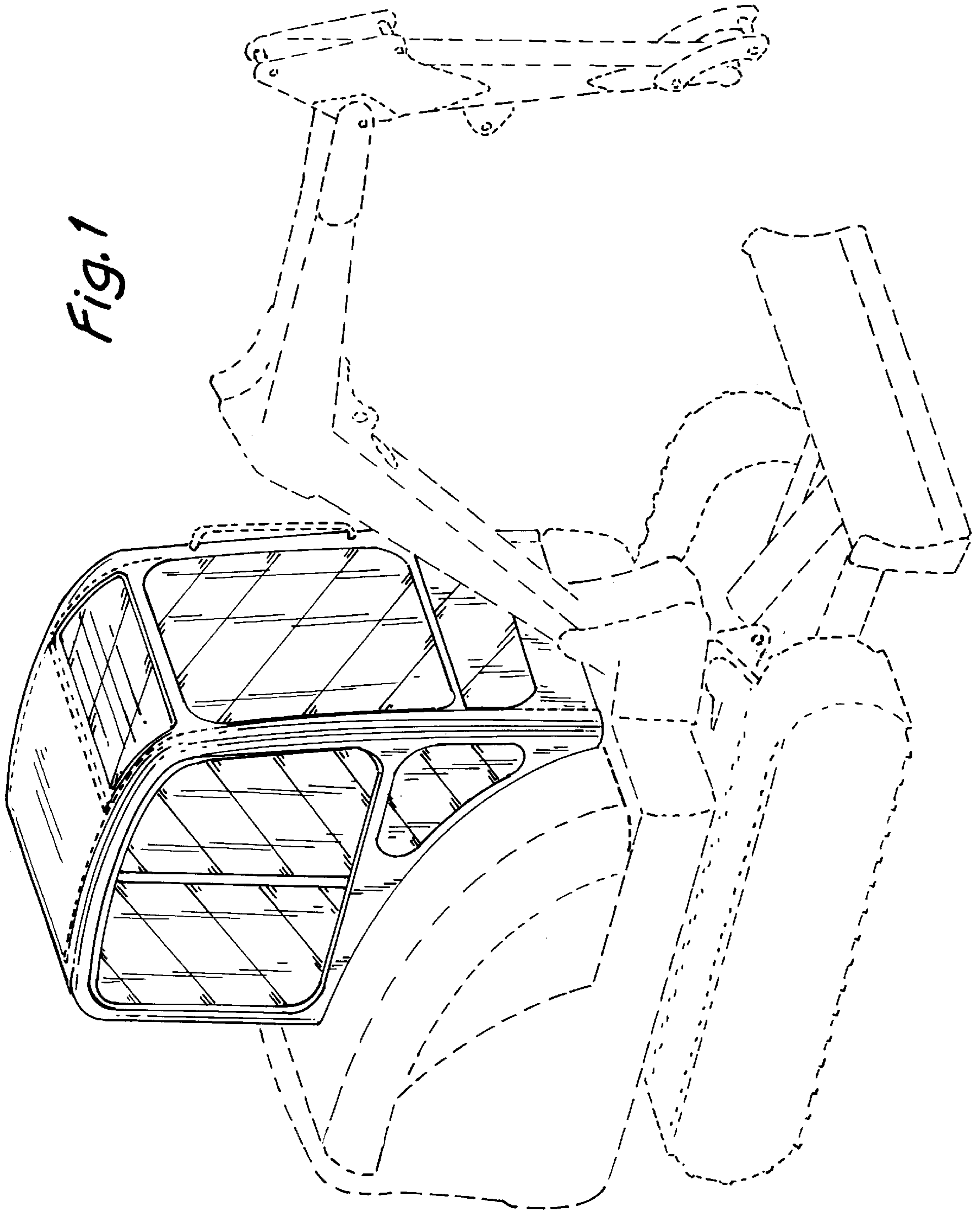

Fig. 1



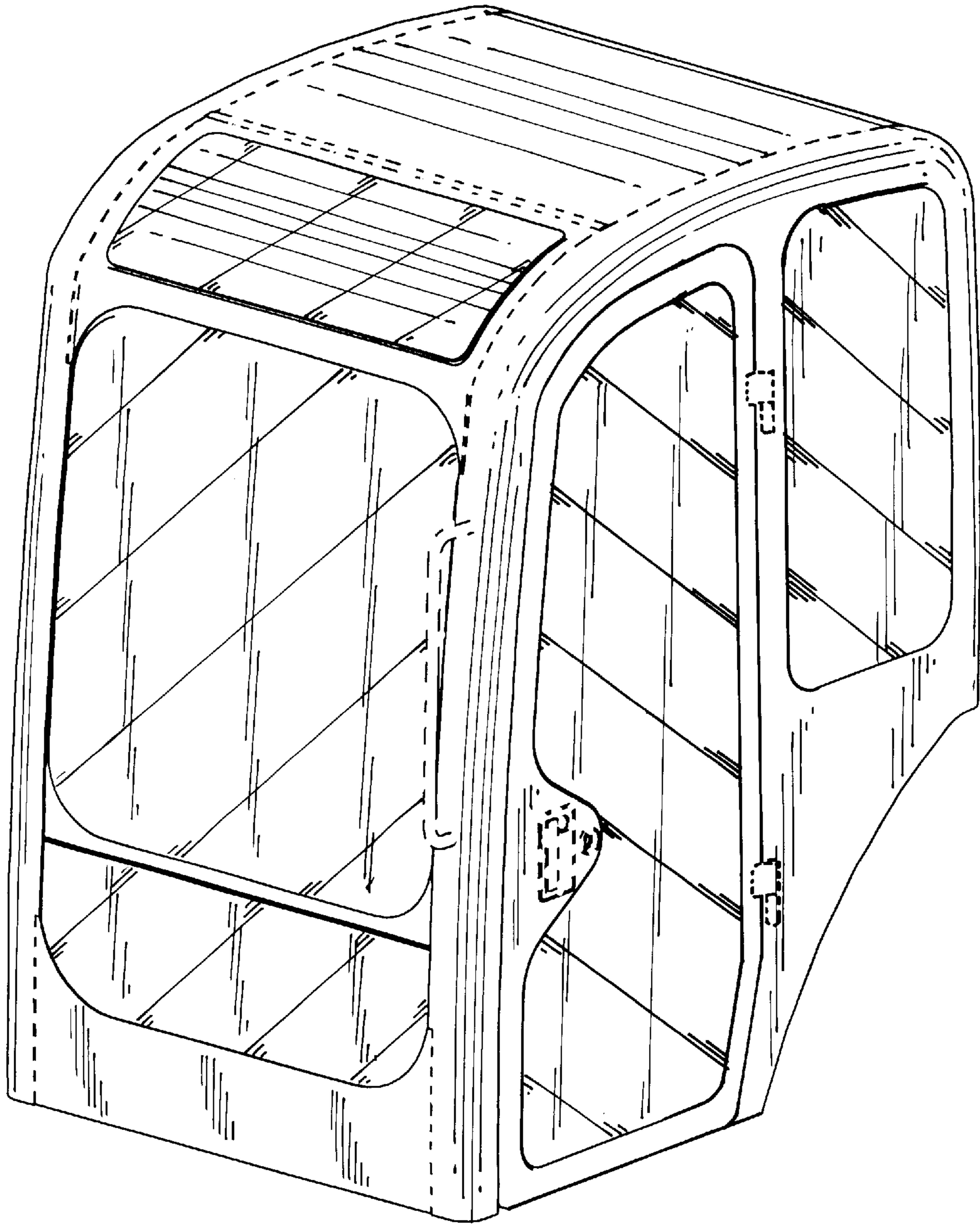

Fig. 2

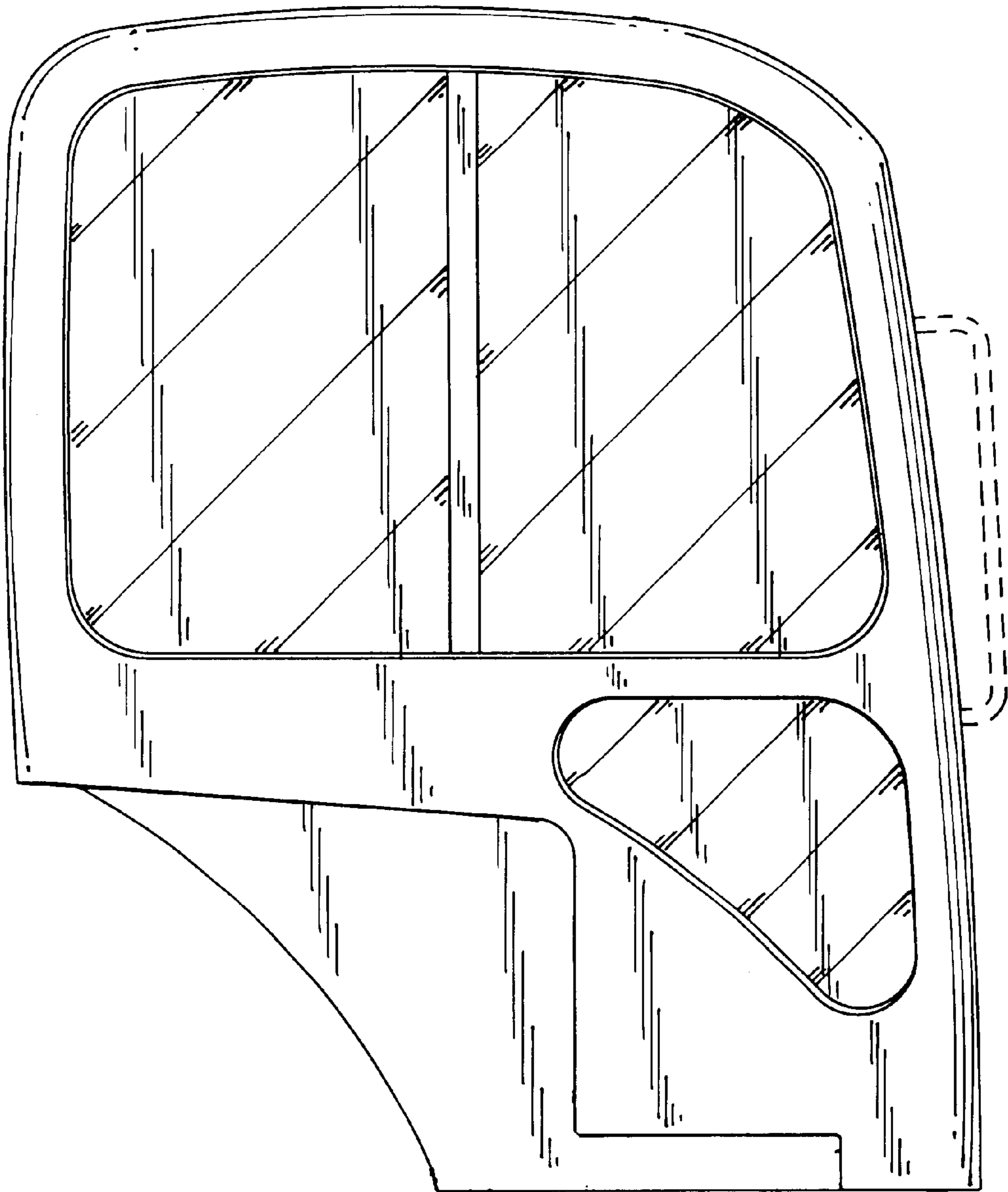

Fig. 3

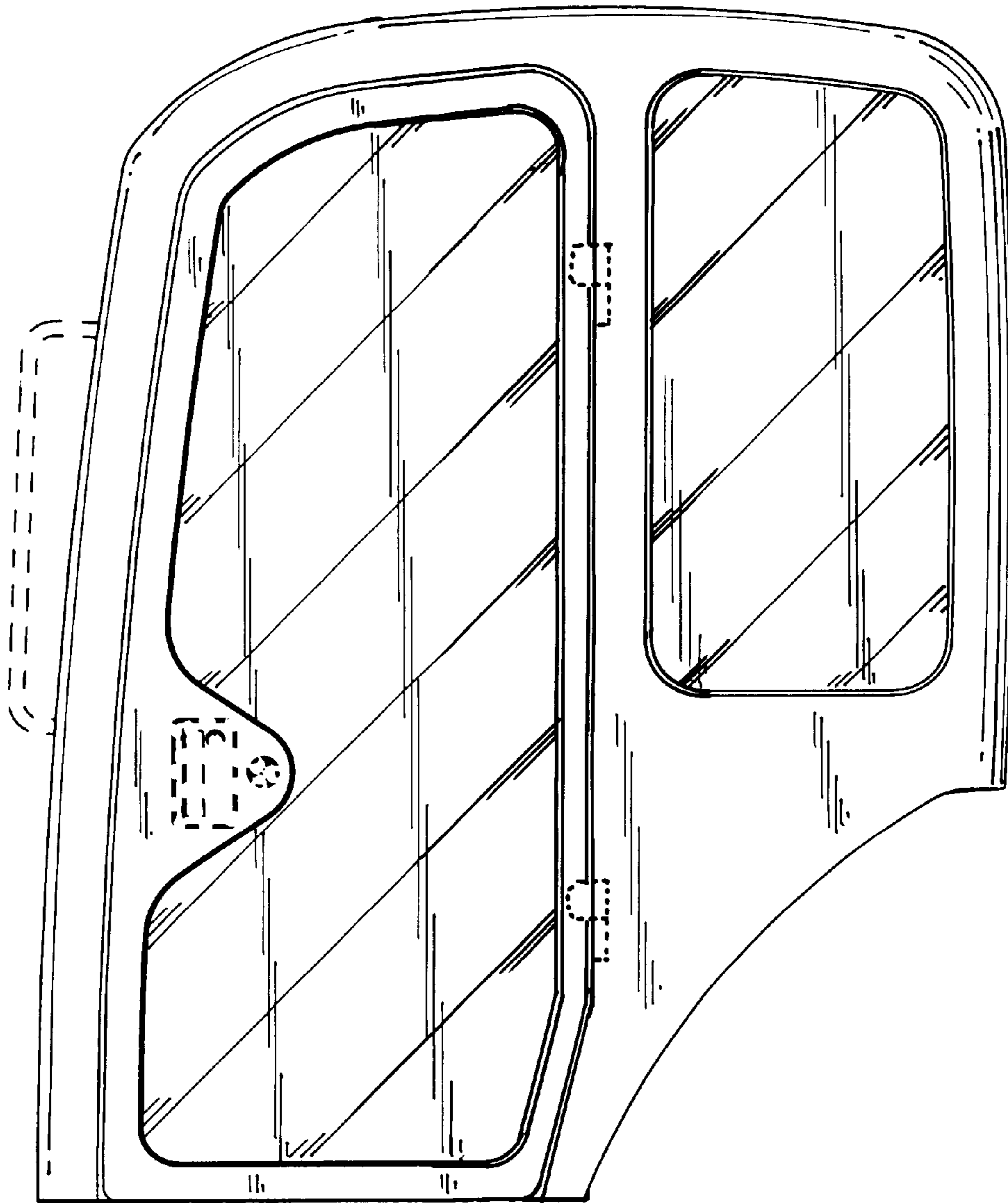

Fig. 4

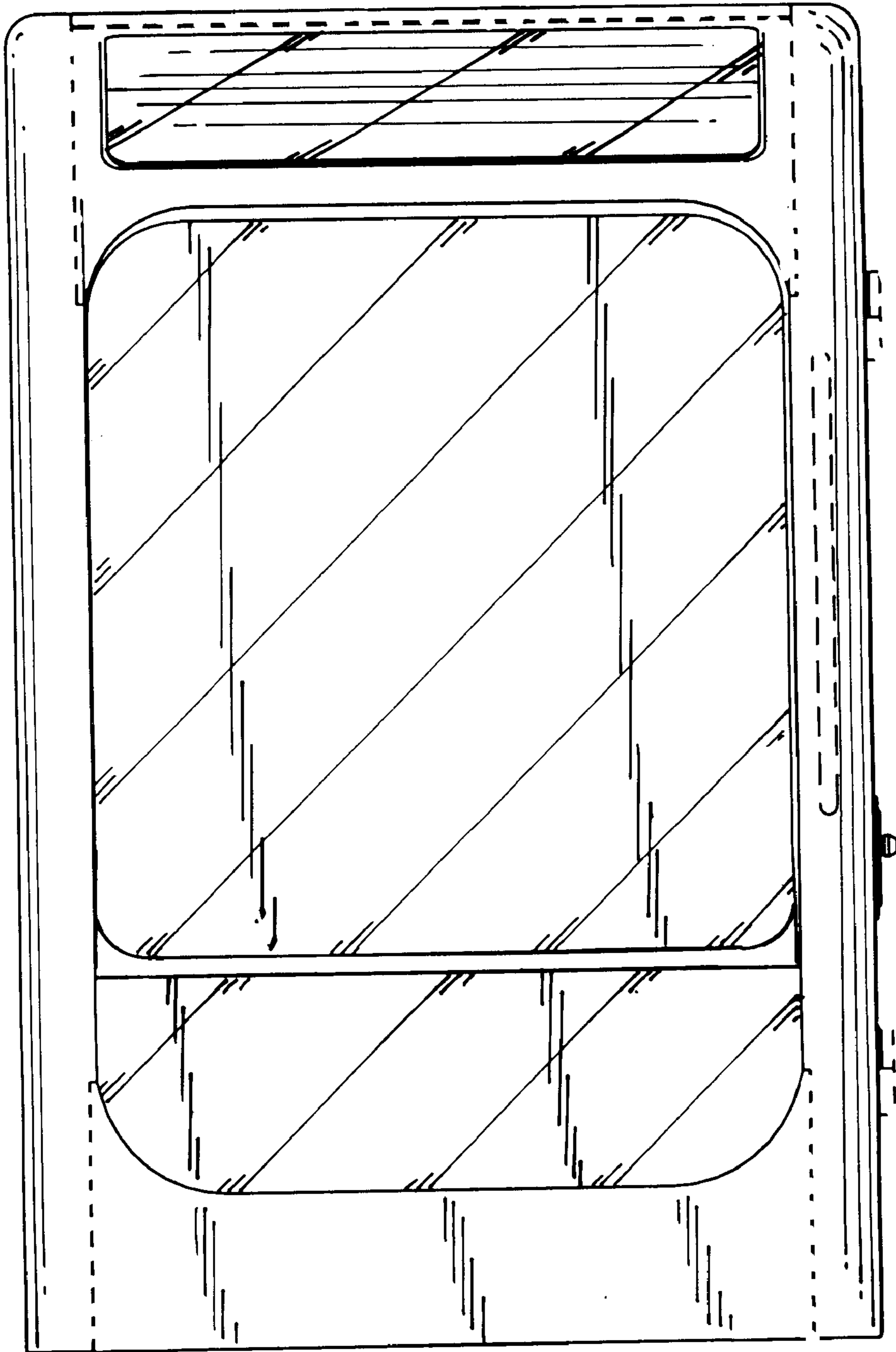

Fig. 5

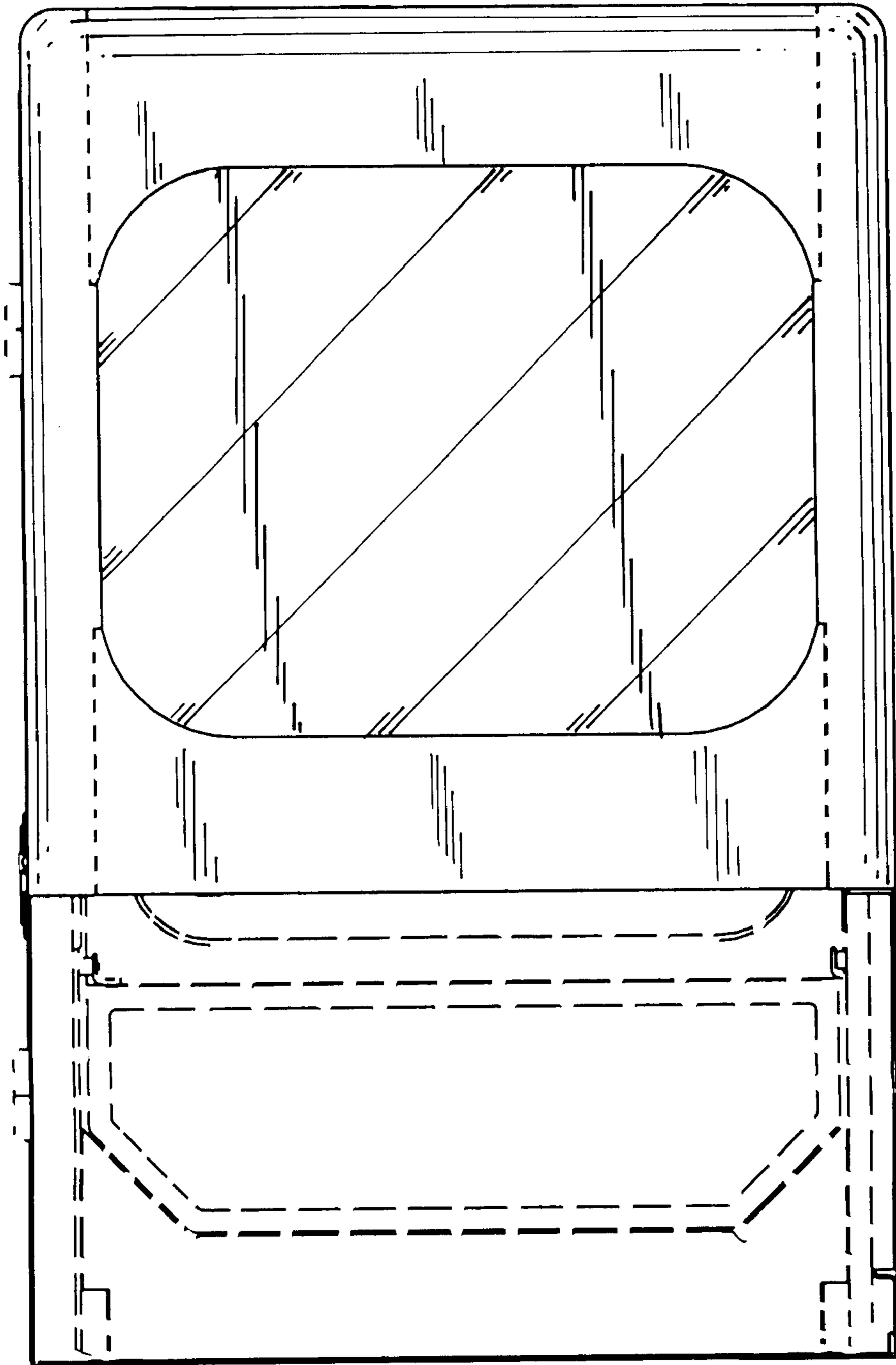

Fig. 6

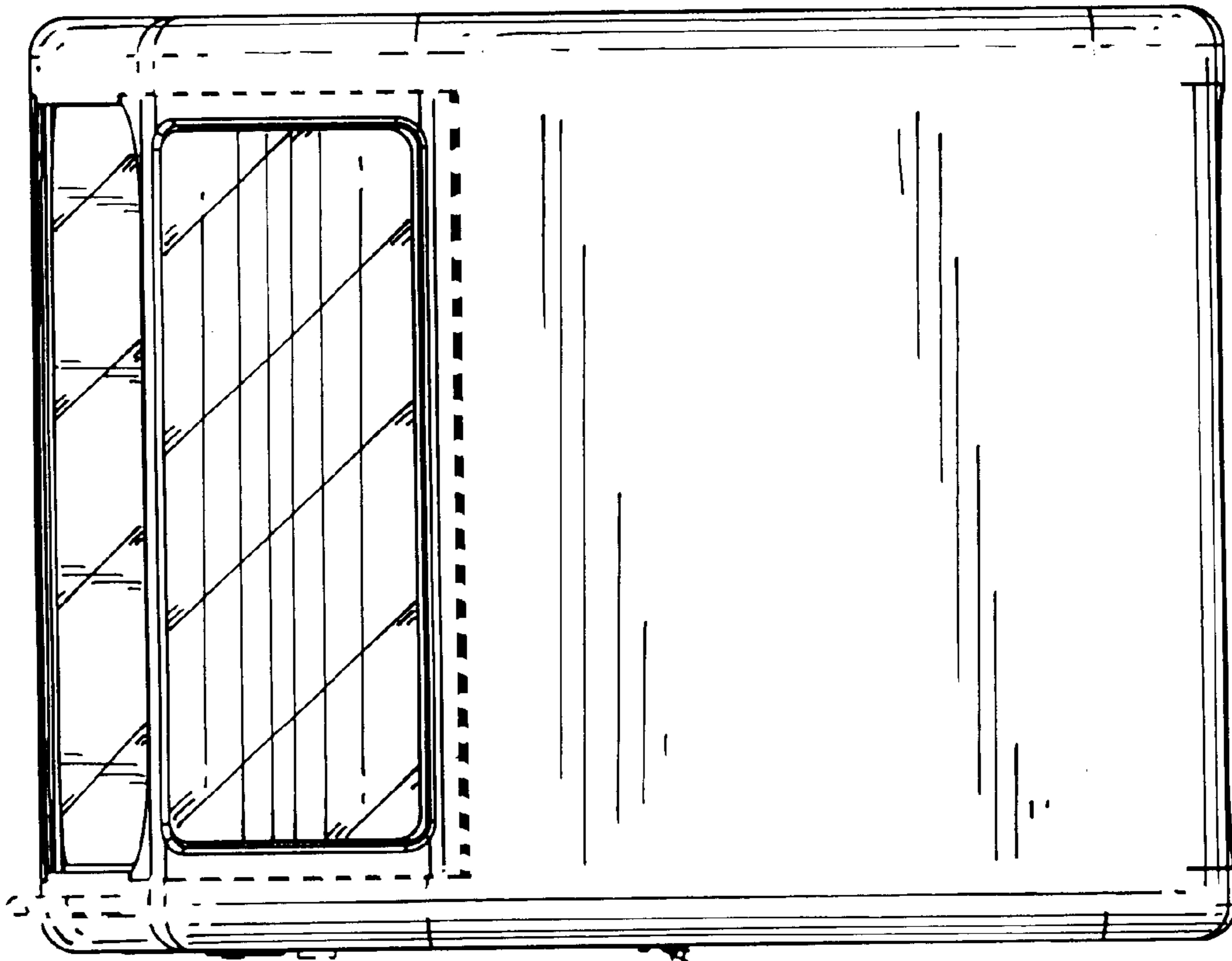

Fig. 7

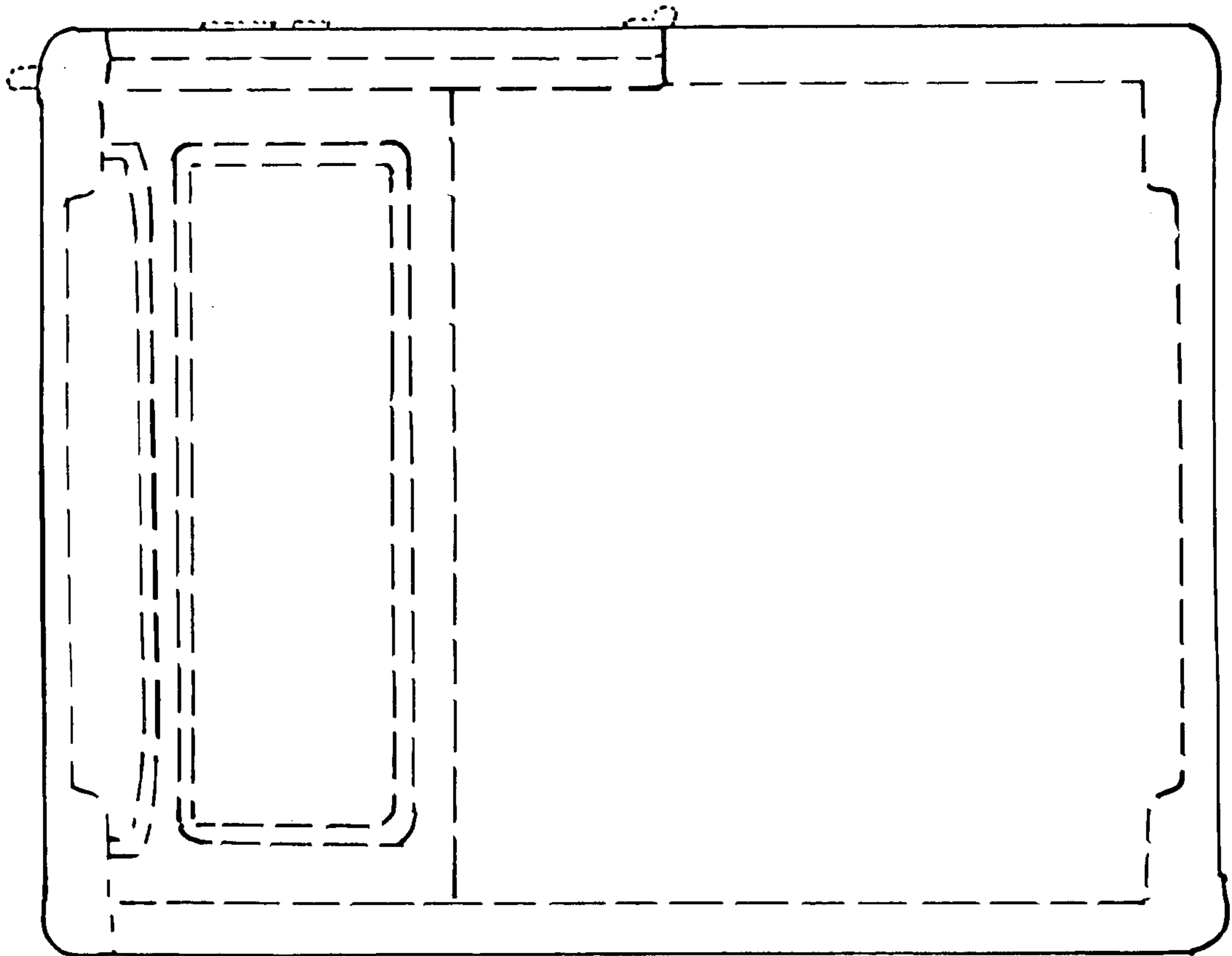

Fig. 8