



US00D481017S

(12) **United States Design Patent**  
**Hsia et al.**

(10) **Patent No.:** **US D481,017 S**

(45) **Date of Patent:** **\*\* Oct. 21, 2003**

(54) **HEAT SINK**

(75) Inventors: **Chih-Hao Hsia**, Banqiao (TW);  
**Kuo-Cheng Lin**, Taoyuan (TW);  
**Wen-Shi Huang**, Taoyuan (TW)

(73) Assignee: **Delta Electronics Inc.**, Taoyuan Hsien (TW)

(\*\*) Term: **14 Years**

(21) Appl. No.: **29/171,546**

(22) Filed: **Nov. 25, 2002**

(30) **Foreign Application Priority Data**

Sep. 13, 2002 (TW) ..... 91305155

(51) **LOC (7) Cl.** ..... **13-03**

(52) **U.S. Cl.** ..... **D13/179**

(58) **Field of Search** ..... D13/179; 174/16.3,  
174/52.4; 165/80.3, 104.14, 104.33, 121,  
122, 180, 185; 206/713, 714, 715, 716,  
727, 728; 257/706, 707, 718, 719, 720,  
721, 722, 727, 686; 361/271, 274.3, 697,  
702, 704, 709, 710, 711

(56) **References Cited**

**U.S. PATENT DOCUMENTS**

5,368,094 A \* 11/1994 Hung ..... 165/80.3

D357,670 S \* 4/1995 Dodson ..... D13/179  
5,495,392 A \* 2/1996 Shen ..... 361/697  
6,161,611 A \* 12/2000 Cheng ..... 165/80.3  
D450,044 S \* 11/2001 Lindstrom ..... D13/179  
6,373,701 B1 \* 4/2002 Lo ..... 361/704  
D465,462 S \* 11/2002 Hsieh ..... D13/179

\* cited by examiner

*Primary Examiner*—Ted Shooman

*Assistant Examiner*—Selina Sikder

(74) *Attorney, Agent, or Firm*—Birch, Stewart, Kolasch & Birch, LLP

(57) **CLAIM**

The ornamental design for heat sink, as shown and deccribed herein.

**DESCRIPTION**

FIG. 1 is a perspective view of heat sink showing our new design;

FIG. 2 is a right side view thereof;

FIG. 3 is a top view thereof;

FIG. 4 is a front view thereof;

FIG. 5 is a bottom view thereof;

FIG. 6 is a left side view thereof; and,

FIG. 7 is a rear view thereof.

**1 Claim, 7 Drawing Sheets**

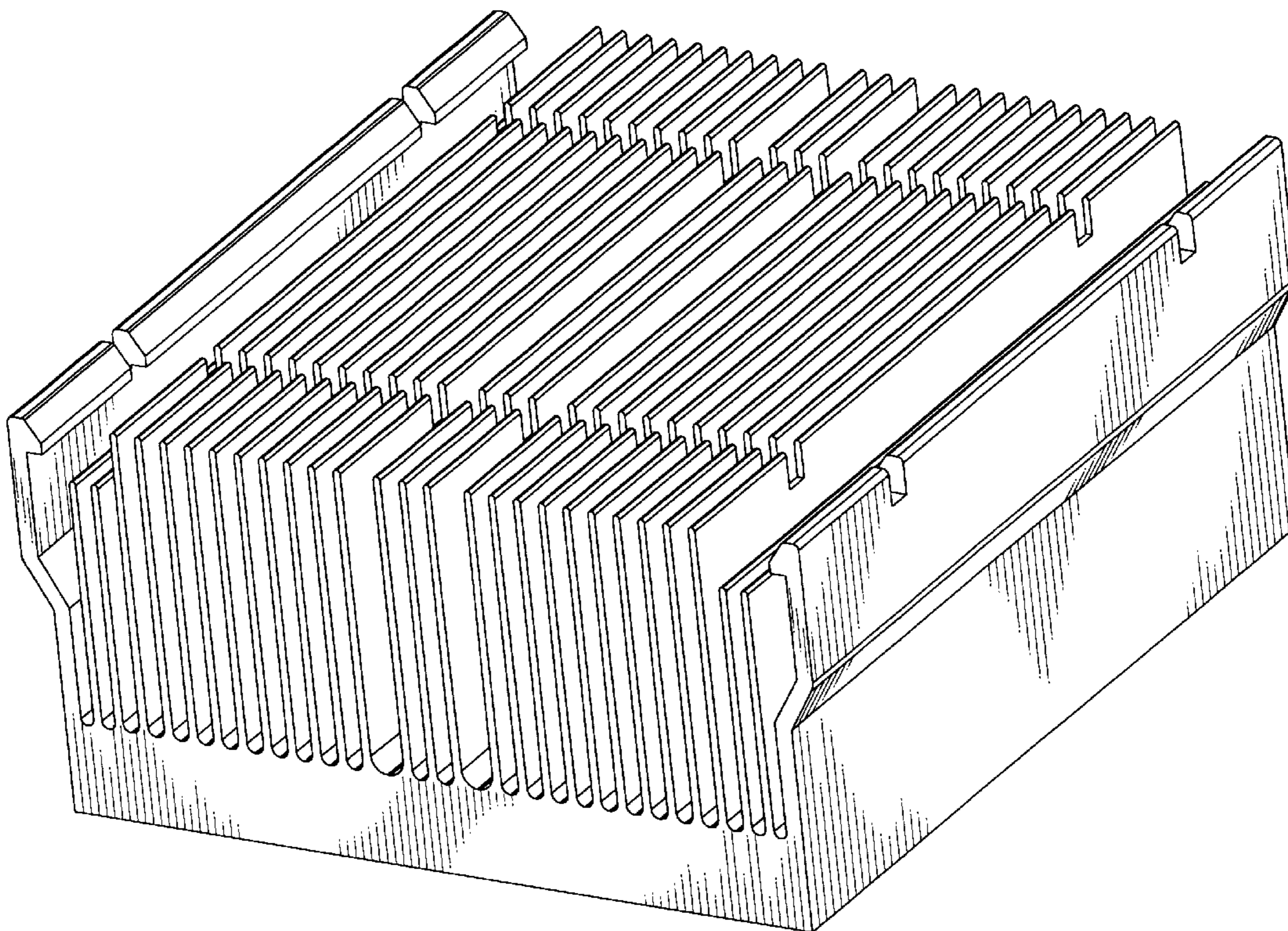

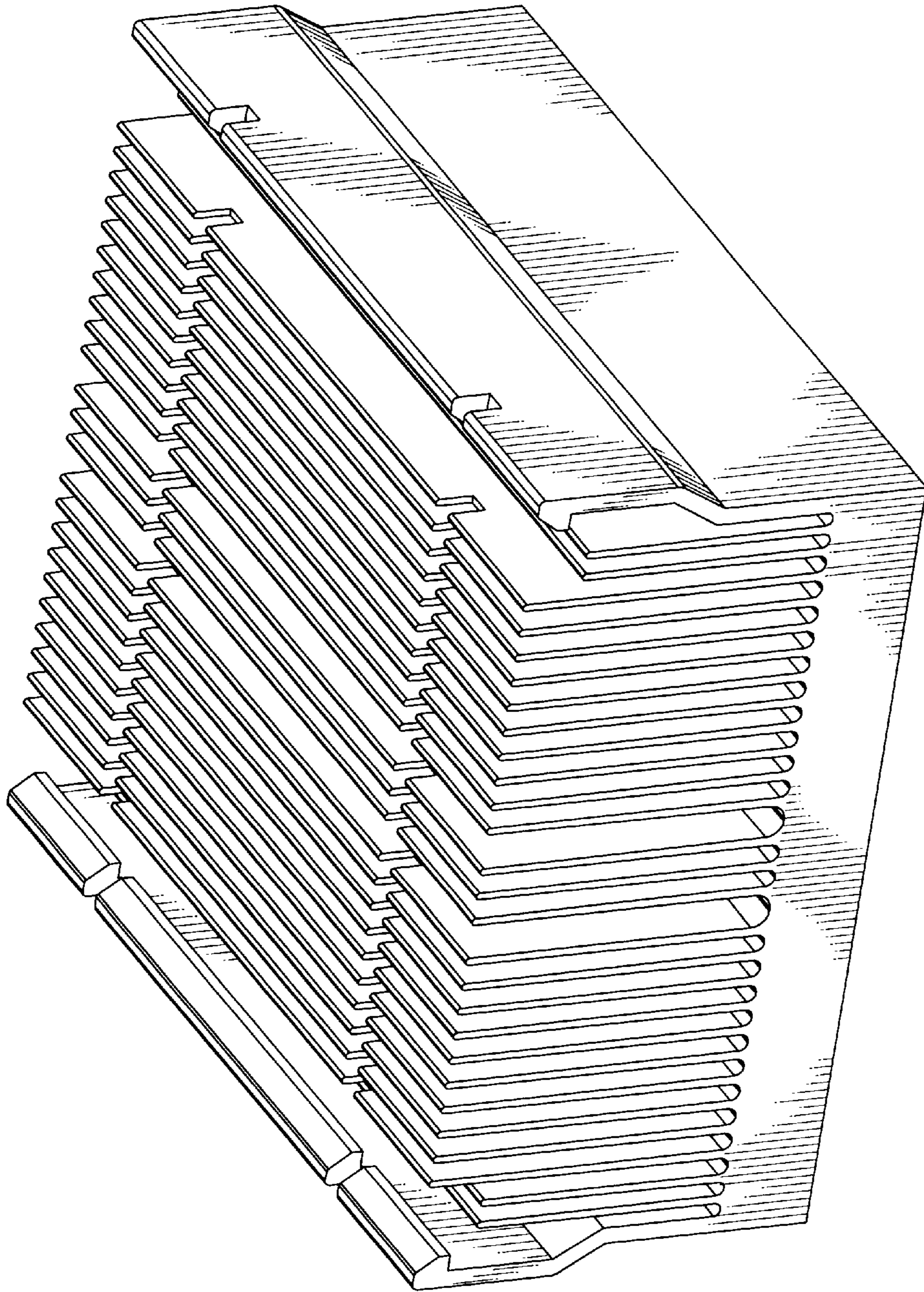

FIG. 1

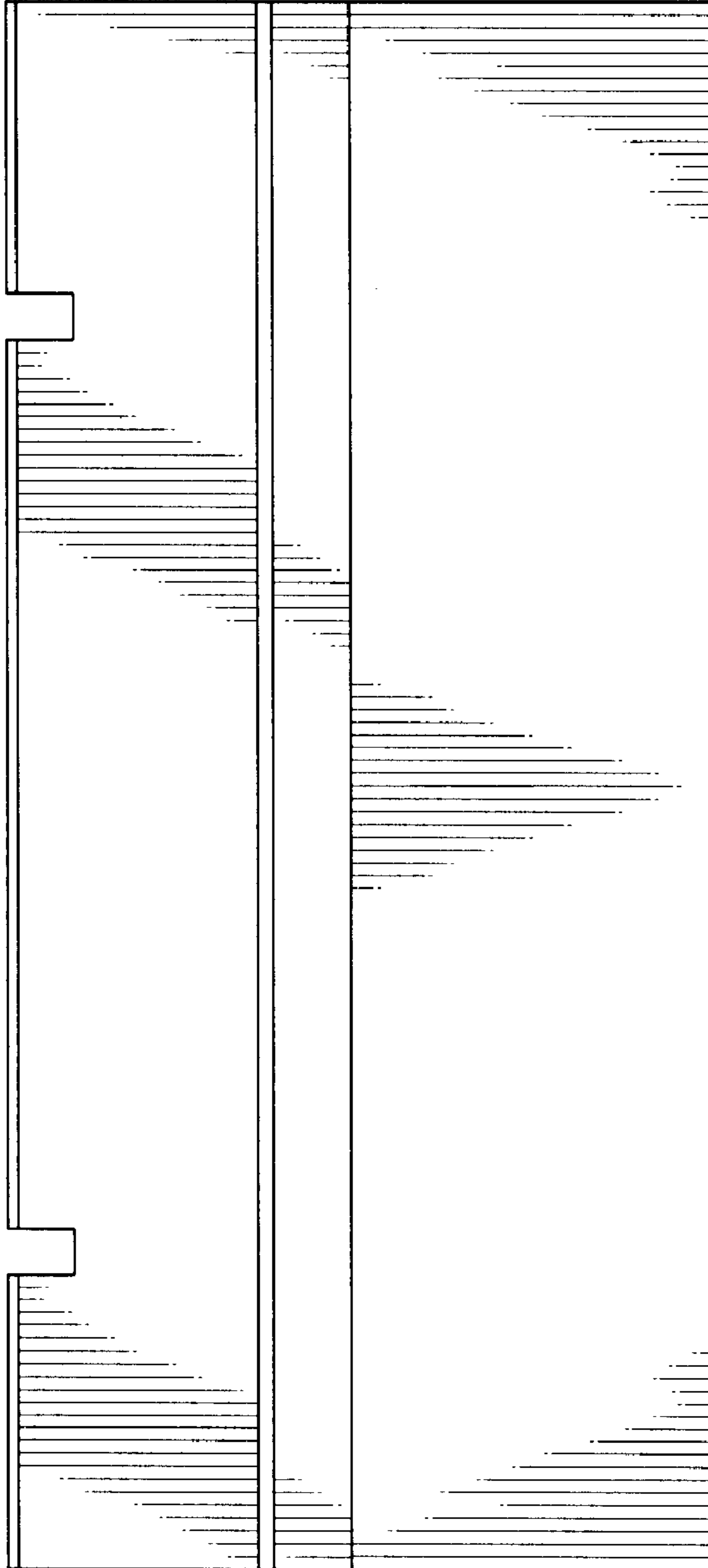

FIG. 2

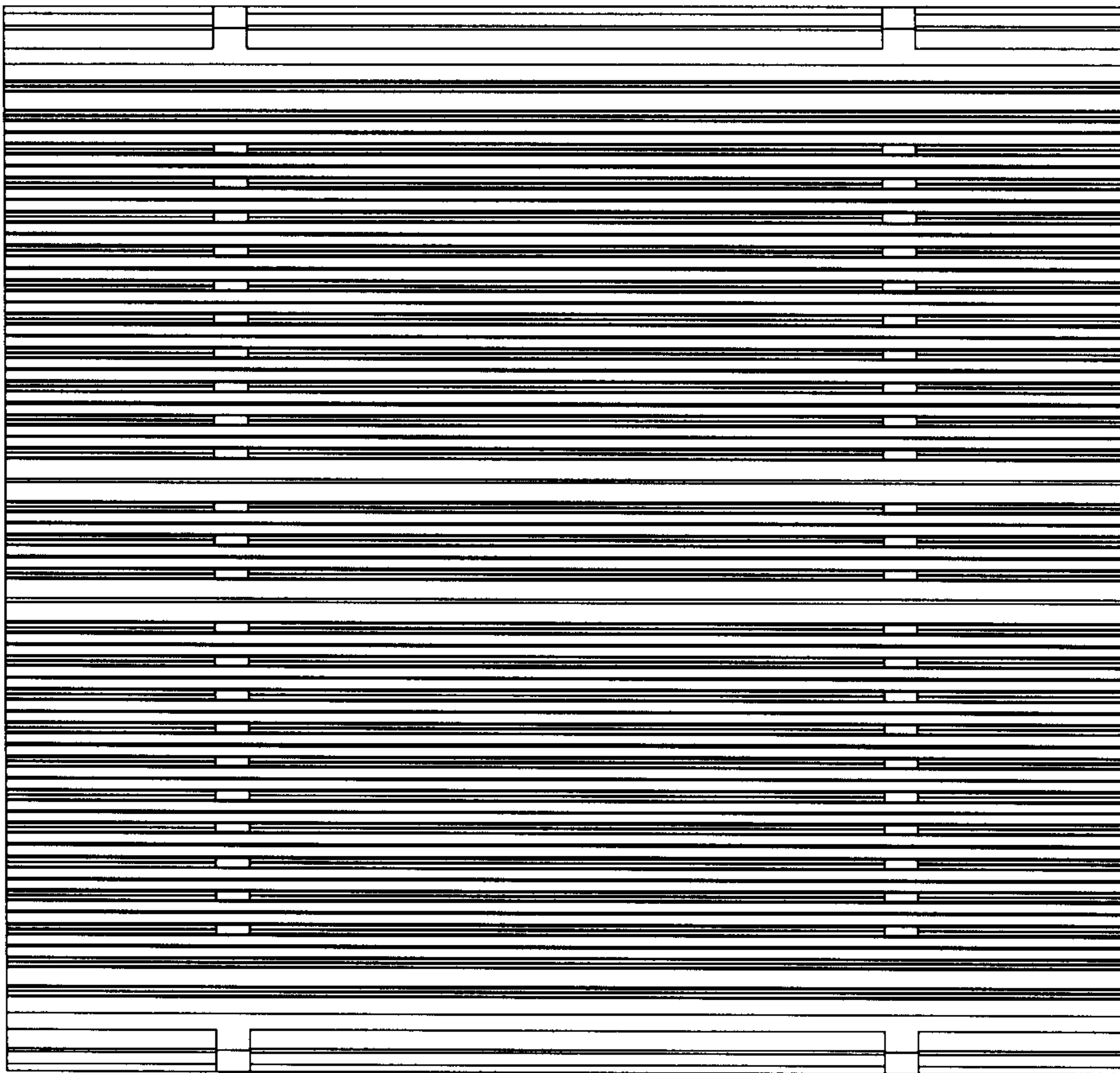

FIG. 3

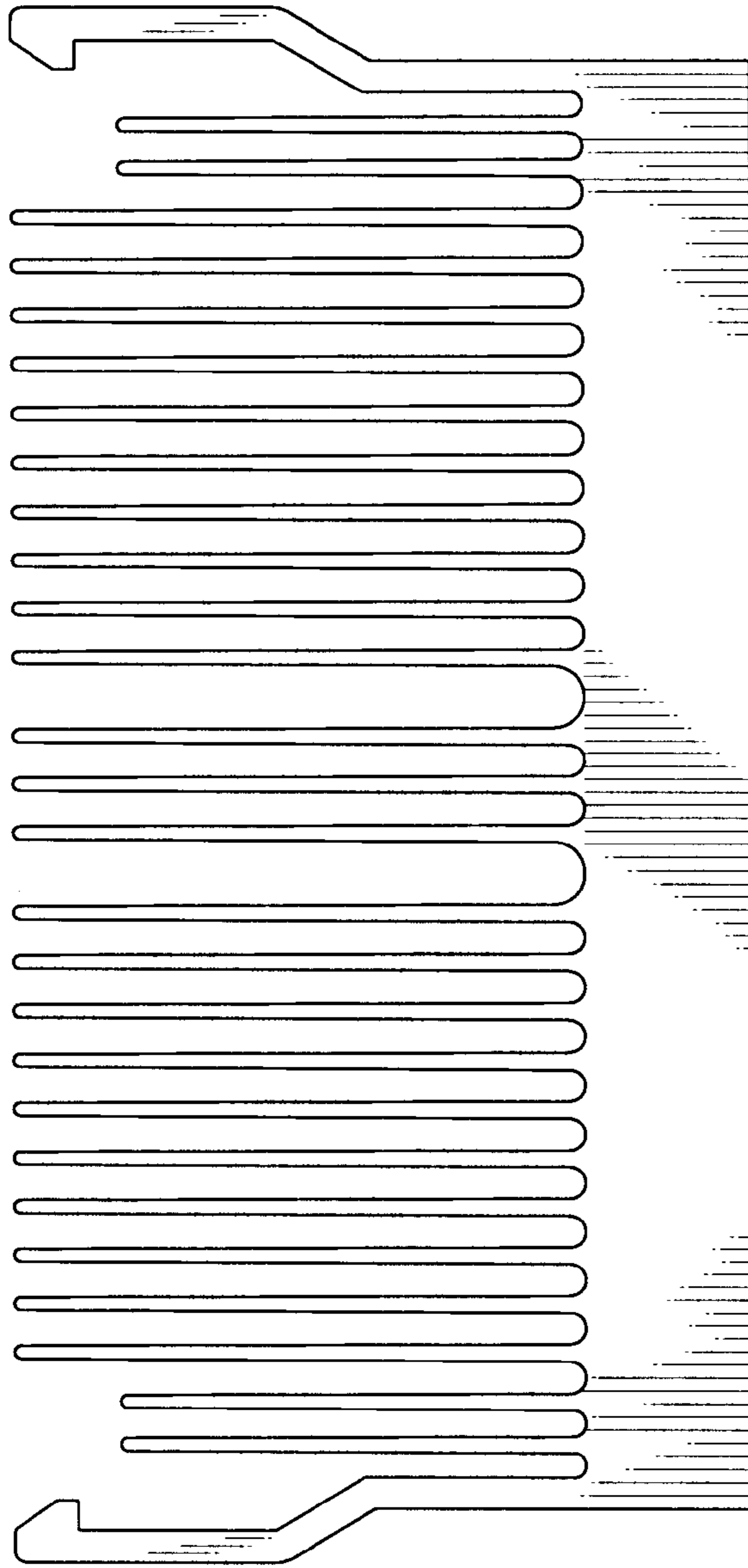

FIG. 4

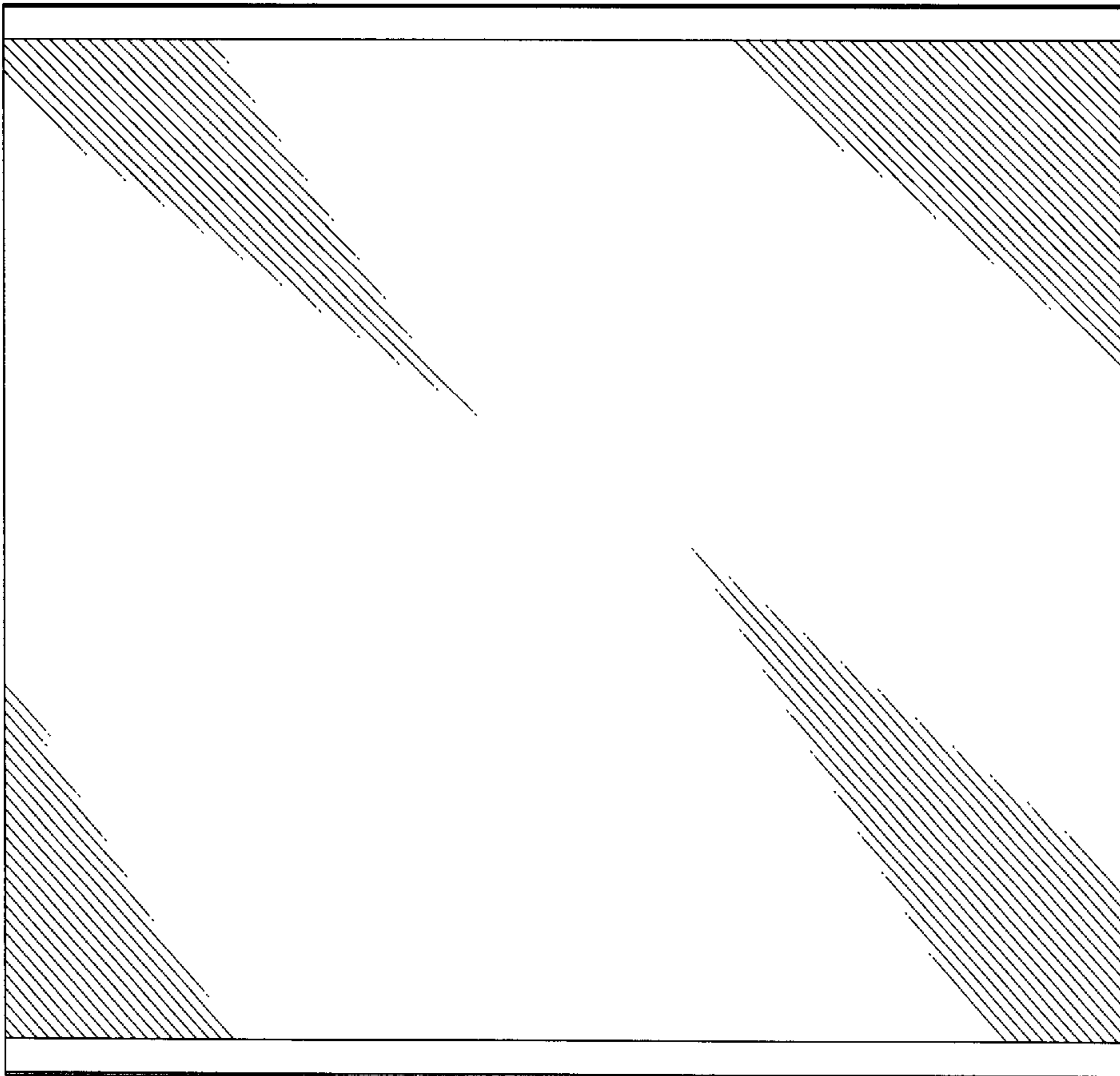

FIG. 5

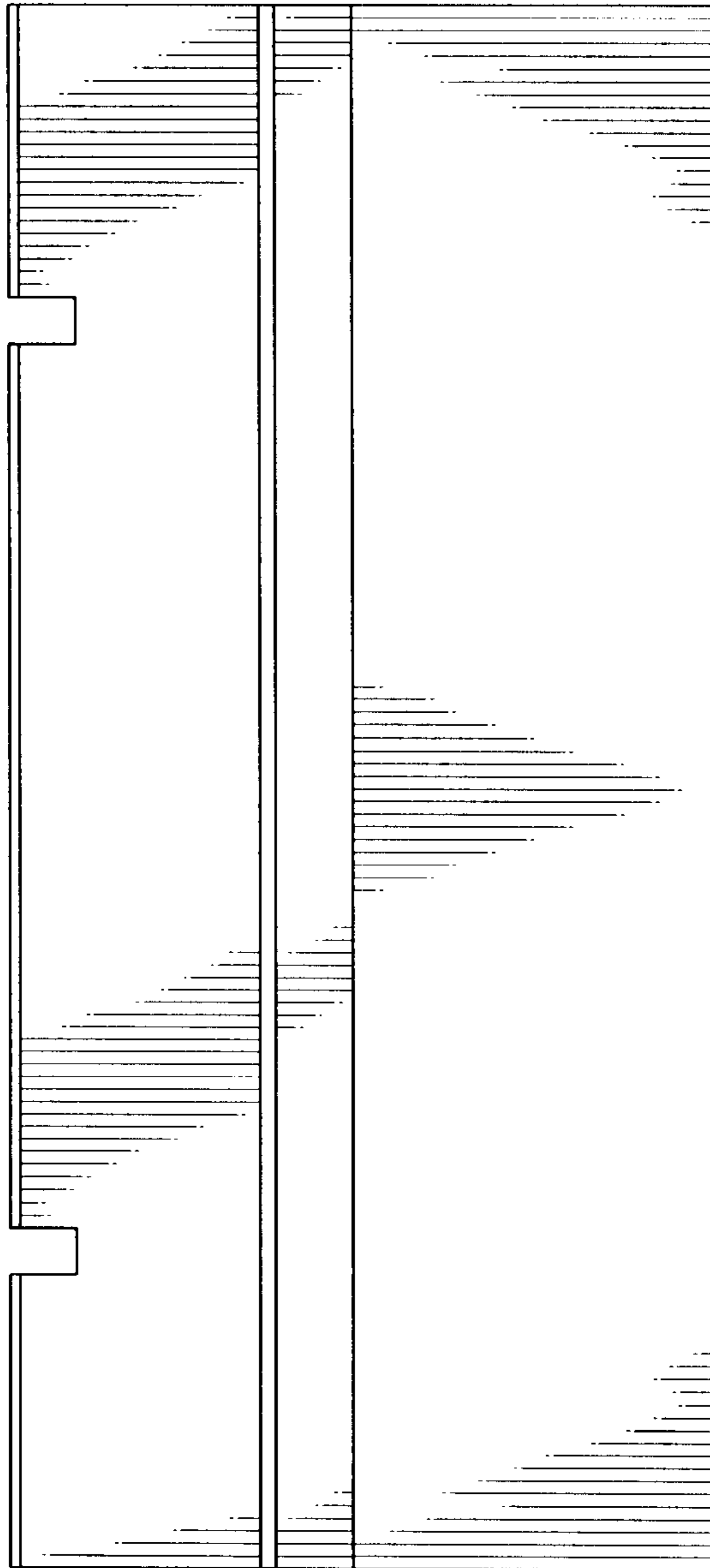

FIG. 6

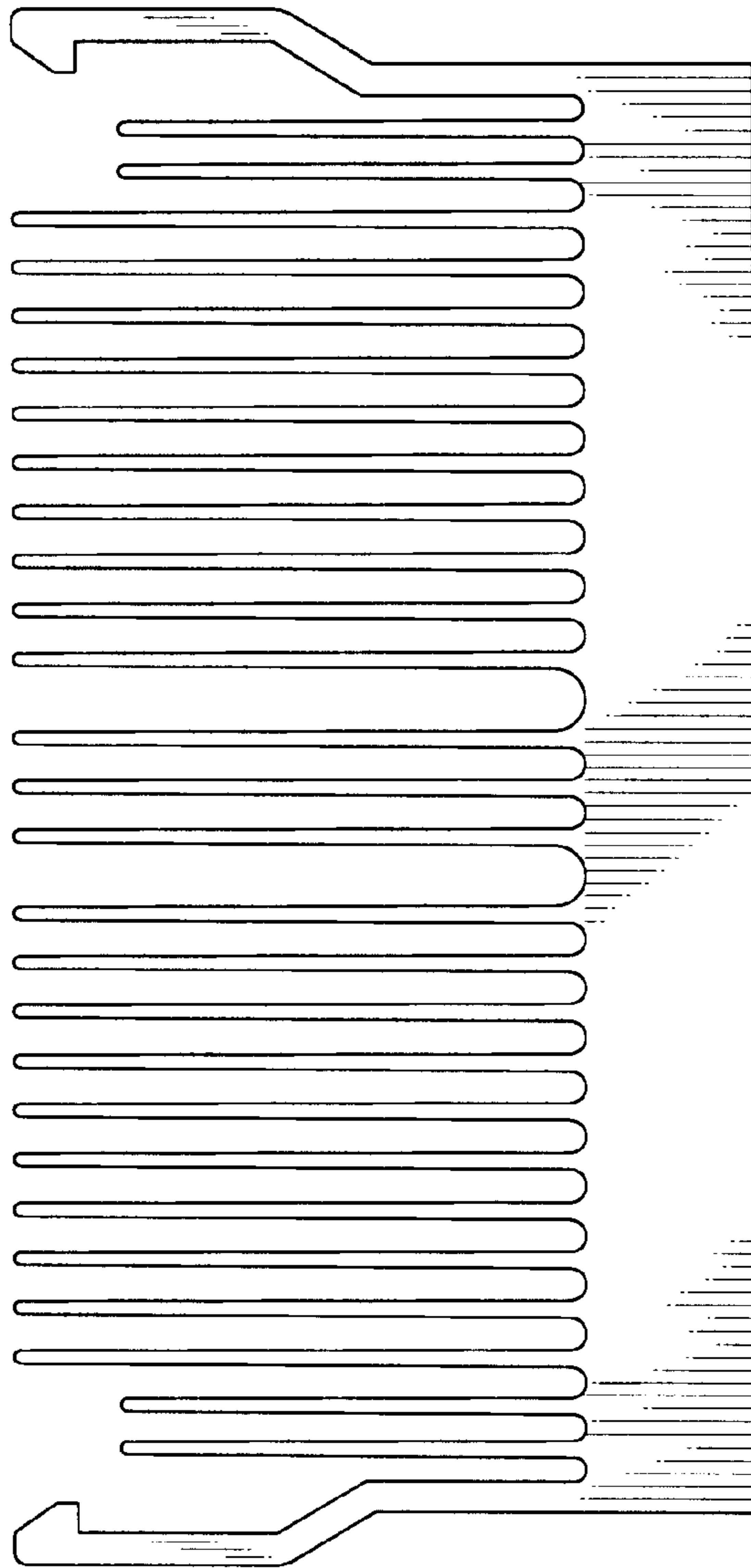

FIG. 7