



US00D480992S

(12) **United States Design Patent**
Lu

(10) **Patent No.:** **US D480,992 S**

(45) **Date of Patent:** **** Oct. 21, 2003**

(54) **SCOOTER**

(75) Inventor: **Cathy W. F. Lu**, Shanghai (CN)

(73) Assignee: **Dazon (Arizona) Incorporated**, Hong Kong (HK)

(**) Term: **14 Years**

(21) Appl. No.: **29/164,016**

(22) Filed: **Jul. 16, 2002**

(51) **LOC (7) Cl.** **12-11**

(52) **U.S. Cl.** **D12/110**

(58) **Field of Search** D12/110; 180/219,
180/220

(56) **References Cited**

U.S. PATENT DOCUMENTS

D307,119 S	*	4/1990	Yeh	D12/110
D314,166 S	*	1/1991	Shively et al.	D12/110
D331,553 S	*	12/1992	Agnolucci	D12/110
D361,741 S	*	8/1995	Sofue et al.	D12/110

OTHER PUBLICATIONS

Dazon *Diamondback 50 User manual*, pp. 1-47, undated, Tempe, Arizona.

Dazon, *Diamondback 50 brochure*, pp. 1-2, undated, Tempe, Arizona.

People's Motor International Group, *Diamondback 50 brochure*, pp. 1-2, undated, Hong Kong.

* cited by examiner

Primary Examiner—Alan P. Douglas

Assistant Examiner—Linda Brooks

(74) *Attorney, Agent, or Firm*—Snell & Wilmer

(57) **CLAIM**

The ornamental design for a scooter, as shown and described.

DESCRIPTION

FIG. 1 is a perspective view of a scooter showing an exemplary embodiment of our new design;

FIG. 2 is a front view of the scooter of FIG. 1;

FIG. 3 is a back view of the scooter of FIG. 1;

FIG. 4 is a right side view of the scooter of FIG. 1;

FIG. 5 is a left side view of the scooter of FIG. 1; and,

FIG. 6 is a top view of the scooter of FIG. 1.

The broken line showing of the license plate is for illustrative purposes only and forms no part of the claimed design.

1 Claim, 6 Drawing Sheets

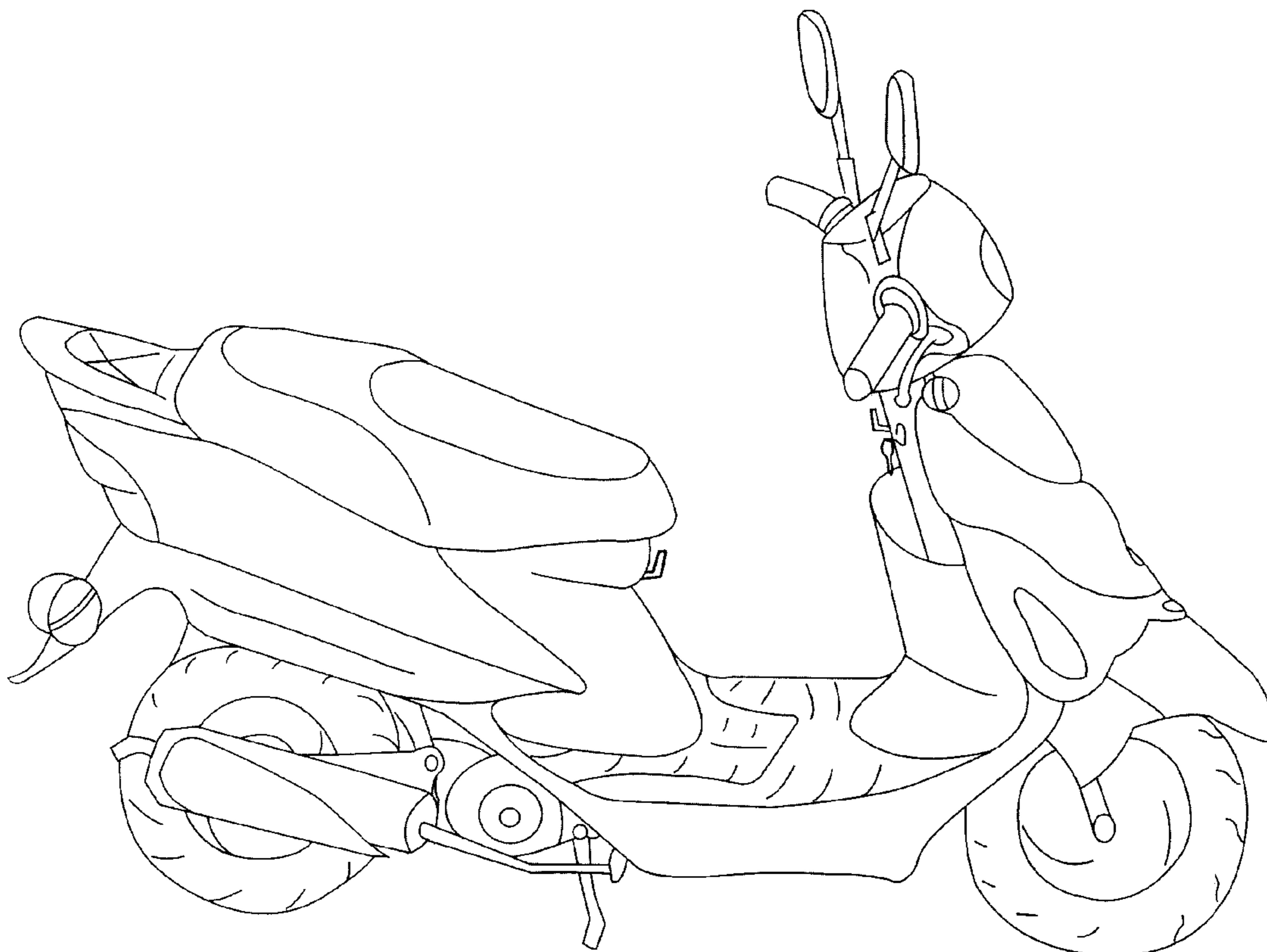

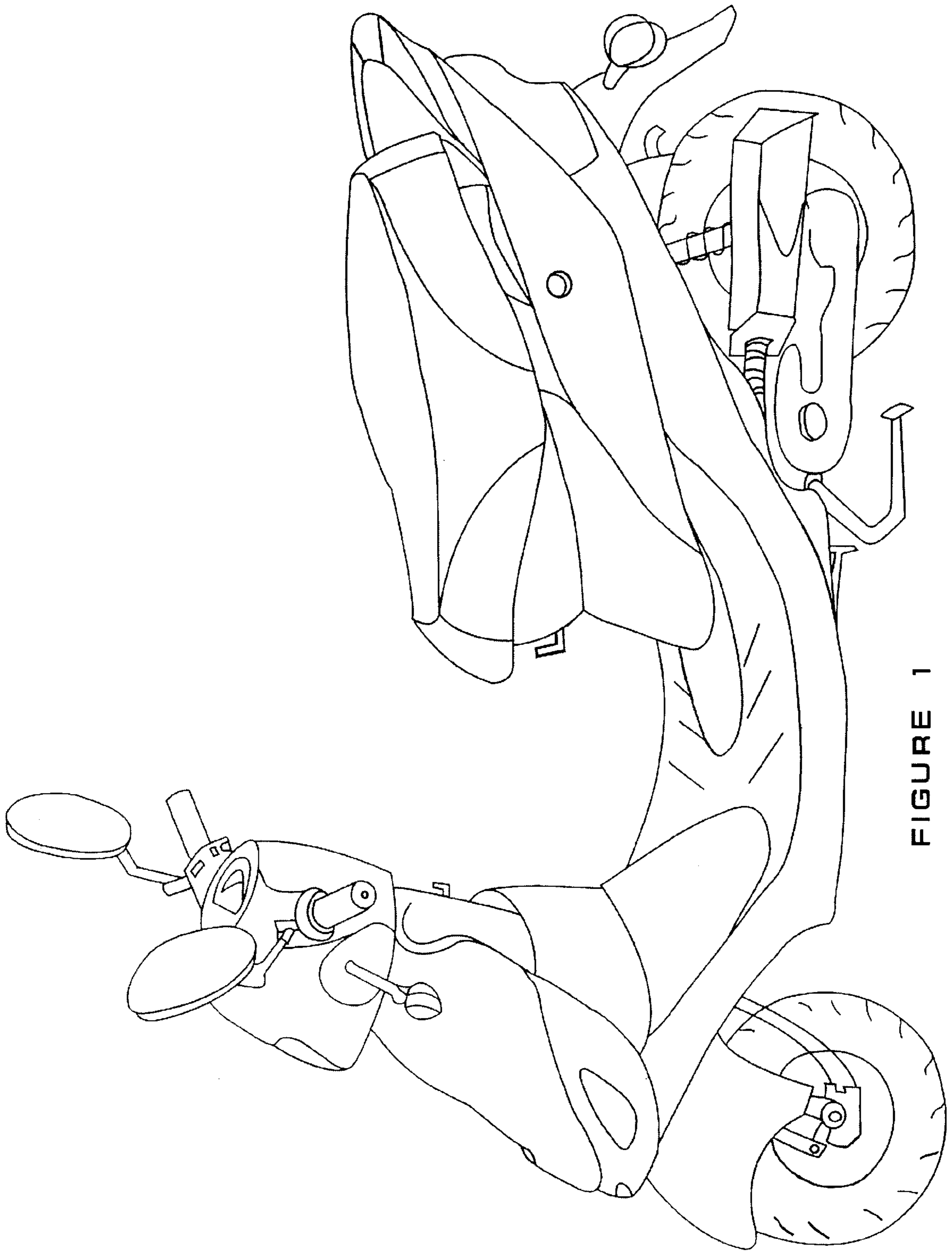

FIGURE 1

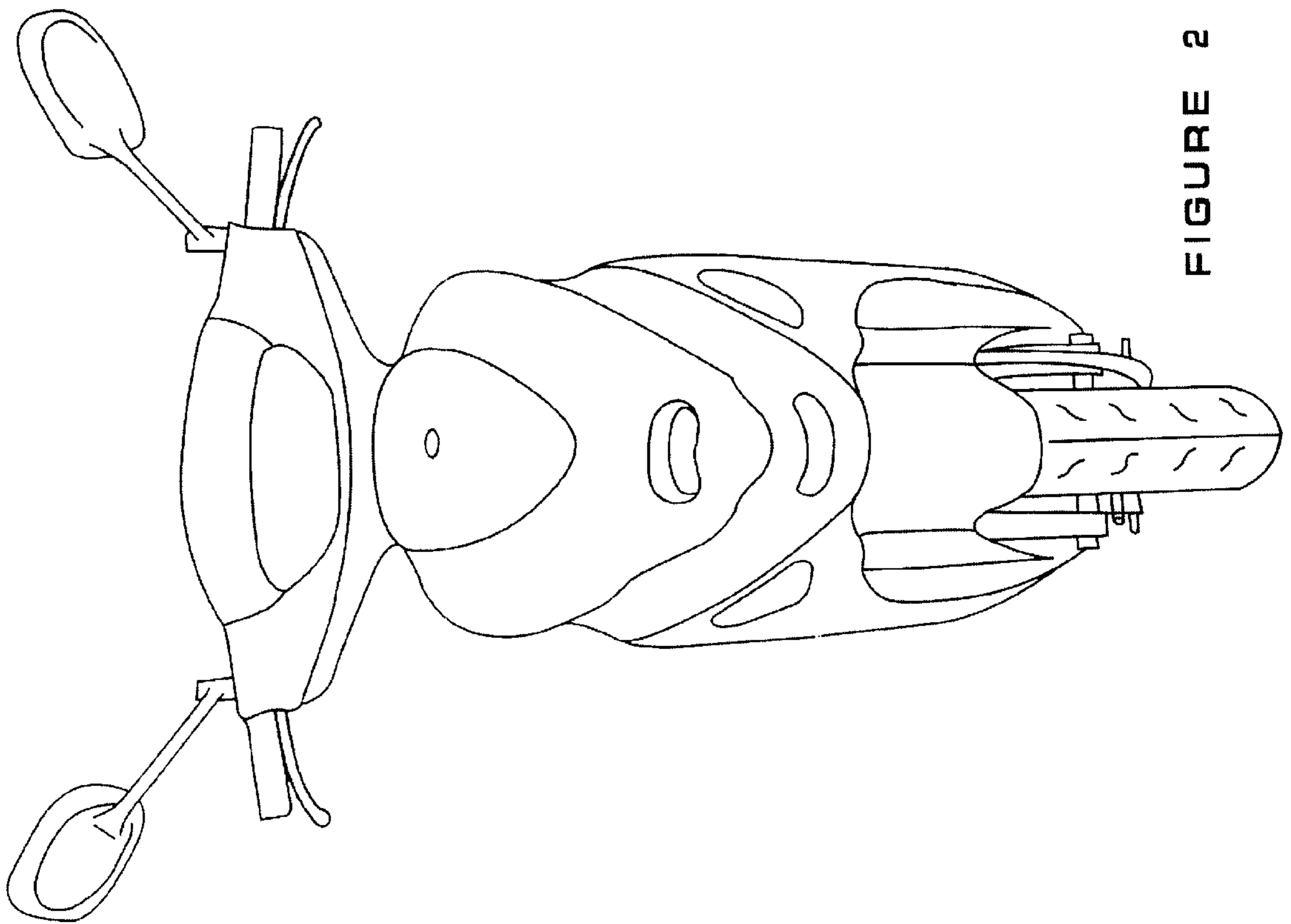

FIGURE 2

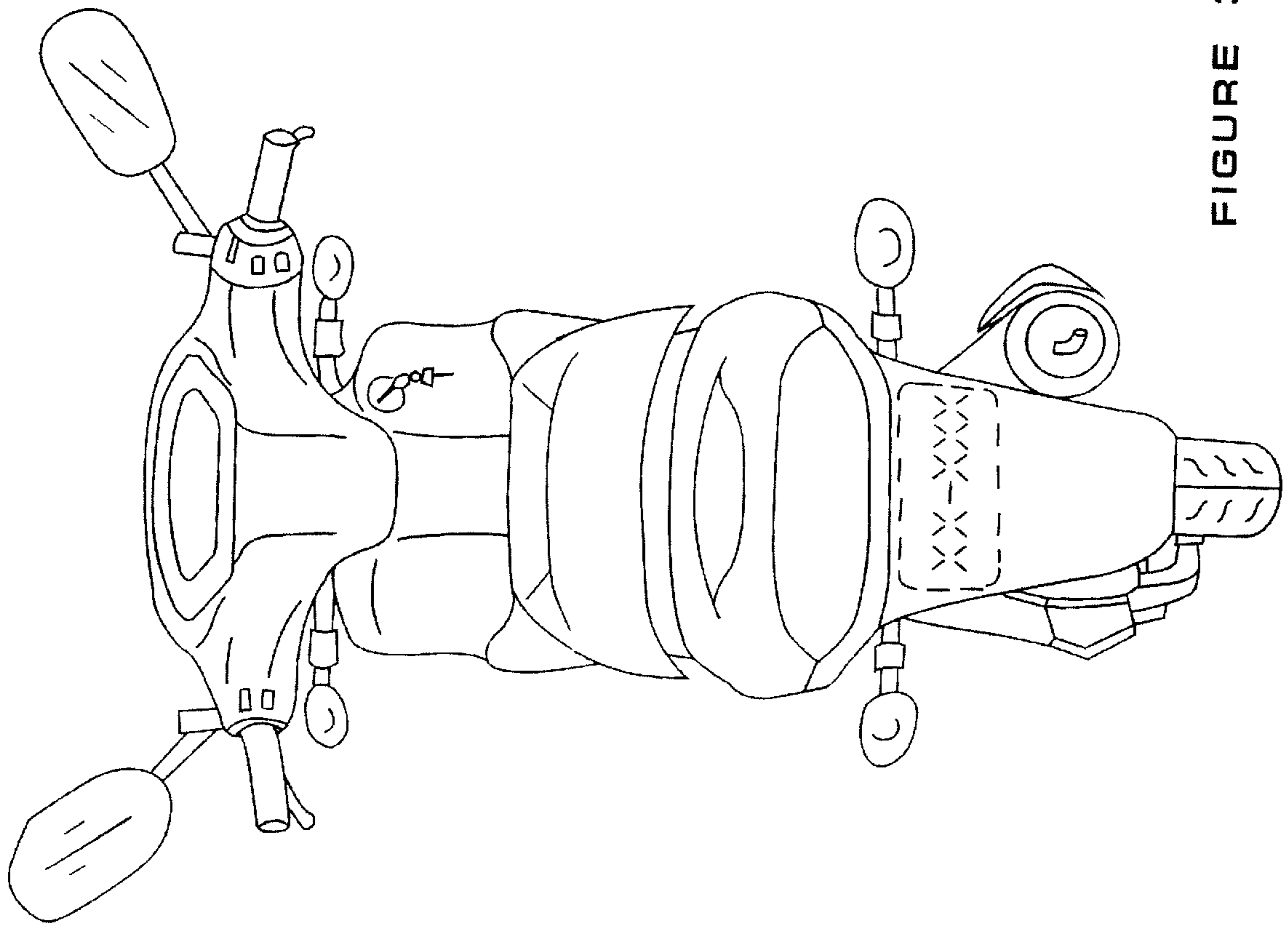

FIGURE 3

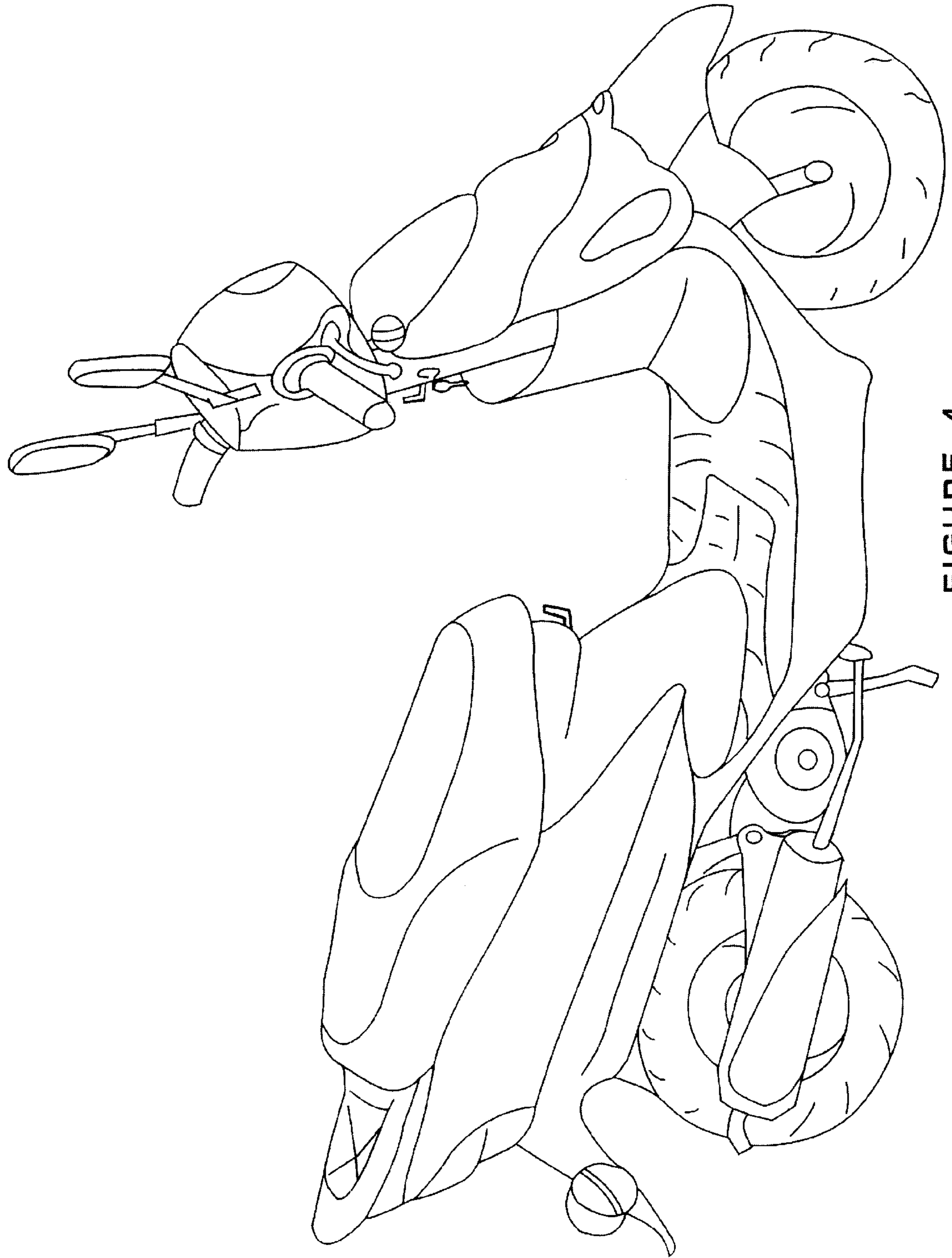

FIGURE 4

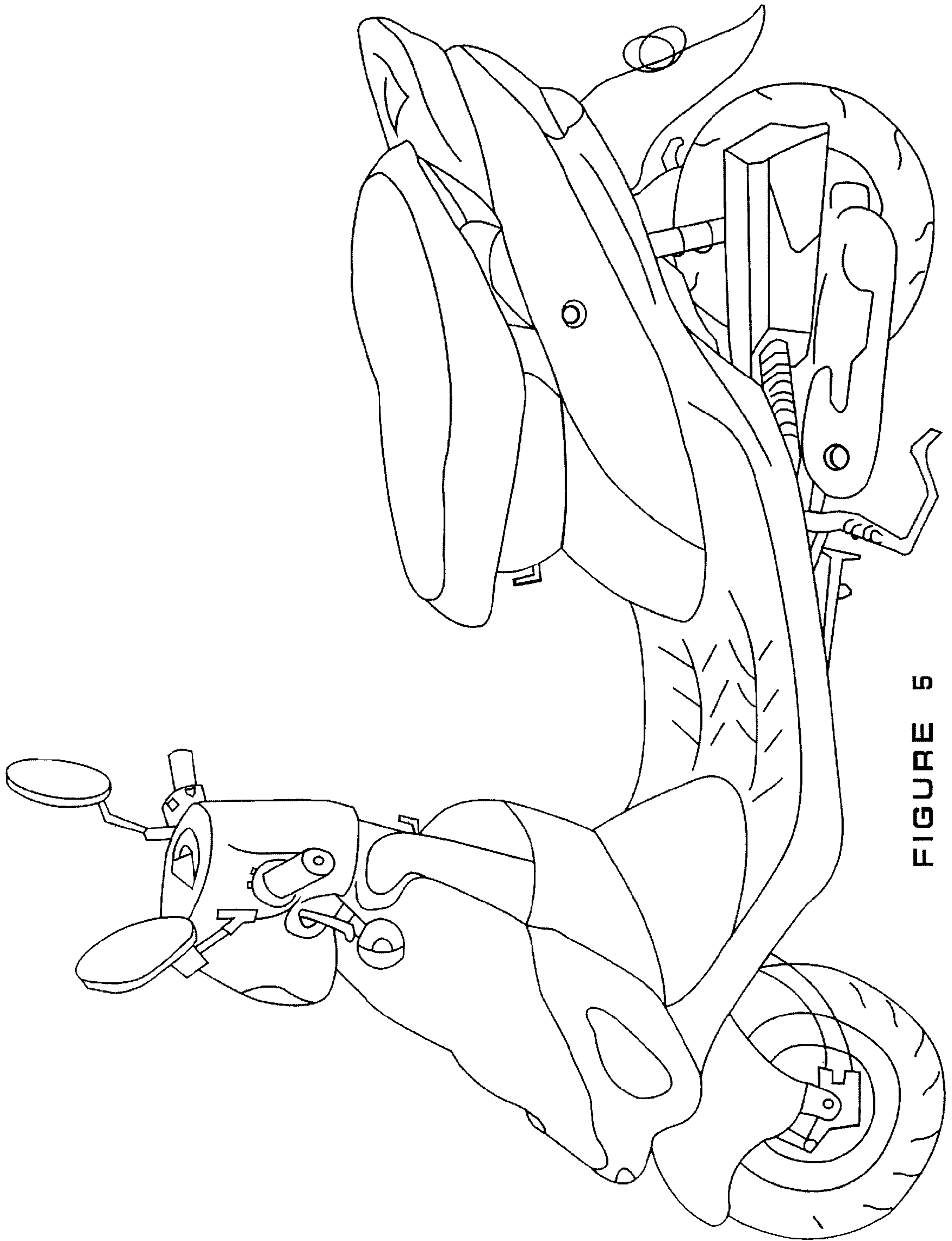

FIGURE 5

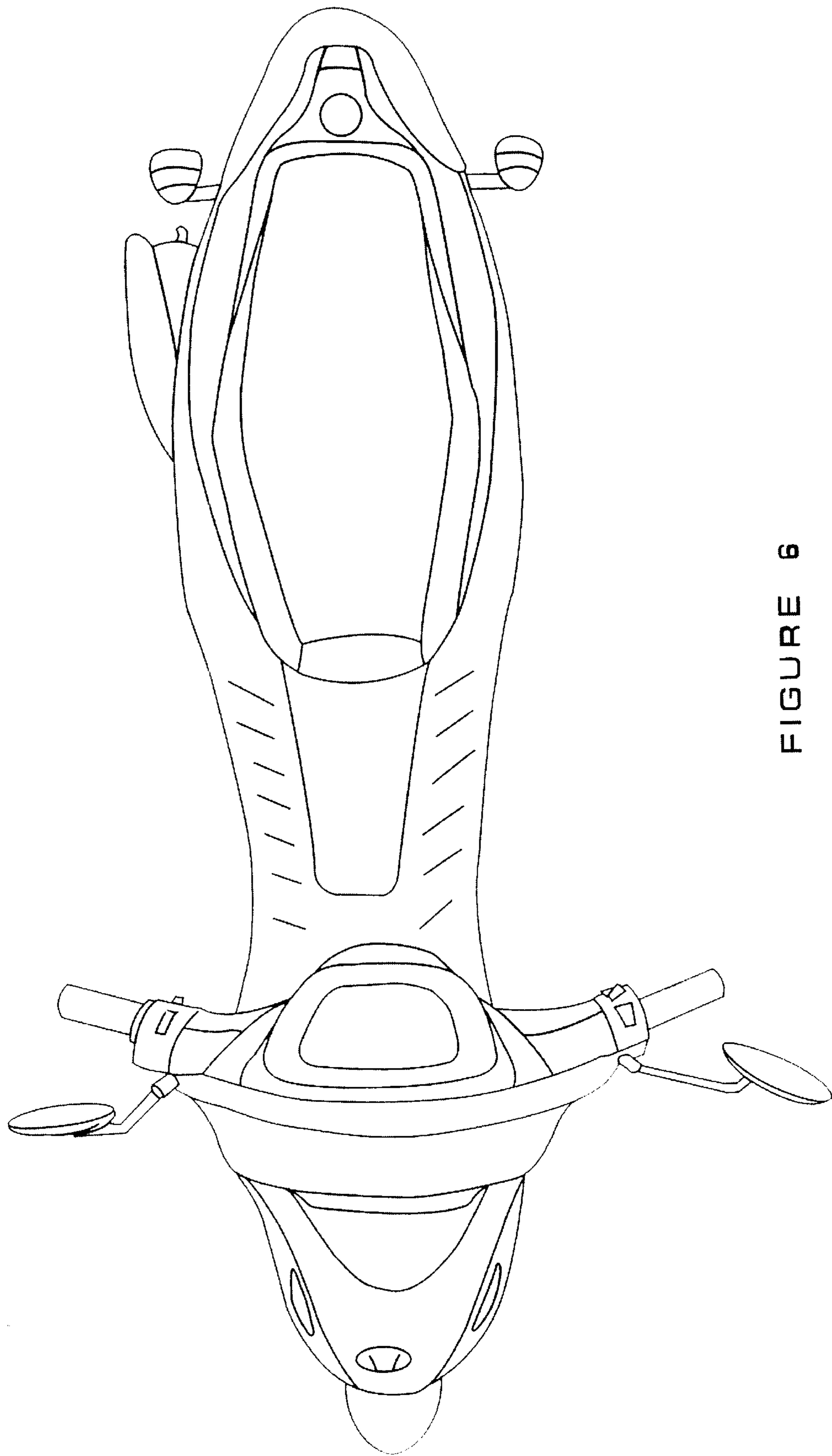

FIGURE 6