



US00D480923S

(12) **United States Design Patent**
Neubourg

(10) **Patent No.:** **US D480,923 S**

(45) **Date of Patent:** **** Oct. 21, 2003**

(54) **TRAY**

(75) Inventor: **Wouter De Neubourg**, Berchem (BE)

(73) Assignee: **DeSter.ACS Holding B.V.**, Weesp (NL)

(**) Term: **14 Years**

(21) Appl. No.: **29/146,846**

(22) Filed: **Aug. 20, 2001**

(30) **Foreign Application Priority Data**

Feb. 20, 2001 (DE) 4 01 01 666

(51) **LOC (7) Cl.** **07-01**

(52) **U.S. Cl.** **D7/554.3**

(58) **Field of Search** D7/550.1, 551.2,
D7/552.1, 552.2, 553.2, 553.7, 554.3, 554.4,
555, 586; D9/414, 424, 425, 434, 456,
459; 206/557.1; 220/574; D19/35; D80/119

(56) **References Cited**

U.S. PATENT DOCUMENTS

- D160,480 S * 10/1950 Crook D7/551.2
- D216,531 S * 2/1970 Stone D7/586
- D240,714 S * 7/1976 White D9/425
- D277,295 S * 1/1985 Jones D19/35
- D384,778 S * 10/1997 Powers et al. D30/119
- D440,117 S * 4/2001 Claffy et al. D7/550.1

* cited by examiner

Primary Examiner—Charles A. Rademaker

(74) *Attorney, Agent, or Firm*—Shlesinger, Arkwright & Garvey LLP

(57) **CLAIM**

The ornamental design for the tray, as shown and described.

DESCRIPTION

FIG. 1 is a top perspective view of a tray showing a first preferred embodiment of my design;
 FIG. 2 is a front side view of the tray of FIG. 1, the rear side view being a mirror image thereof;
 FIG. 3 is a right side view of the tray of FIG. 1, the left side view being a mirror image thereof;
 FIG. 4 is a top view of the tray of FIG. 1;
 FIG. 5 is a bottom view of the tray of FIG. 1;
 FIG. 6 is a top perspective view of a tray showing a further preferred embodiment of my design;
 FIG. 7 is a front side view of the tray of FIG. 6, the rear side view being a mirror image thereof;
 FIG. 8 is a right side view of the tray of FIG. 6, the left side view being a mirror image thereof;
 FIG. 9 is a top view of the tray of FIG. 6;
 FIG. 10 is a bottom view of the tray of FIG. 6;
 FIG. 11 is a top perspective view of a tray showing a still further preferred embodiment of my design;
 FIG. 12 is a front side view of the tray of FIG. 11, the rear side view being a mirror image thereof;
 FIG. 13 is a right side view of the tray of FIG. 11, the left side view being a mirror image thereof;
 FIG. 14 is a top view of the tray of FIG. 11; and,
 FIG. 15 is a bottom view of the tray of FIG. 11.

1 Claim, 6 Drawing Sheets

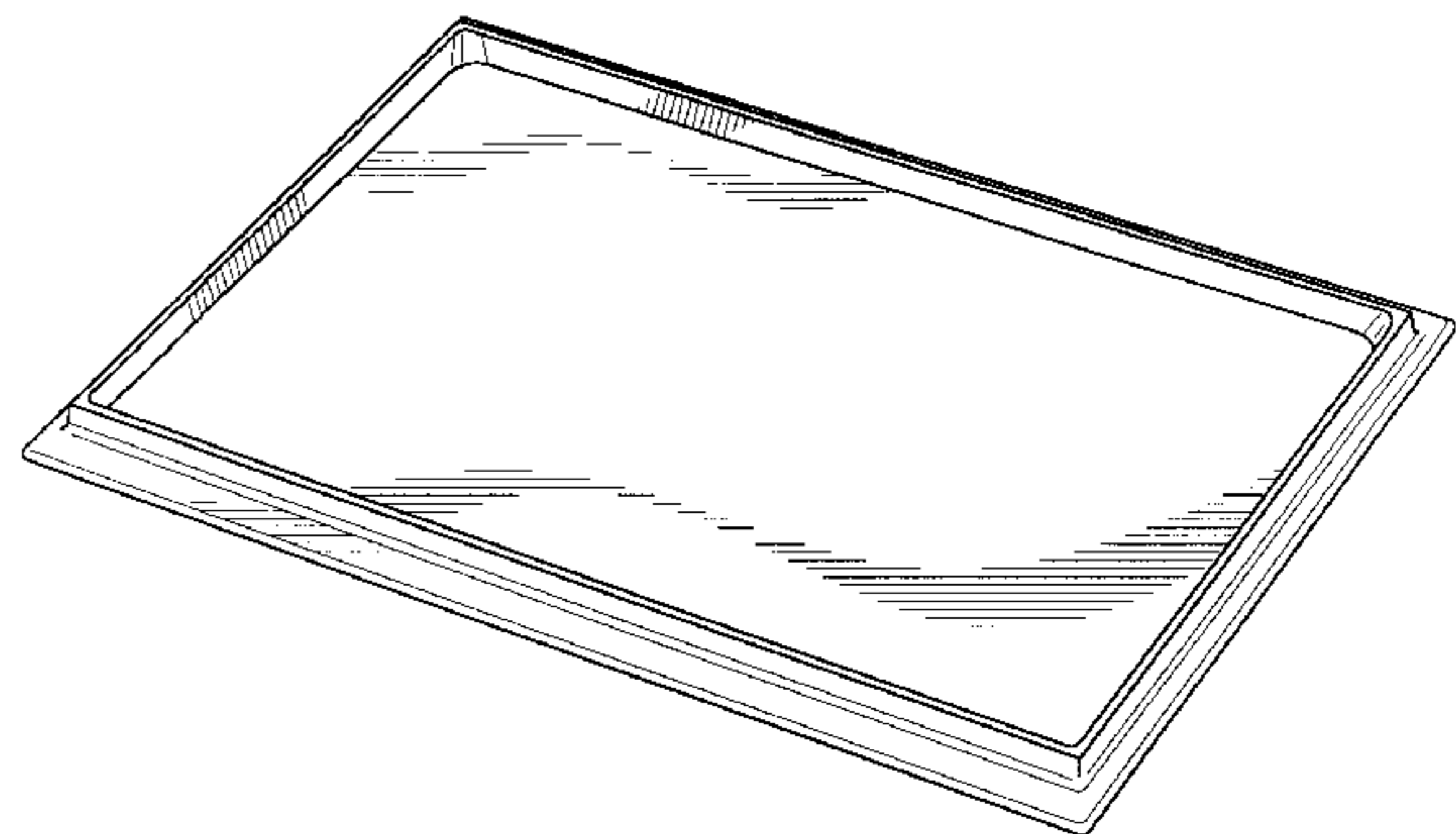
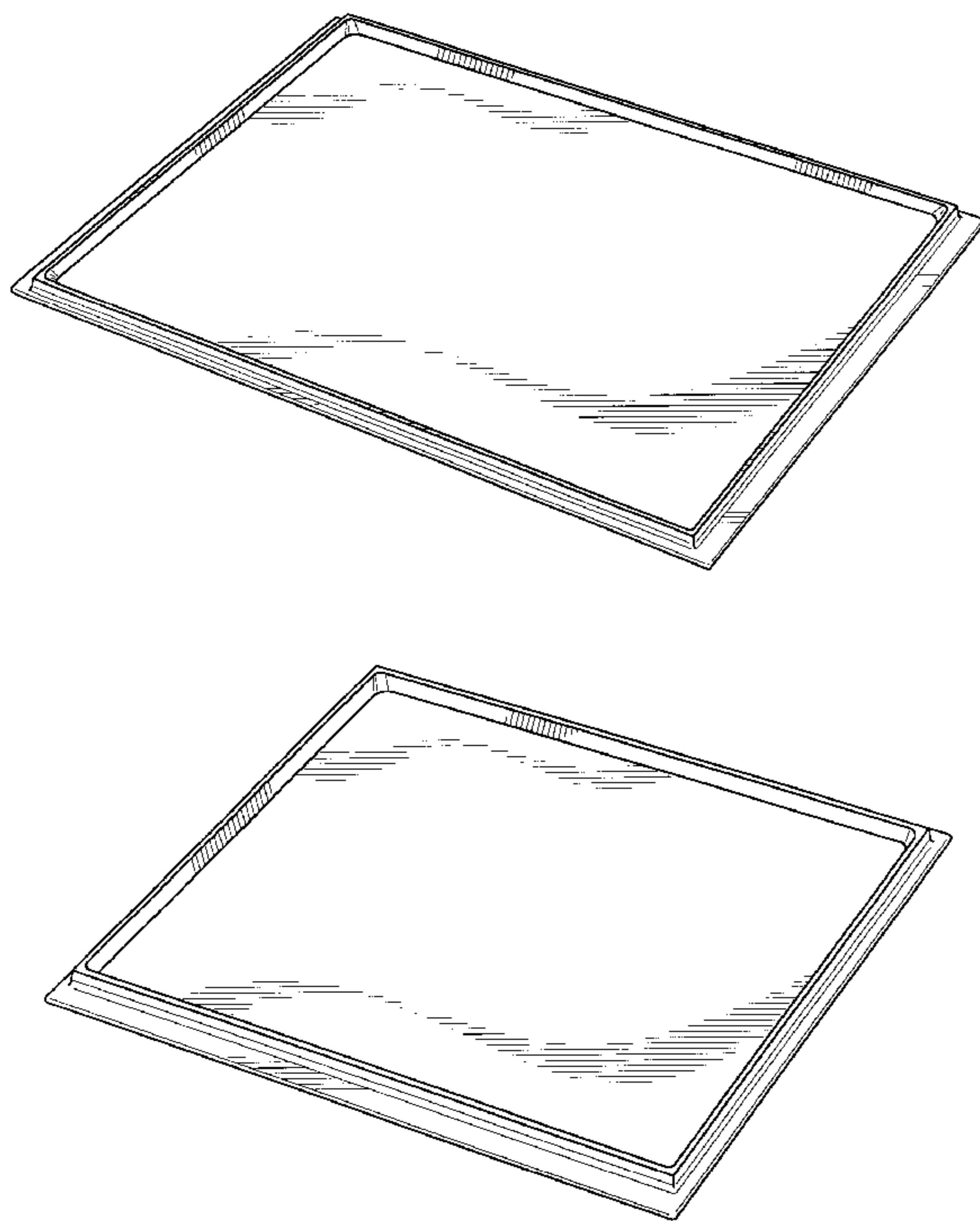

FIG. 1

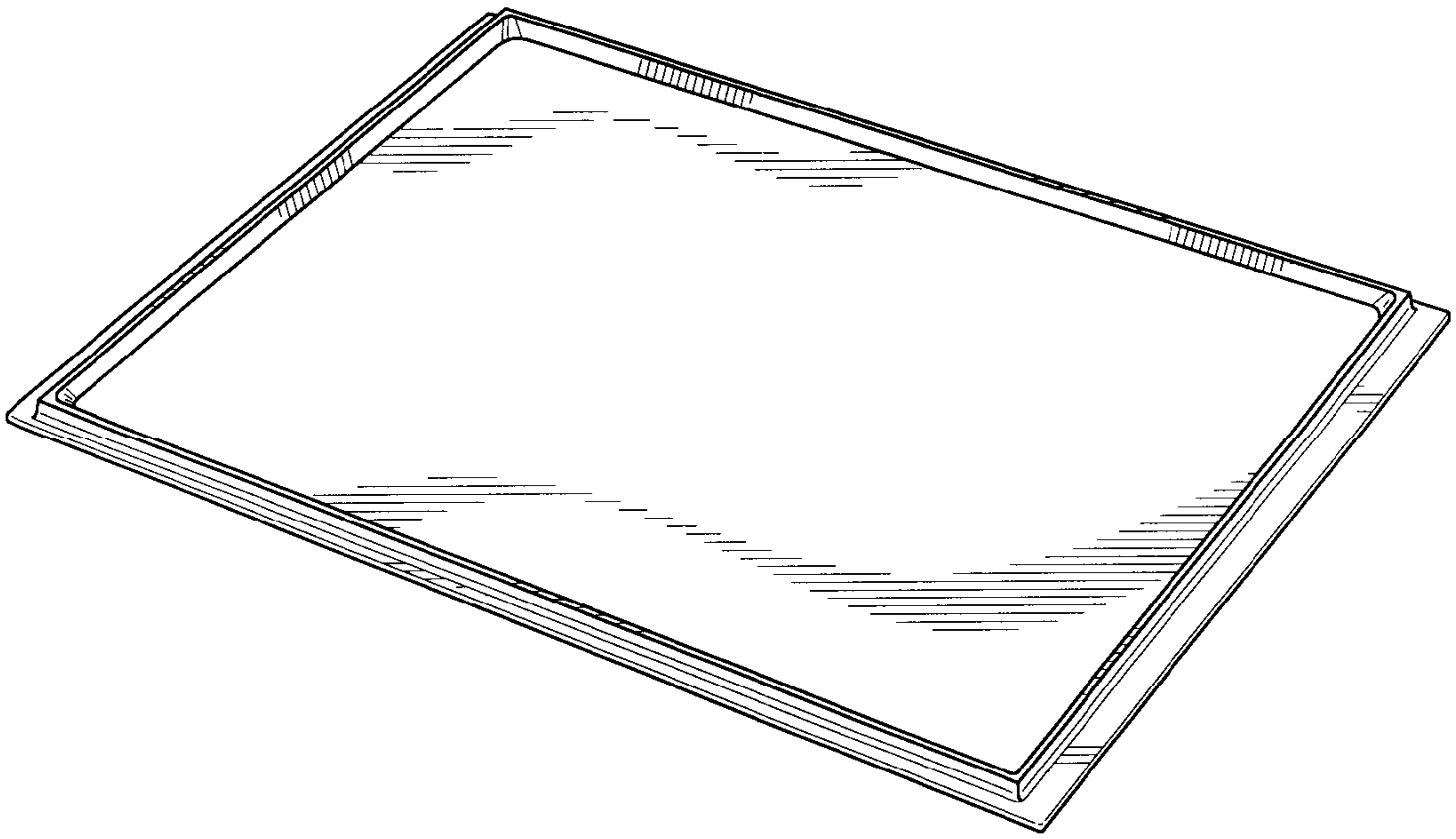
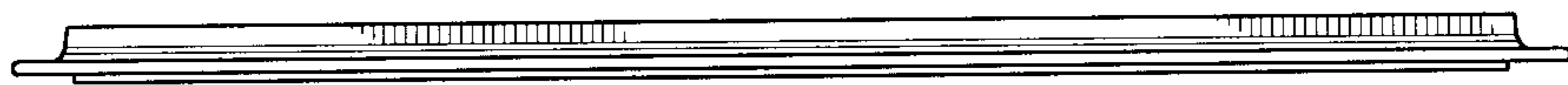

FIG. 2



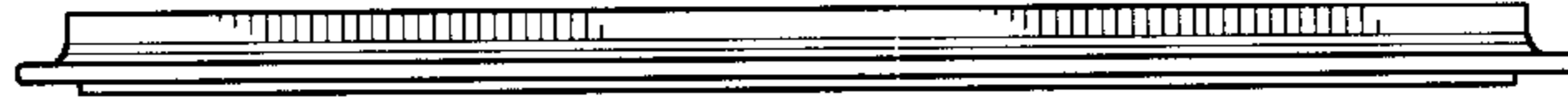

FIG.3

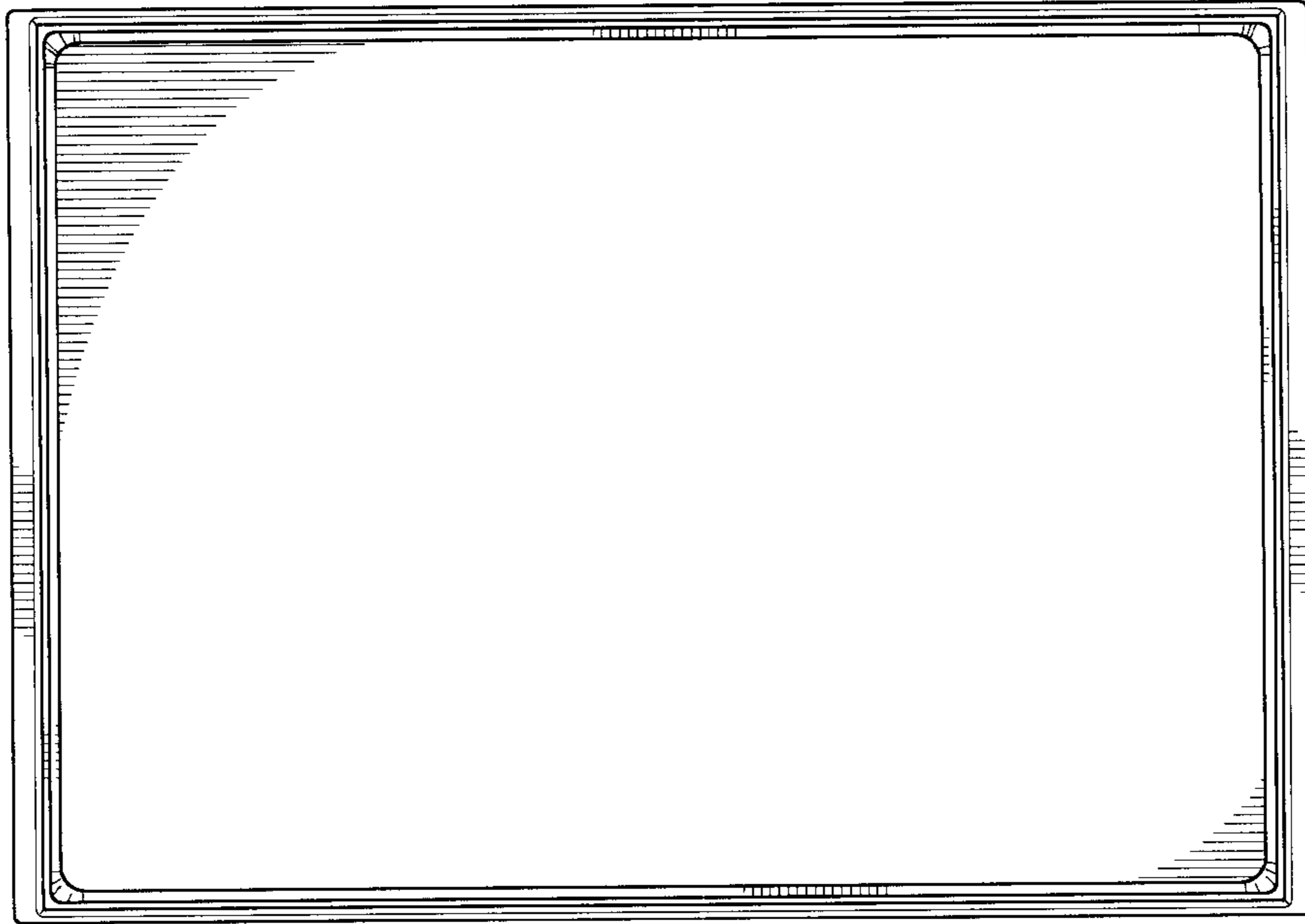

FIG.4

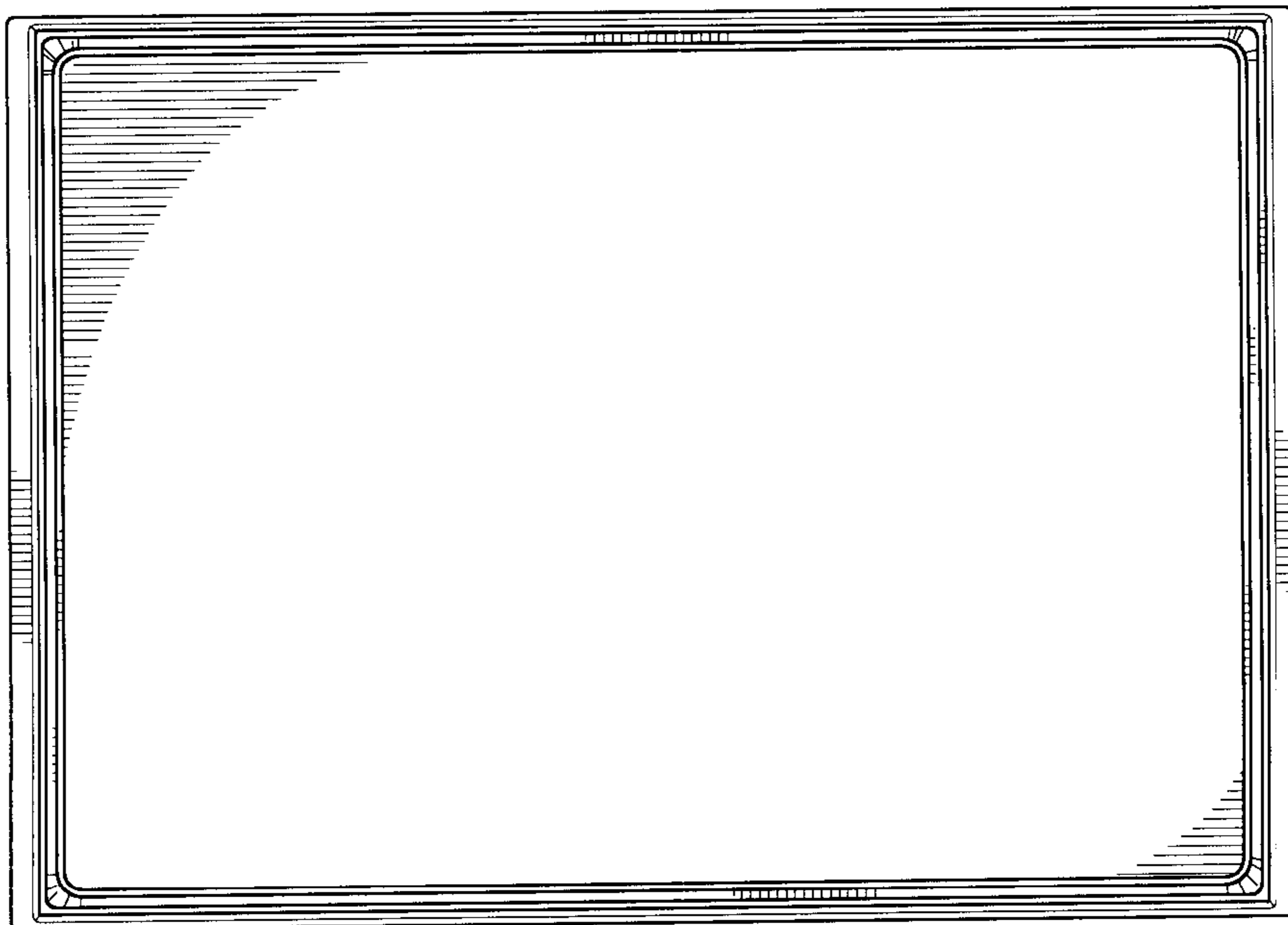

FIG.5

FIG.6

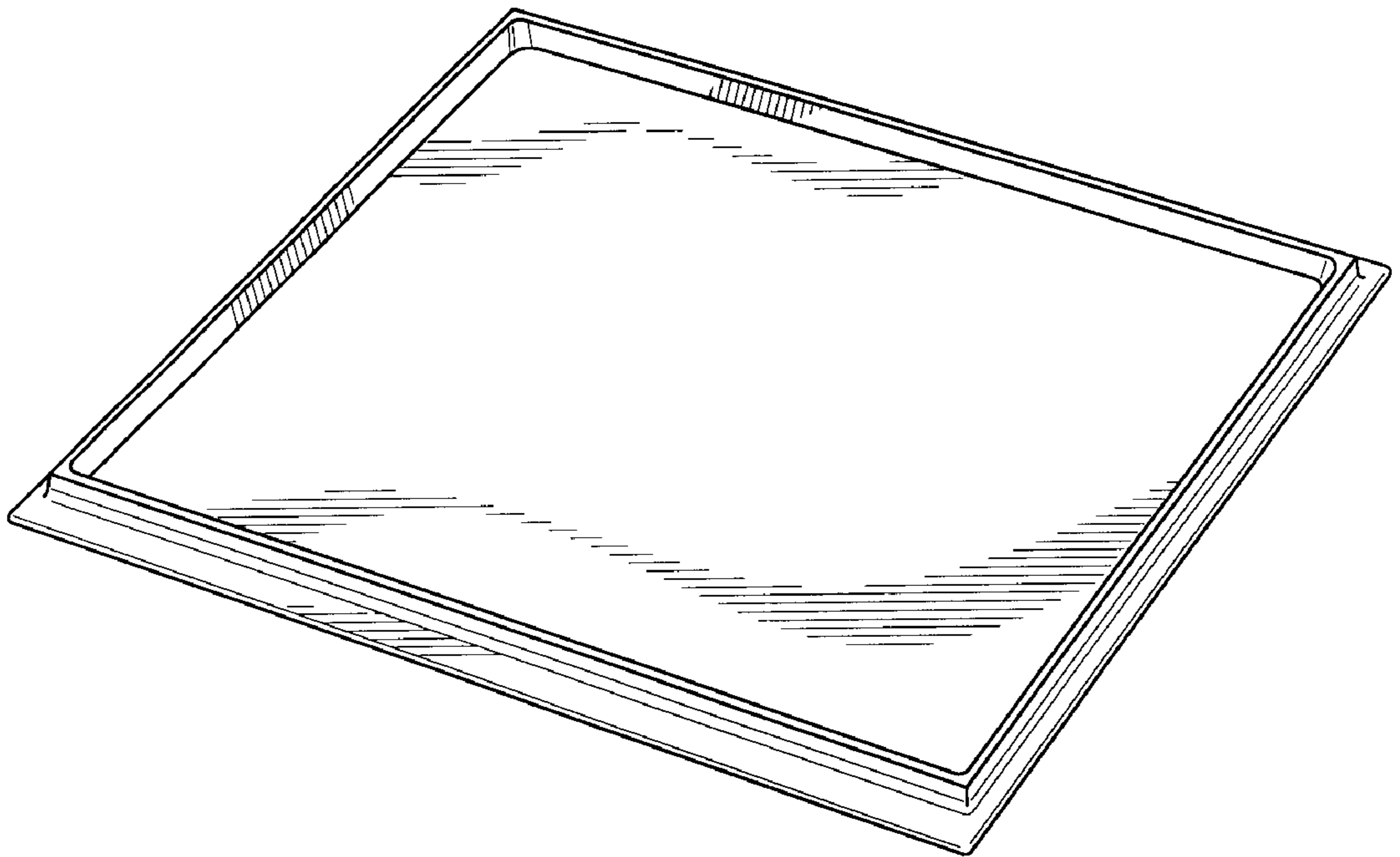
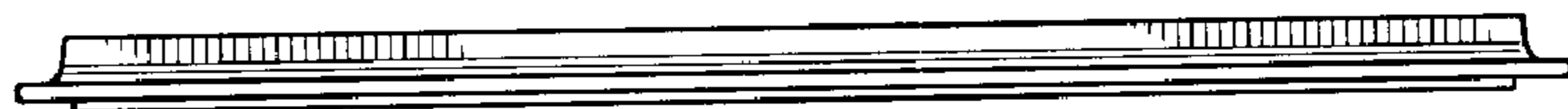

FIG.7



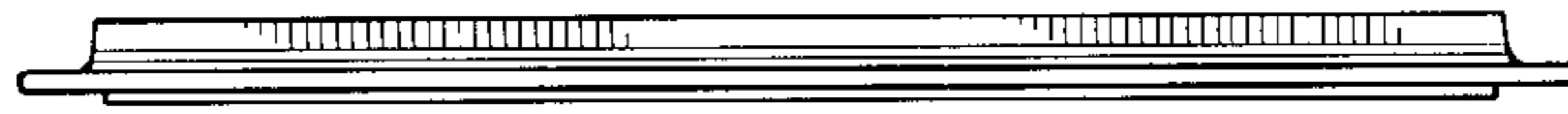

FIG. 8

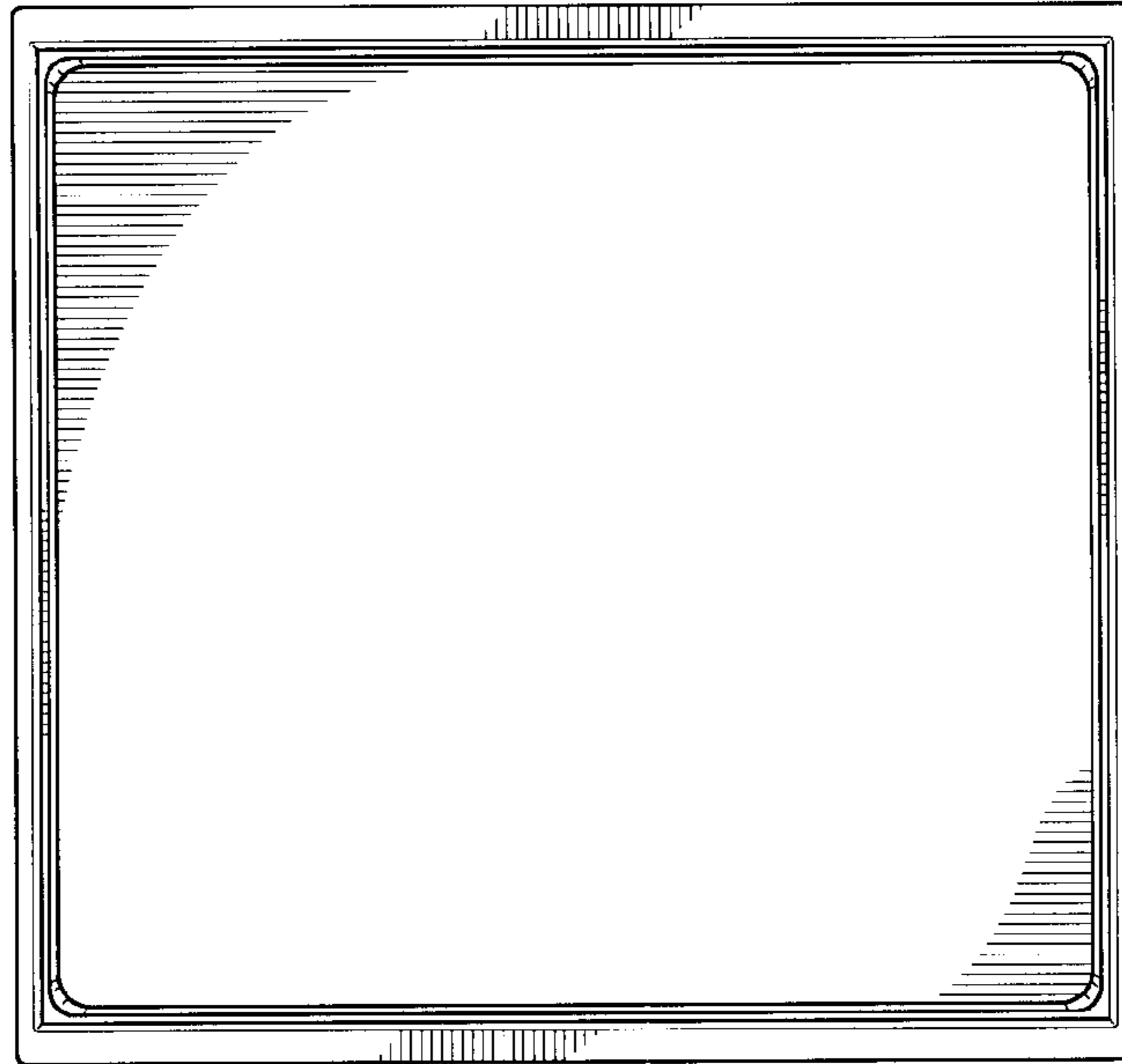

FIG. 9

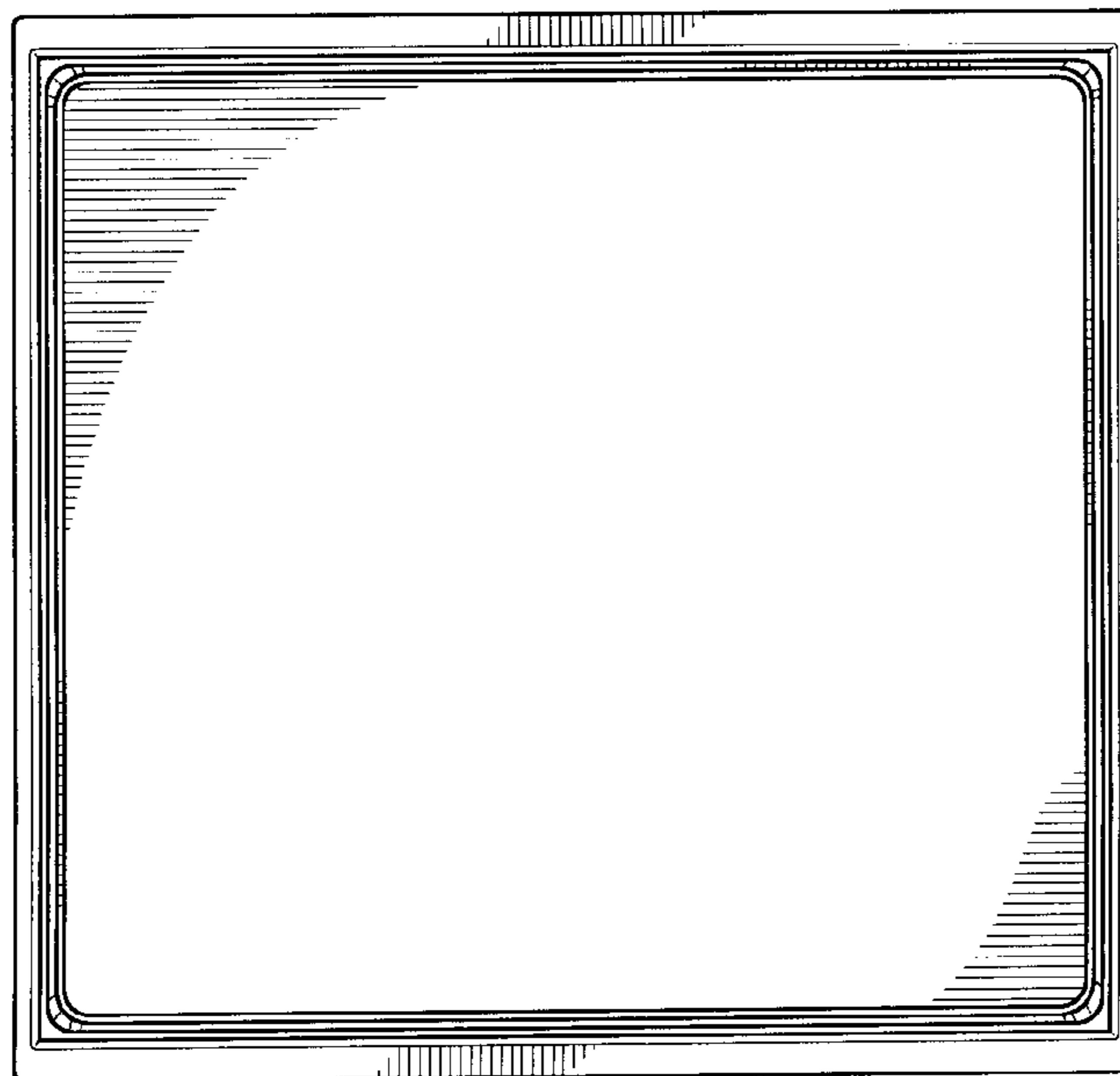

FIG. 10

FIG.11

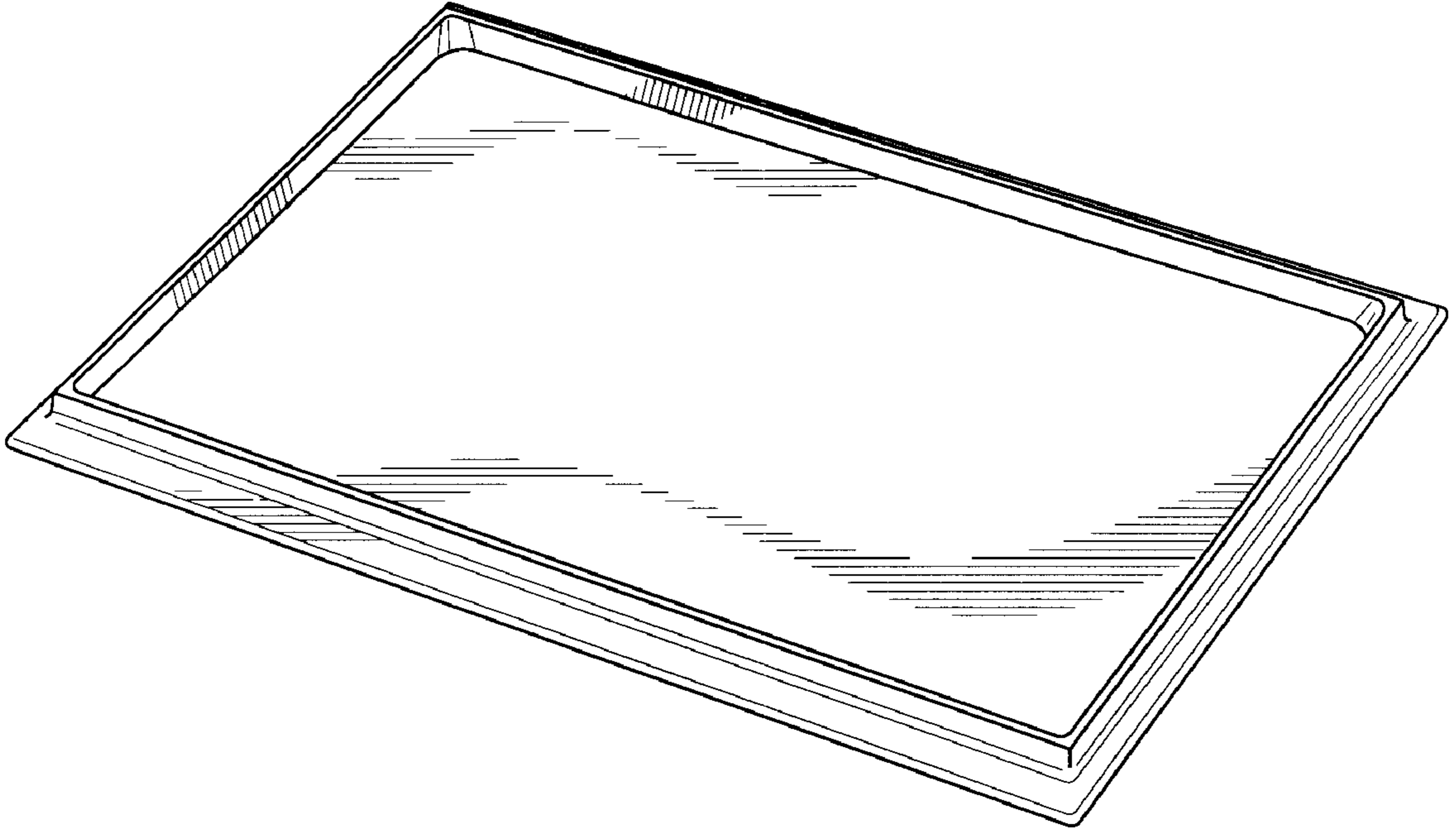
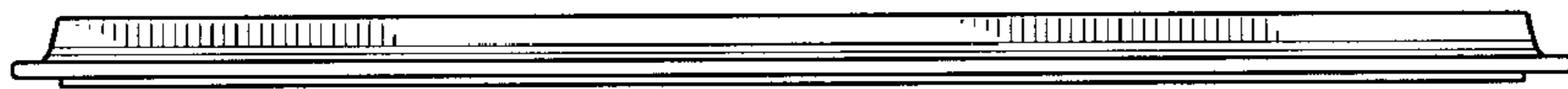

FIG.12



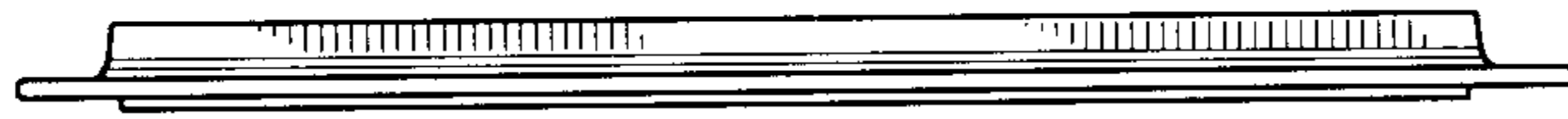

FIG.13

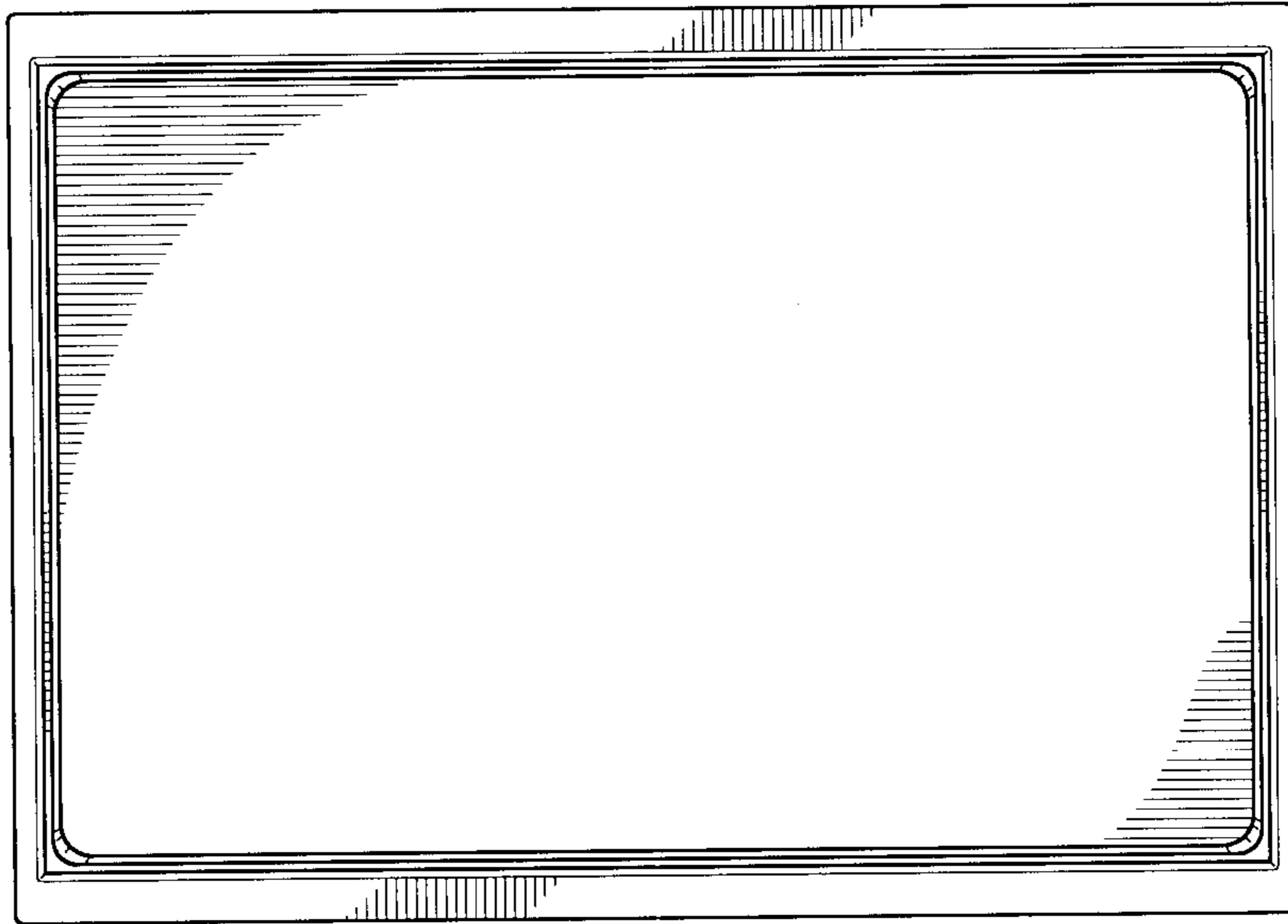

FIG.14

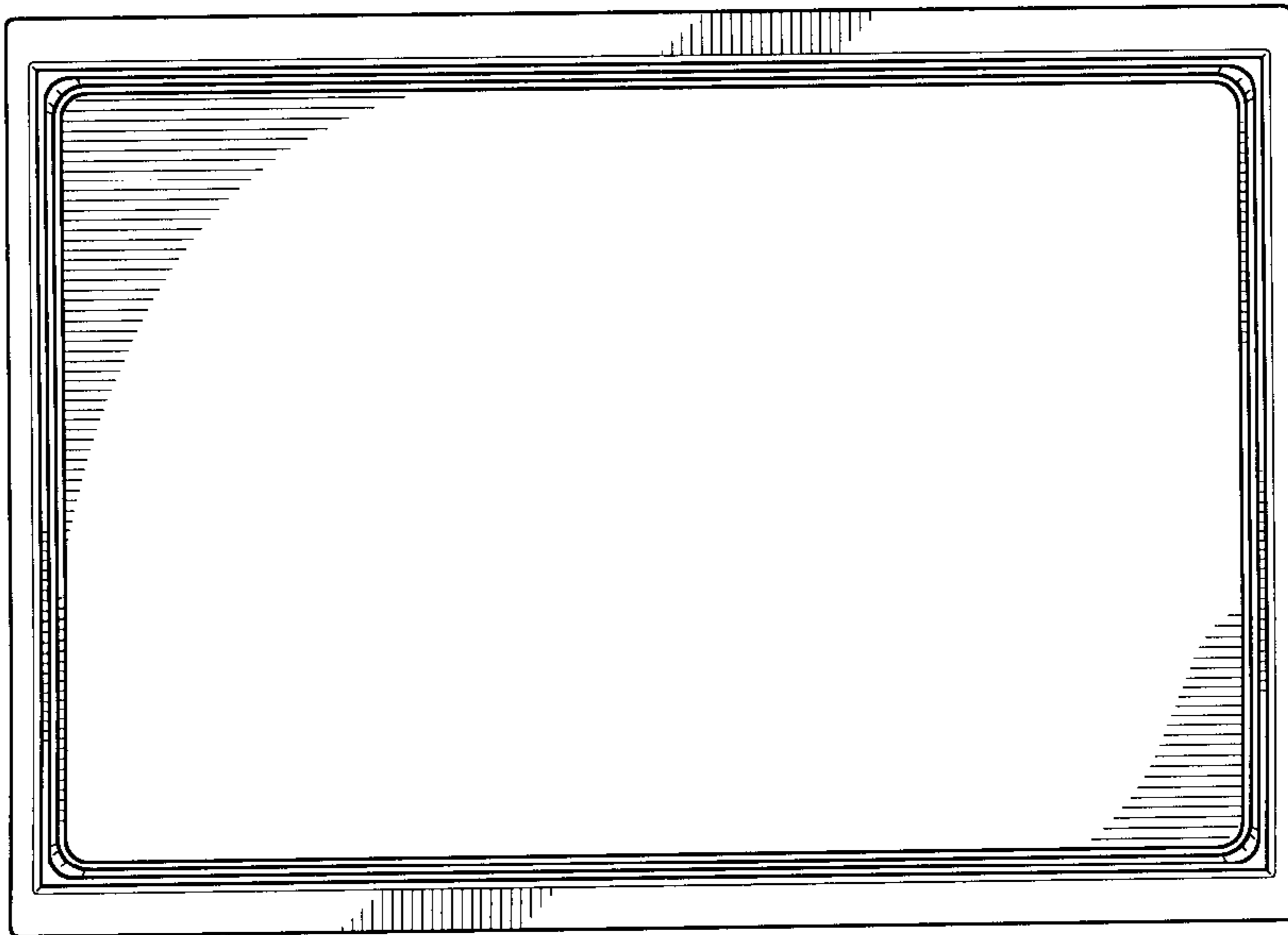

FIG.15