



US00D480715S

(12) **United States Design Patent**
Pietola

(10) **Patent No.:** **US D480,715 S**

(45) **Date of Patent:** **** Oct. 14, 2003**

(54) **ACCESS POINT**

(75) Inventor: **Paavo Pietola, Helsinki (FI)**

(73) Assignee: **Nokia Corporation, Espoo (FI)**

(**) Term: **14 Years**

(21) Appl. No.: **29/154,263**

(22) Filed: **Jan. 15, 2002**

(30) **Foreign Application Priority Data**

Oct. 16, 2001 (FI) M20010694

(51) **LOC (7) Cl.** **14-03**

(52) **U.S. Cl.** **D14/240**

(58) **Field of Search** D14/137, 240,
D14/138, 242, 308, 356, 357, 358, 311,
313, 441, 144, 348-355, 370, 341-347,
125, 432, 433, 155, 299, 257, 439, 140,
188, 230, 241, 243, 245; 379/433.01-433.13,
419, 434, 428.01-428.04, 420.01-420.04,
440, 441, 442; 455/550-575, 90; D13/184,
123, 152, 147, 110, 164; 200/296, 293;
361/600, 622, 684, 724-728, 702

(56) **References Cited**

U.S. PATENT DOCUMENTS

D263,957 S * 4/1982 Pemberton D14/356
D275,101 S * 8/1984 Read D14/240
D327,887 S * 7/1992 Pushelberg et al. D14/140
D330,890 S * 11/1992 Loew D14/100
D367,859 S * 3/1996 Beaumont et al. D14/142
D372,474 S * 8/1996 Ford et al. D14/149
D379,993 S * 6/1997 Devitt et al. D14/240
D390,217 S * 2/1998 Prstojevich et al. D14/125
D390,570 S * 2/1998 Read D14/240

D392,645 S * 3/1998 Wakabayashi D14/240
D392,966 S * 3/1998 Lee et al. D14/135
D411,535 S * 6/1999 Beaumont et al. D14/137
D413,578 S * 9/1999 Larson et al. D13/152
D414,186 S * 9/1999 Hogenbirk D14/217
D418,822 S * 1/2000 Worley et al. D14/356
D438,197 S * 2/2001 Arpe D14/240
D446,207 S * 8/2001 Matthes et al. D14/299
6,328,612 B1 * 12/2001 Chung 439/717
D464,045 S * 10/2002 Bohne D14/240
D464,643 S * 10/2002 Hill et al. D14/240

* cited by examiner

Primary Examiner—Jeffrey Asch

(74) *Attorney, Agent, or Firm*—Darby & Darby

(57) **CLAIM**

The ornamental design for an access point, as shown and described.

DESCRIPTION

FIG. 1 is a bottom plan view of an access point showing my new design;
FIG. 2 is a right side elevational view thereof;
FIG. 3 is a front elevational view thereof;
FIG. 4 is a left side elevational view thereof;
FIG. 5 is a top plan view thereof;
FIG. 6 is a perspective view thereof as viewed from the front;
FIG. 7 is a rear elevational view thereof;
FIG. 8 is a perspective view thereof as viewed from the rear;
FIG. 9 is a perspective view thereof as viewed from the front, as shown in the open position; and,
FIG. 10 is a left side elevational view thereof, in the open position.

1 Claim, 5 Drawing Sheets

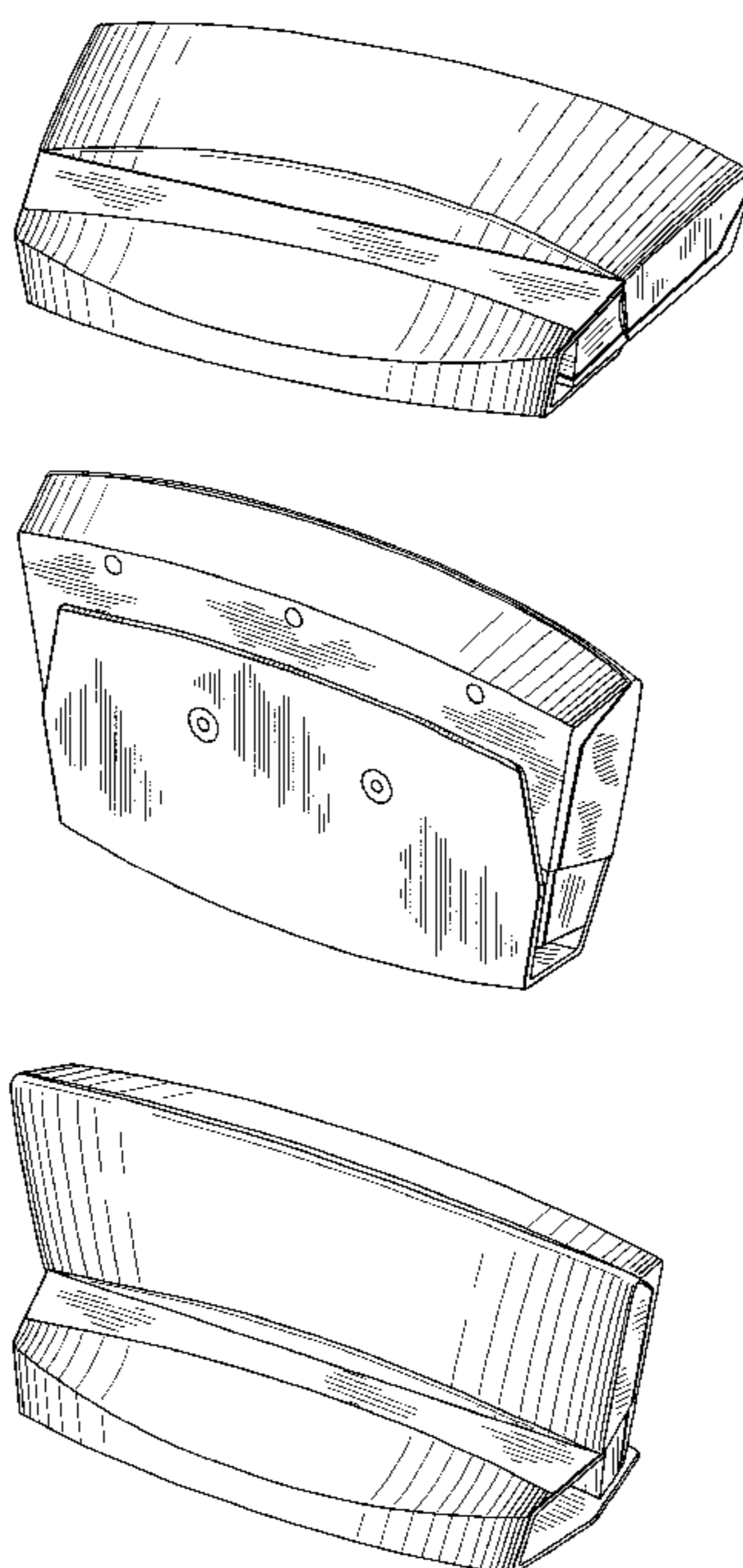

FIG. 1

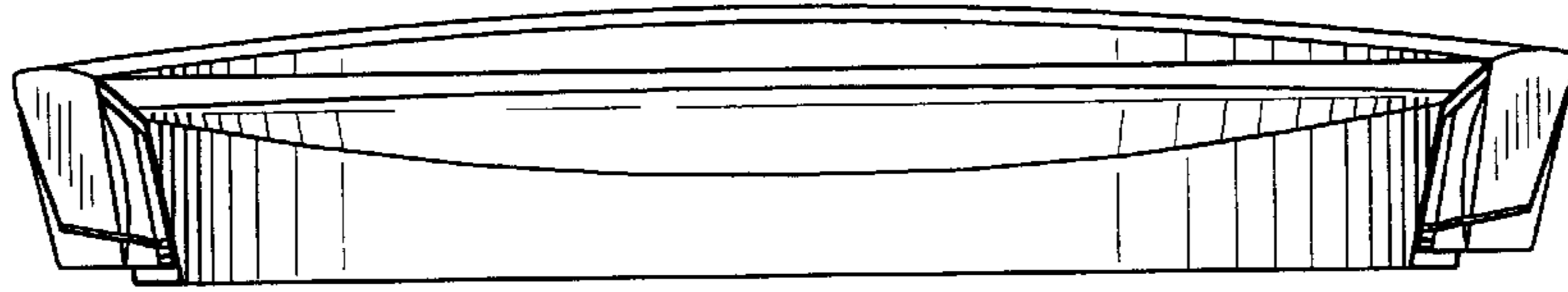

FIG. 2

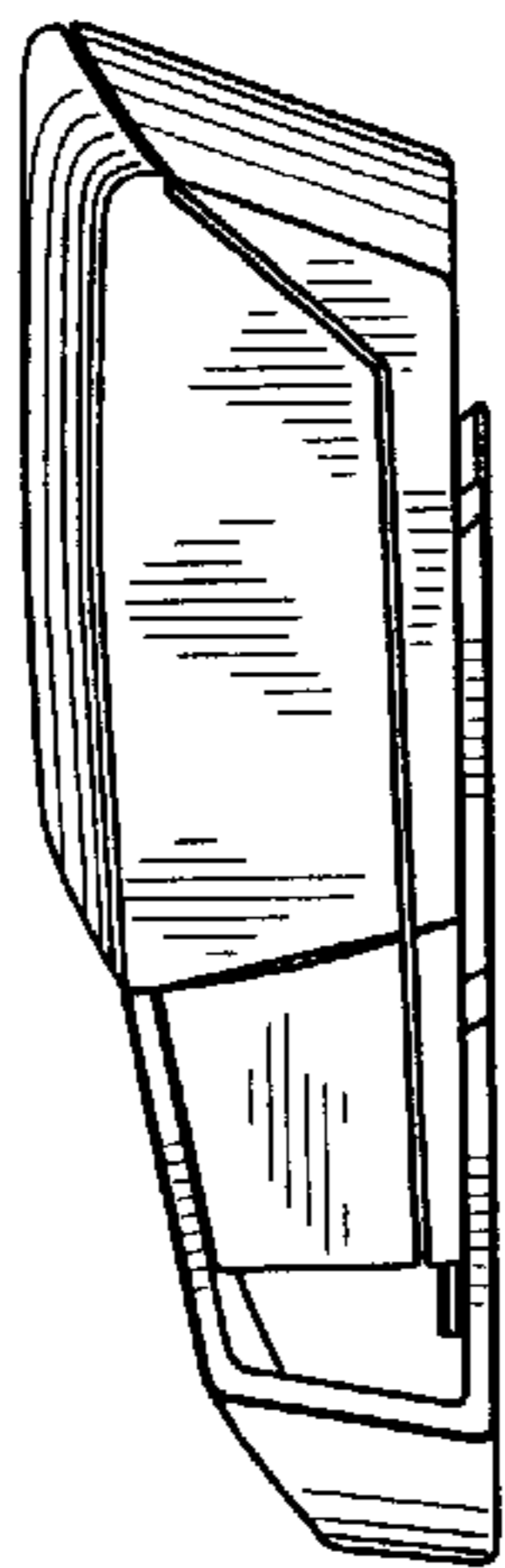

FIG. 4

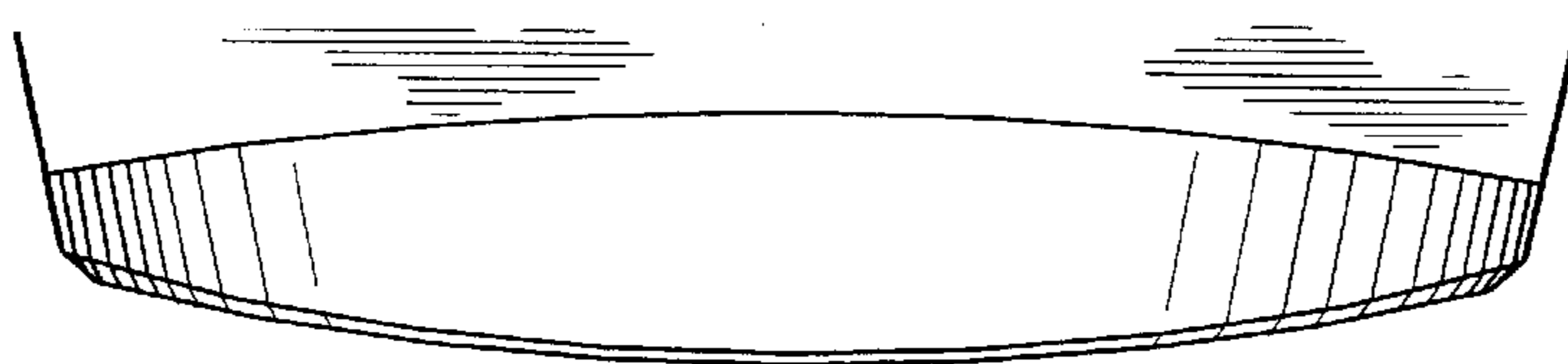
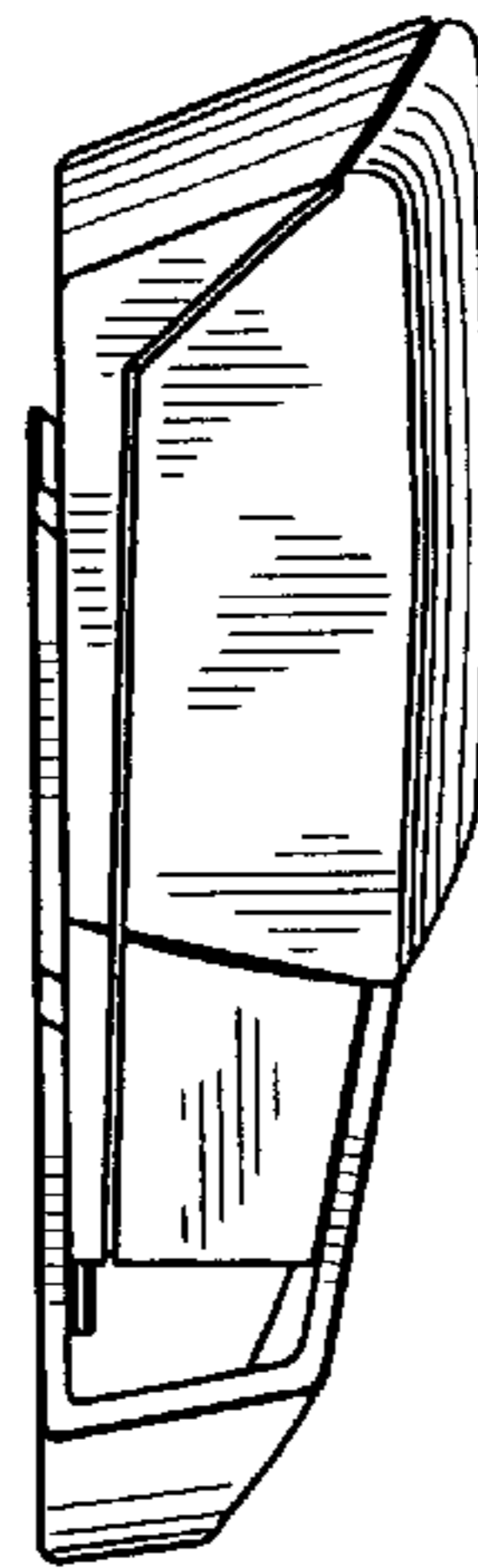

FIG. 3

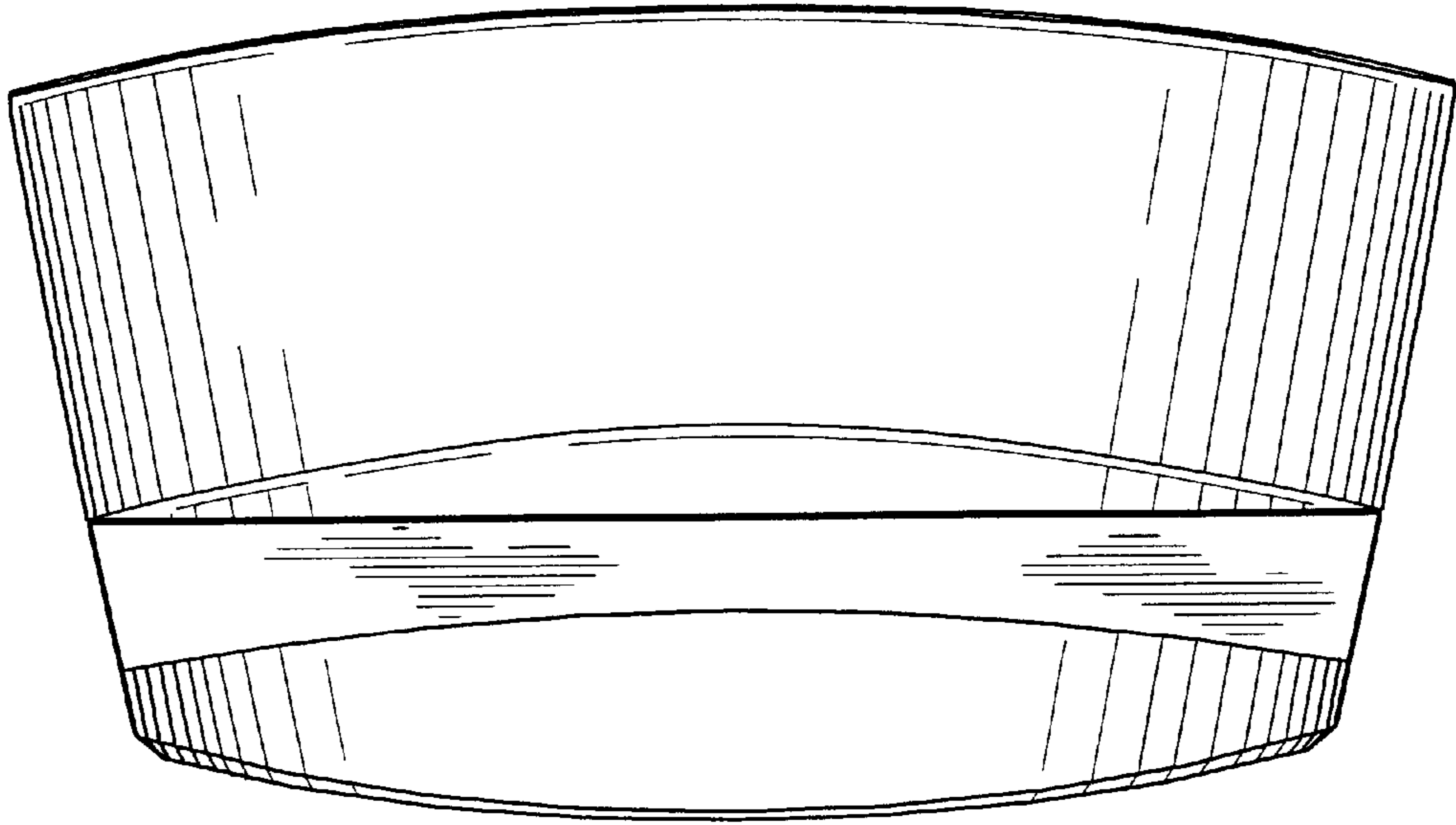

FIG. 6

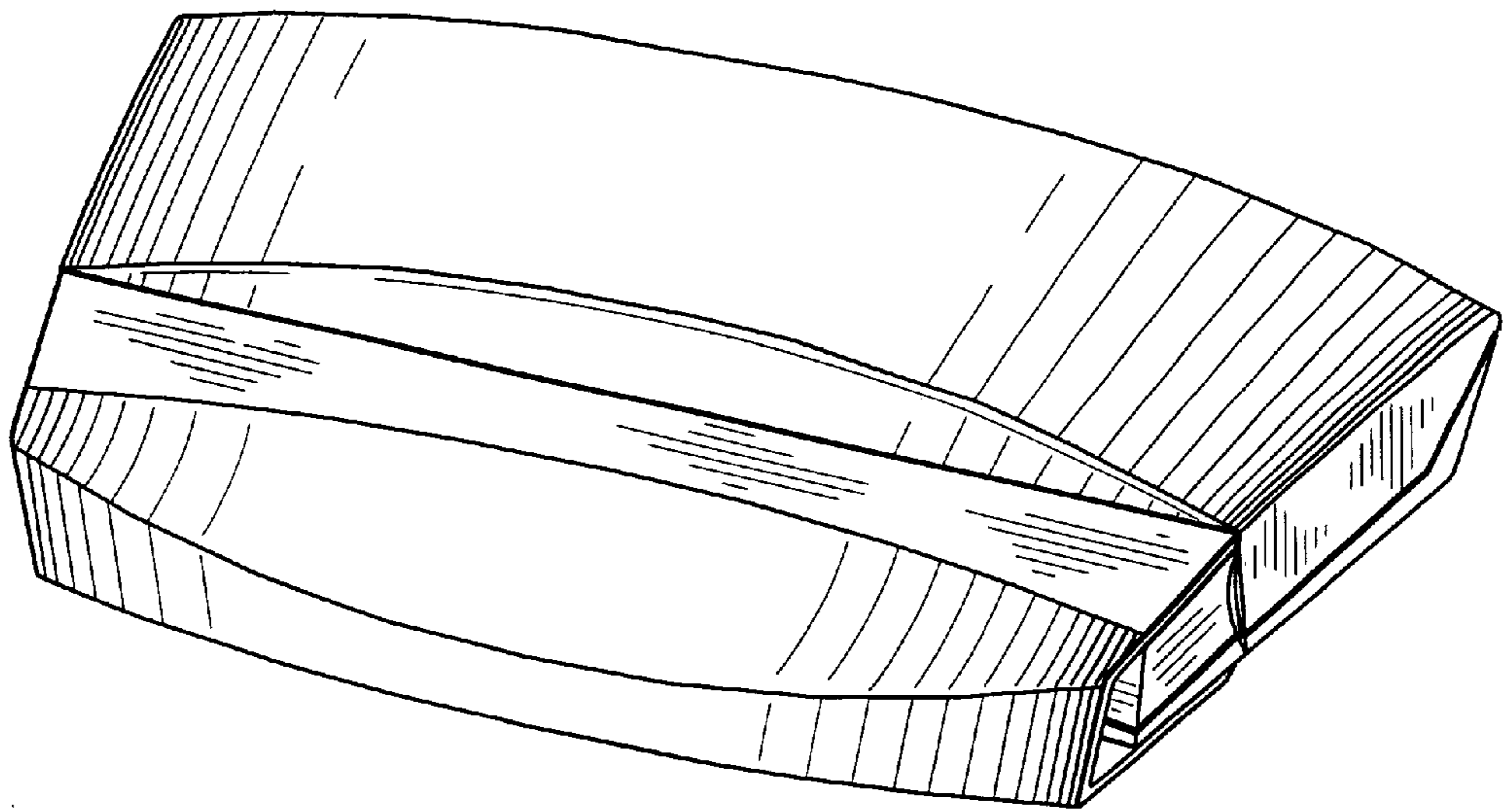

FIG. 5

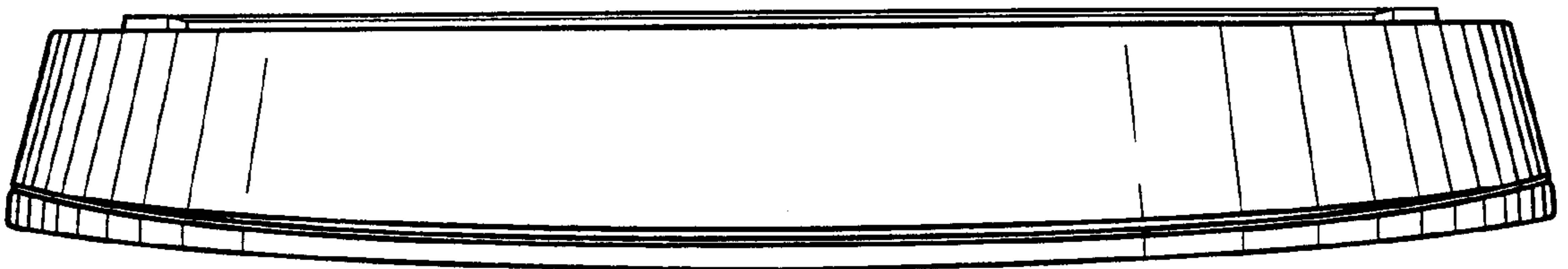

FIG. 7

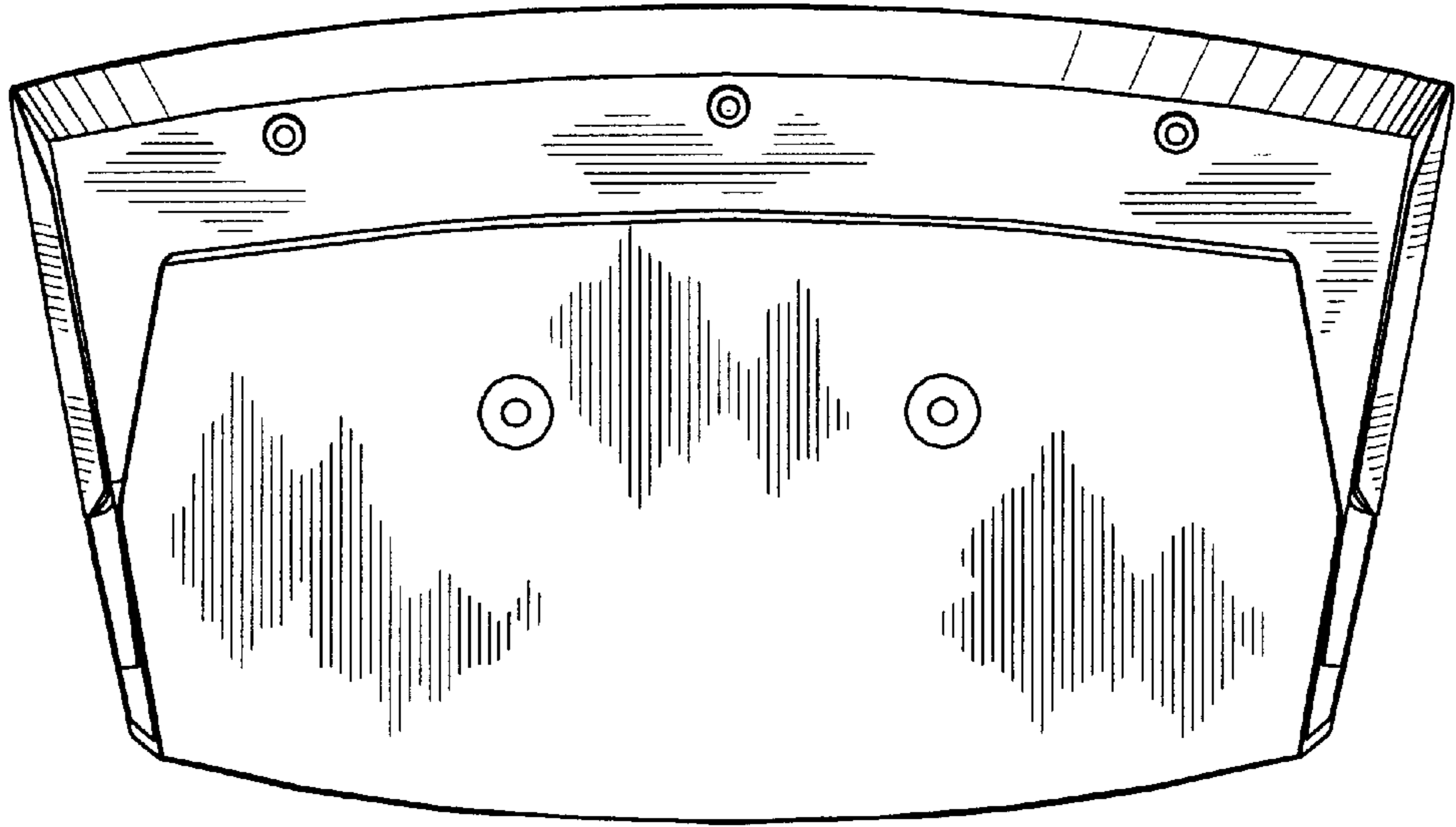

FIG. 8

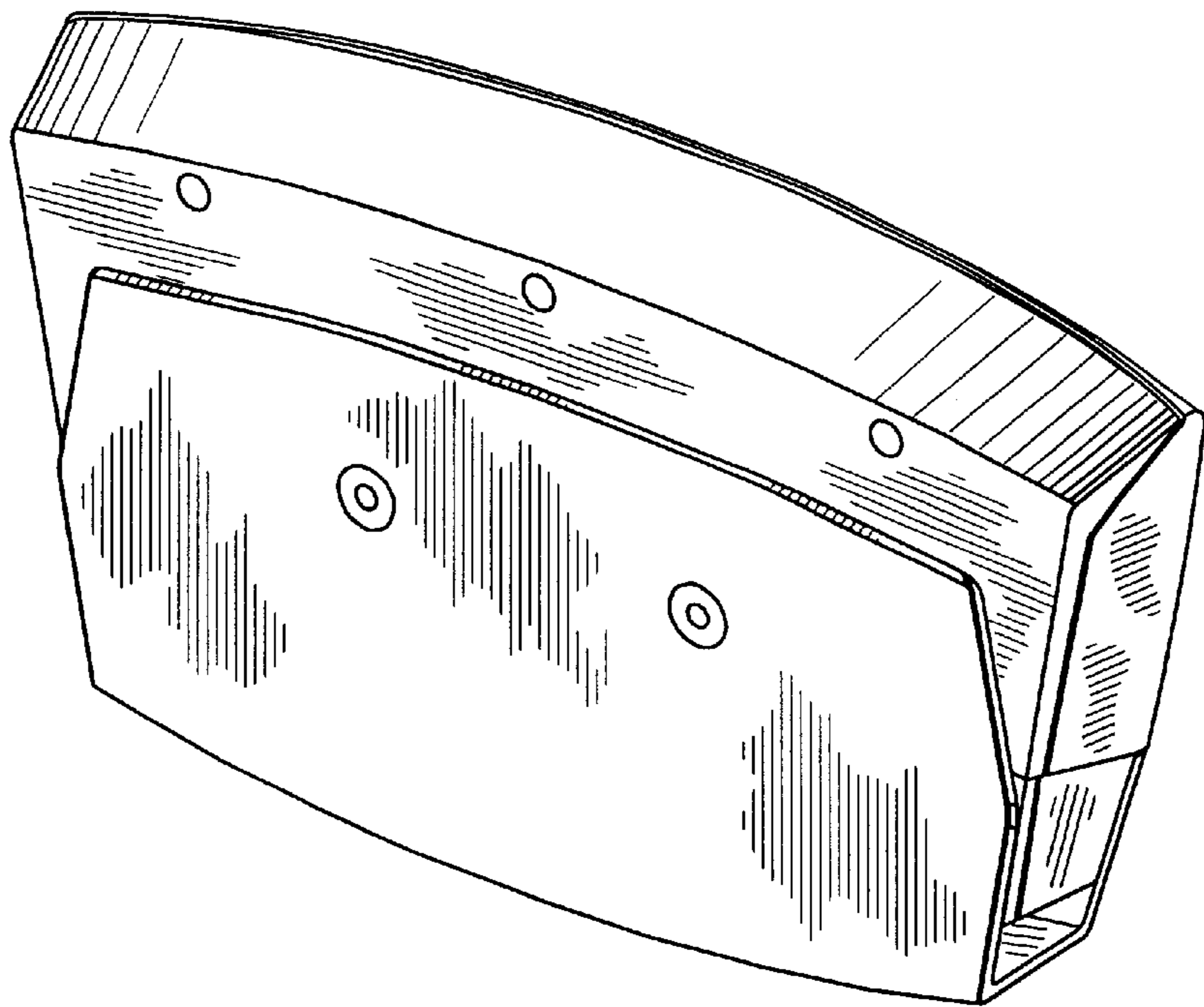

FIG. 9

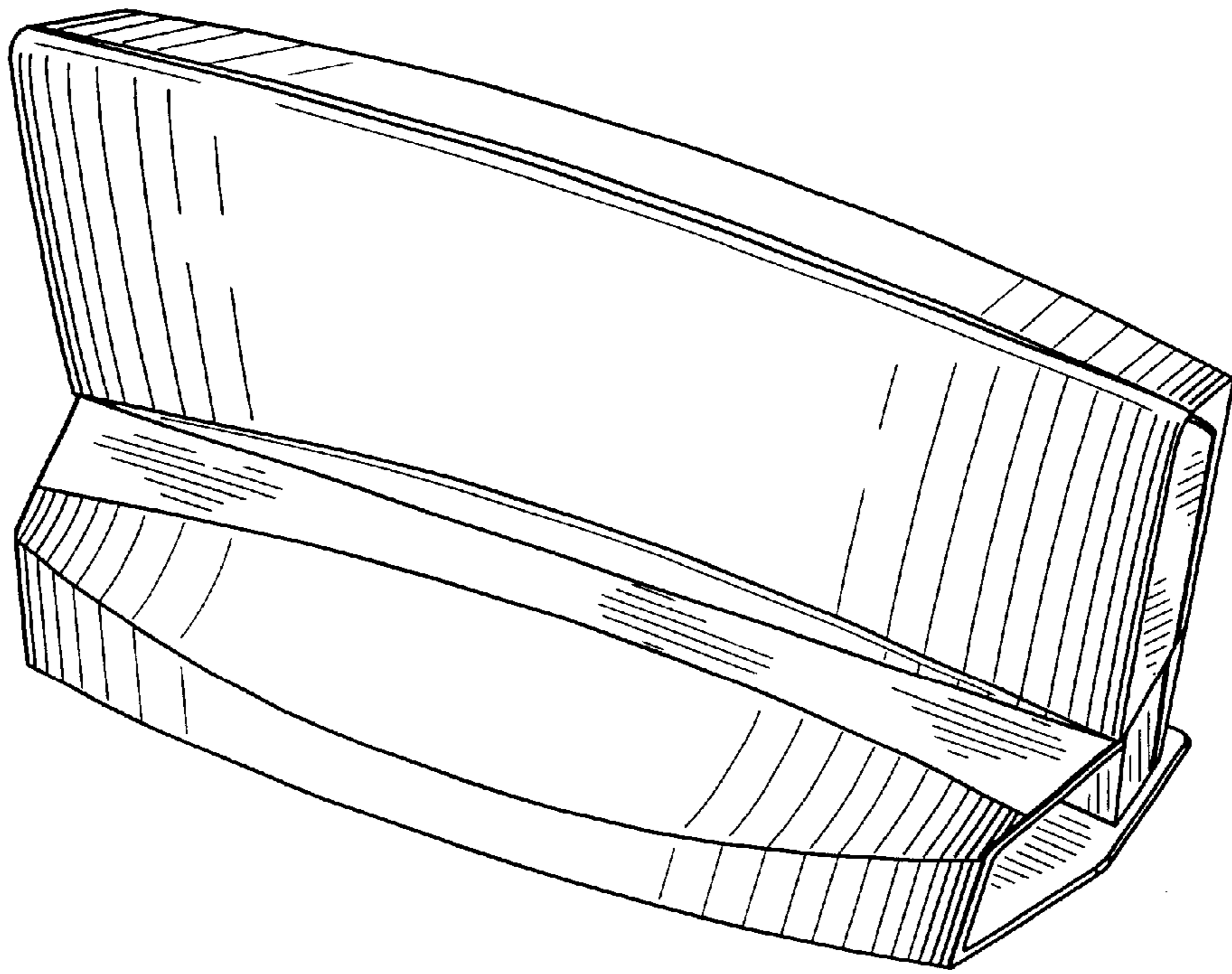

FIG. 10

