



US00D480658S

(12) **United States Design Patent**
Manning

(10) **Patent No.:** **US D480,658 S**

(45) **Date of Patent:** **** Oct. 14, 2003**

(54) **JEWELRY WITH GEMSTONE**

(75) Inventor: **Tom Manning**, Powell, OH (US)

(73) Assignee: **Jovian Designs, Inc.**, Las Vegas, NV (US)

(*) Notice: This patent is subject to a terminal disclaimer.

(**) Term: **14 Years**

(21) Appl. No.: **29/164,830**

(22) Filed: **Jul. 31, 2002**

(51) **LOC (7) Cl.** **11-02**

(52) **U.S. Cl.** **D11/83; D11/82**

(58) **Field of Search** D11/1, 2, 7, 43-45, D11/47-49, 53, 56-57, 61, 65-66, 70, 79-83, 96-97, 99-100, 103, 108-109, 111, 160; 63/18-20, 23

(56) **References Cited**

U.S. PATENT DOCUMENTS

- D205,900 S * 10/1966 Fenner et al. D11/53
- D250,885 S * 1/1979 Newman D11/160
- D383,703 S * 9/1997 Koumi D11/83

- D392,207 S * 3/1998 Koumi D11/83
- D395,843 S * 7/1998 D'Ambrosio D11/83
- D401,528 S * 11/1998 Genovese D11/48

* cited by examiner

Primary Examiner—Ralf Seifert

(74) *Attorney, Agent, or Firm*—Porter, Wright, Morris & Arthur, LLP

(57) **CLAIM**

The ornamental design for jewelry with gemstone, as shown and described.

DESCRIPTION

FIG. 1 is an elevational view of my jewelry with gemstone. FIG. 2 is a front elevational view of my jewelry with gemstone.

FIG. 3 is a rear elevational view of my jewelry with gemstone.

FIG. 4 is a left side elevational view of my jewelry with gemstone. The right side is a mirror image of the left side.

FIG. 5 is a top plan view of my jewelry with gemstone; and, FIG. 6 is a bottom plan view of my jewelry with gemstone.

The phantom lines in the figure are for illustrative purposes only and form no part of the claimed design.

1 Claim, 5 Drawing Sheets

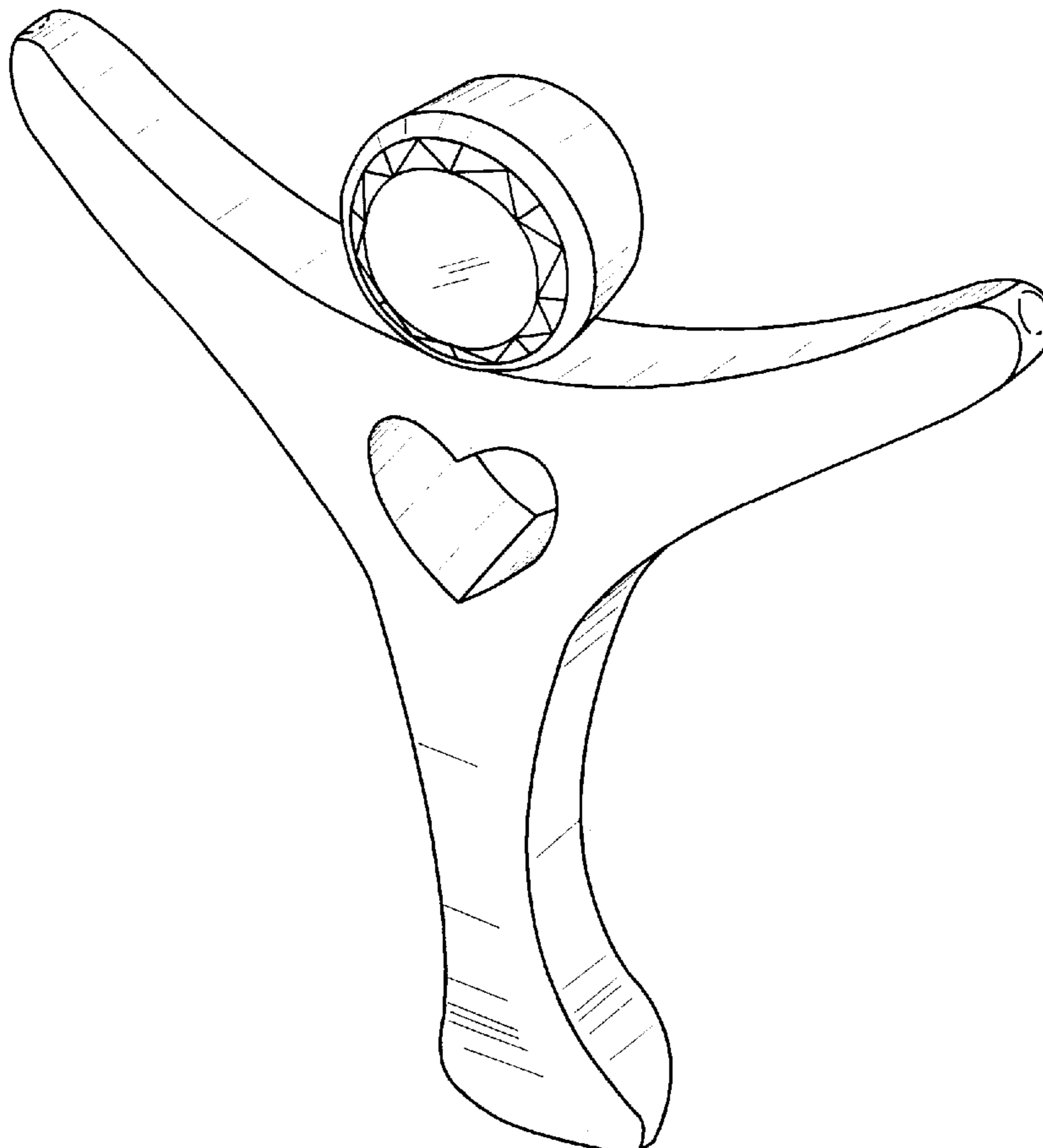

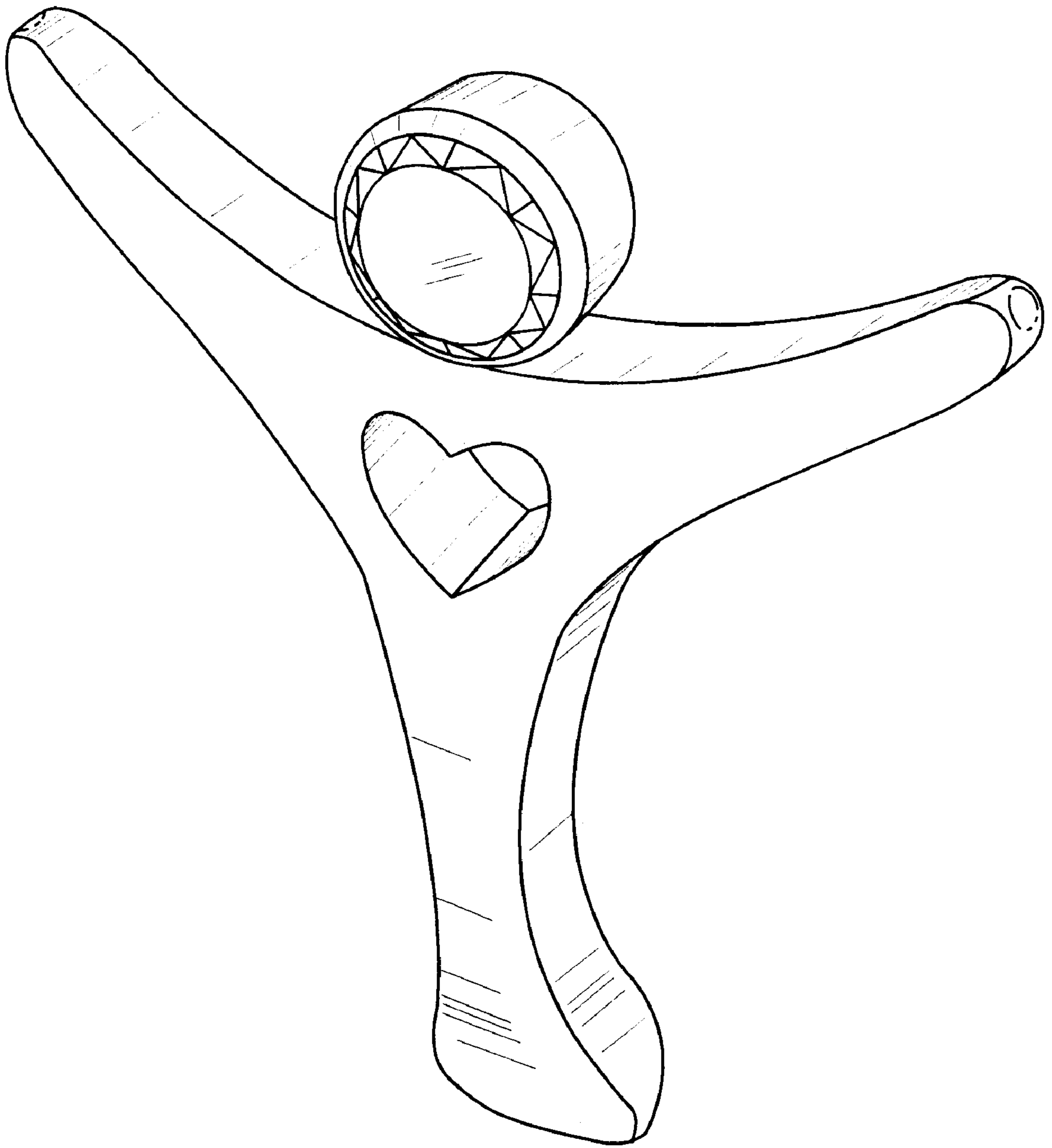

Fig. 1

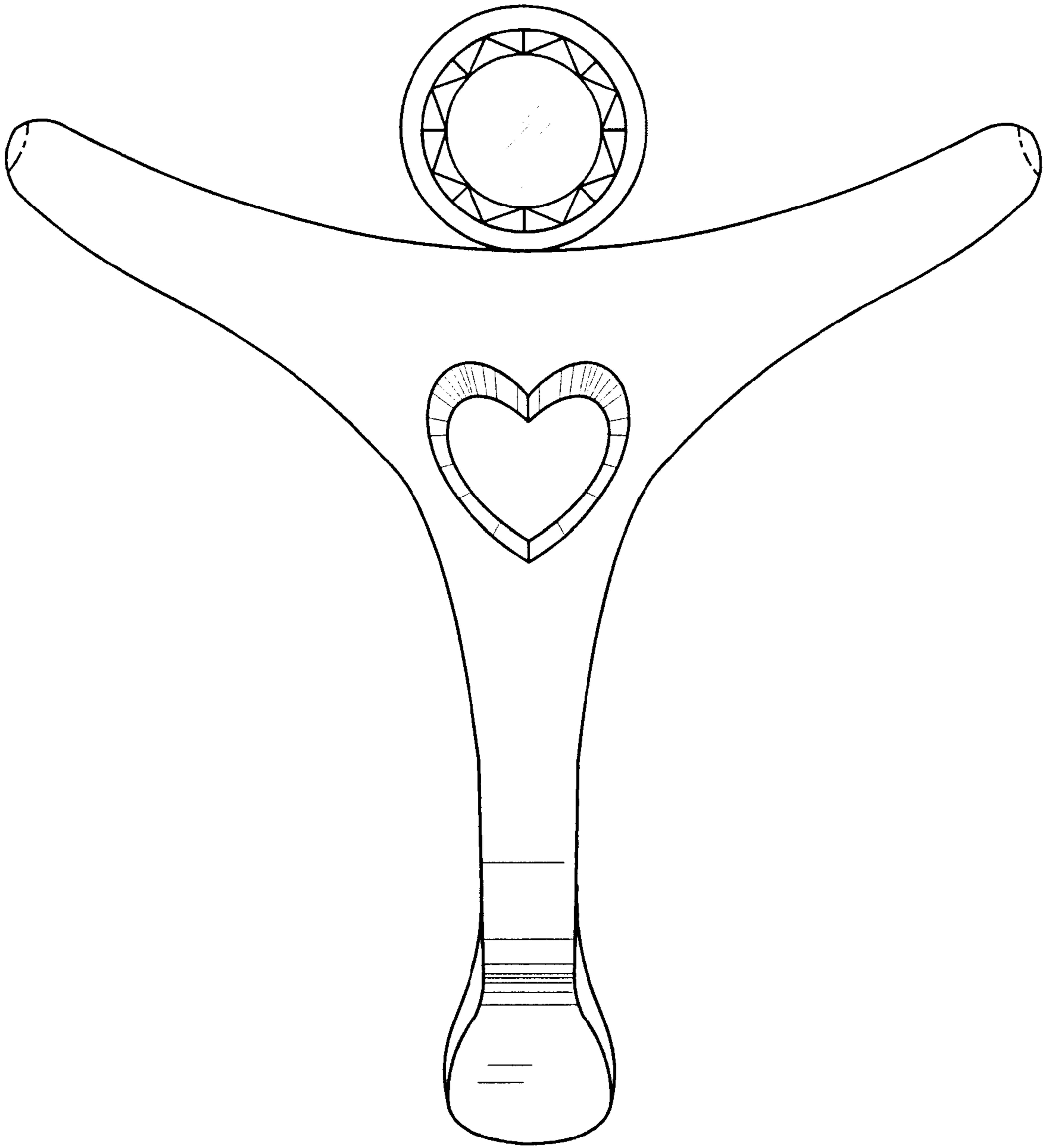

Fig. 2

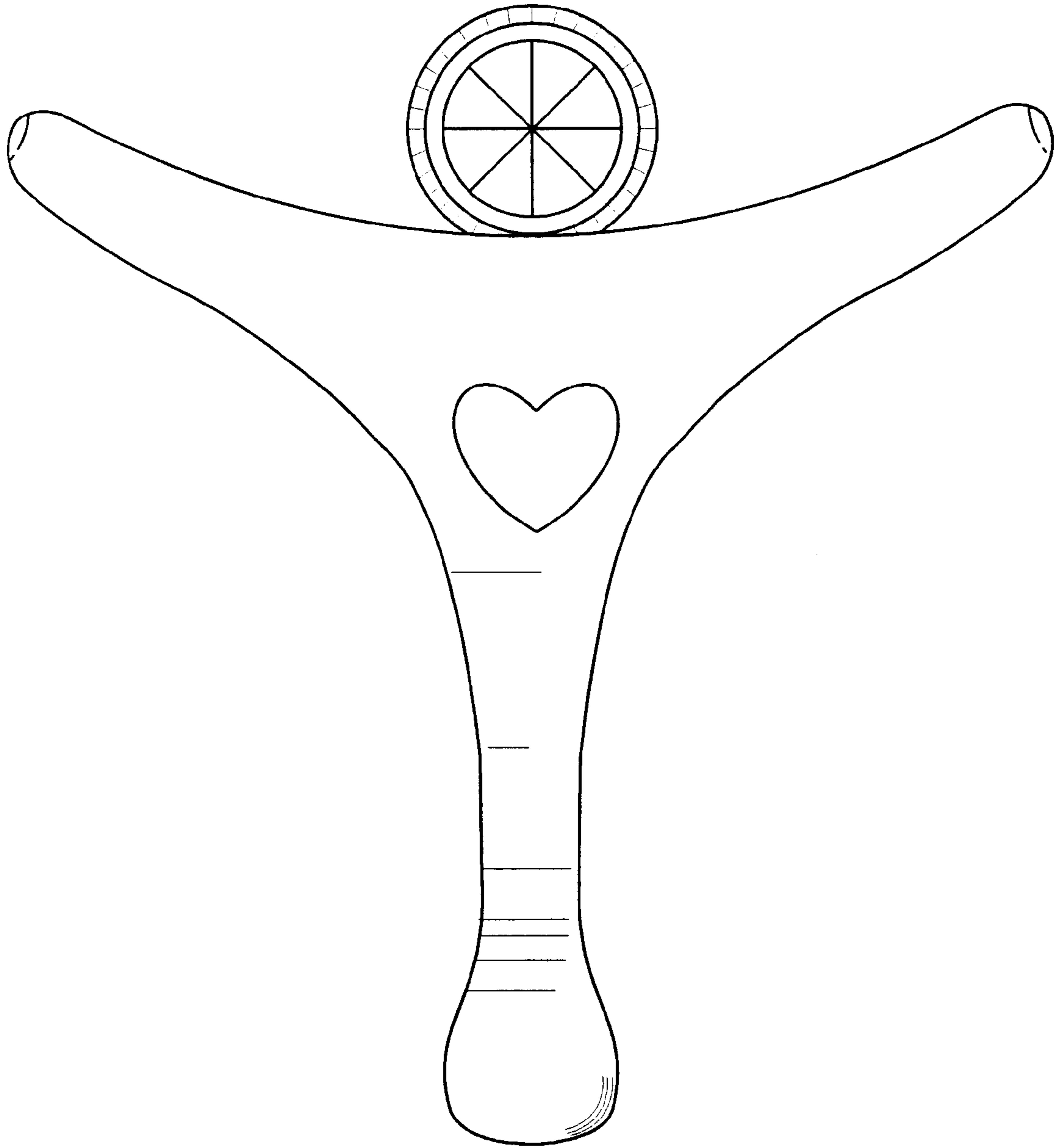

Fig. 3

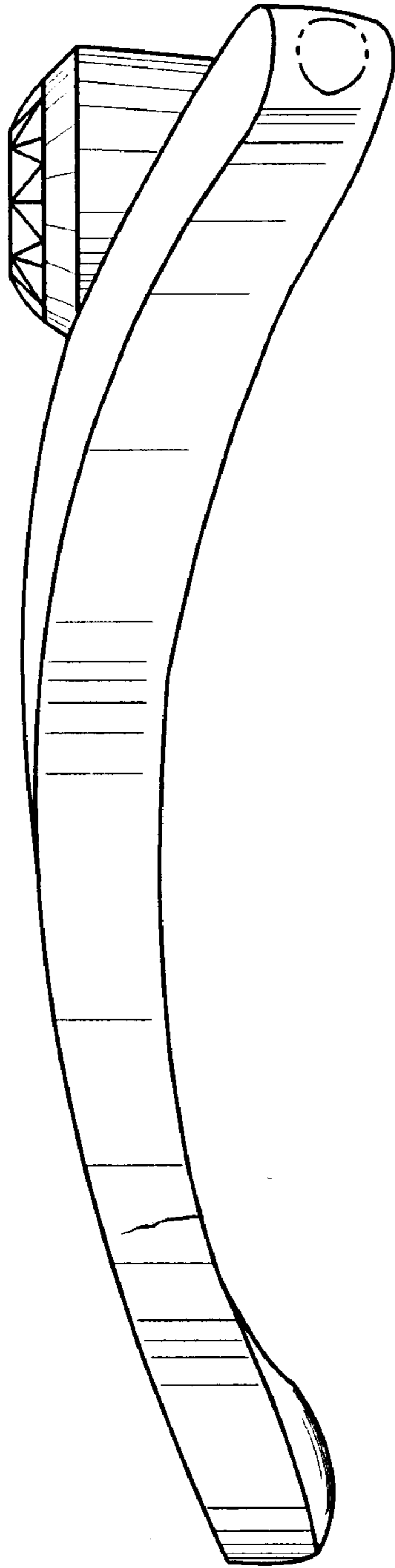

Fig. 4

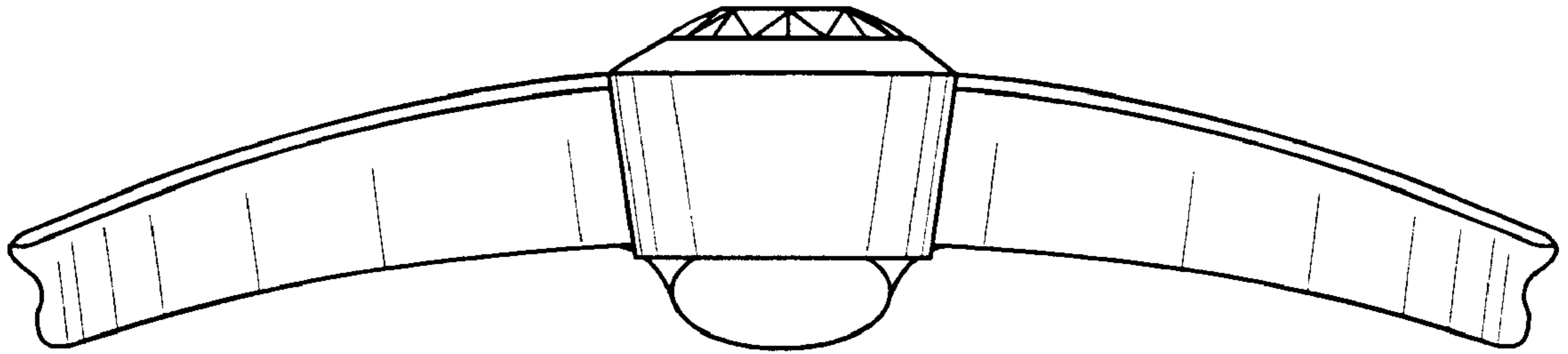

Fig. 5

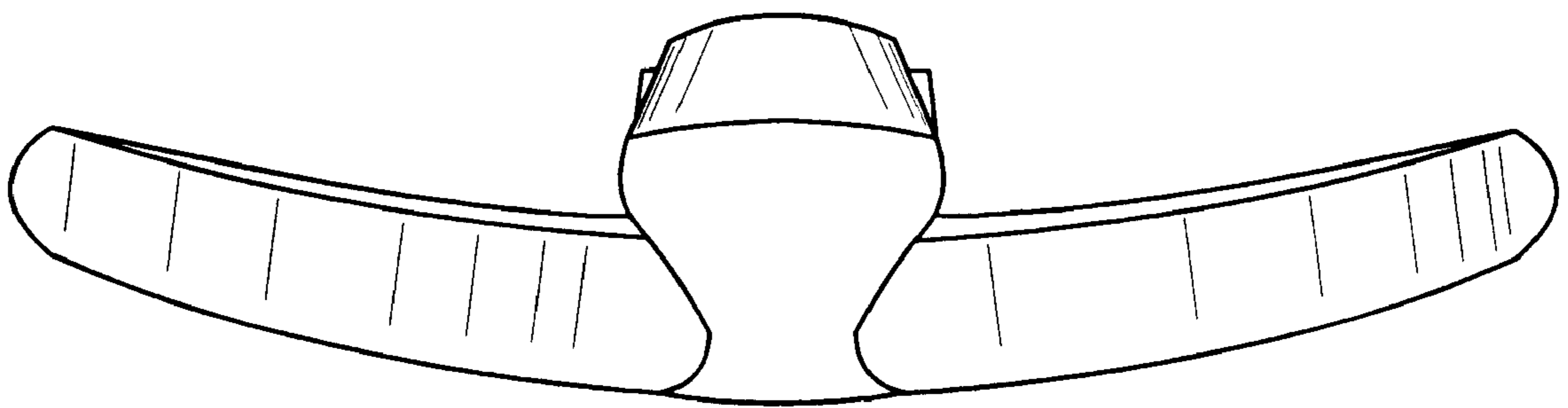

Fig. 6