



US00D480558S

(12) **United States Design Patent**
Ikeda et al.

(10) **Patent No.:** **US D480,558 S**

(45) **Date of Patent:** **** Oct. 14, 2003**

(54) **INSTRUMENT HOLSTER**

D410,332 S * 6/1999 Luchka D3/228
D462,514 S * 9/2002 Rivera et al. D3/228

(75) Inventors: **John K. Ikeda**, Seattle, WA (US);
Chris W. Lagerberg, Seattle, WA (US)

* cited by examiner

(73) Assignee: **Fluke Corporation**, Everett, WA (US)

Primary Examiner—Catherine R. Oliver
(74) *Attorney, Agent, or Firm*—Richard A. Koske

(**) Term: **14 Years**

(57) **CLAIM**

(21) Appl. No.: **29/170,057**

The ornamental design for an instrument holster, as shown.

(22) Filed: **Oct. 30, 2002**

DESCRIPTION

(51) **LOC (7) Cl.** **03-01**

(52) **U.S. Cl.** **D3/228**

(58) **Field of Search** D3/228, 218, 201,
D3/215, 226, 223, 224; D10/78, 75, 76,
46, 80; 224/267, 912

FIG. 1 is a perspective view of an instrument holster showing our new design;
FIG. 2 is a front elevation view thereof;
FIG. 3 is a right side elevation view thereof;
FIG. 4 is a left side elevation view thereof;
FIG. 5 is a rear elevation view thereof;
FIG. 6 is a top plan view thereof;
FIG. 7 is a bottom plan view thereof; and,
FIG. 8 is a perspective view thereof shown with broken lines removed.

(56) **References Cited**

U.S. PATENT DOCUMENTS

D312,534 S	12/1990	Nelson et al.	D3/228
D325,471 S	4/1992	McCain et al.	D3/228
D337,435 S	7/1993	Kaneko et al.	D3/228
D361,657 S	8/1995	Ledbetter et al.	D3/228
D365,927 S	* 1/1996	Cho	D3/218
D397,246 S	8/1998	Hoofnagle et al.	D3/201

The broken lines shown in the figures are for illustrative purposes only and form no part of the claimed design.

1 Claim, 5 Drawing Sheets

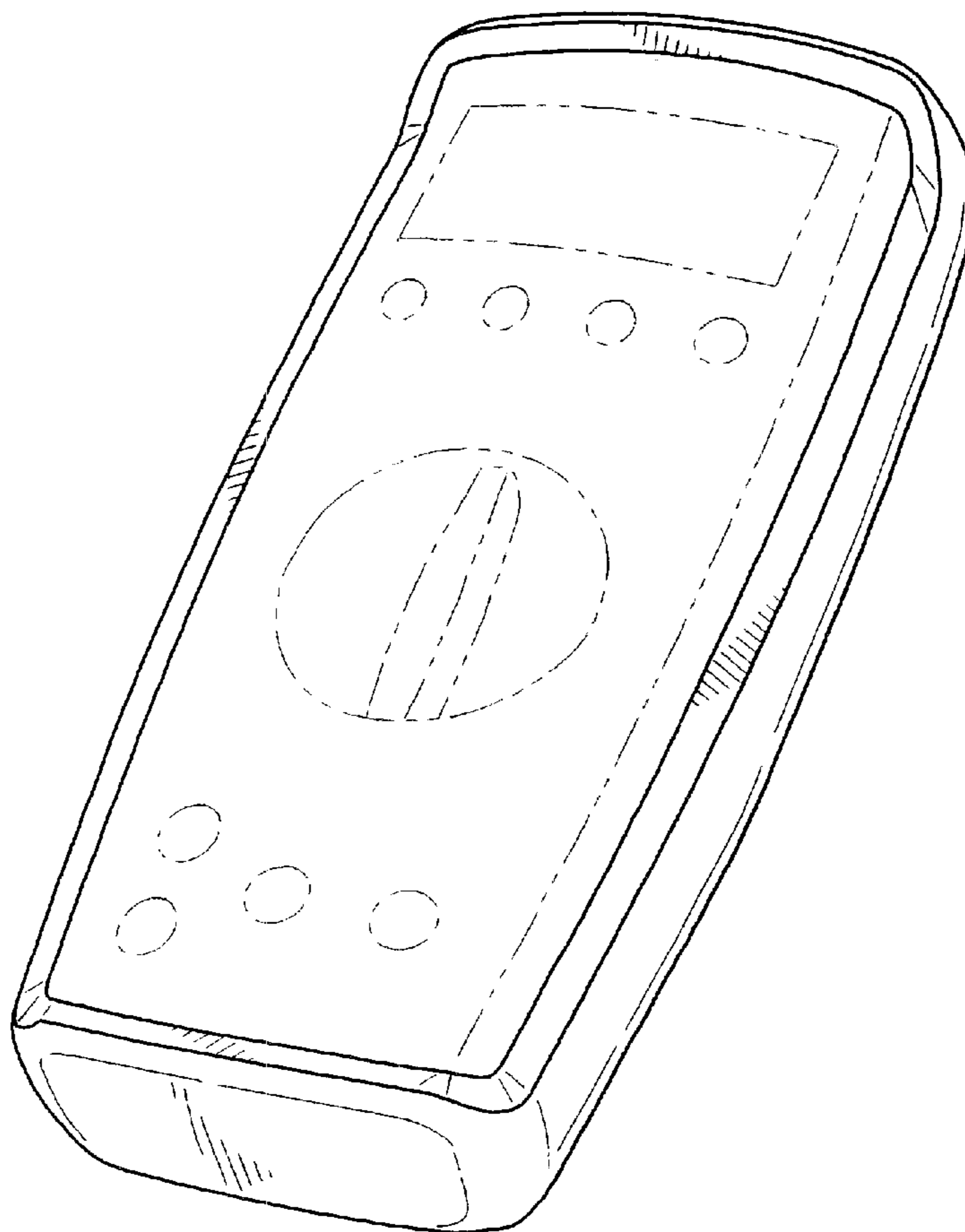

FIG. 1

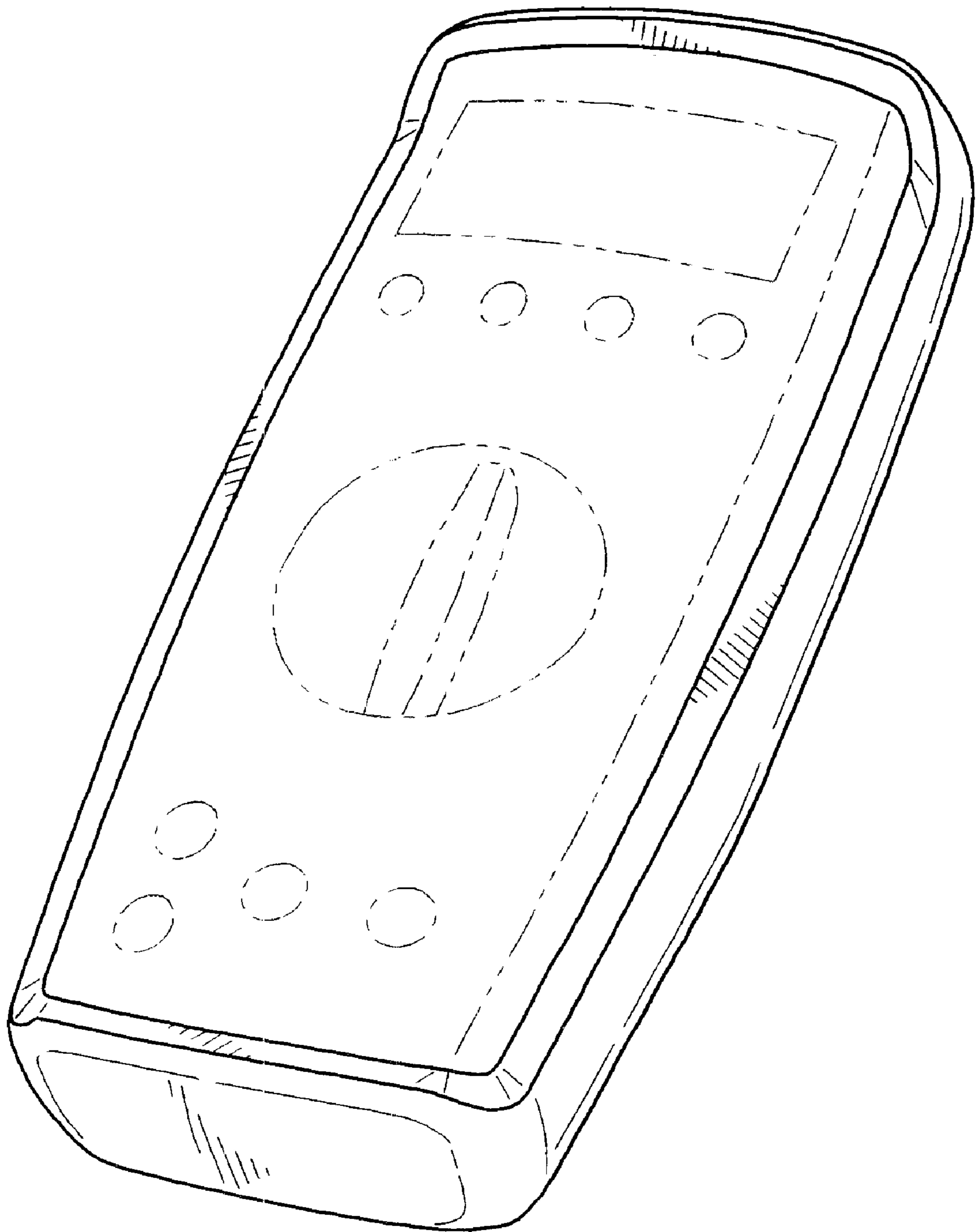

FIG. 2

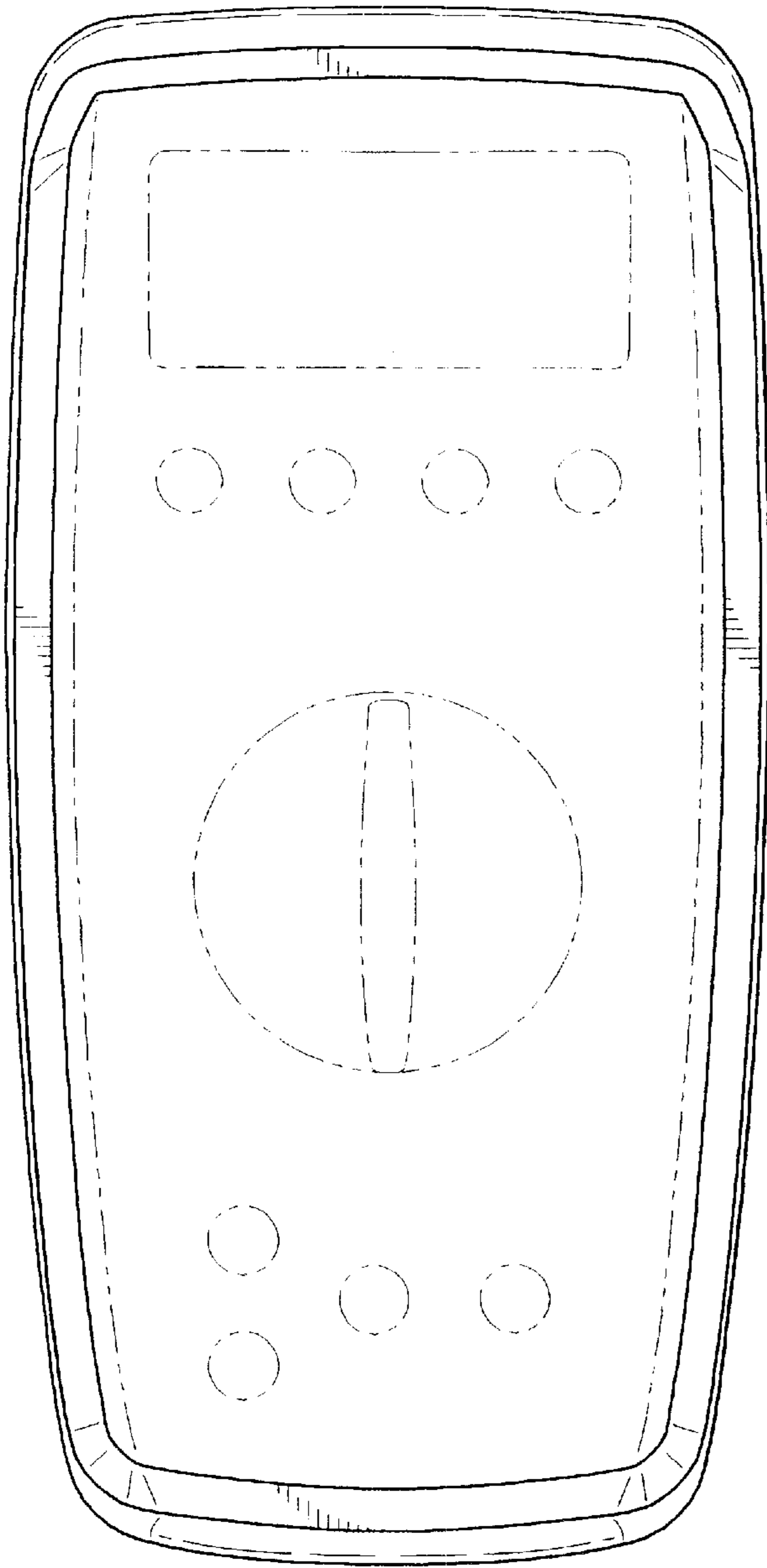

FIG. 3

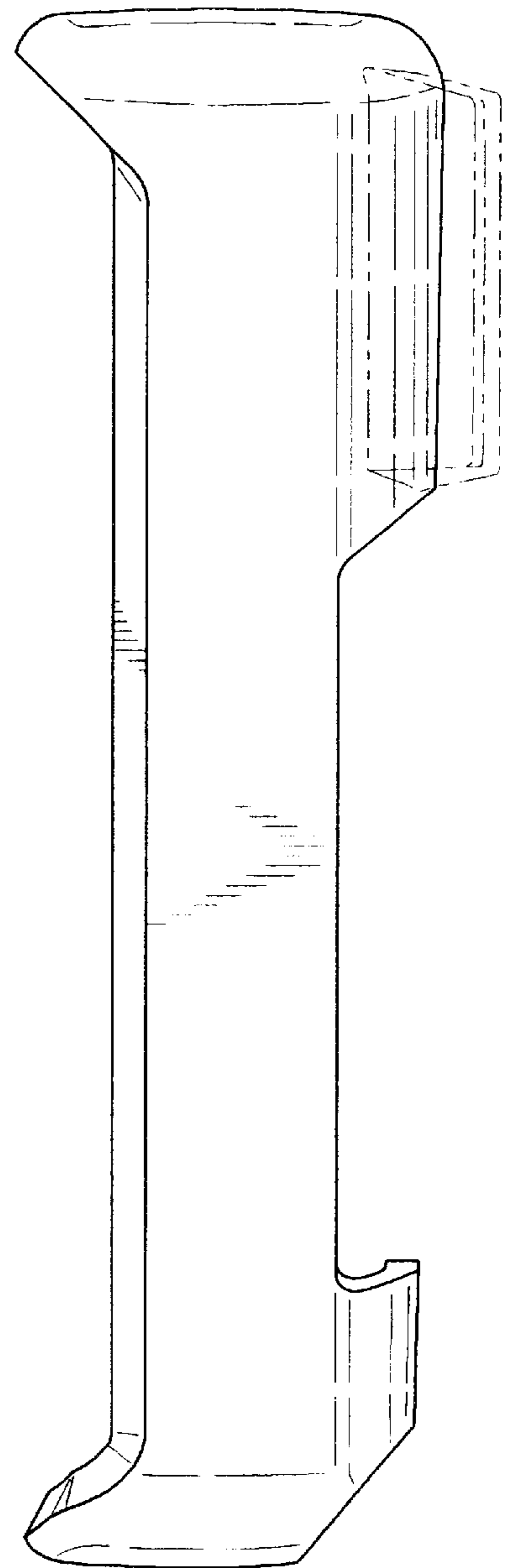

FIG. 4

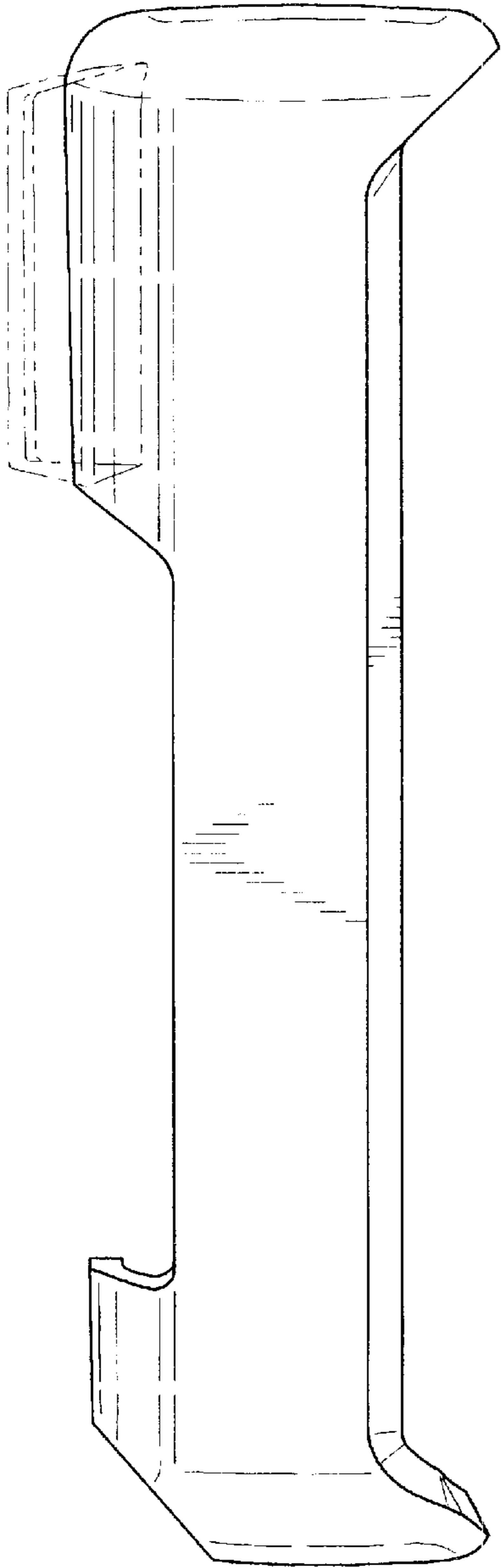

FIG. 5

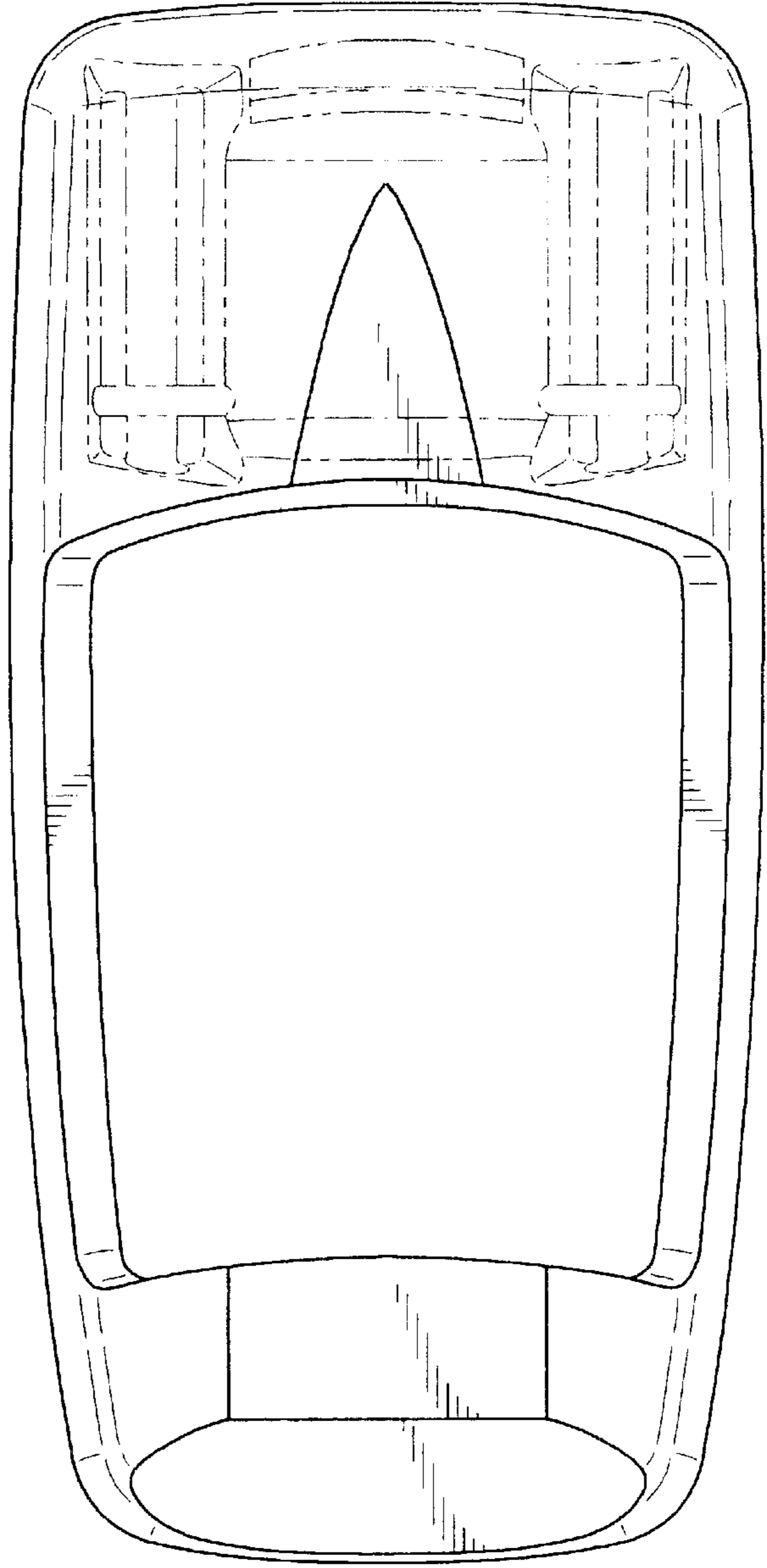

FIG. 6

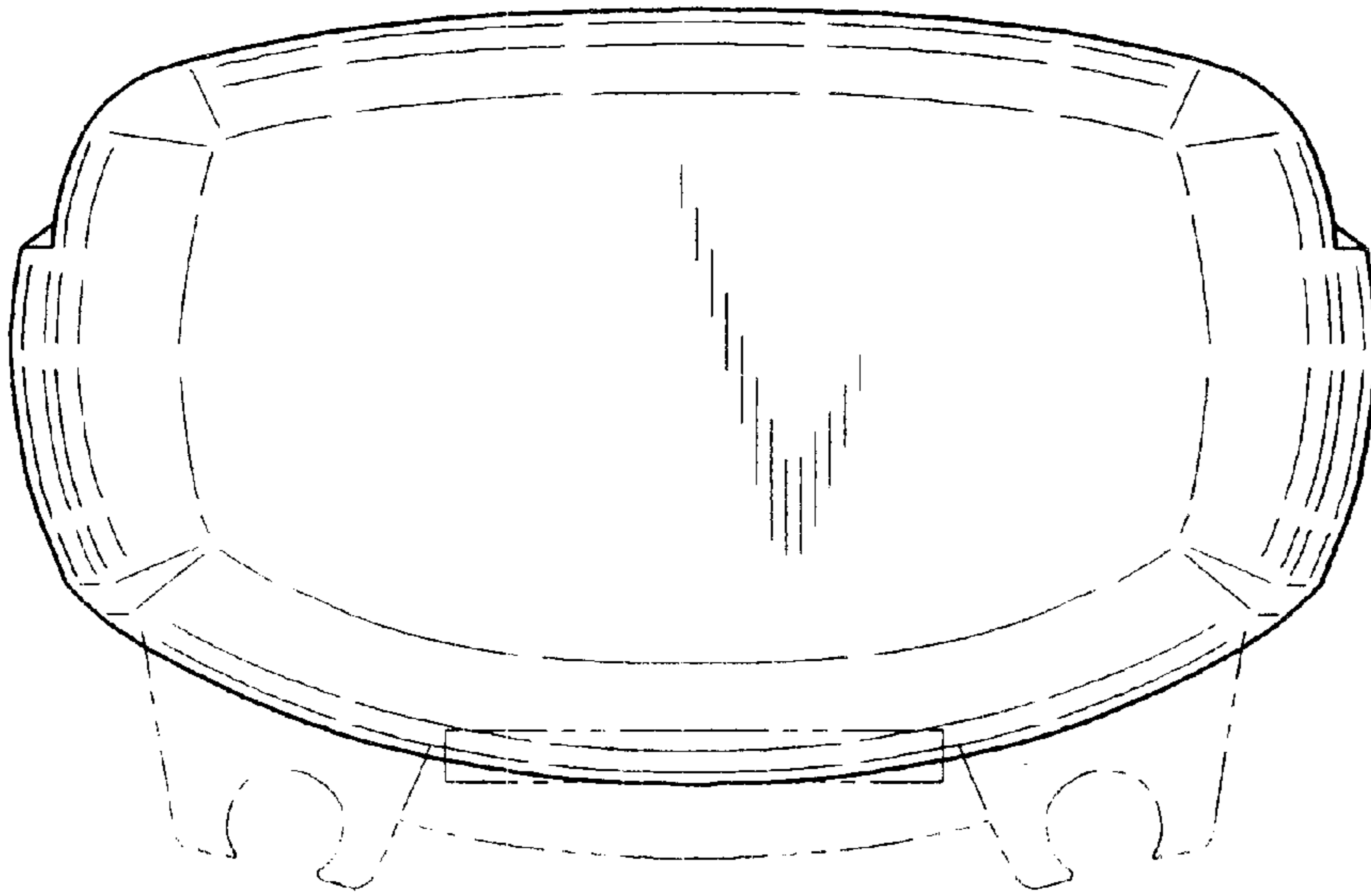

FIG. 7

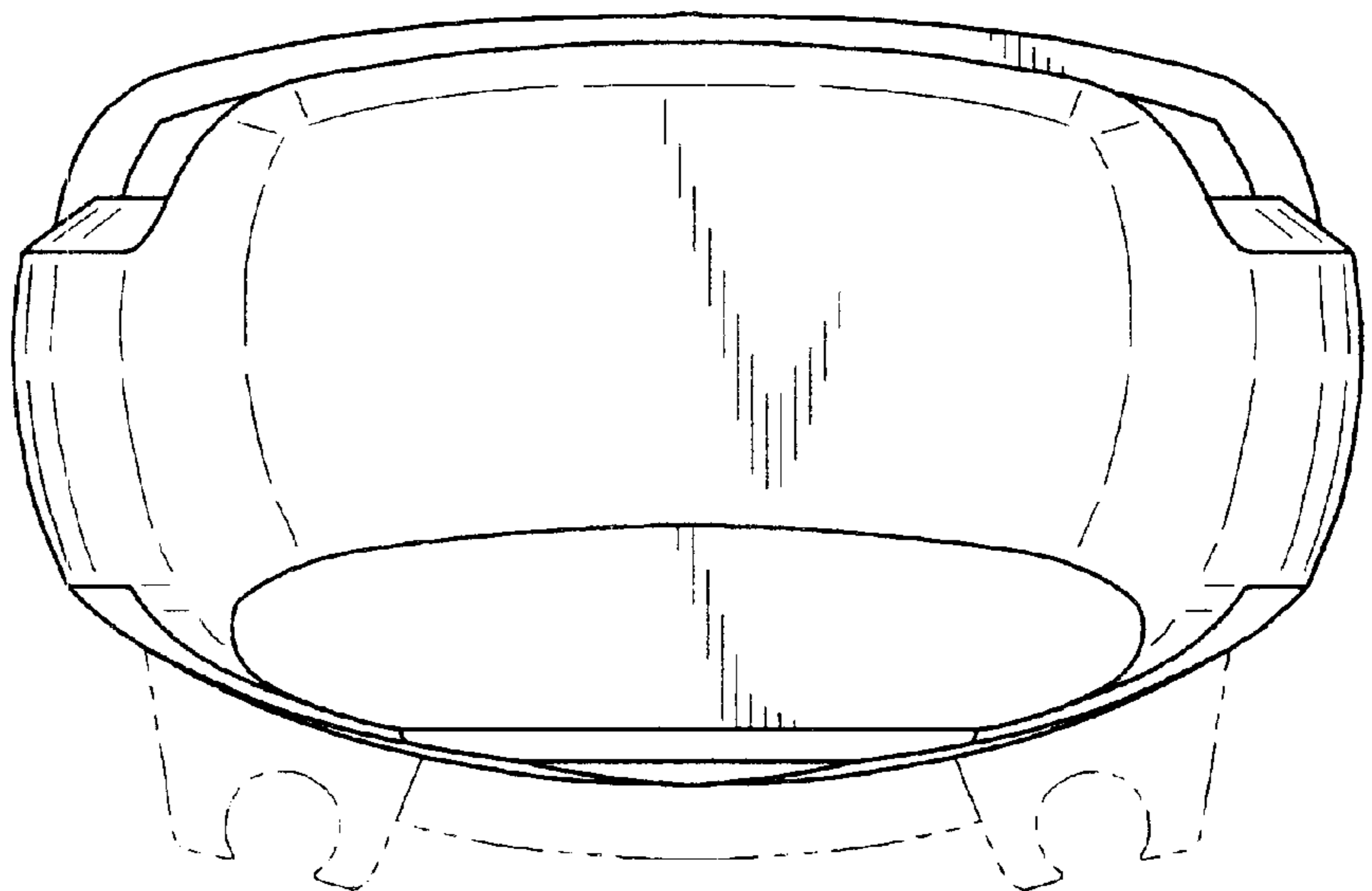

FIG. 8

