



US00D480491S

(12) **United States Design Patent**
Lai

(10) **Patent No.:** **US D480,491 S**

(45) **Date of Patent:** **** Oct. 7, 2003**

(54) **TORCH**

(76) Inventor: **Kevin Lai**, Flat N, 10F, Everest Industrial Center, 396 Kwun Tong Road, Kowloon, Hong Kong (CN)

(**) Term: **14 Years**

(21) Appl. No.: **29/171,271**

(22) Filed: **Nov. 19, 2002**

(51) **LOC (7) Cl.** **26-02**

(52) **U.S. Cl.** **D26/37**

(58) **Field of Search** D26/37-50; 362/157, 362/158, 171, 172, 173, 183-208

(56) **References Cited**

U.S. PATENT DOCUMENTS

5,475,368	A	*	12/1995	Collins	340/573
D374,492	S	*	10/1996	Coe	D26/37
5,893,631	A	*	4/1999	Padden	362/201
D439,352	S	*	3/2001	Lai	D26/37
D443,086	S	*	5/2001	van Klinken	D26/37
6,270,234	B1	*	8/2001	Au-Yeung	362/189
D470,959	S	*	2/2003	Lai	D26/37

* cited by examiner

Primary Examiner—Marcus A. Jackson

(74) *Attorney, Agent, or Firm*—Sherman D. Pernia

(57) **CLAIM**

The ornamental design for a torch, as shown and described.

DESCRIPTION

FIG. 1 is a front view of an electric torch of my new design with the front cover in a closed position;

FIG. 2 is a front view thereof with the front cover in an open position;

FIG. 3 is a back view thereof;

FIG. 4 is a back view thereof with the battery cover removed;

FIG. 5 is a bottom view thereof with the battery cover removed;

FIG. 6 is a top view thereof;

FIG. 7 is a left side view thereof with the front cover in an open position and the battery cover removed;

FIG. 8 is a right side view thereof with the front cover in an open position and the battery cover removed;

FIG. 9 is a perspective view of the front, left side thereof with the cover in an open position and the battery cover removed;

FIG. 10 is a perspective view of the back, right side with the cover in an open position and the battery cover removed; and,

FIG. 11 is a back view of the battery cover thereof.

1 Claim, 6 Drawing Sheets

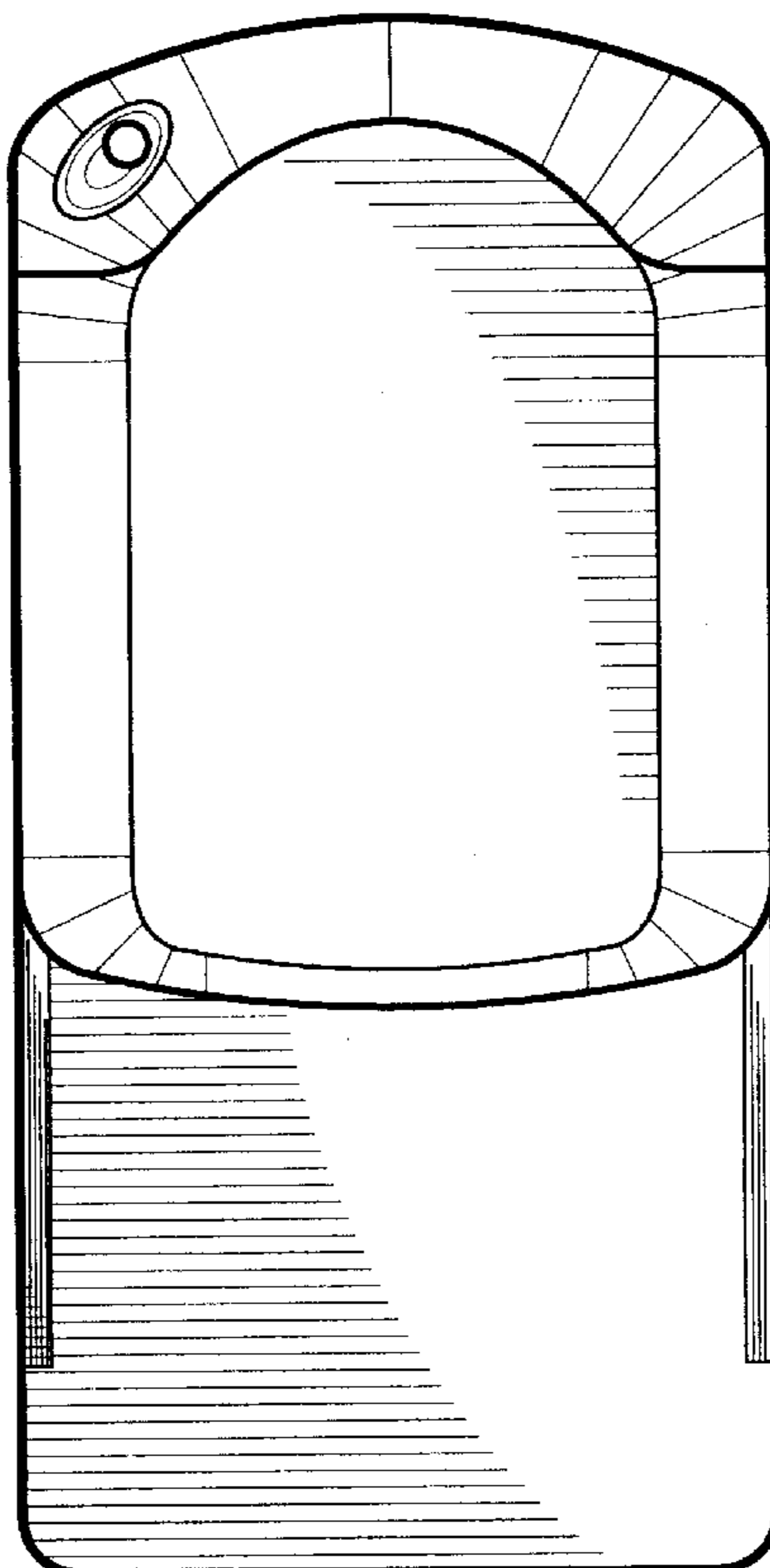

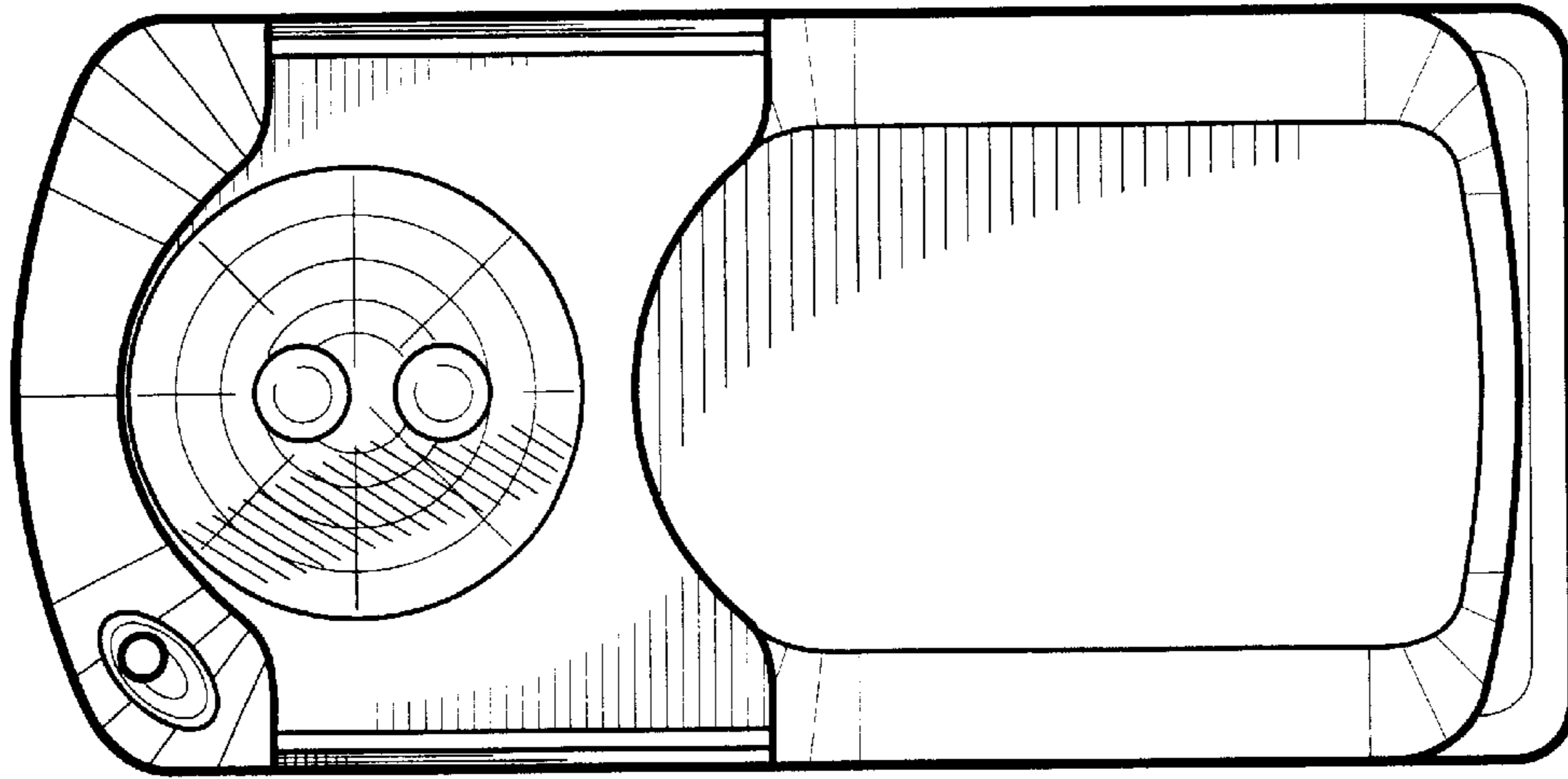

Fig. 2

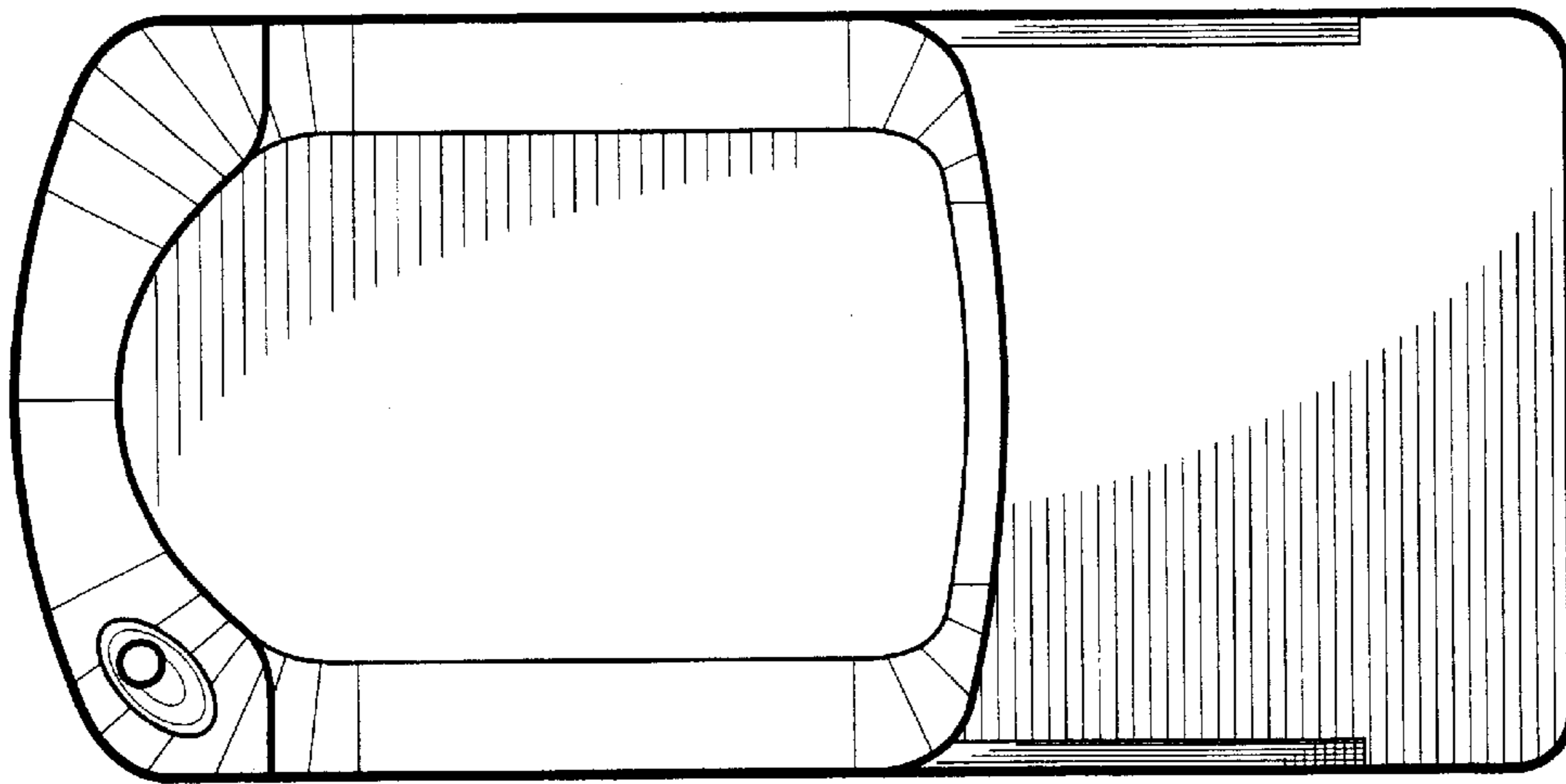

Fig. 1

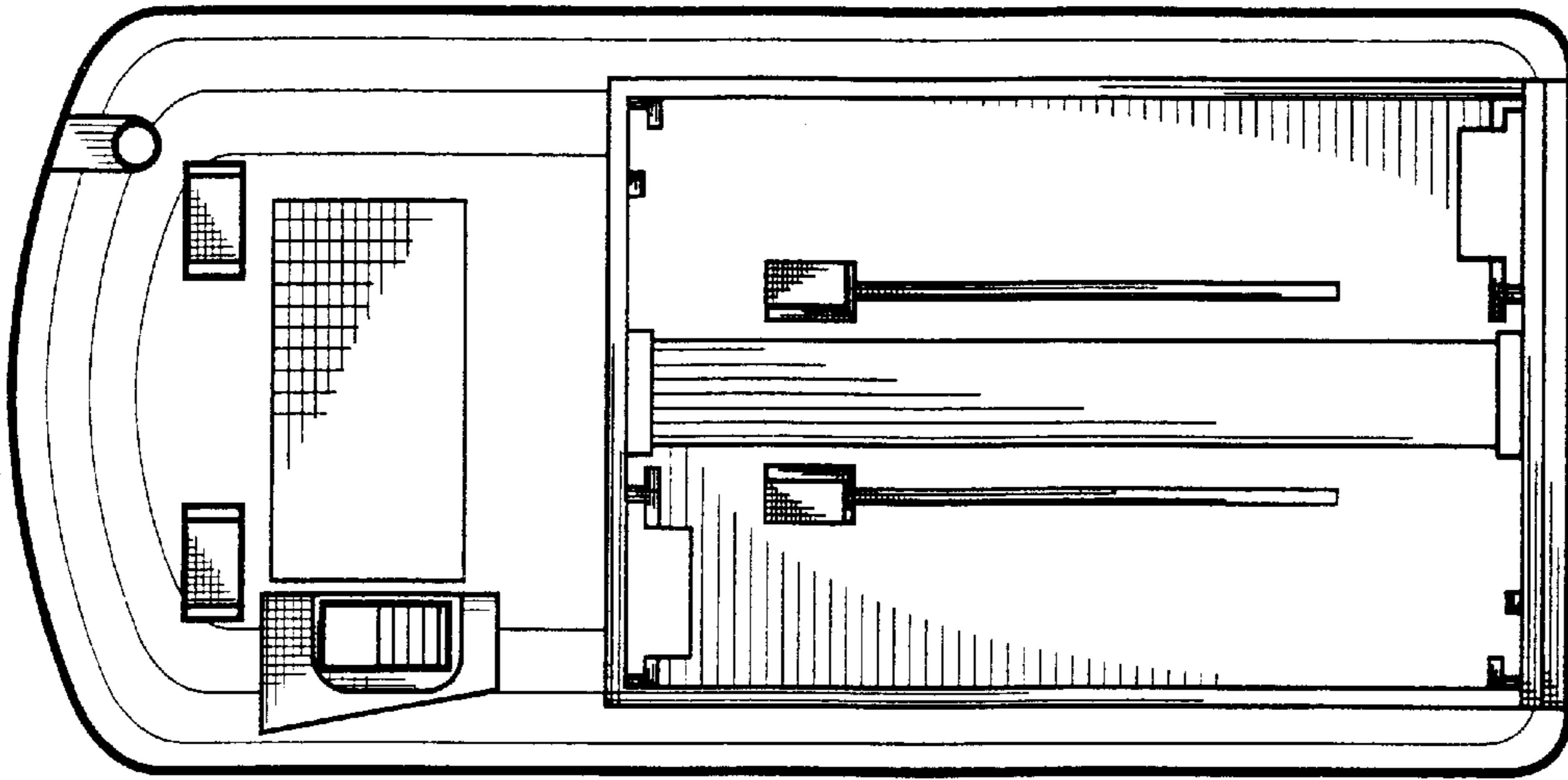

Fig. 4

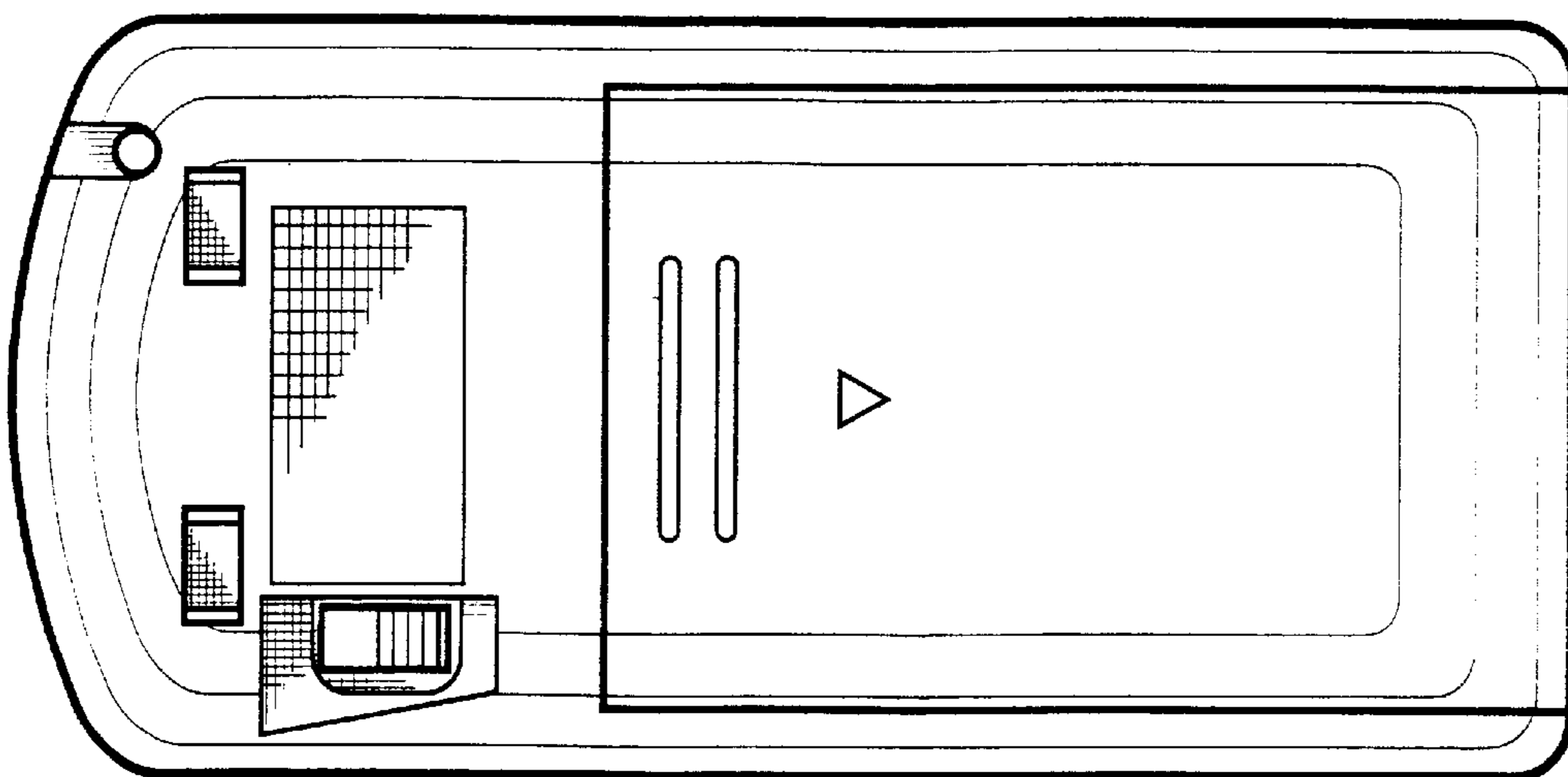

Fig. 3

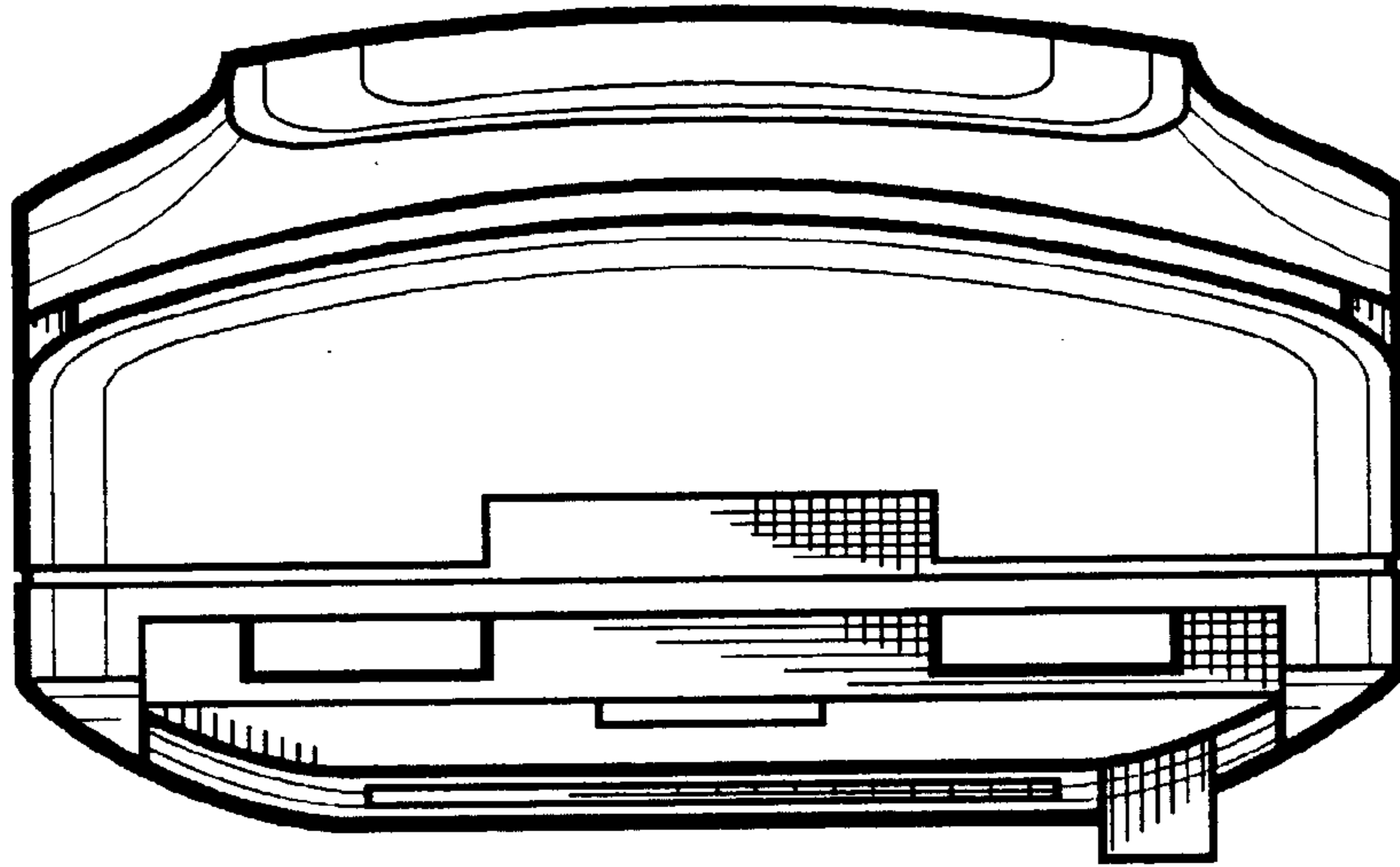

Fig. 5

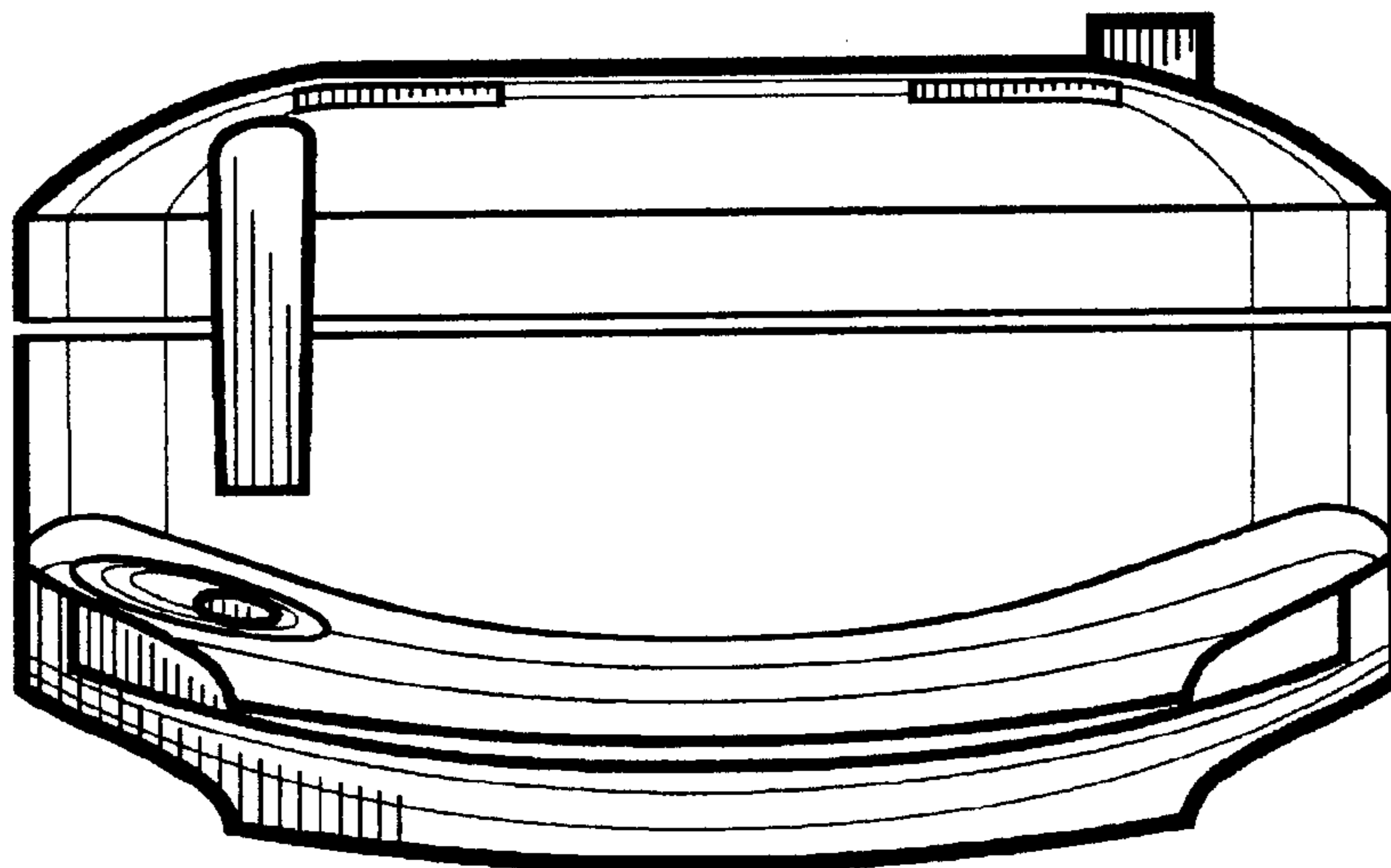

Fig. 6

Fig. 7

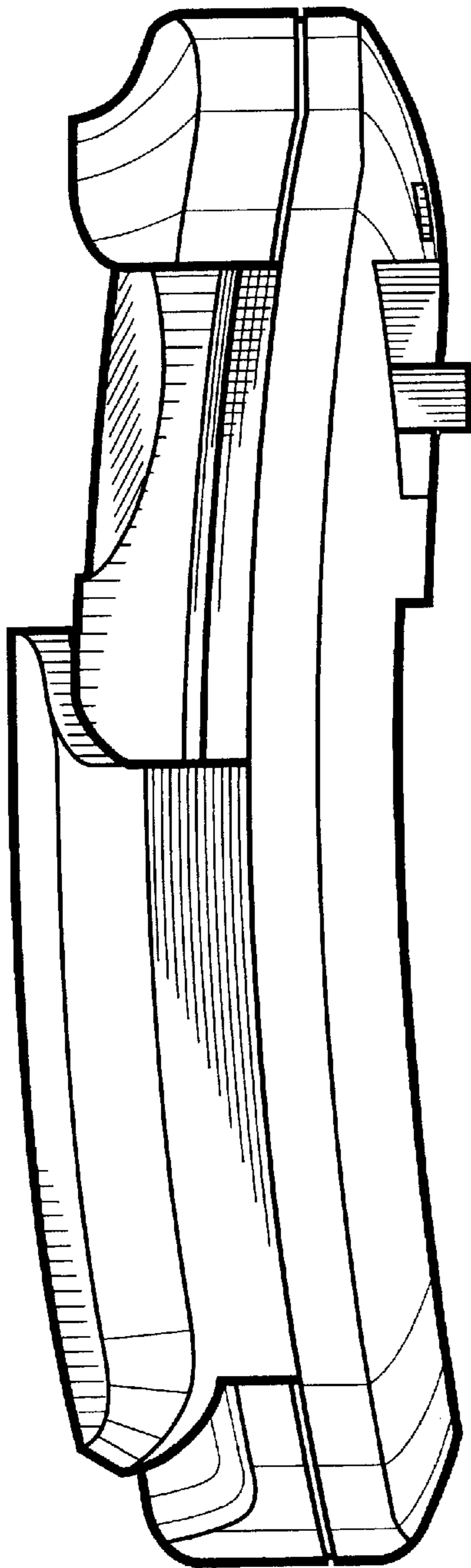
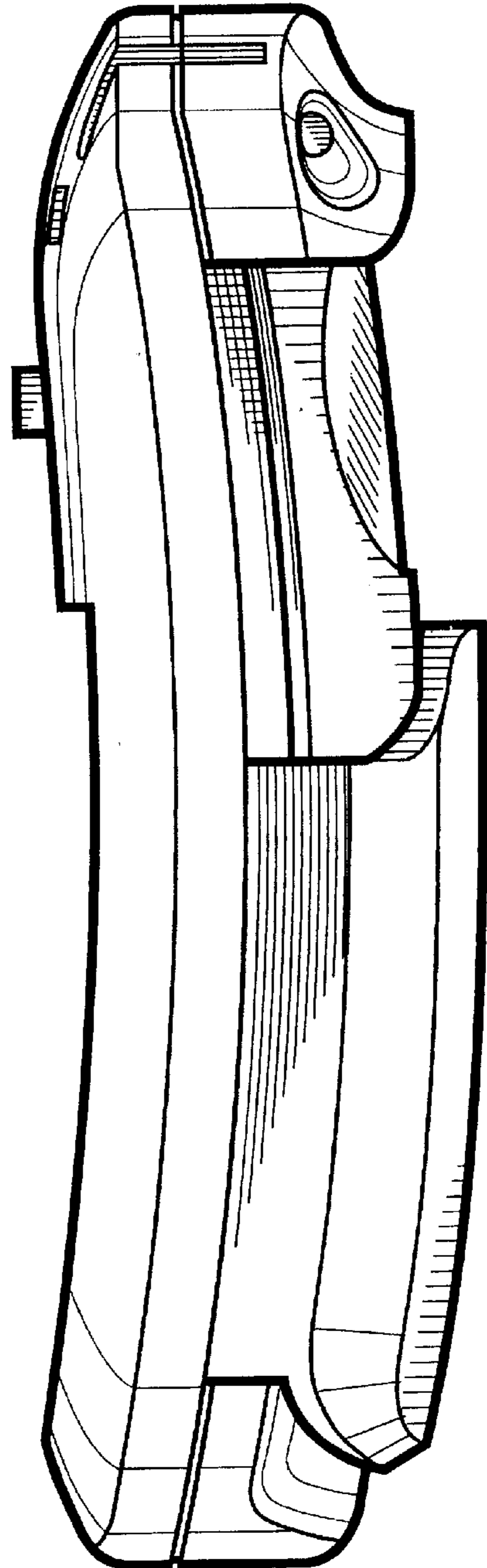

Fig. 8



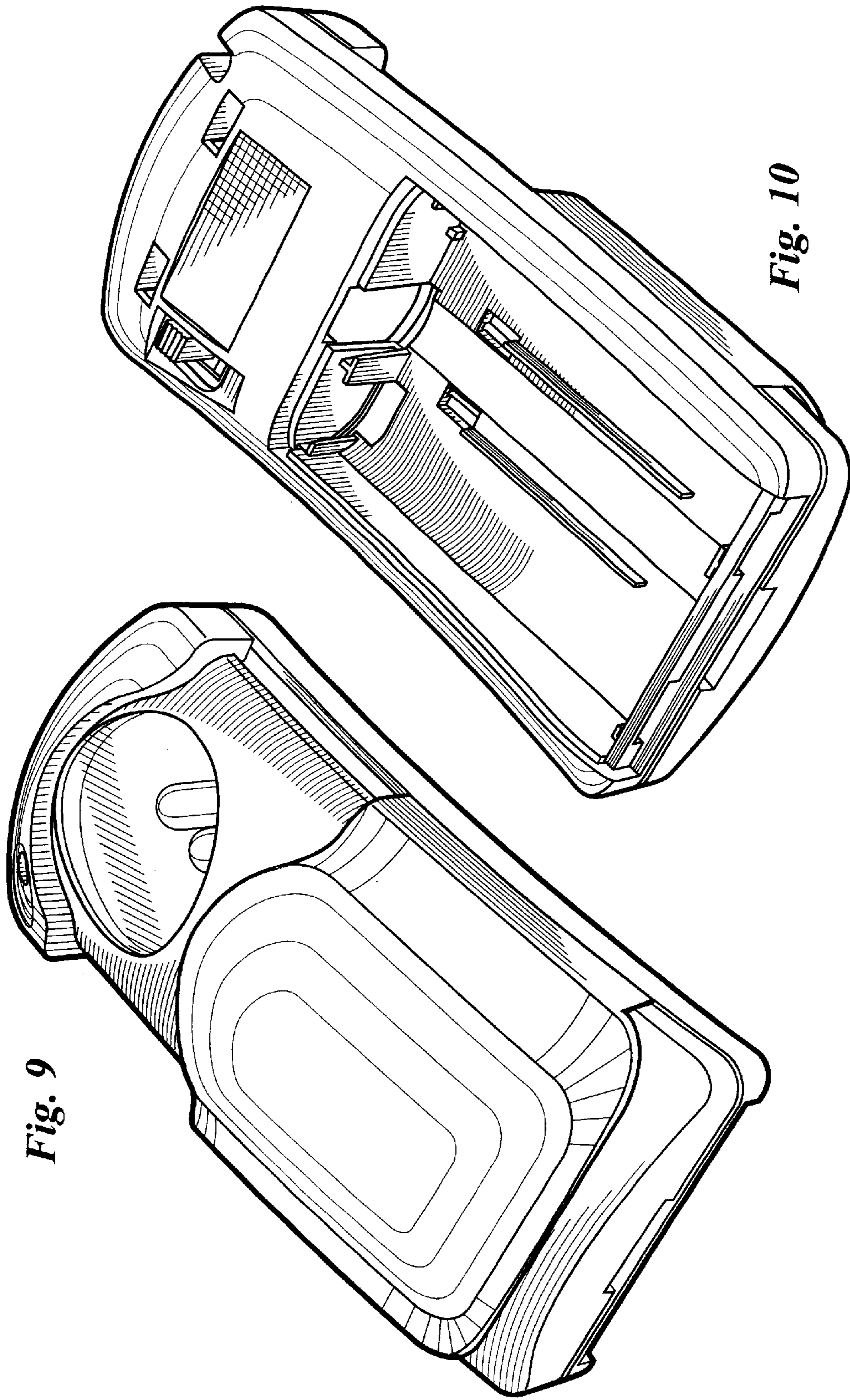

Fig. 9

Fig. 10

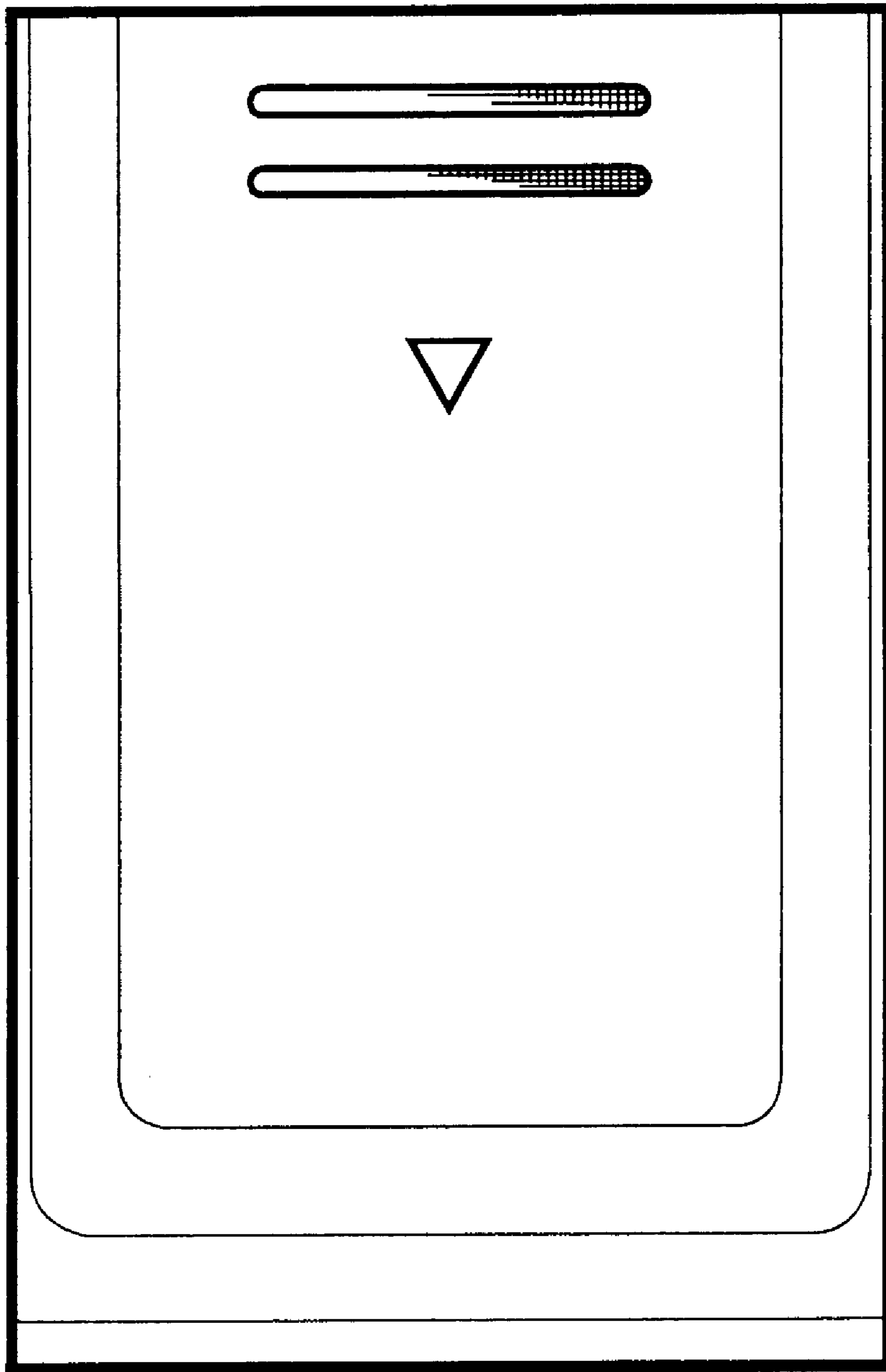

Fig. 11