



US00D480488S

(12) **United States Design Patent**  
**Shih**

(10) **Patent No.:** **US D480,488 S**

(45) **Date of Patent:** **\*\* Oct. 7, 2003**

(54) **AUTOMOBILE LIGHT**

D476,099 \* 6/2003 Zin ..... D26/28

(75) **Inventor:** **Chien-Wen Shih, Tainan (TW)**

\* cited by examiner

(73) **Assignee:** **TYC Brother Industrial Co., Ltd.,  
Tainan (TW)**

*Primary Examiner*—Marcus A. Jackson

(74) *Attorney, Agent, or Firm*—Fitzpatrick, Cella, Harper & Scinto

(\*\*) **Term:** **14 Years**

(57) **CLAIM**

(21) **Appl. No.:** **29/176,044**

The ornamental design for automobile light, as shown and described.

(22) **Filed:** **Feb. 19, 2003**

(51) **LOC (7) Cl.** ..... **26-06**

(52) **U.S. Cl.** ..... **D26/28**

(58) **Field of Search** ..... D26/28-36, 120,  
D26/122; 362/61, 80, 81, 82, 83, 83.4,  
267, 269, 275, 330-340

**DESCRIPTION**

FIG. 1 is a perspective view of automobile light showing the new design;

FIG. 2 is a front elevational view thereof;

FIG. 3 is a rear elevational thereof;

FIG. 4 is a left side elevational view thereof;

FIG. 5 is a right side elevational view thereof;

FIG. 6 is a top plan view thereof; and,

FIG. 7 is a bottom plan view thereof.

(56) **References Cited**

**U.S. PATENT DOCUMENTS**

D474,289 S \* 6/2003 Zin ..... D26/28

D475,475 S \* 6/2003 Zin ..... D26/28

**1 Claim, 4 Drawing Sheets**

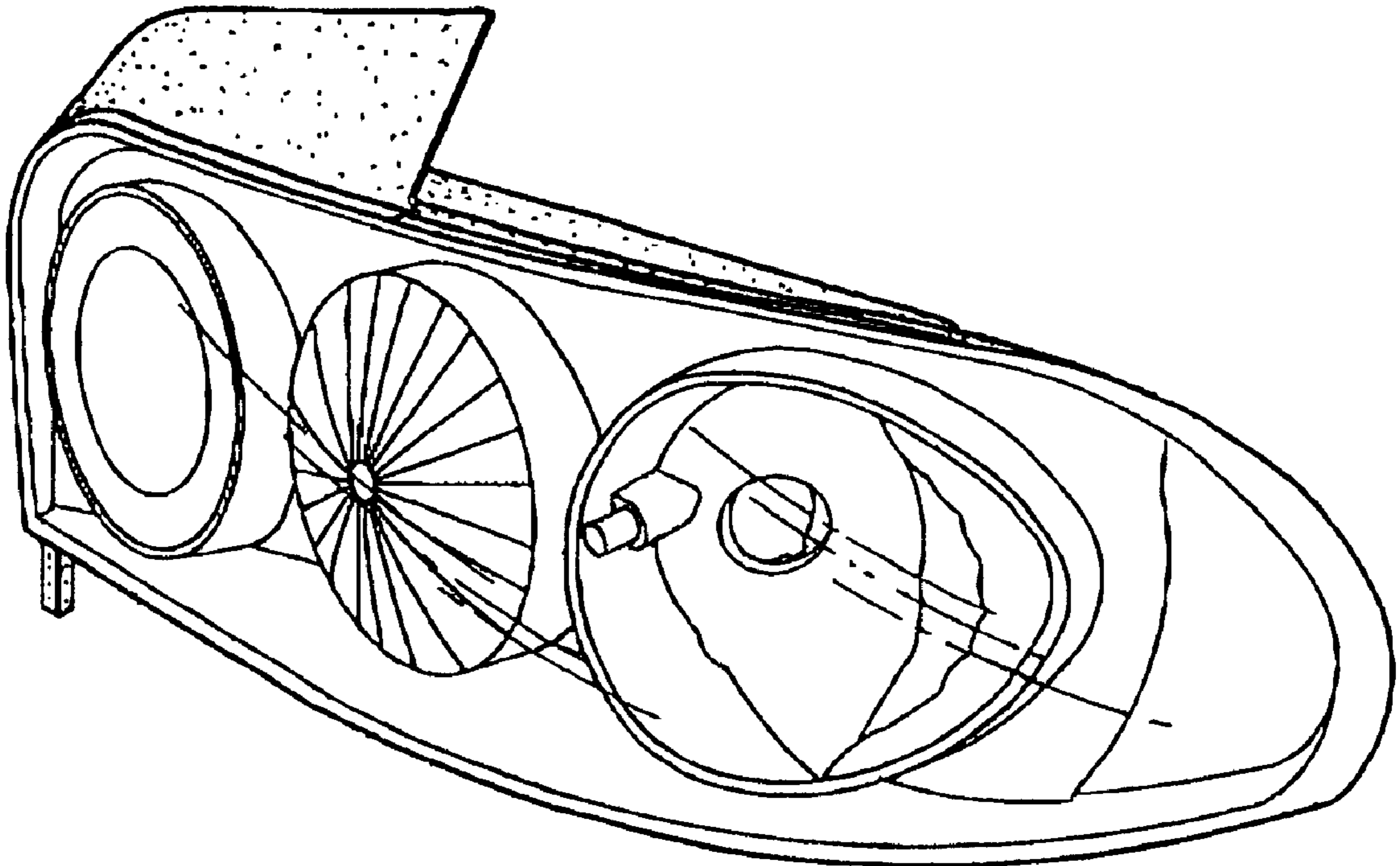

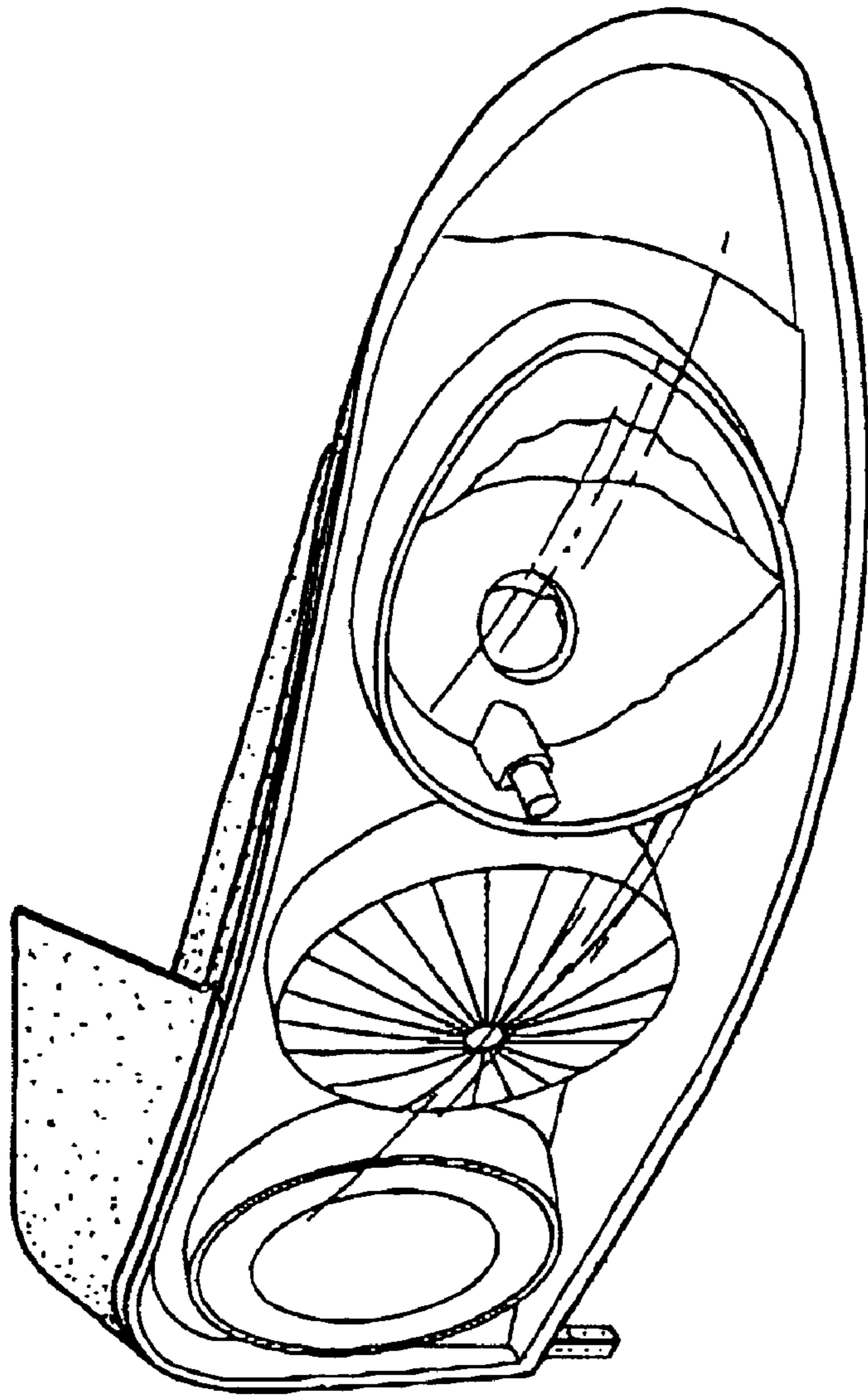

FIG. 1

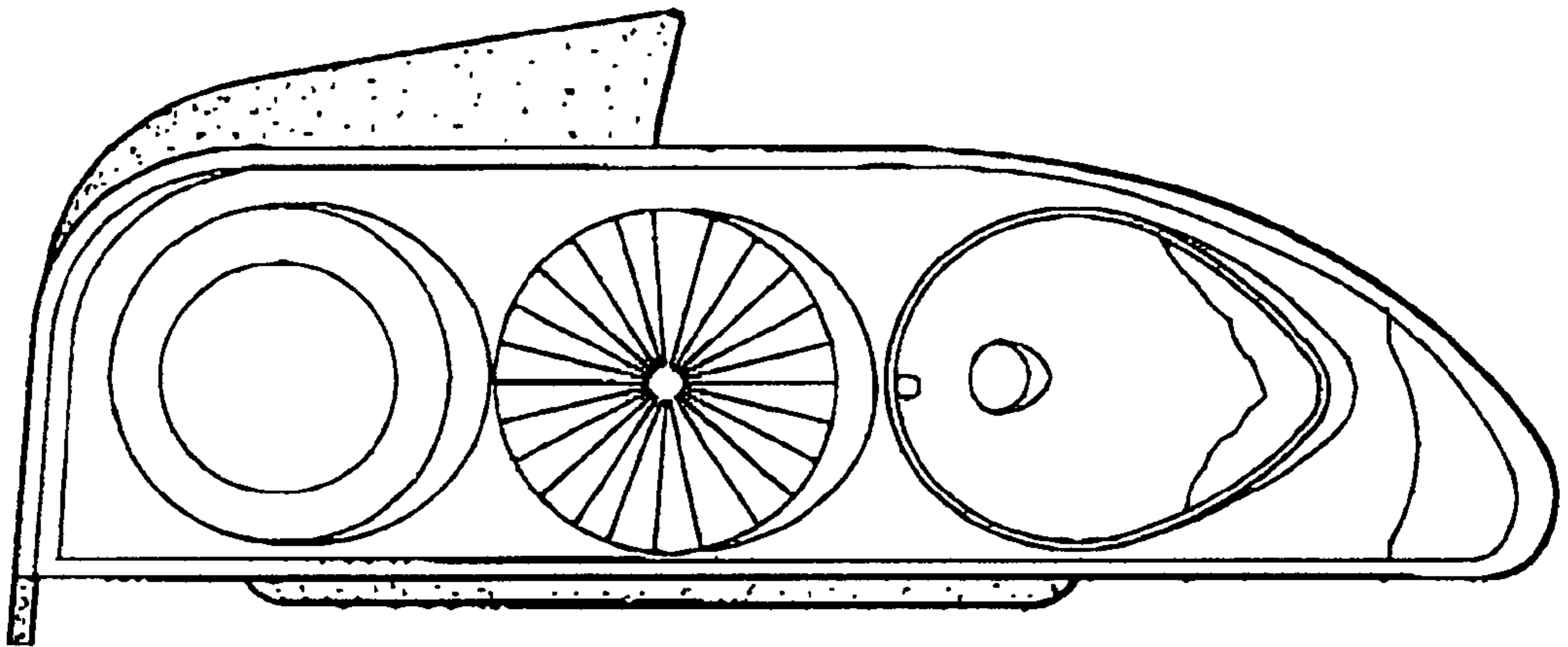

FIG. 2

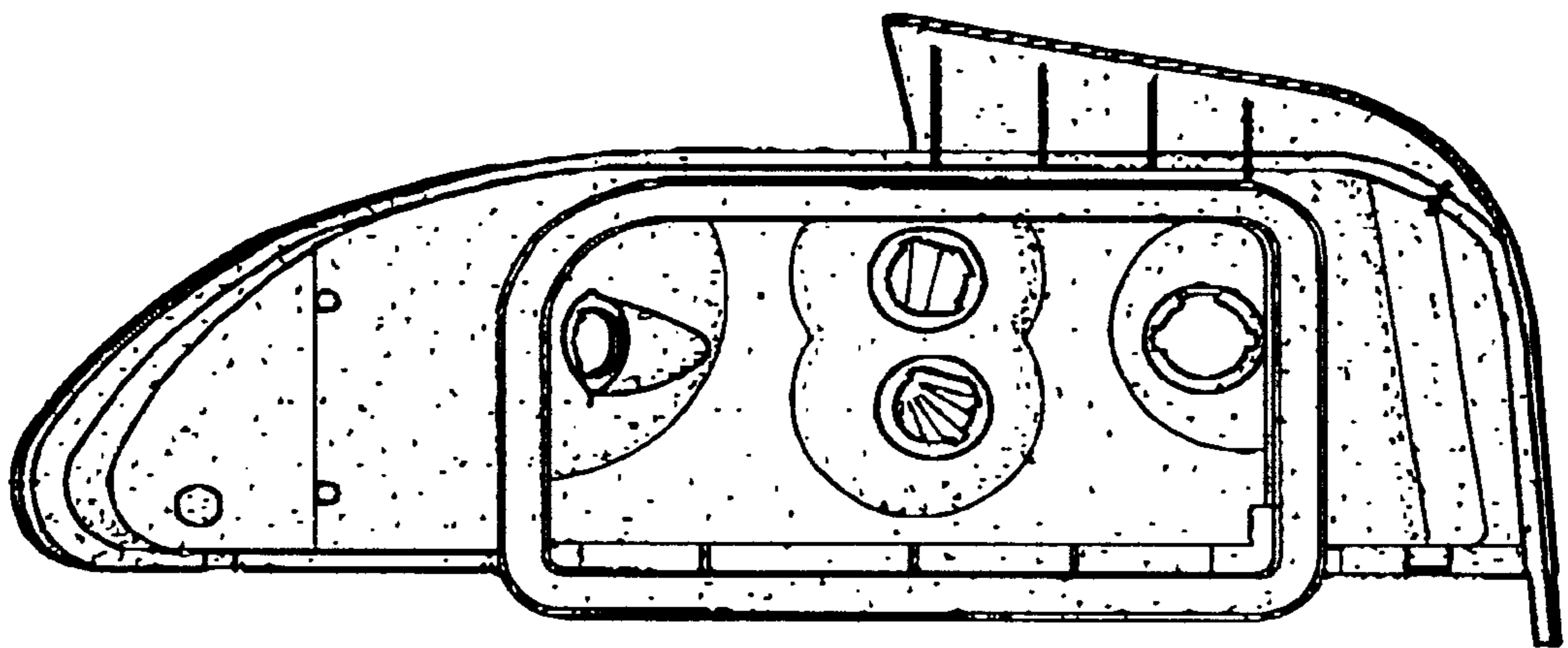

FIG. 3

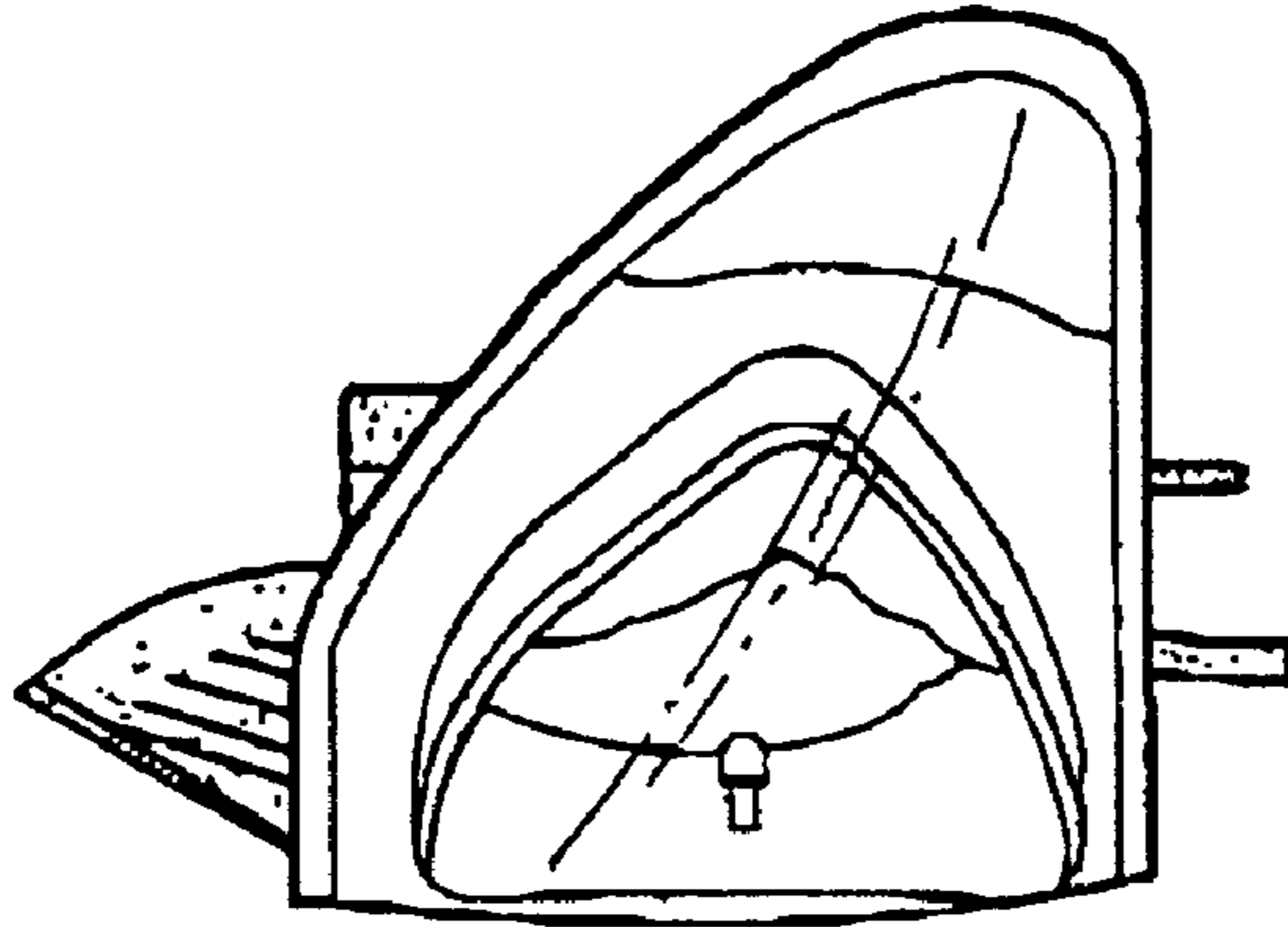

FIG. 5

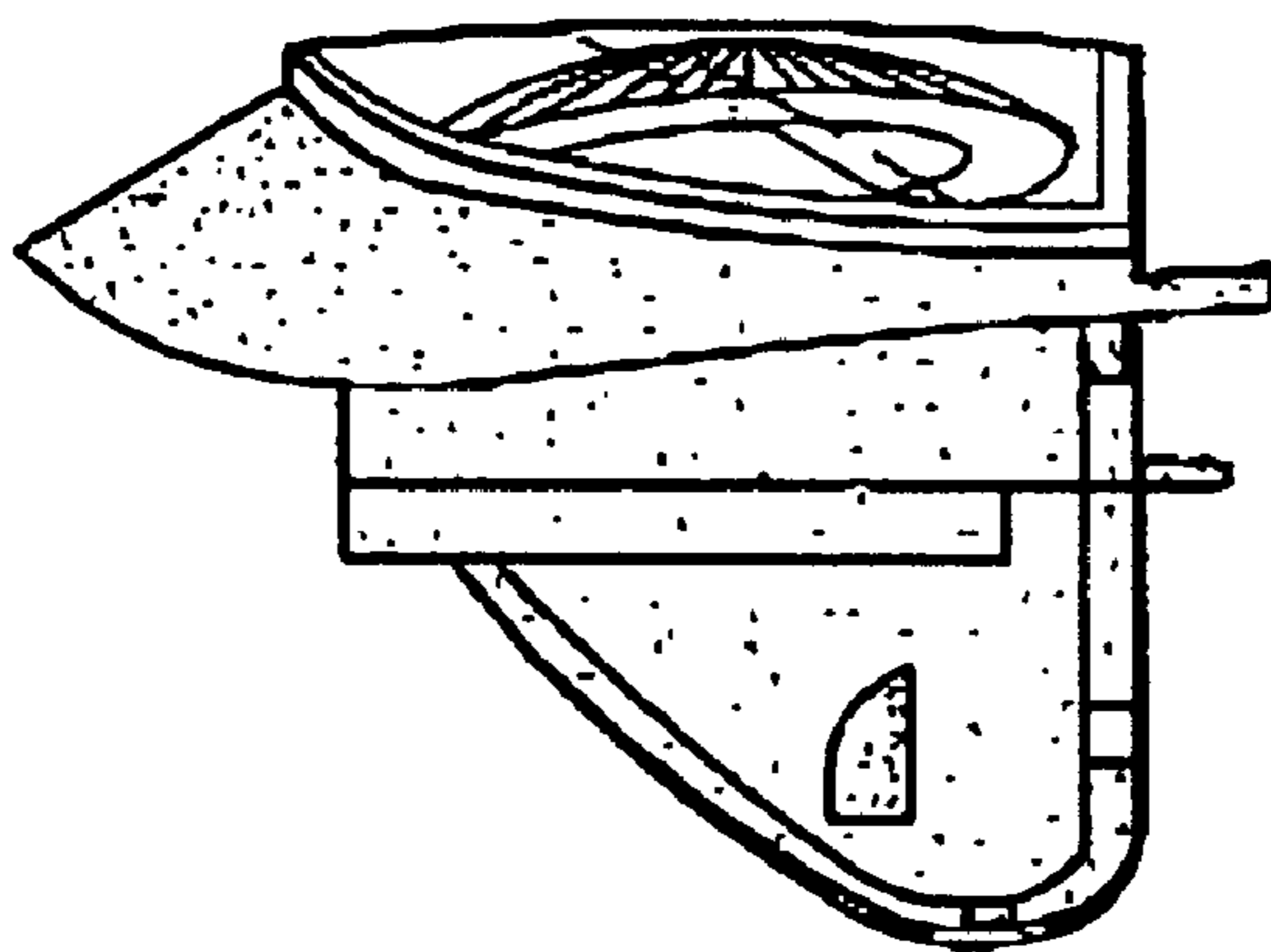

FIG. 4

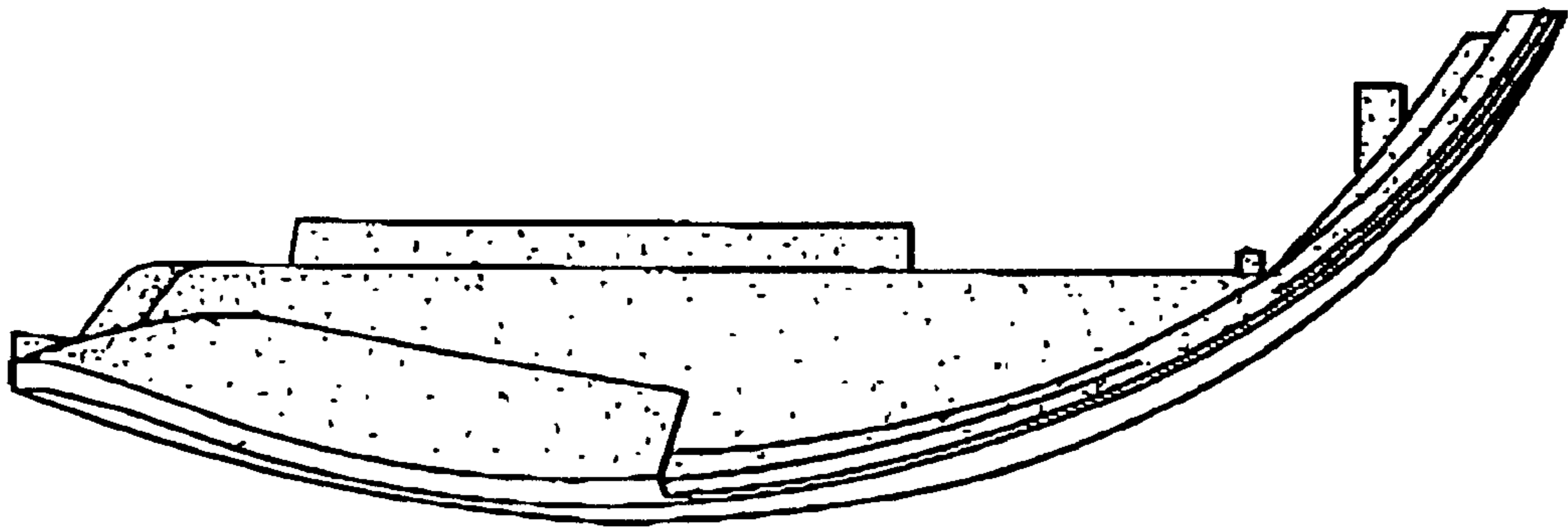

FIG. 6

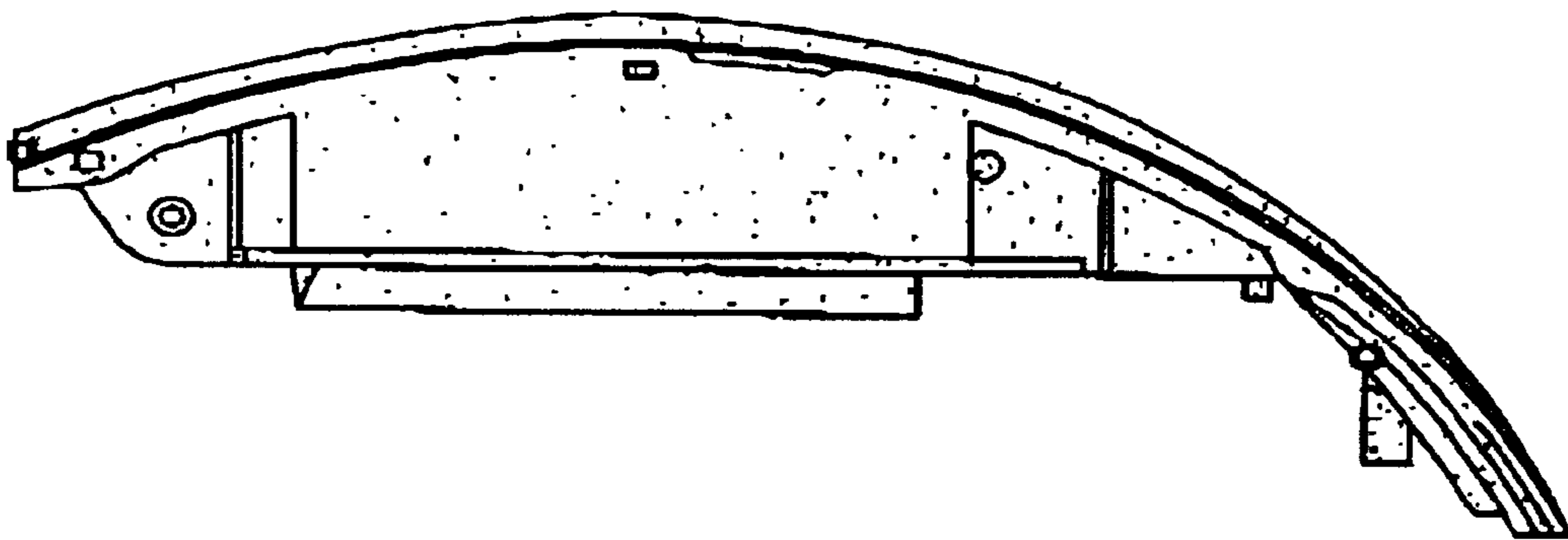

FIG. 7