



US00D480446S

(12) **United States Design Patent**
Liou

(10) **Patent No.:** **US D480,446 S**

(45) **Date of Patent:** **** Oct. 7, 2003**

(54) **COAXIAL LIQUID PRESSURIZED MIXER**

(76) Inventor: **Huei-Tarng Liou**, P.O. Box 23-166,
Taipei (TW)

(**) Term: **14 Years**

(21) Appl. No.: **29/147,865**

(22) Filed: **Sep. 6, 2001**

(51) **LOC (7) Cl.** **23-01**

(52) **U.S. Cl.** **D23/207**

(58) **Field of Search** D23/207, 209,
D23/200; 422/186, 186.07; 210/668, 87

(56) **References Cited**

U.S. PATENT DOCUMENTS

5,667,756	A *	9/1997	Ho	422/186.18
6,030,586	A *	2/2000	Kuan	422/186.07
6,331,279	B1 *	12/2001	Martin	422/186.07
6,419,831	B2 *	7/2002	Wang	210/668

* cited by examiner

Primary Examiner—Robin V. Taylor

(74) *Attorney, Agent, or Firm*—Ladas and Parry

(57) **CLAIM**

The ornamental design for a coaxial liquid pressurized mixer, as shown and described.

DESCRIPTION

FIG. 1 is a front elevational view of the subject design;
FIG. 2 is a rear elevational view thereof;
FIG. 3 is a left side elevational view thereof;
FIG. 4 is a right side elevational view thereof;
FIG. 5 is a top plan view thereof;
FIG. 6 is a bottom plan view thereof;
FIG. 7 is a perspective view thereof; and,
FIG. 8 is an enlarged top plan view thereof showing the legs
in folding condition.

1 Claim, 8 Drawing Sheets

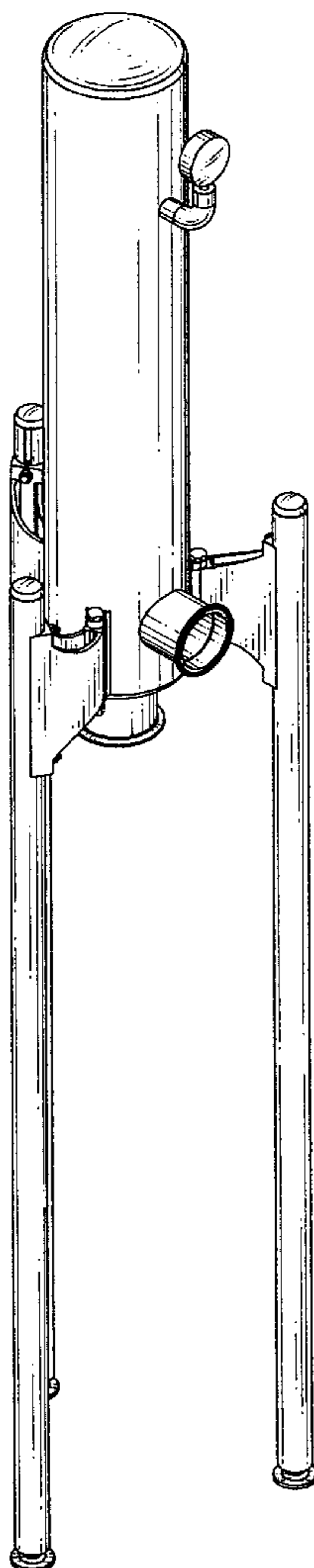

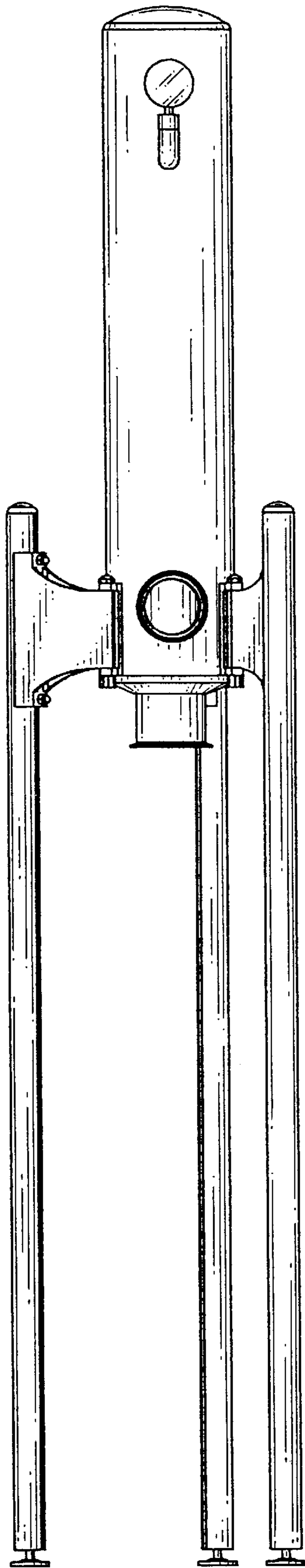

FIG. 1

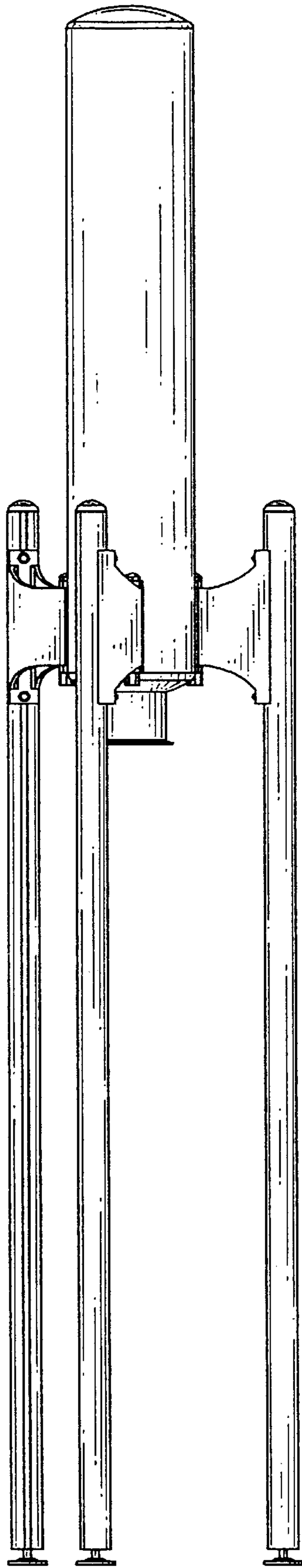

FIG.2

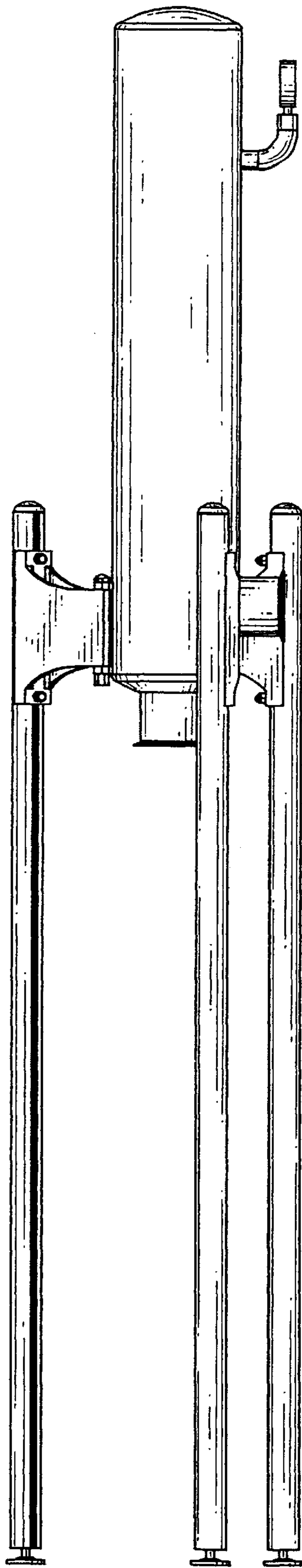

FIG.3

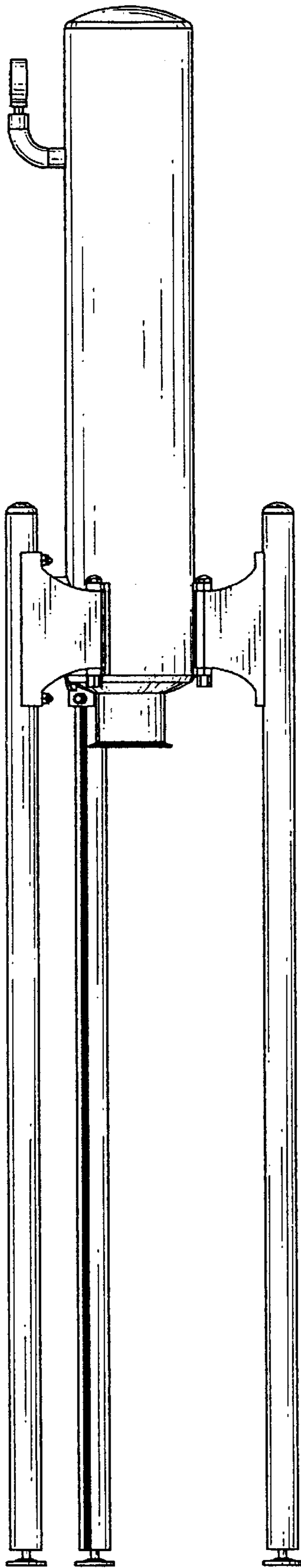

FIG.4

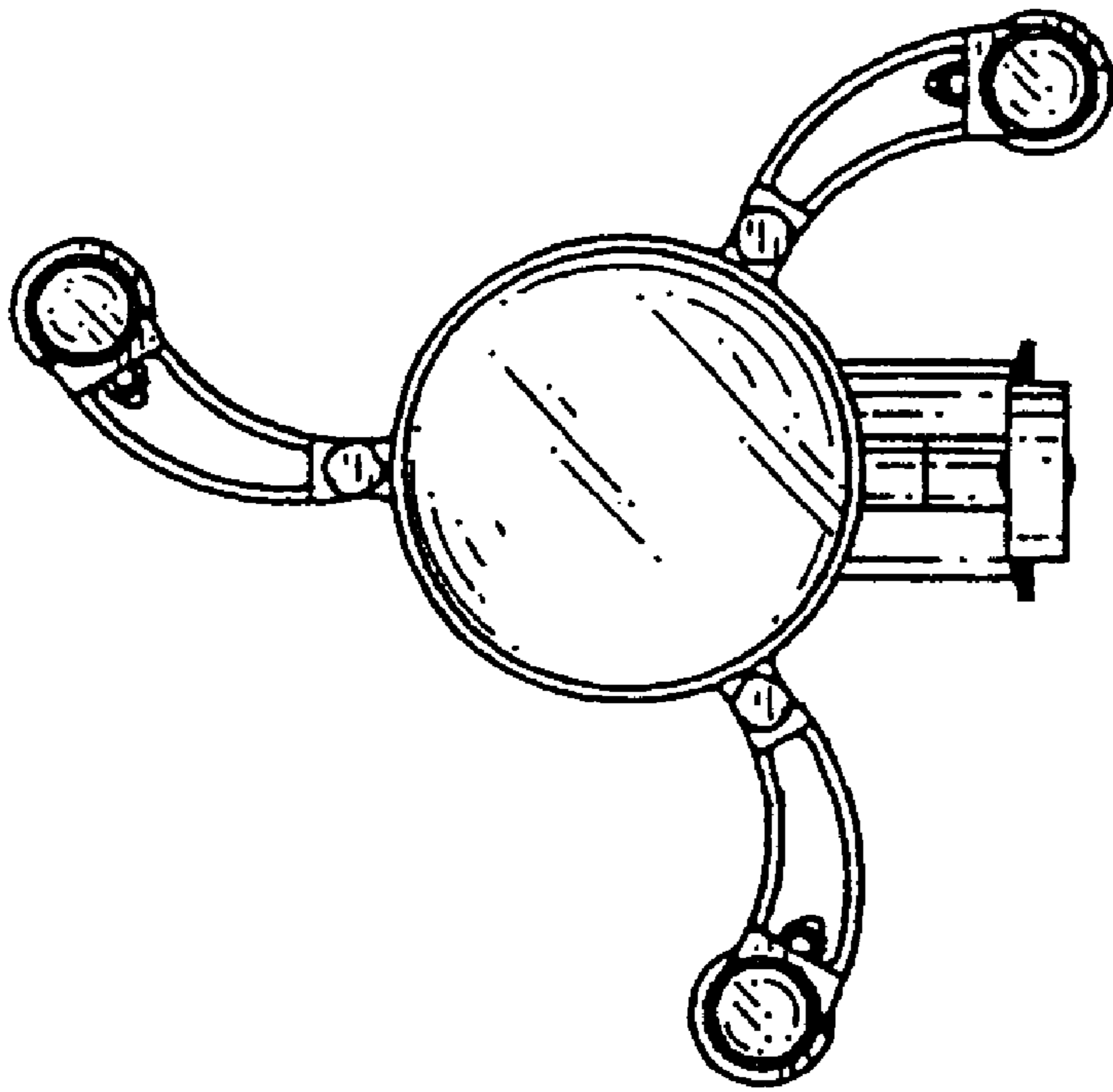

FIG. 5

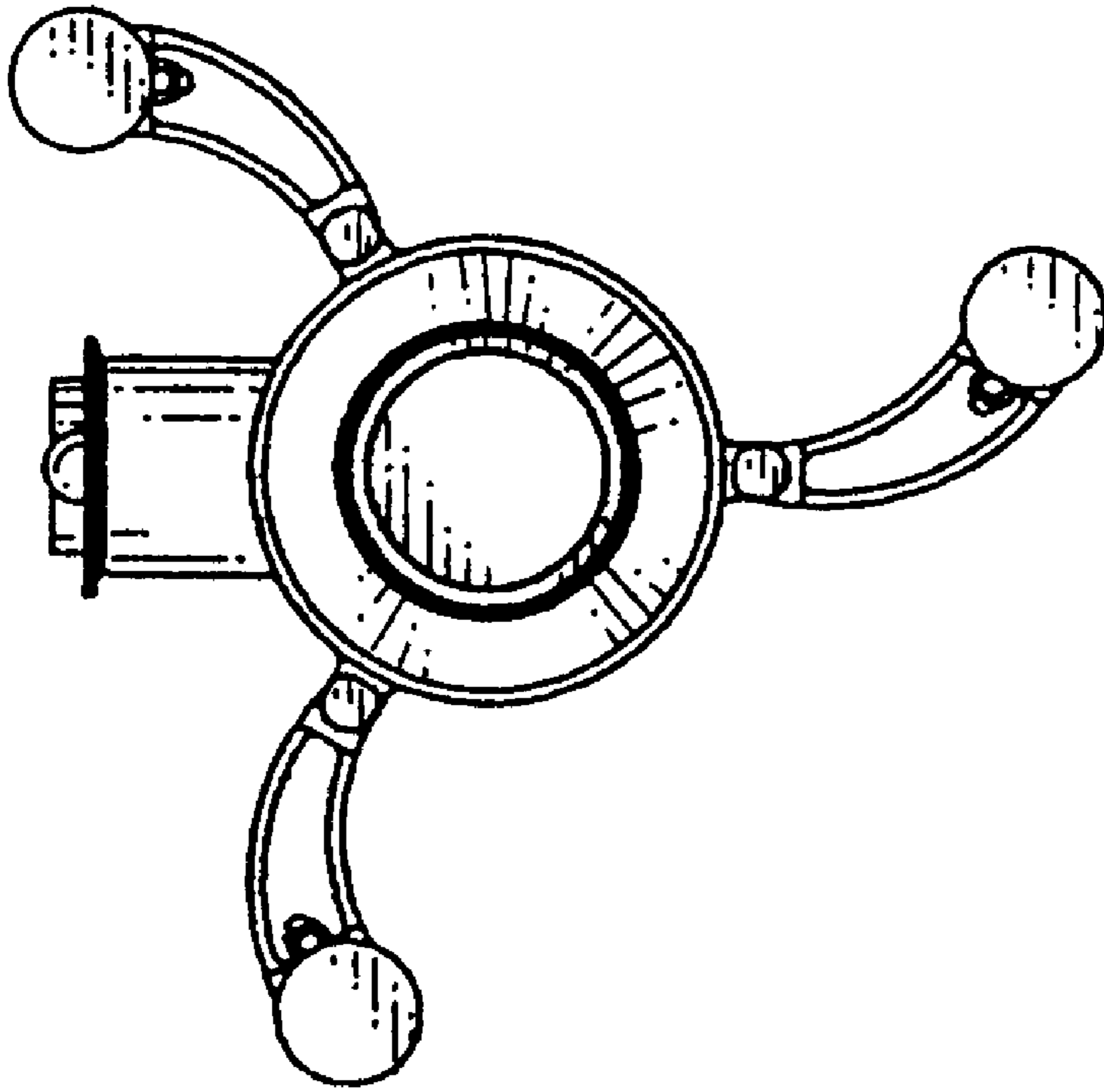

FIG.6

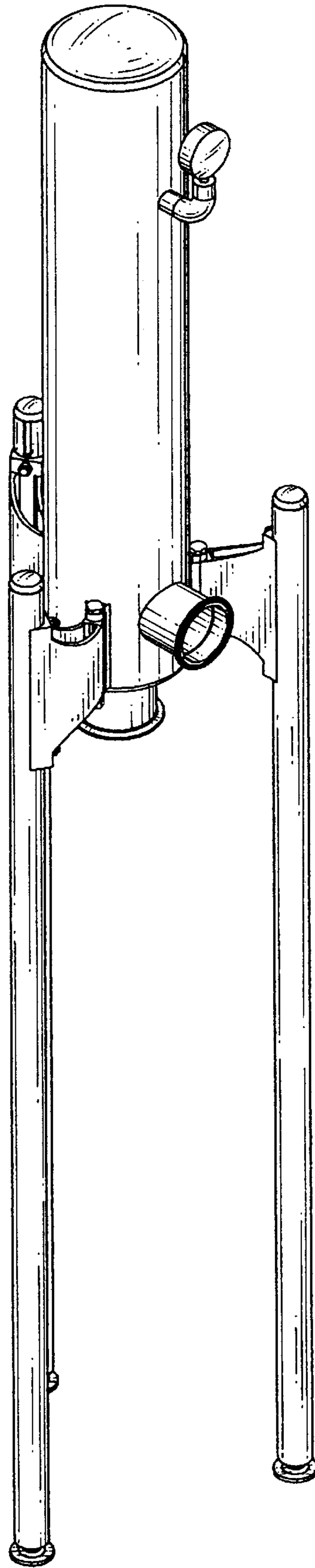

FIG. 7

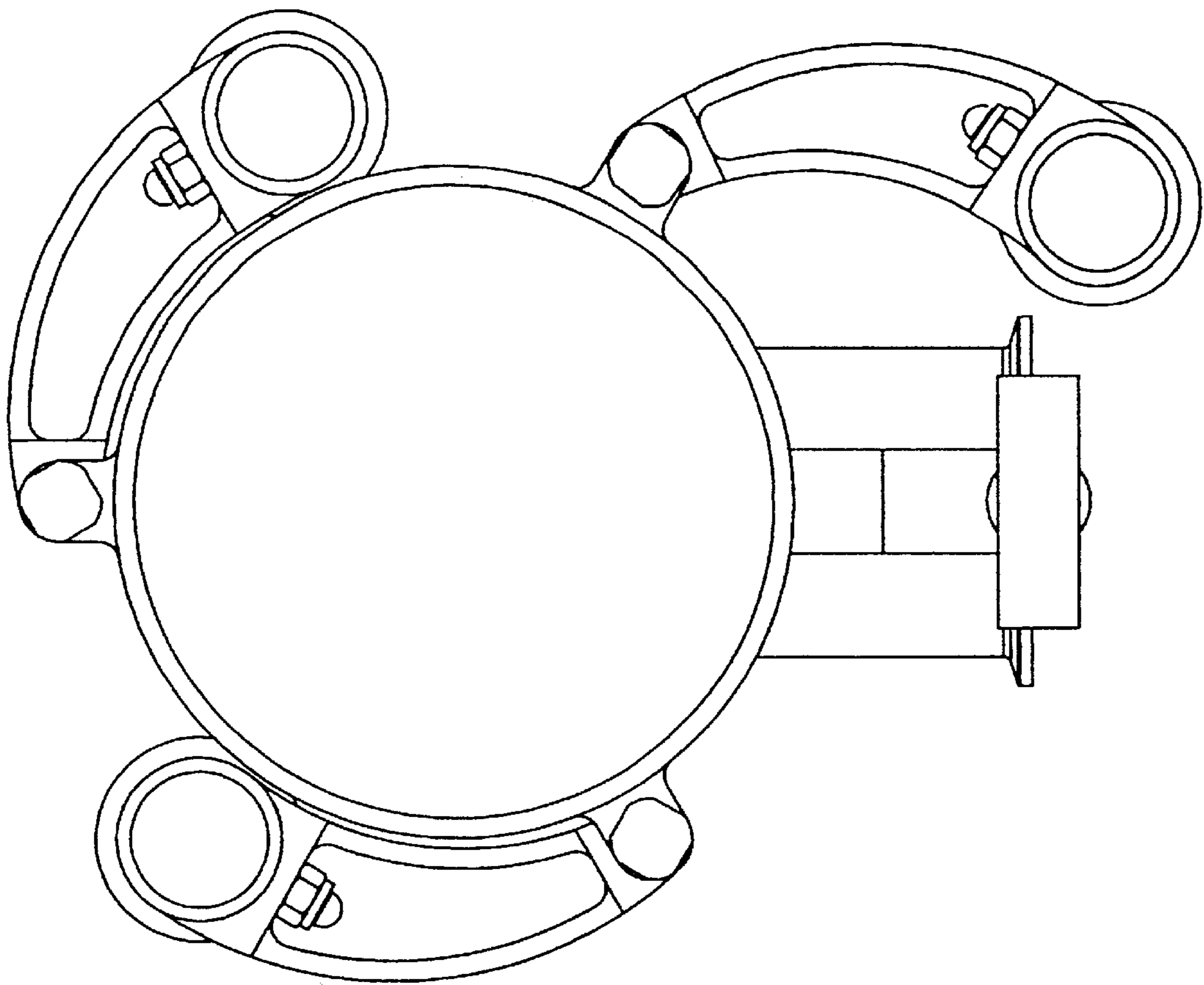

FIG. 8