



US00D480313S

(12) **United States Design Patent**
Johnson et al.

(10) **Patent No.:** **US D480,313 S**

(45) **Date of Patent:** **** Oct. 7, 2003**

(54) **BOTTLE**

(75) Inventors: **Stephen M. Johnson**, Huntington Beach, CA (US); **Joseph J. Bruchman**, Mission Viejo, CA (US)

(73) Assignee: **Setco, Inc.**, Anaheim, CA (US)

(**) Term: **14 Years**

(21) Appl. No.: **29/154,950**

(22) Filed: **Jan. 31, 2002**

(51) **LOC (7) Cl.** **09-01**

(52) **U.S. Cl.** **D9/538**

(58) **Field of Search** D9/500, 502, 516, D9/530, 537-543, 549, 552, 554, 556, 558-559, 565, 569, 574-575; 215/373, 382-385, 396, 398, 400; 220/667

(56) **References Cited**

U.S. PATENT DOCUMENTS

- D315,869 S * 4/1991 Collette D9/551
- 5,704,503 A * 1/1998 Krishnakumar et al. 215/381
- D393,802 S * 4/1998 Collette et al. D9/502
- D411,453 S * 6/1999 Piccioli et al. D9/538 X
- 5,908,128 A * 6/1999 Krishnakumar et al. 215/381
- 6,016,932 A * 1/2000 Gaydosh et al. 215/382
- D445,033 S * 7/2001 Bretz et al. D9/538 X
- D445,693 S * 7/2001 Rashid D9/538

- D445,694 S * 7/2001 Gans D9/538
- D446,458 S * 8/2001 Gans D9/538
- D451,401 S * 12/2001 Silvers et al. D9/538
- 6,460,714 B1 * 10/2002 Silvers et al. 215/381
- D466,019 S * 11/2002 Thierjung et al. D9/502
- D466,021 S * 11/2002 Thierjung et al. D9/538

* cited by examiner

Primary Examiner—Ted Shooman

Assistant Examiner—Carol Rademaker

(74) *Attorney, Agent, or Firm*—Timothy Thut Tyson; Freilich, Hornbaker & Rosen

(57) **CLAIM**

The ornamental design for a bottle, as shown.

DESCRIPTION

FIG. 1 is a top side perspective view of a bottle showing my new design;
 FIG. 2 is a bottom side perspective view thereof;
 FIG. 3 is a side elevation view thereof;
 FIG. 4 is a side elevation view thereof rotated 90° from FIG. 3;
 FIG. 5 is a sectional view thereof along line 5—5 of FIG. 5;
 FIG. 6 is a top plan view thereof;
 FIG. 7 is a sectional view thereof along line 7—7 of FIG. 6;
 and,
 FIG. 8 is a bottom plan view thereof.

1 Claim, 3 Drawing Sheets

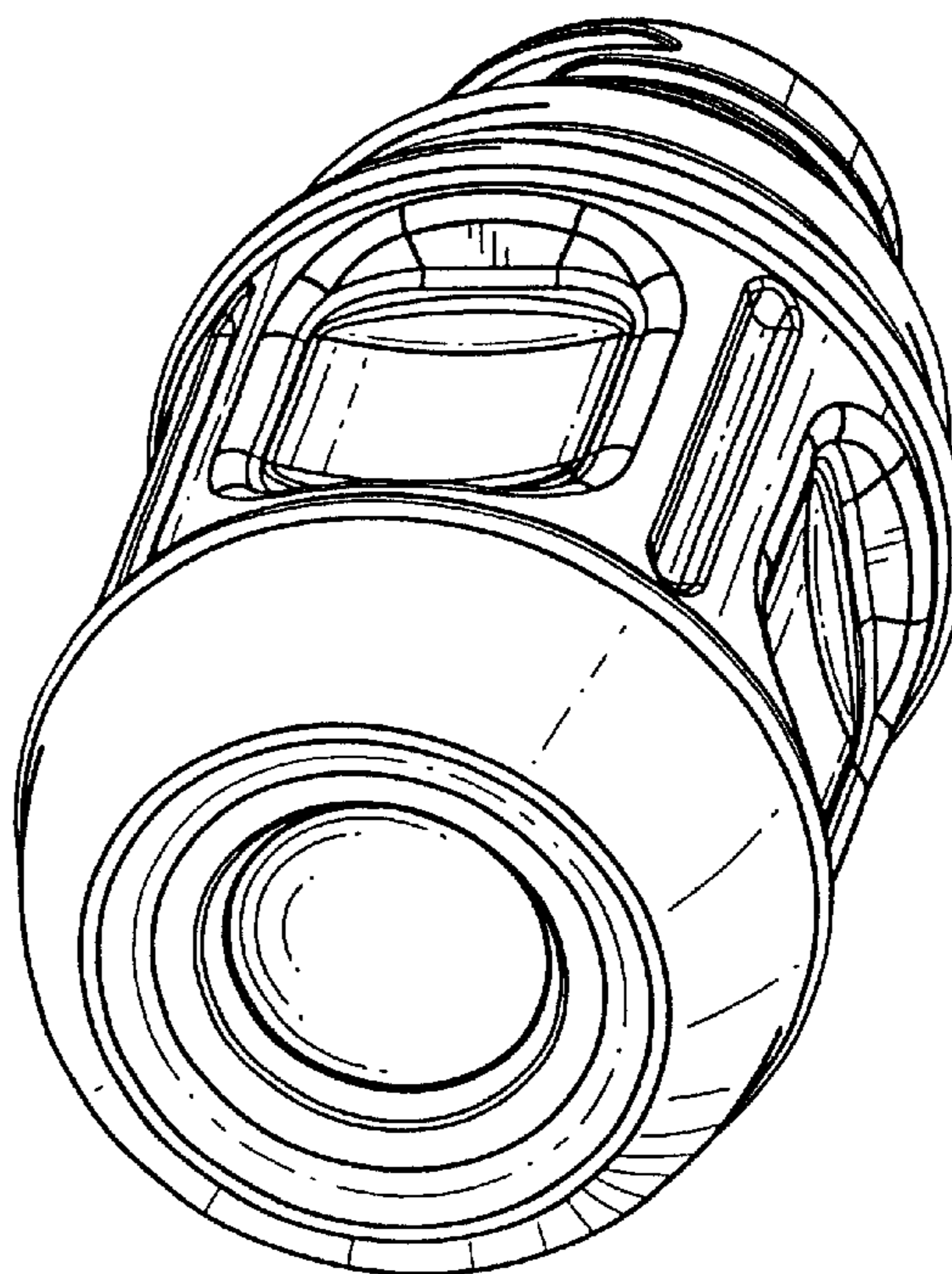
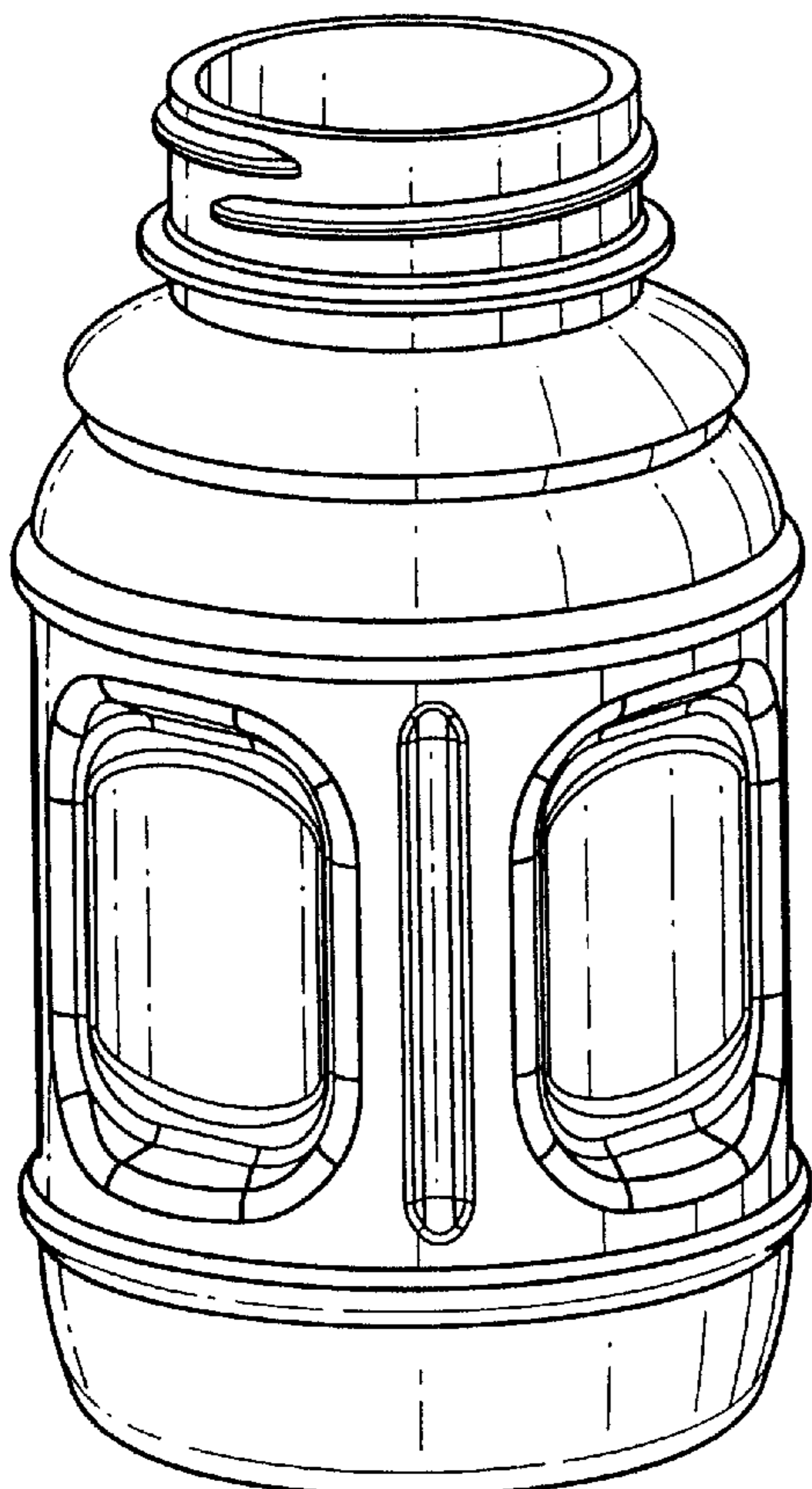

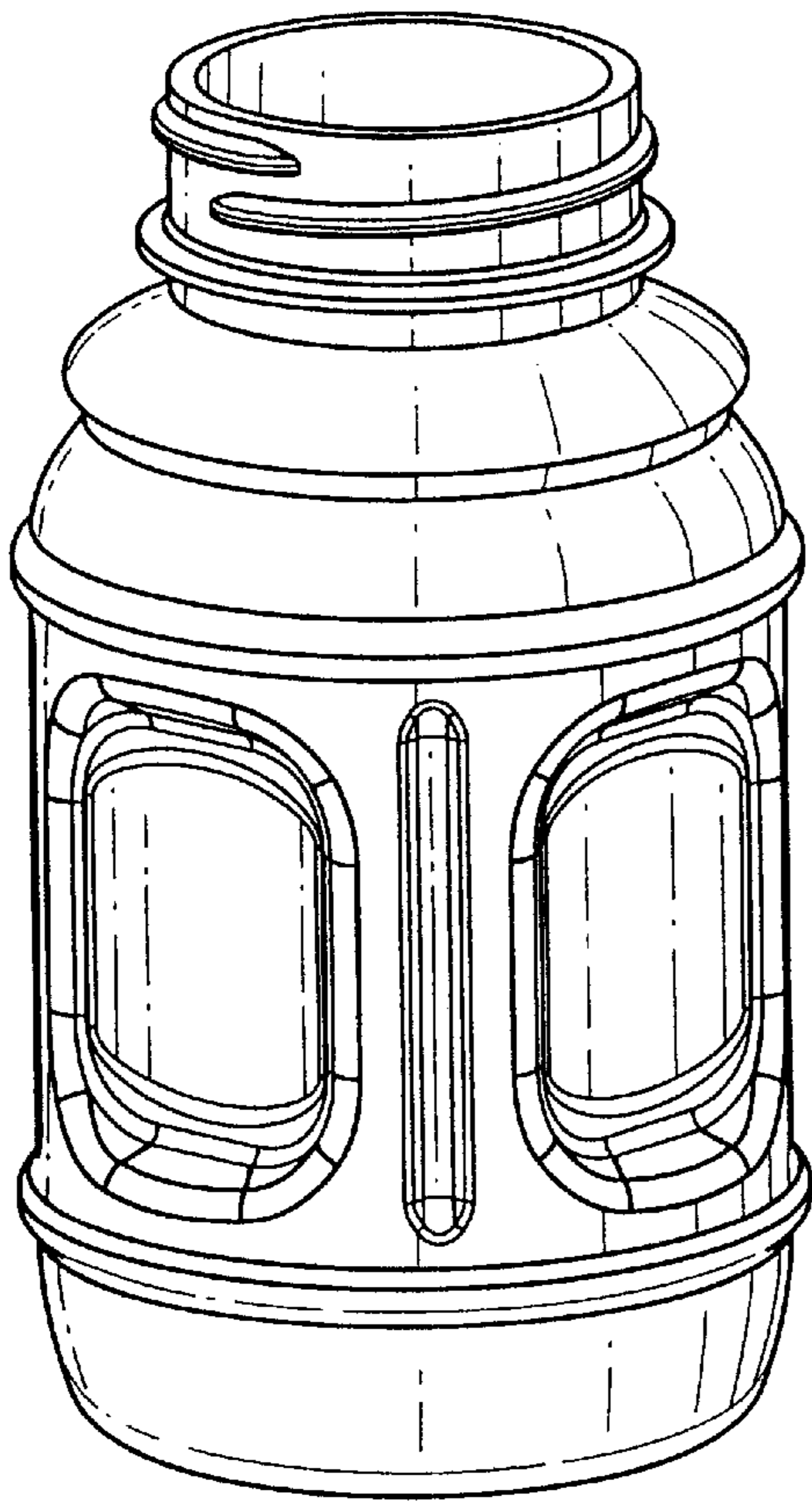

FIG. 1

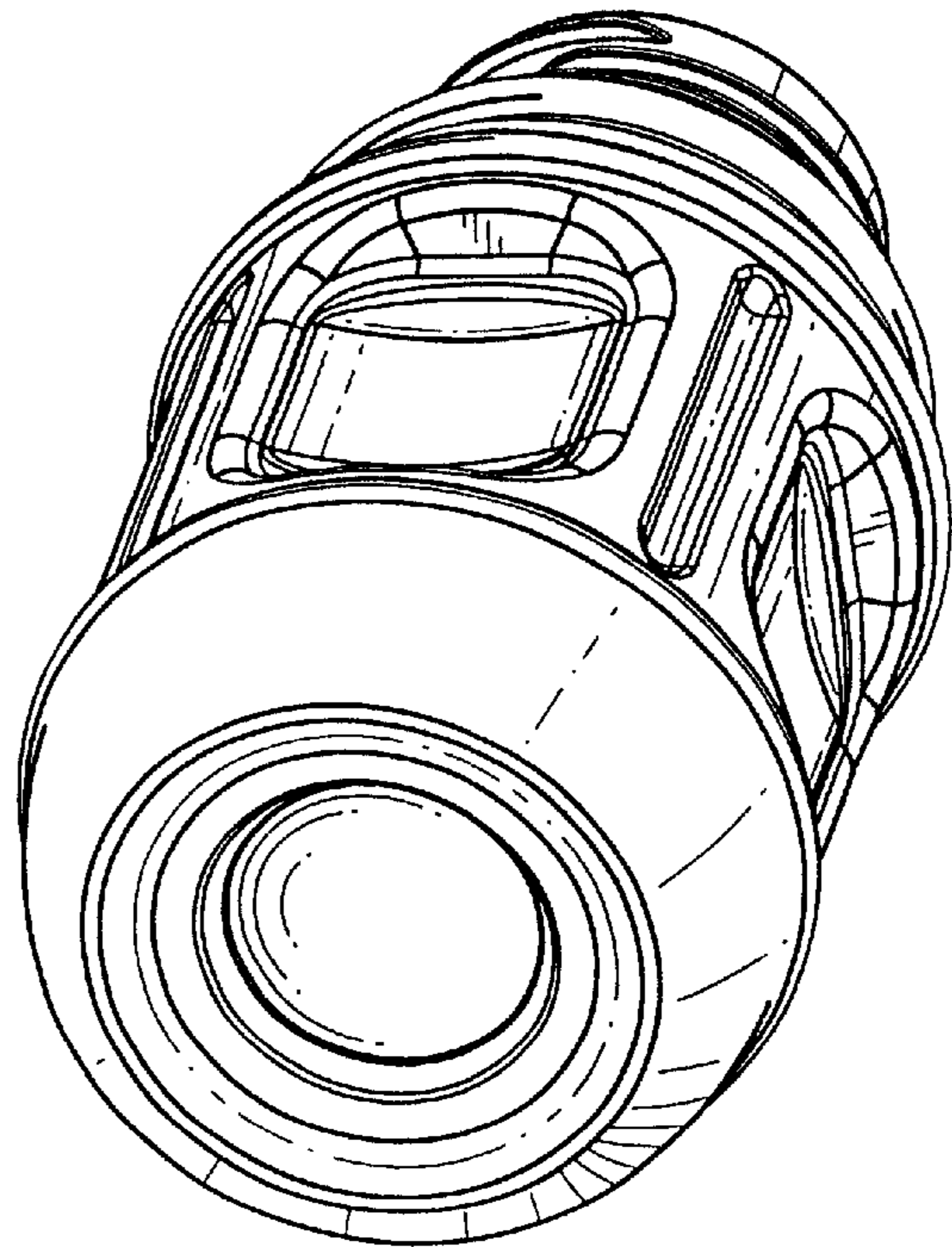

FIG. 2

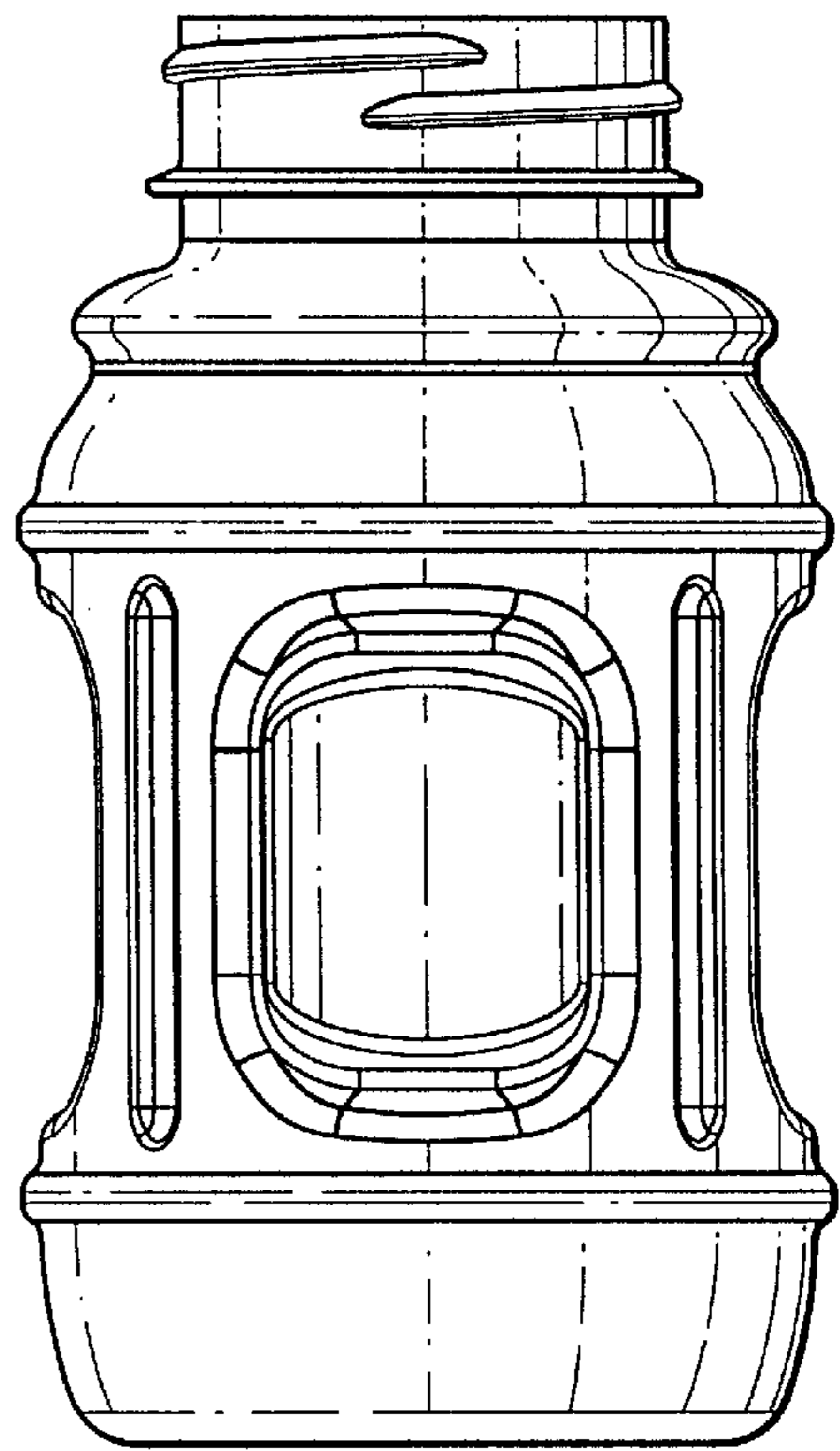

FIG. 3

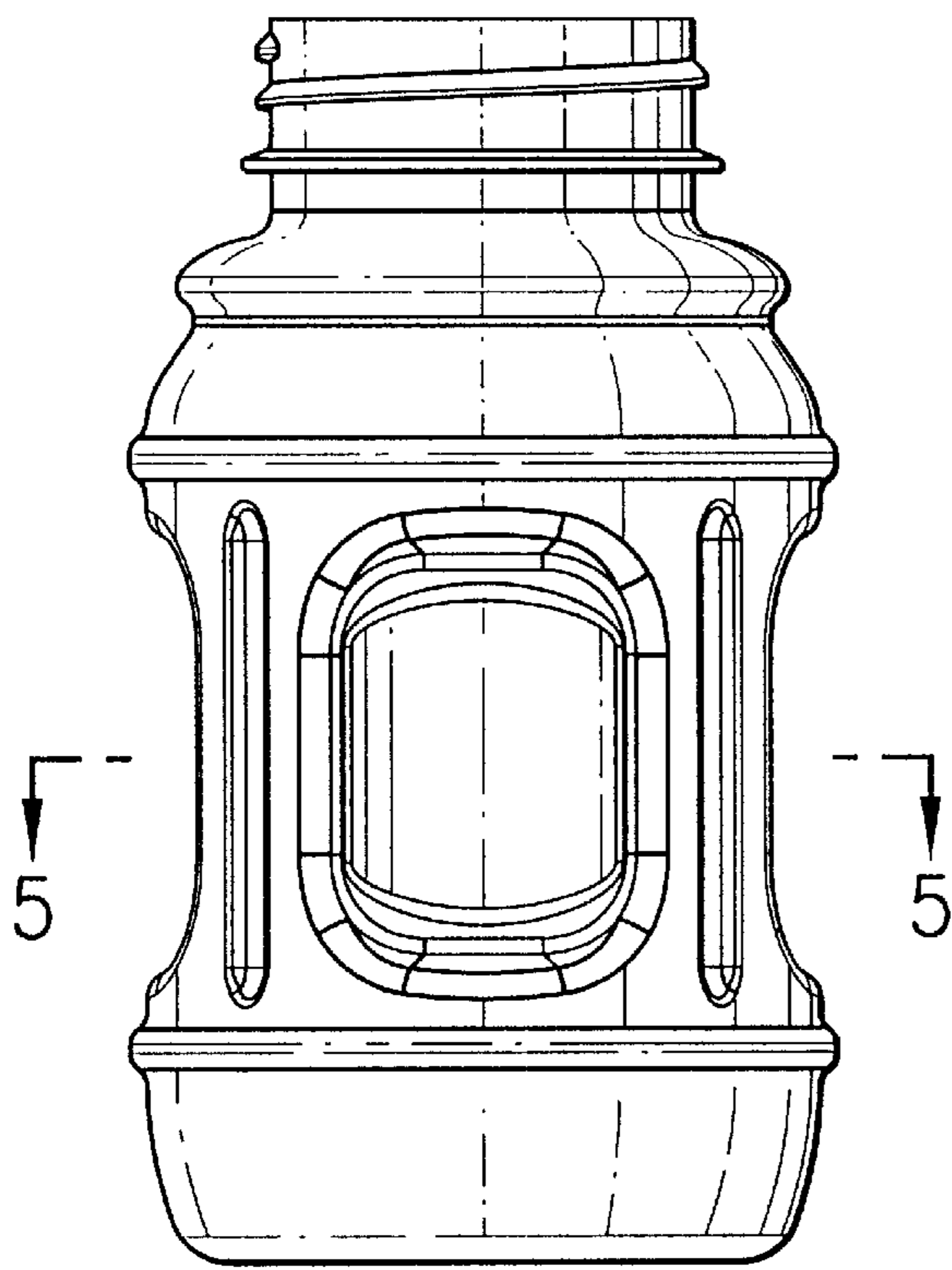

FIG. 4

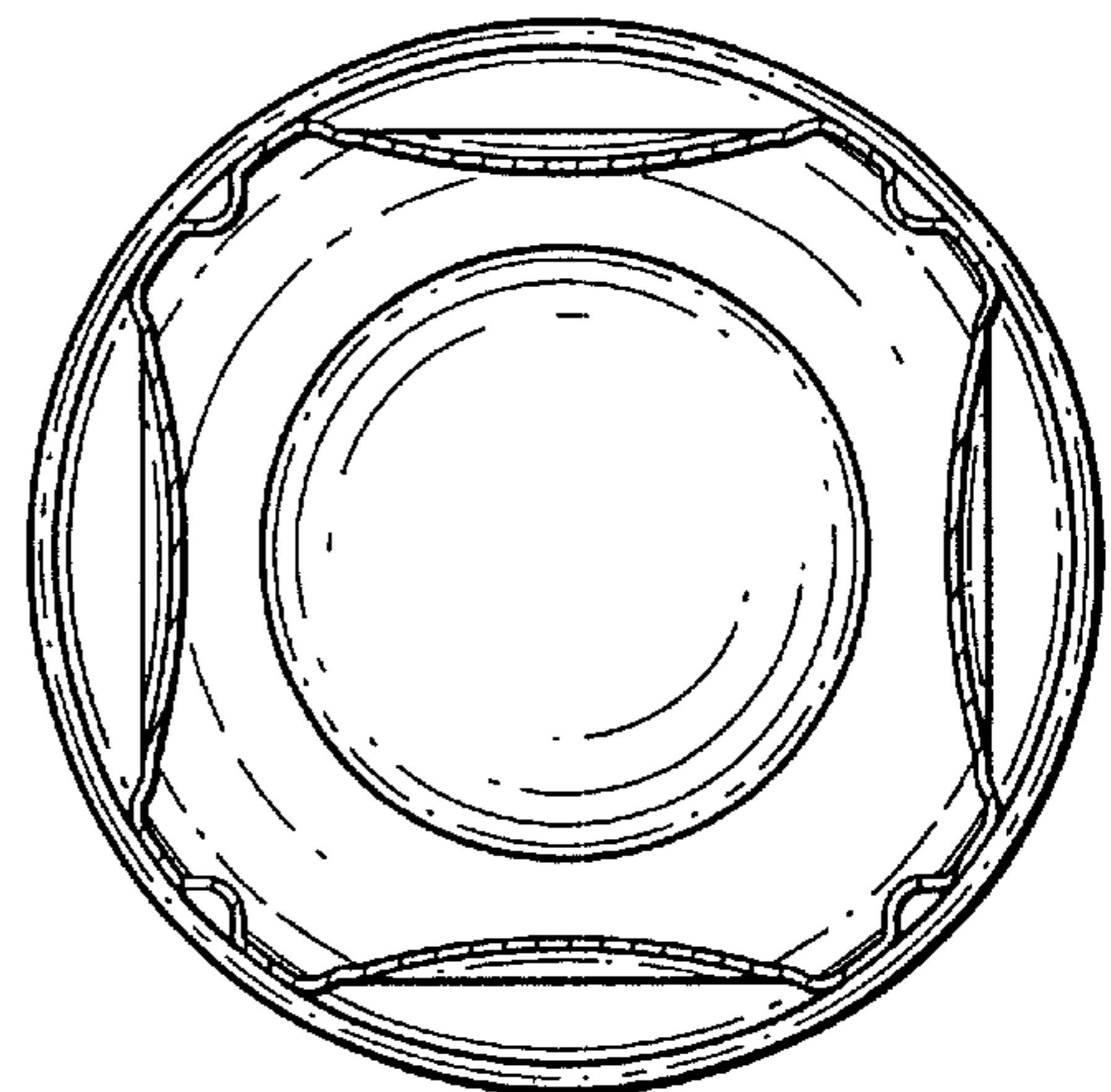

FIG. 5

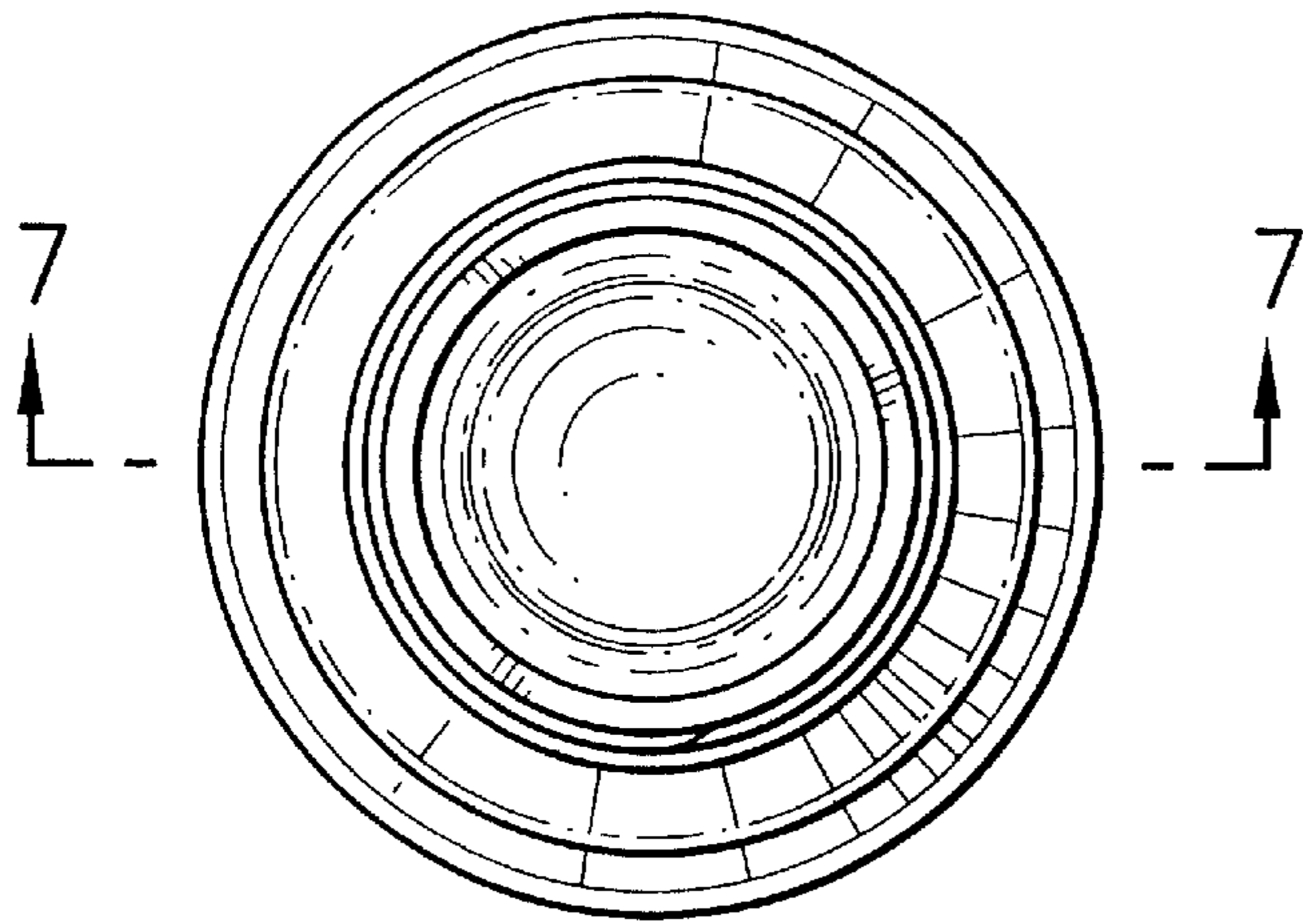

FIG. 6

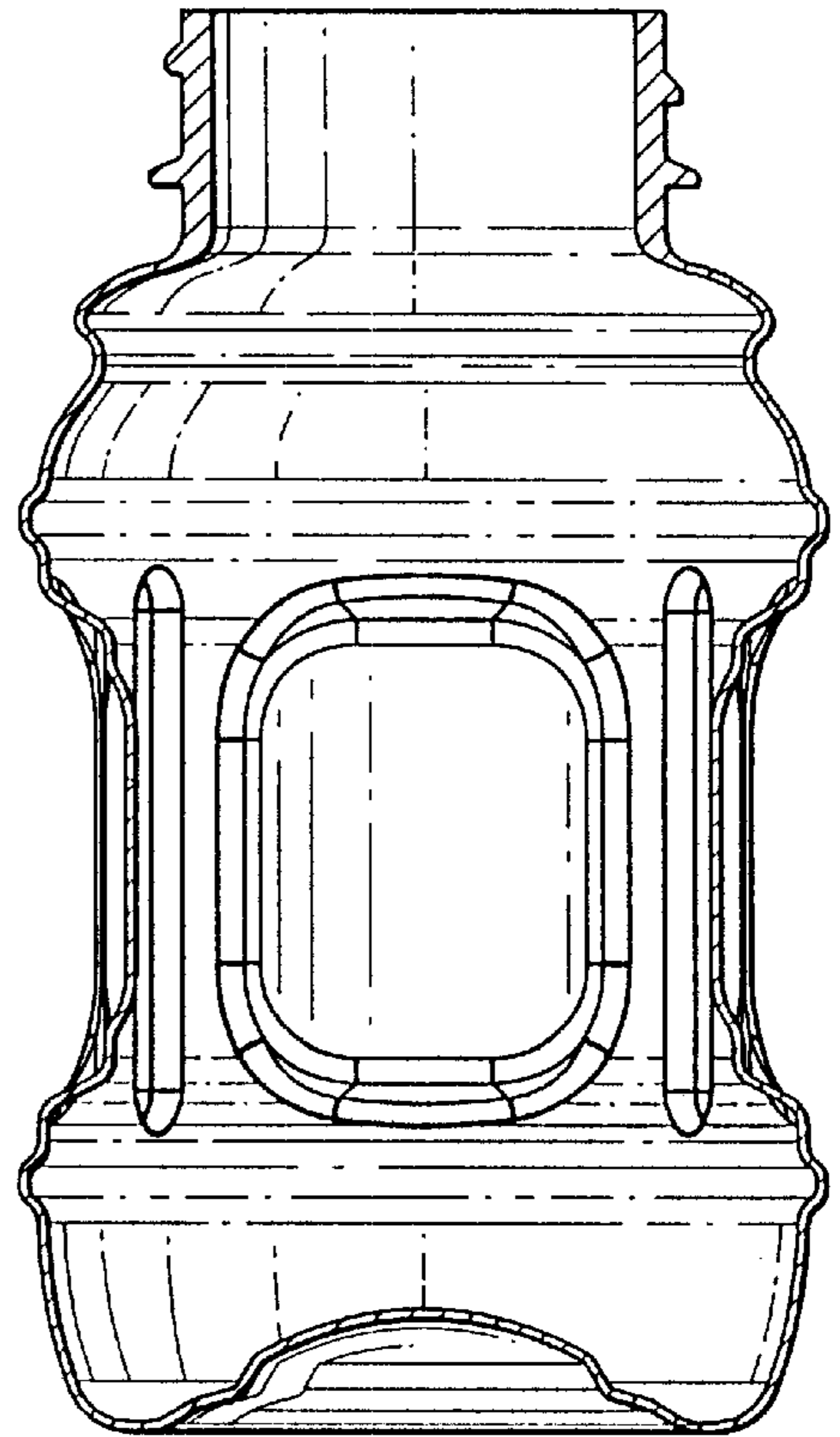

FIG. 7

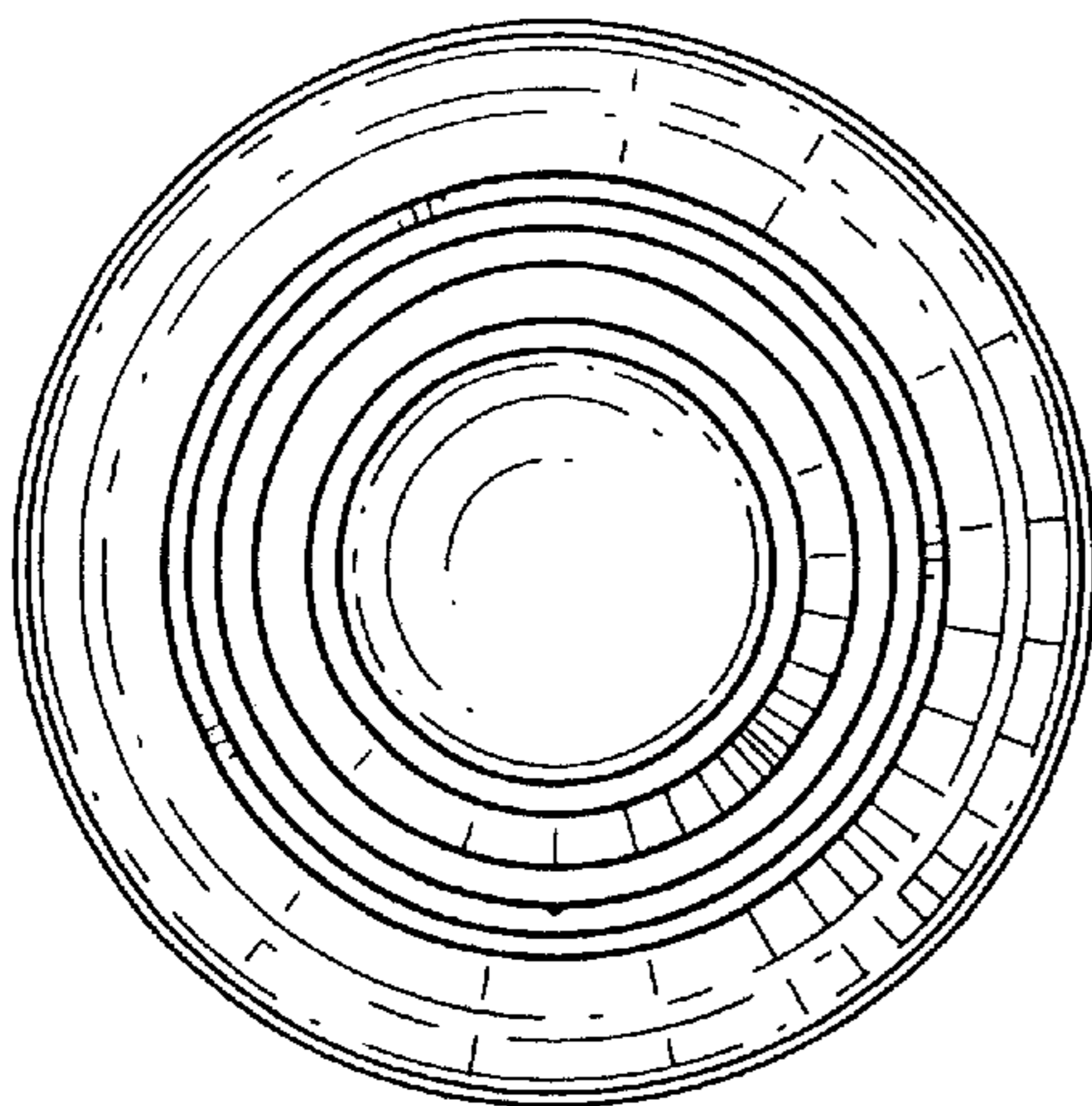

FIG. 8