



US00D480273S

(12) **United States Design Patent**  
**Cordwell**

(10) **Patent No.:** **US D480,273 S**

(45) **Date of Patent:** **\*\* Oct. 7, 2003**

(54) **CARTON COOLER**

**DESCRIPTION**

(76) Inventor: **Thomas Cordwell**, 632 Coolaroo Street, Tom Price, Western Australia (AU), 6751

(\*\*) Term: **14 Years**

(21) Appl. No.: **29/154,604**

(22) Filed: **Jan. 25, 2002**

(51) **LOC (7) Cl.** ..... **07-01**

(52) **U.S. Cl.** ..... **D7/605; D7/607; D7/624**

(58) **Field of Search** ..... **D7/605-608, 619-625; 215/12.1, 12.2, 13.1; 62/457.1-457.5, 530; 220/737, 739, 902, 903**

(56) **References Cited**

**U.S. PATENT DOCUMENTS**

4,344,303 A \* 8/1982 Kelly, Jr. .... 62/530  
5,697,707 A \* 12/1997 Esposito ..... D7/619 X

\* cited by examiner

*Primary Examiner*—Terry A. Wallace

(74) *Attorney, Agent, or Firm*—Reising, Ethington, Barnes, Kisselle, P.C.

(57) **CLAIM**

The ornamental design for a carton cooler, substantially as shown and described.

FIG. 1 is a top fragmented perspective view of a carton cooler showing my new design;

FIG. 2 is a bottom fragmented perspective view thereof;

FIG. 3 is a top fragmented perspective view thereof;

FIG. 4 is a top plan view thereof;

FIG. 5 is a top plan view thereof when the carton is in position therein;

FIG. 6 is a bottom plan view thereof;

FIG. 7 is a side fragmented elevational view thereof;

FIG. 8 is a top fragmented perspective view of a modified form of my new design;

FIG. 9 is a bottom fragmented perspective view thereof;

FIG. 10 is a top fragmented perspective view thereof;

FIG. 11 is a top fragmented plan view thereof;

FIG. 12 is a top fragmented plan view thereof when a carton is in position therein;

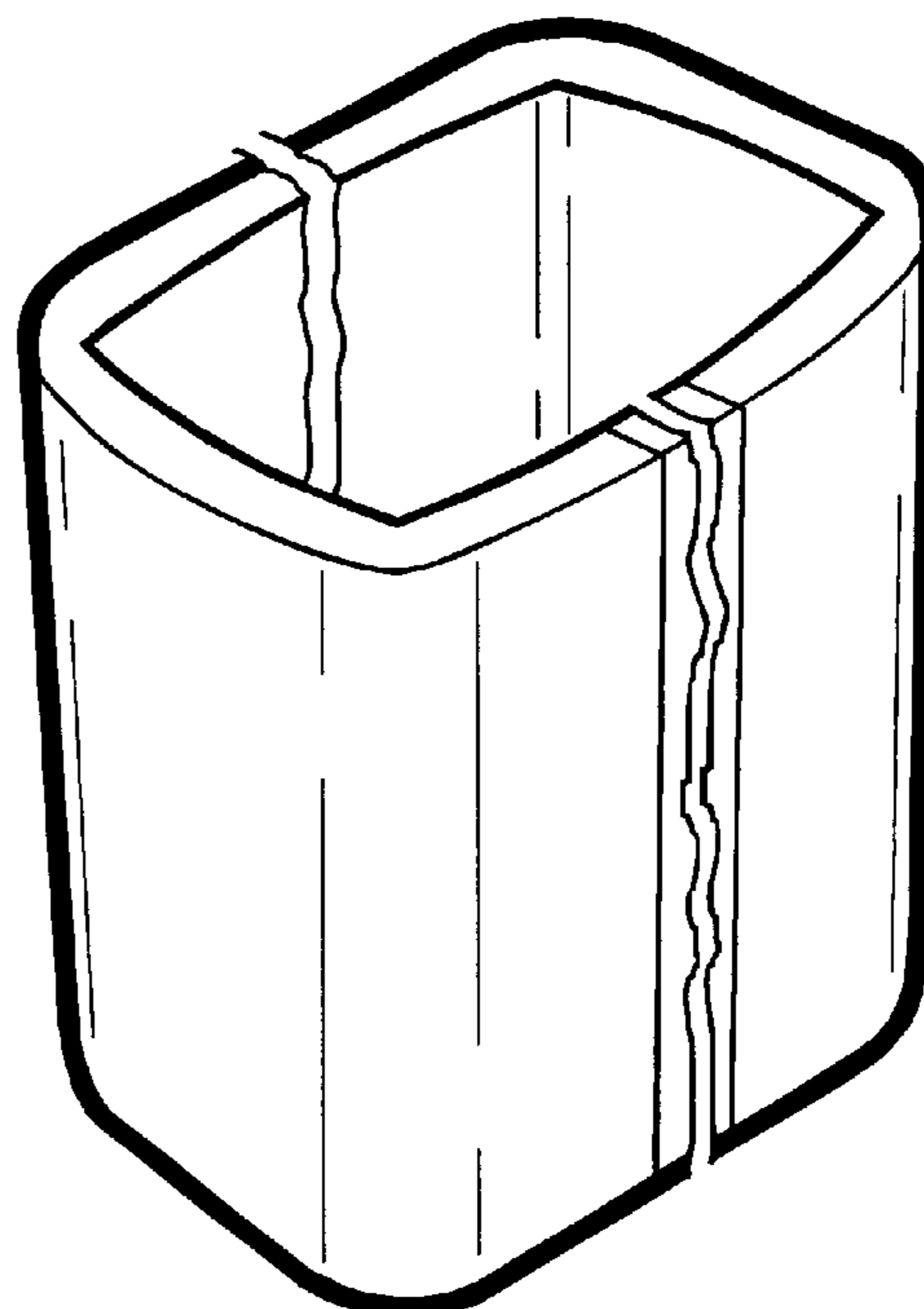
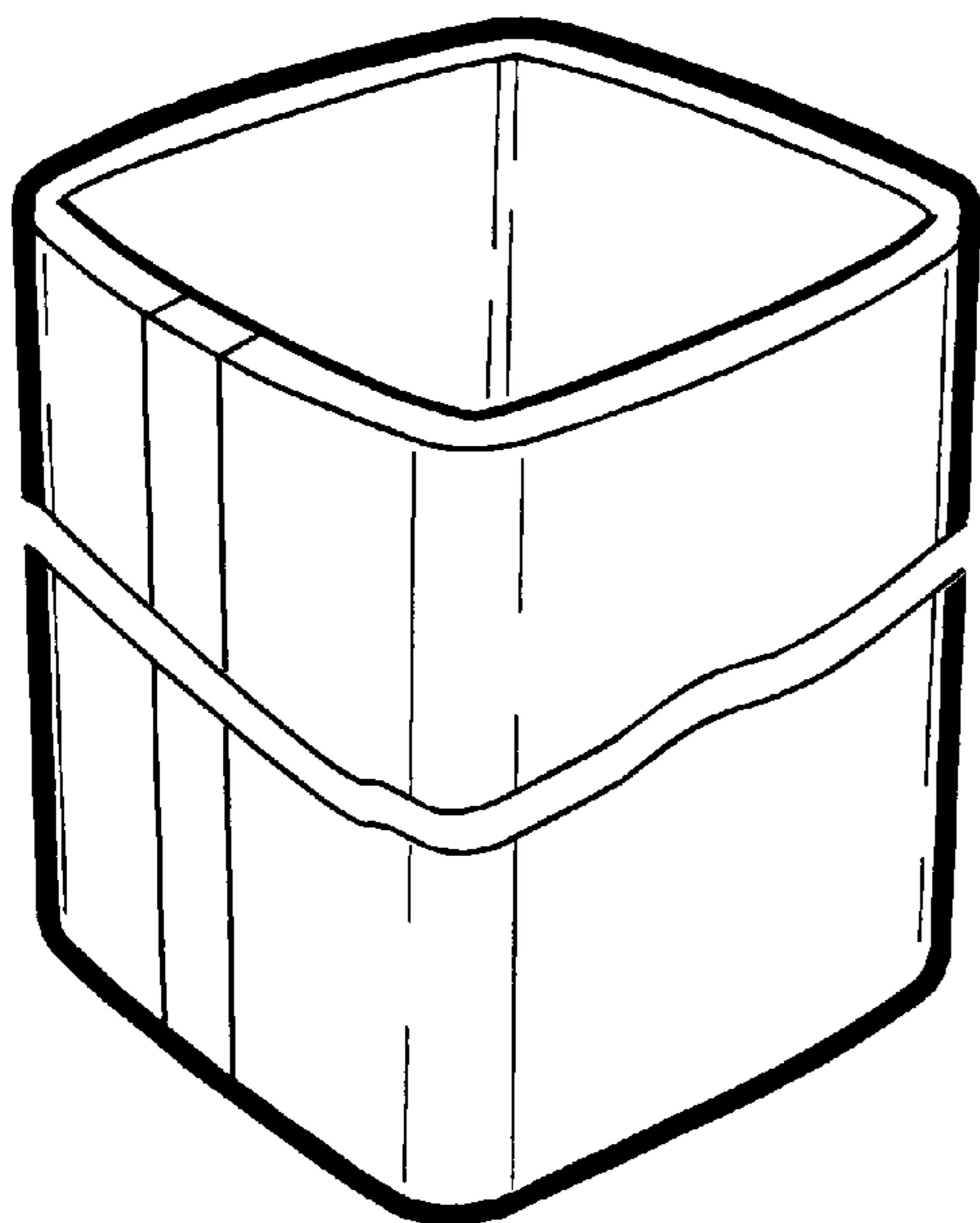
FIG. 13 is a bottom fragmented plan view thereof;

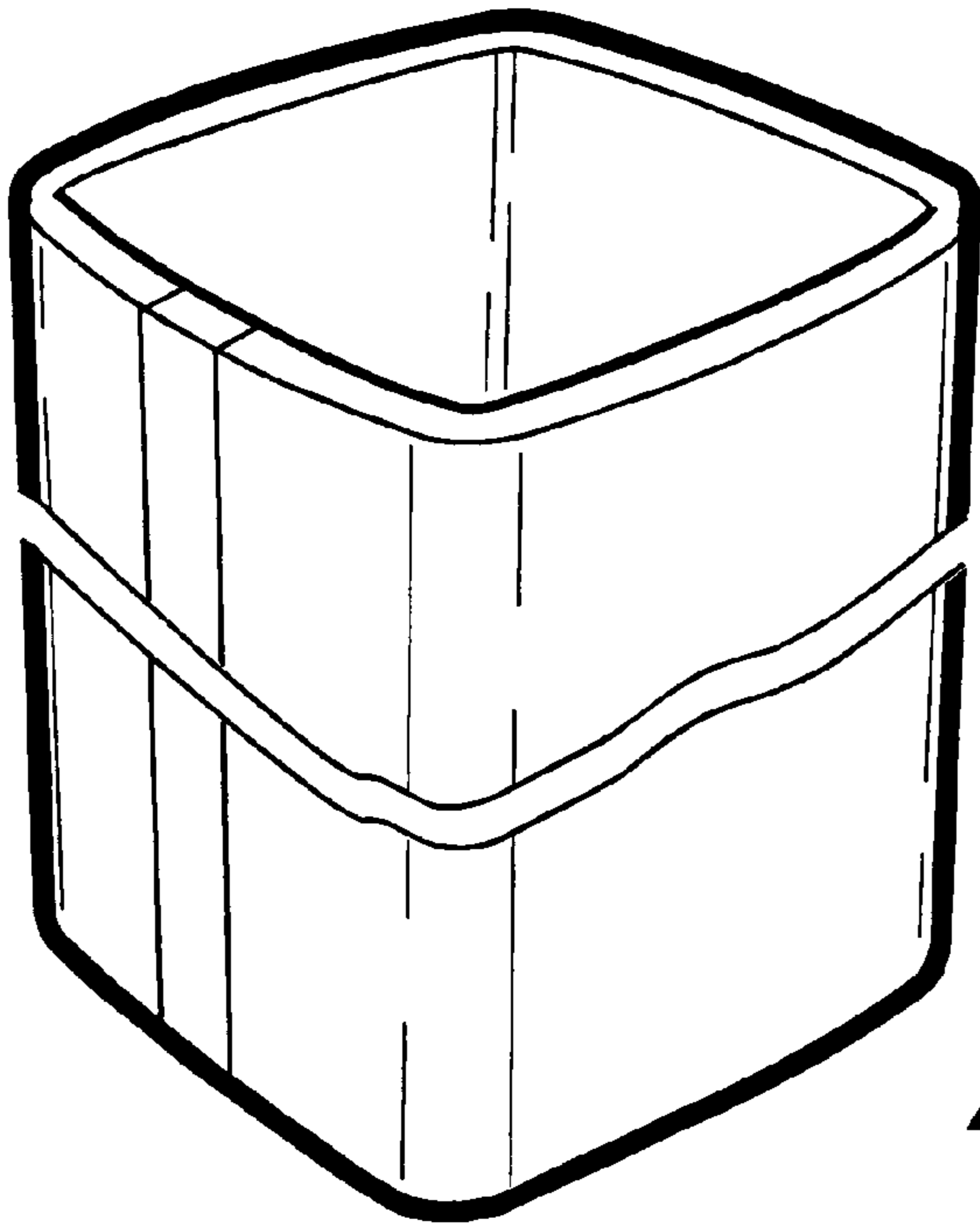
FIG. 14 is a side fragmented elevational view thereof; and,

FIG. 15 is a front elevational view thereof.

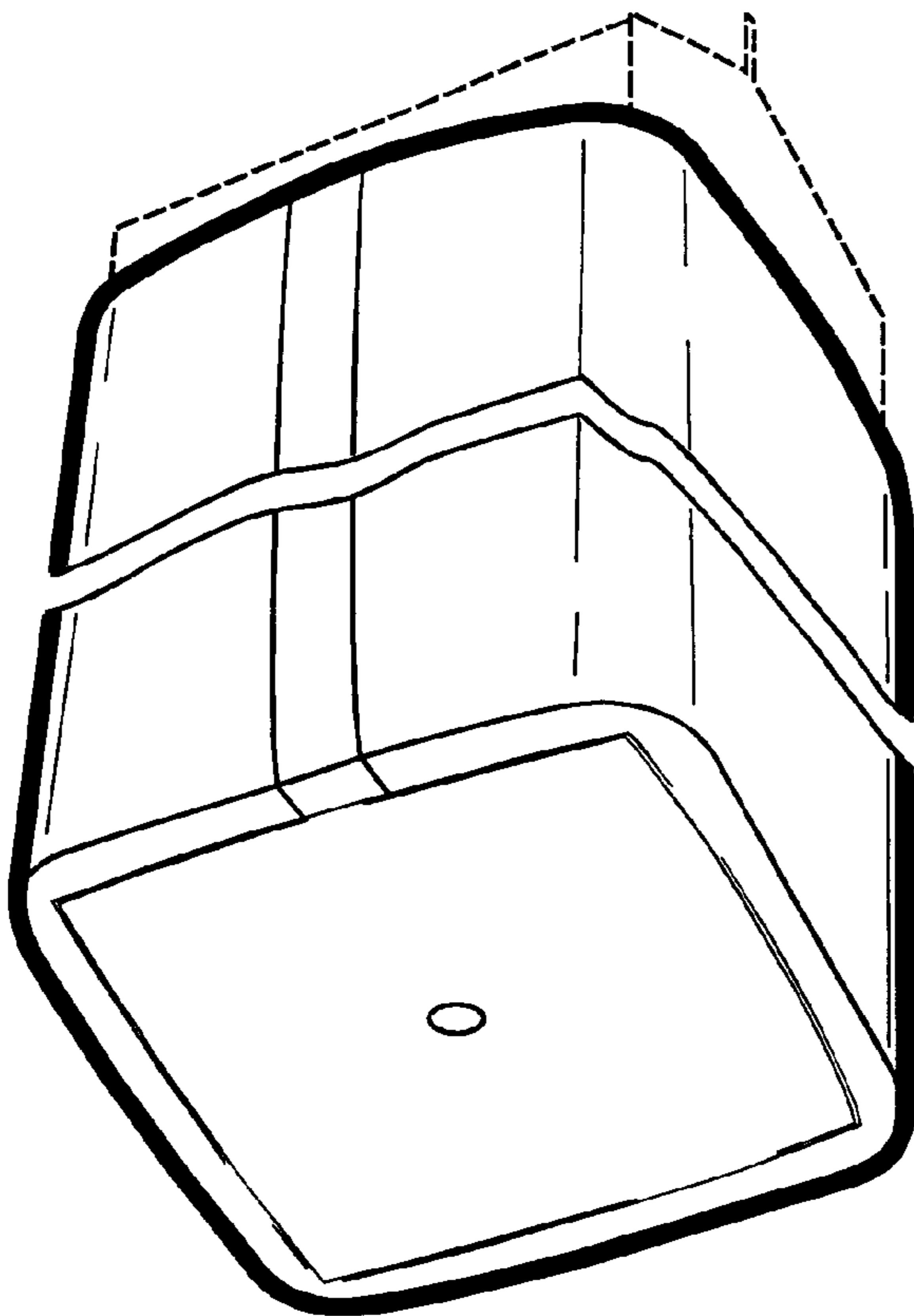
The broken lines showing a carton in FIGS. 2 and 7 are for the purposes of illustration only and form no part of the claimed design.

**1 Claim, 8 Drawing Sheets**

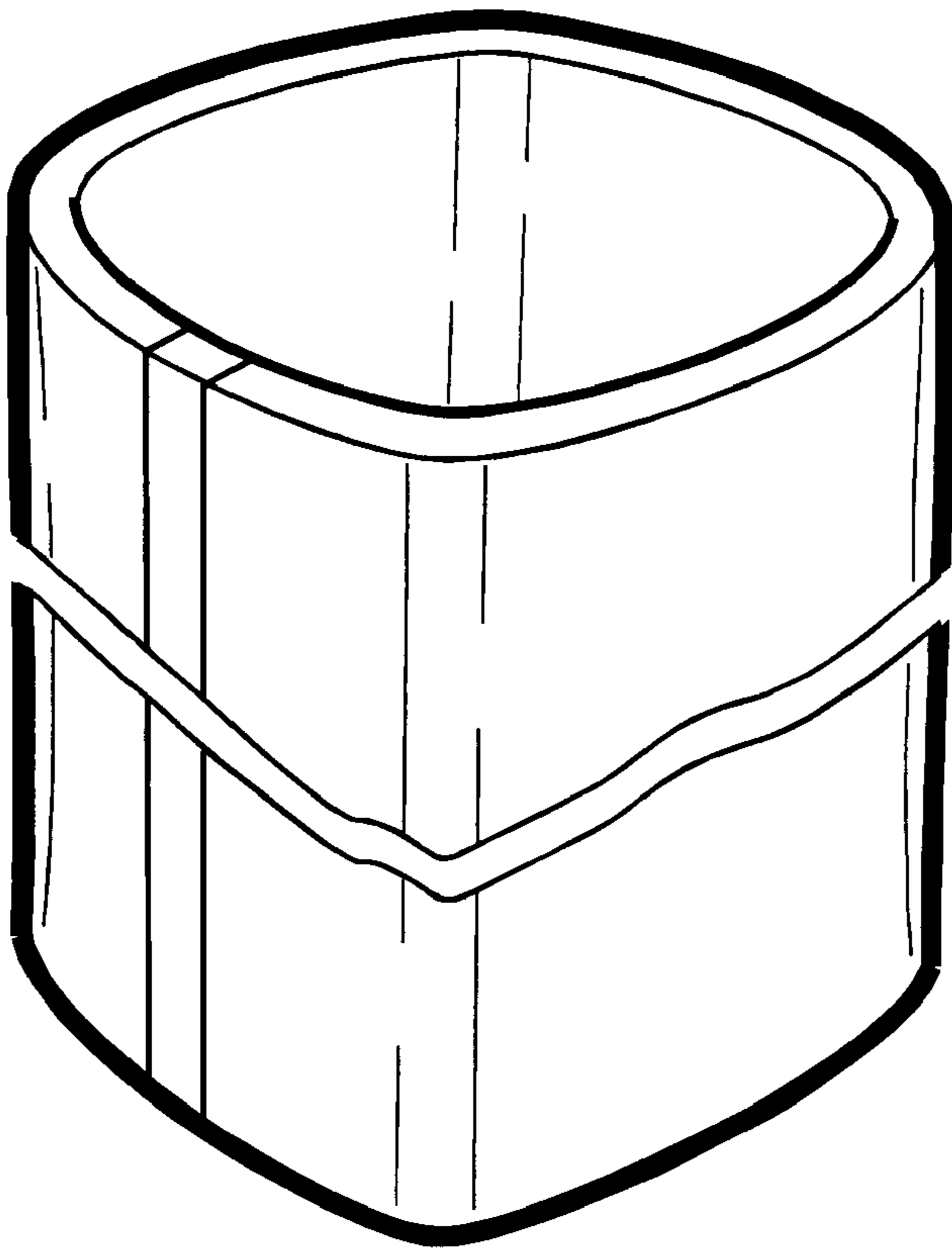




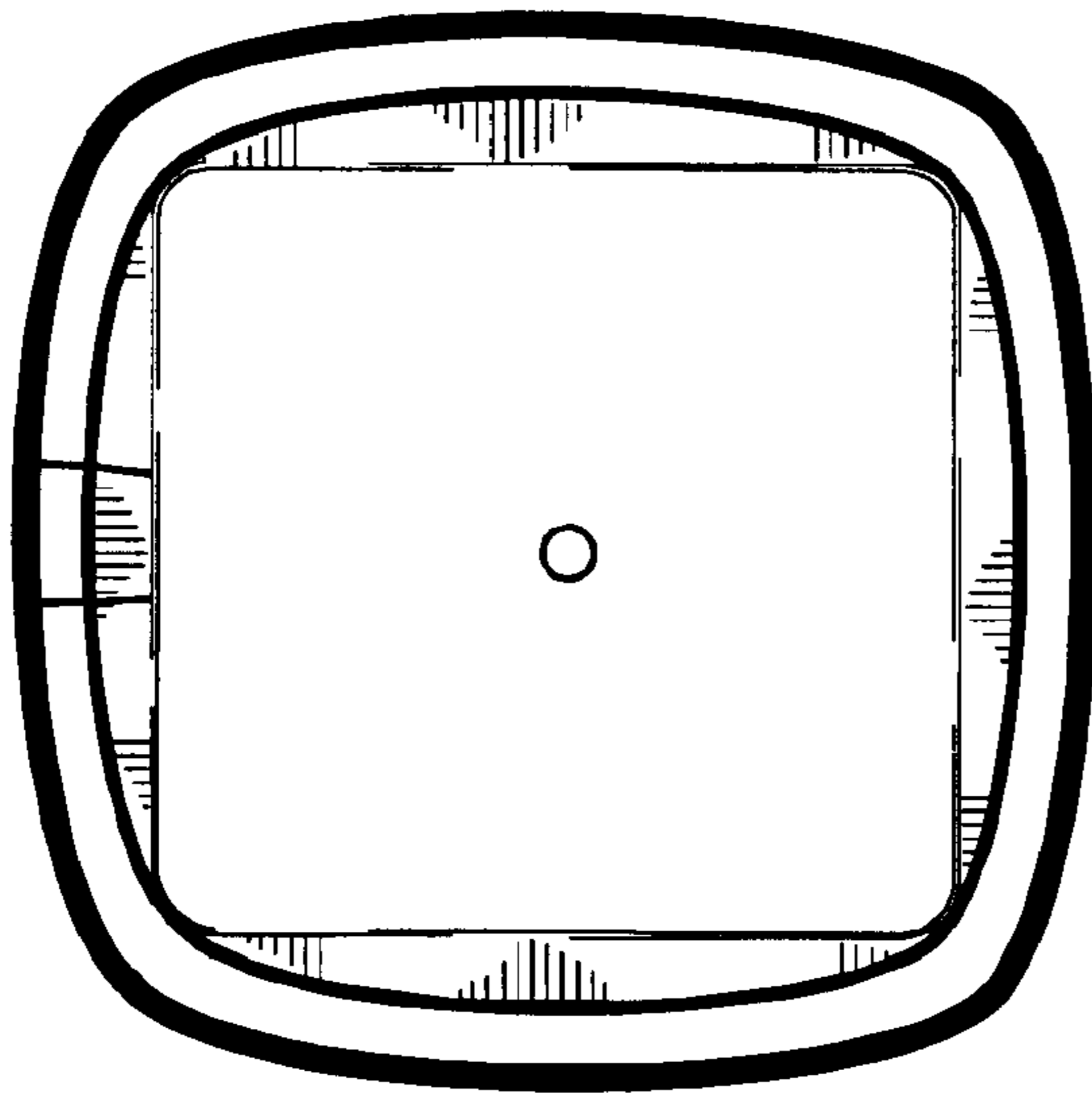
**Fig. 1.**



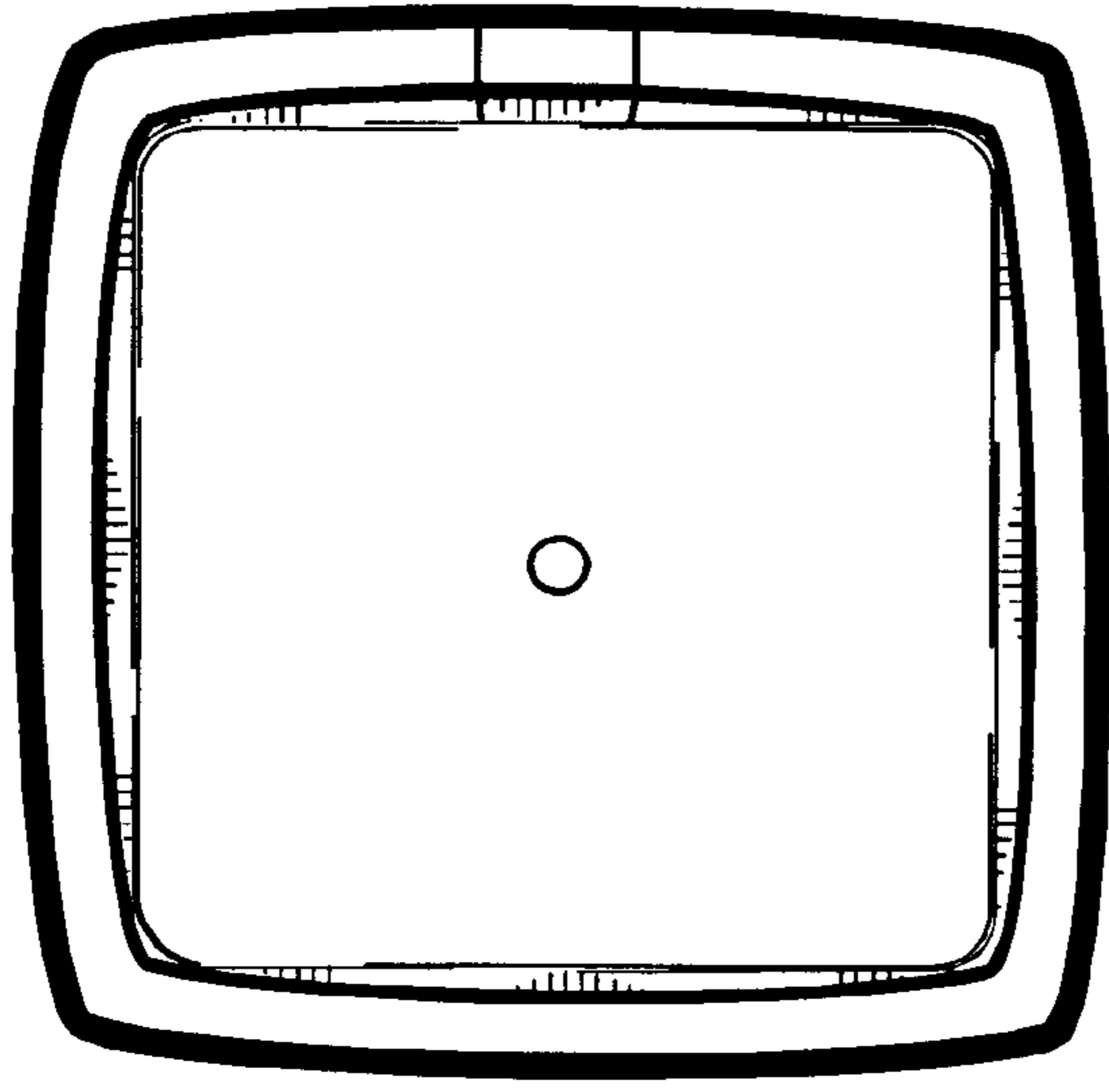
**Fig. 2.**



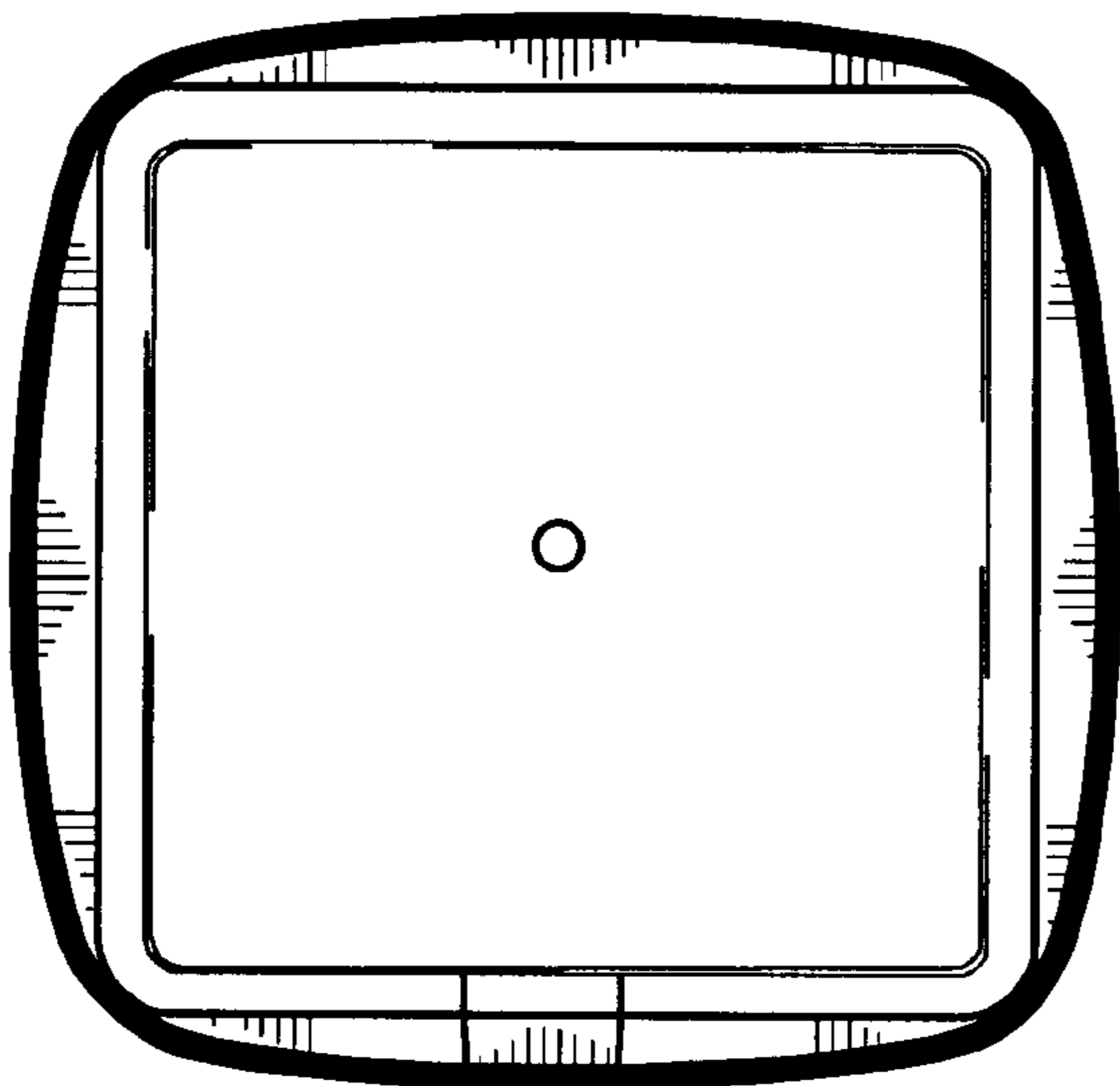
**Fig. 3,**



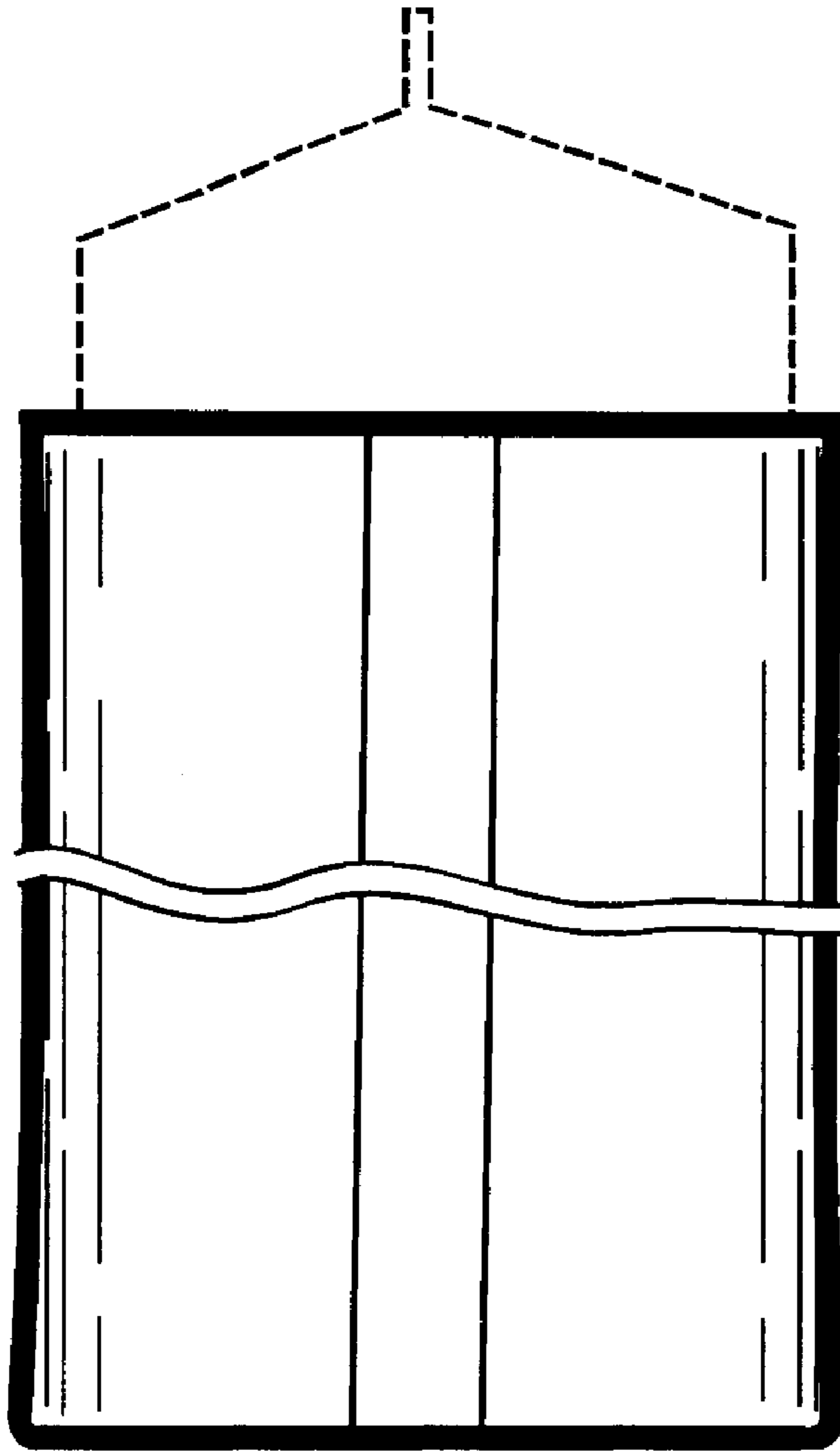
**Fig. 4,**



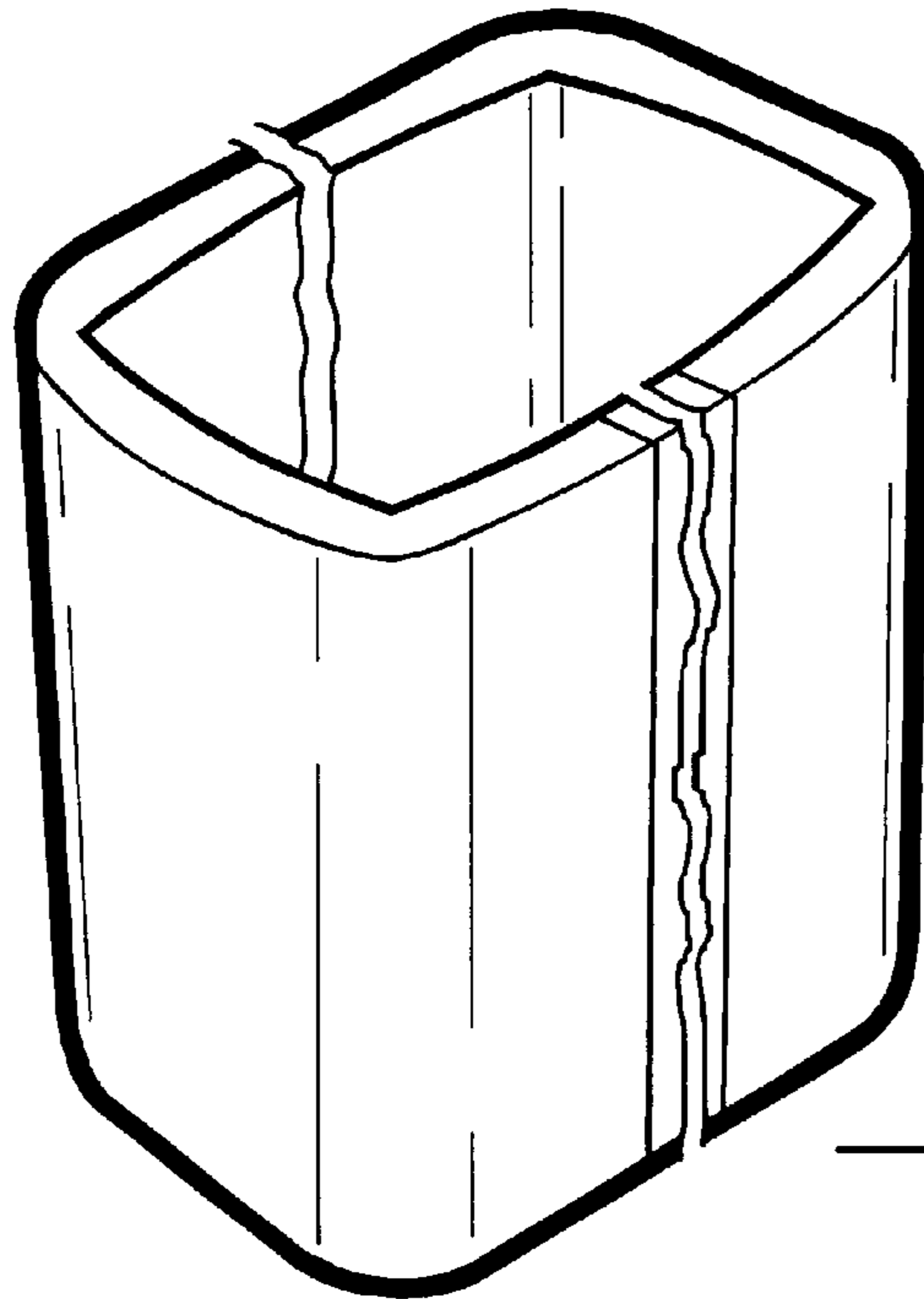
**Fig. 5.**



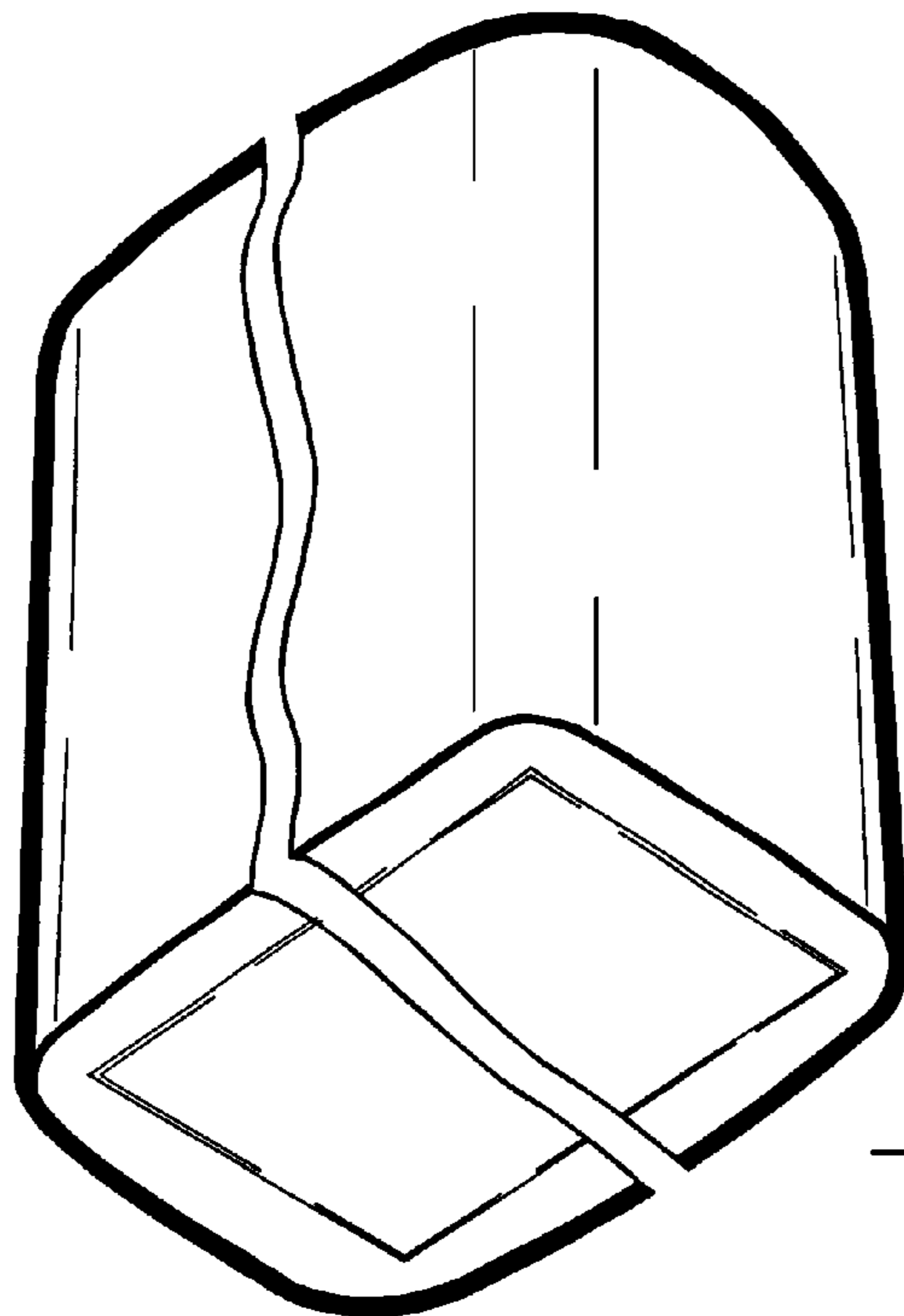
**Fig. 6.**



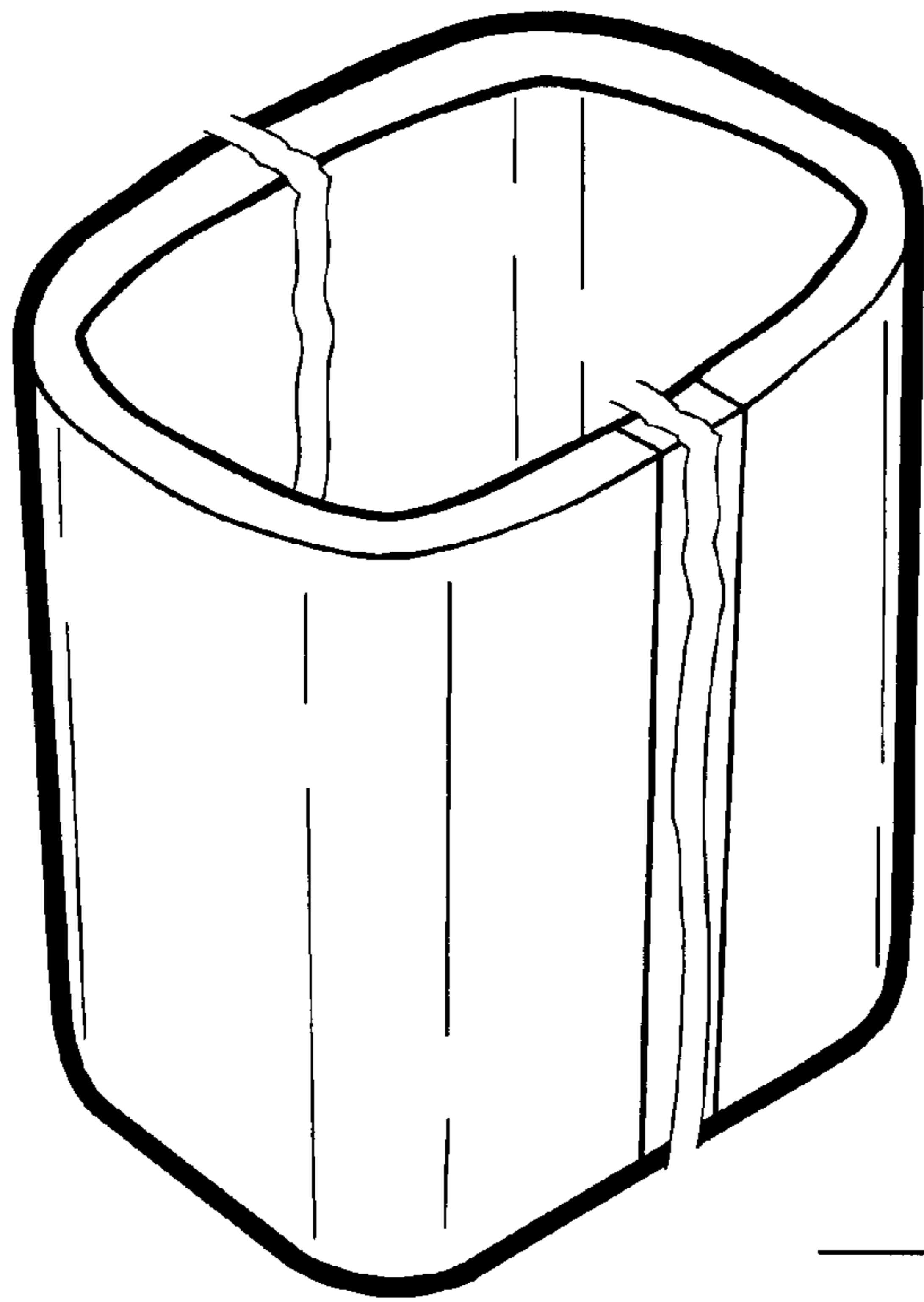
**Fig. 7.**



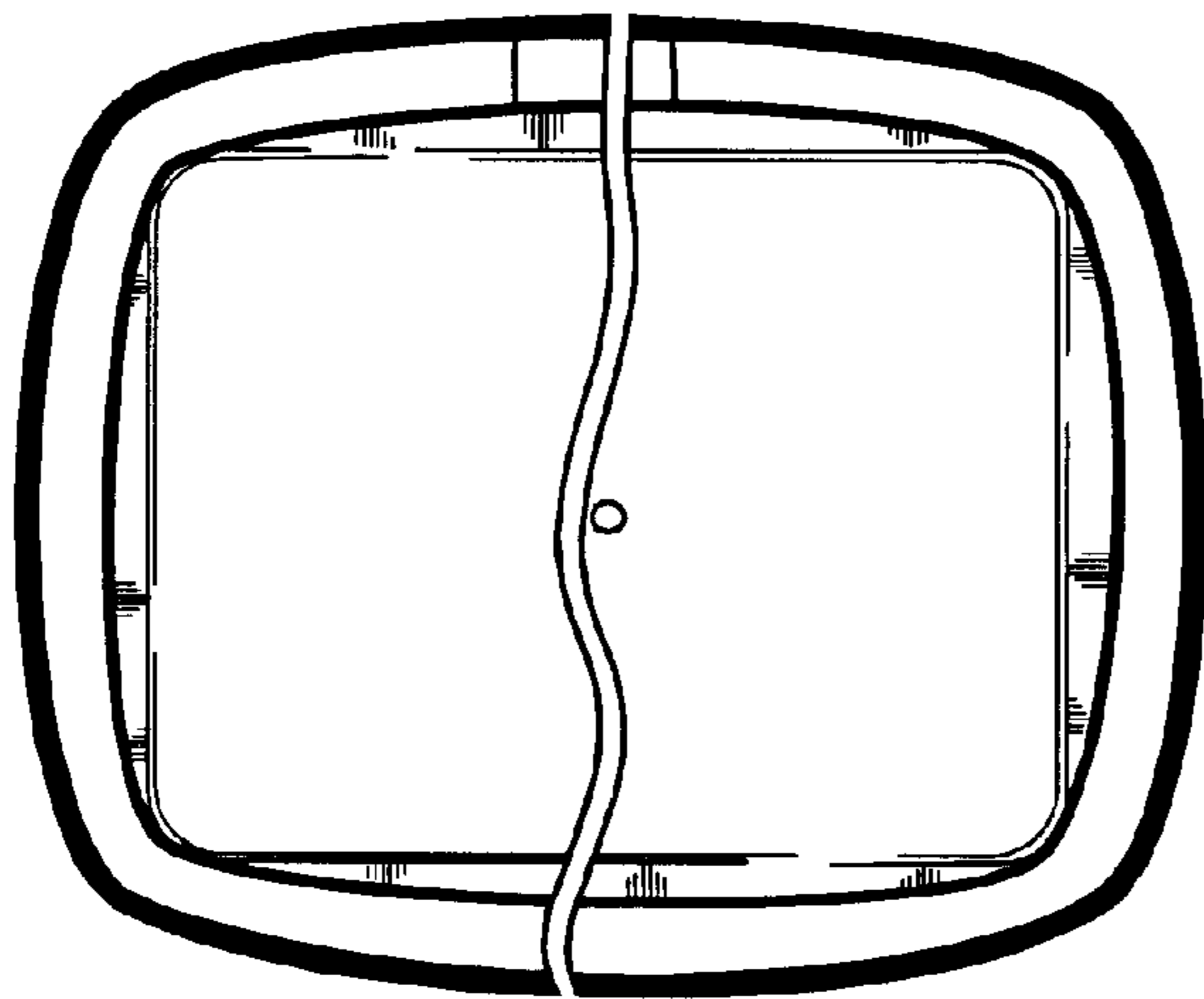
**Fig. 8.**



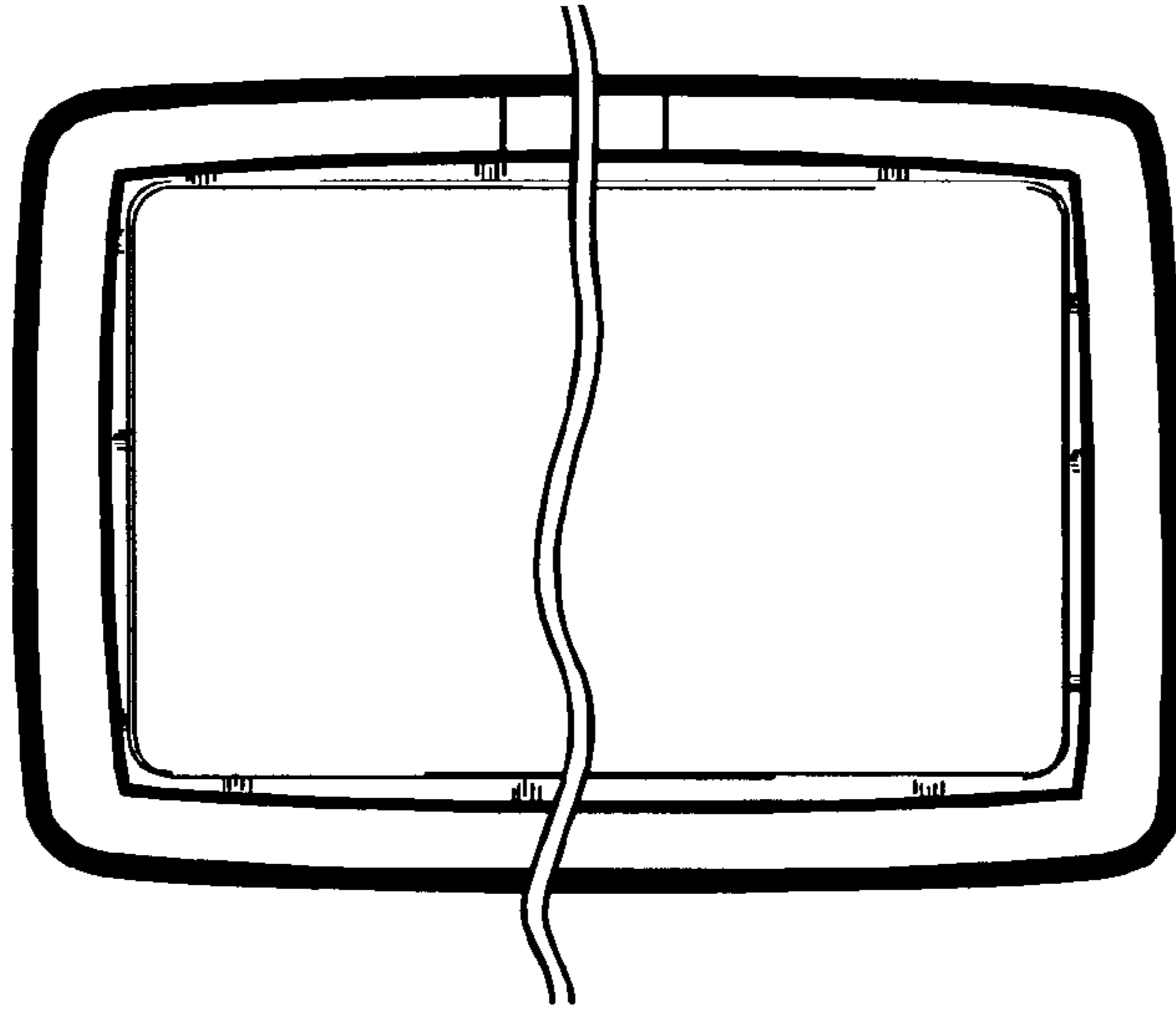
**Fig. 9.**



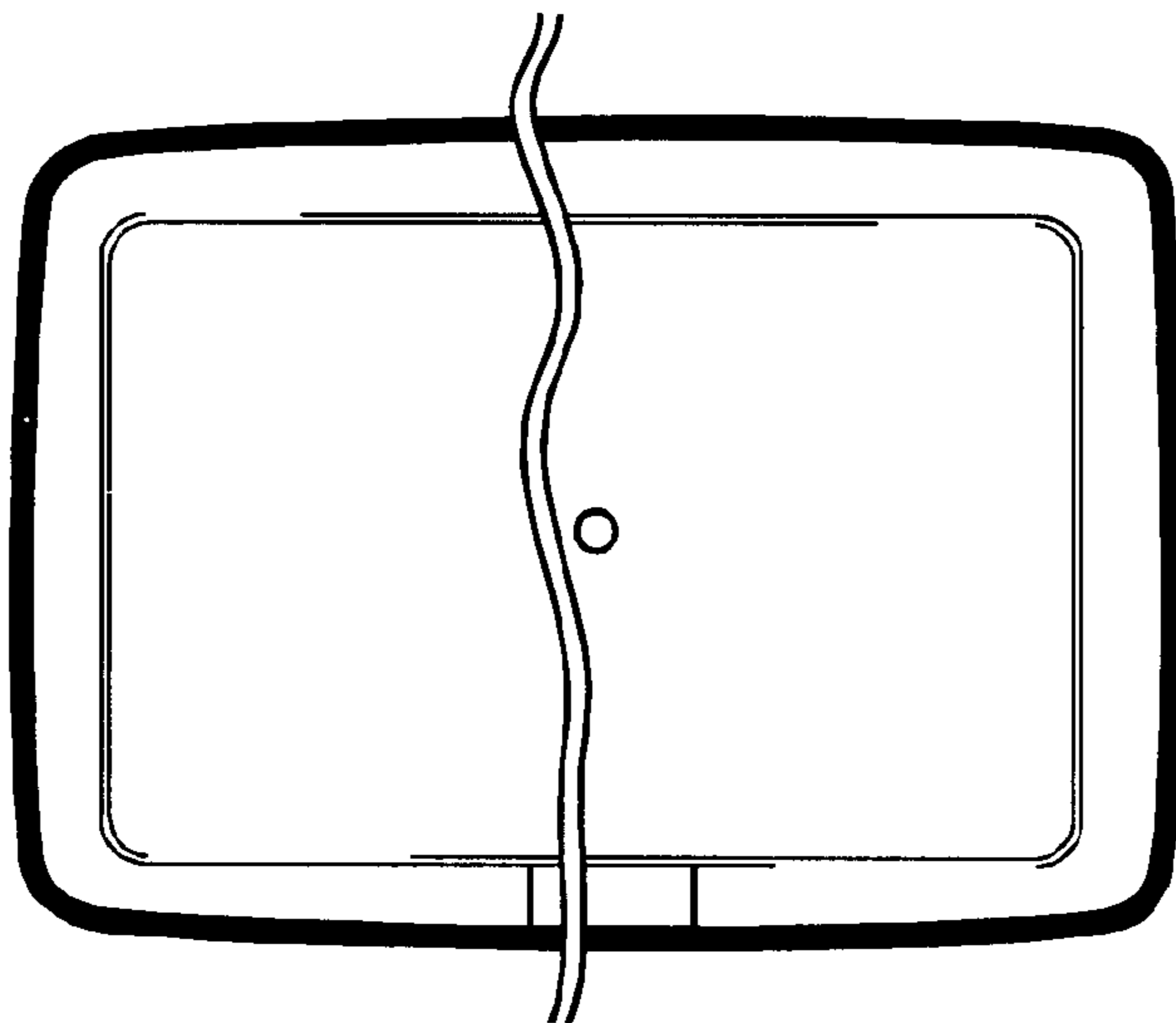
**Fig. 10,**



**Fig. 11,**

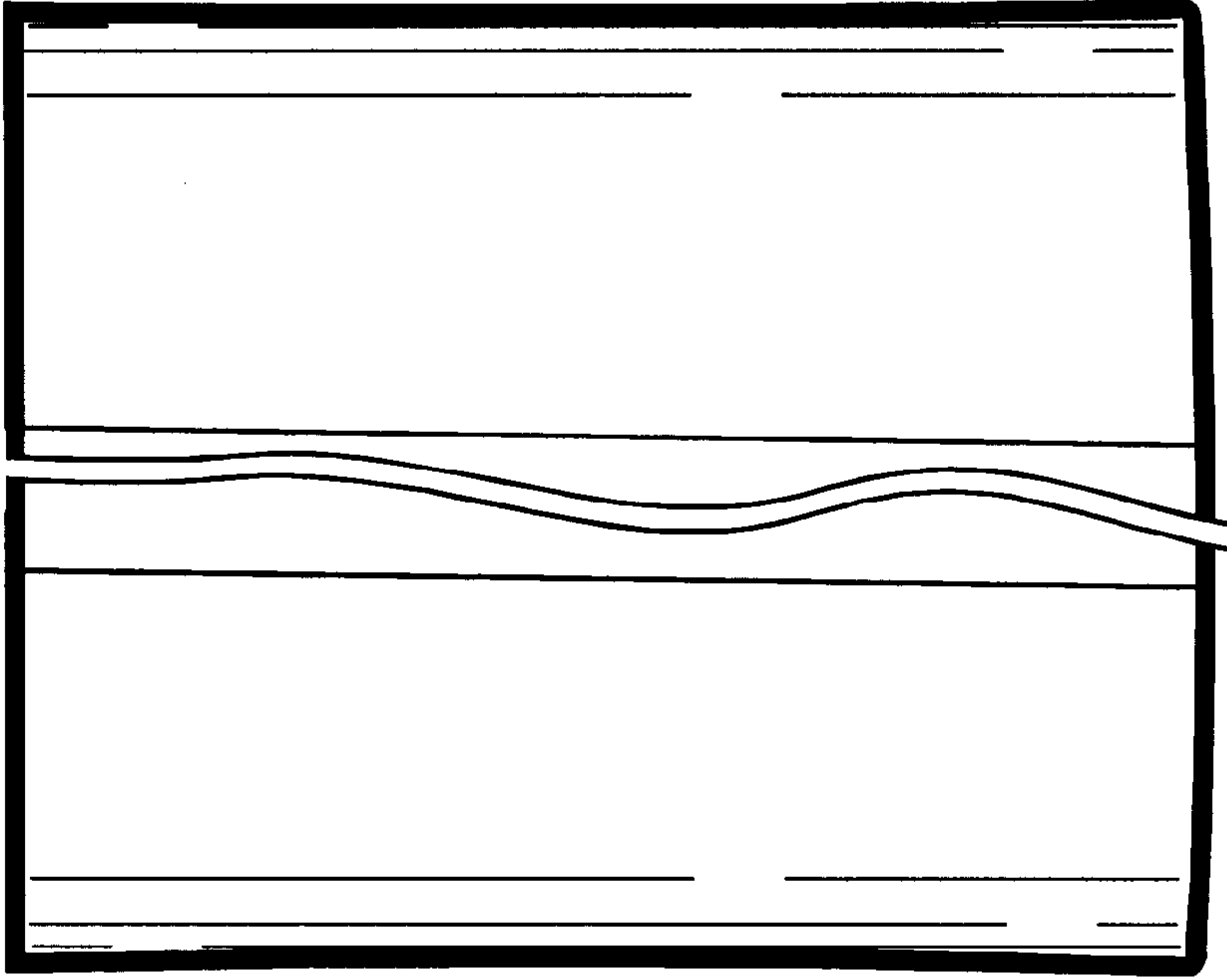


**Fig. 12.**

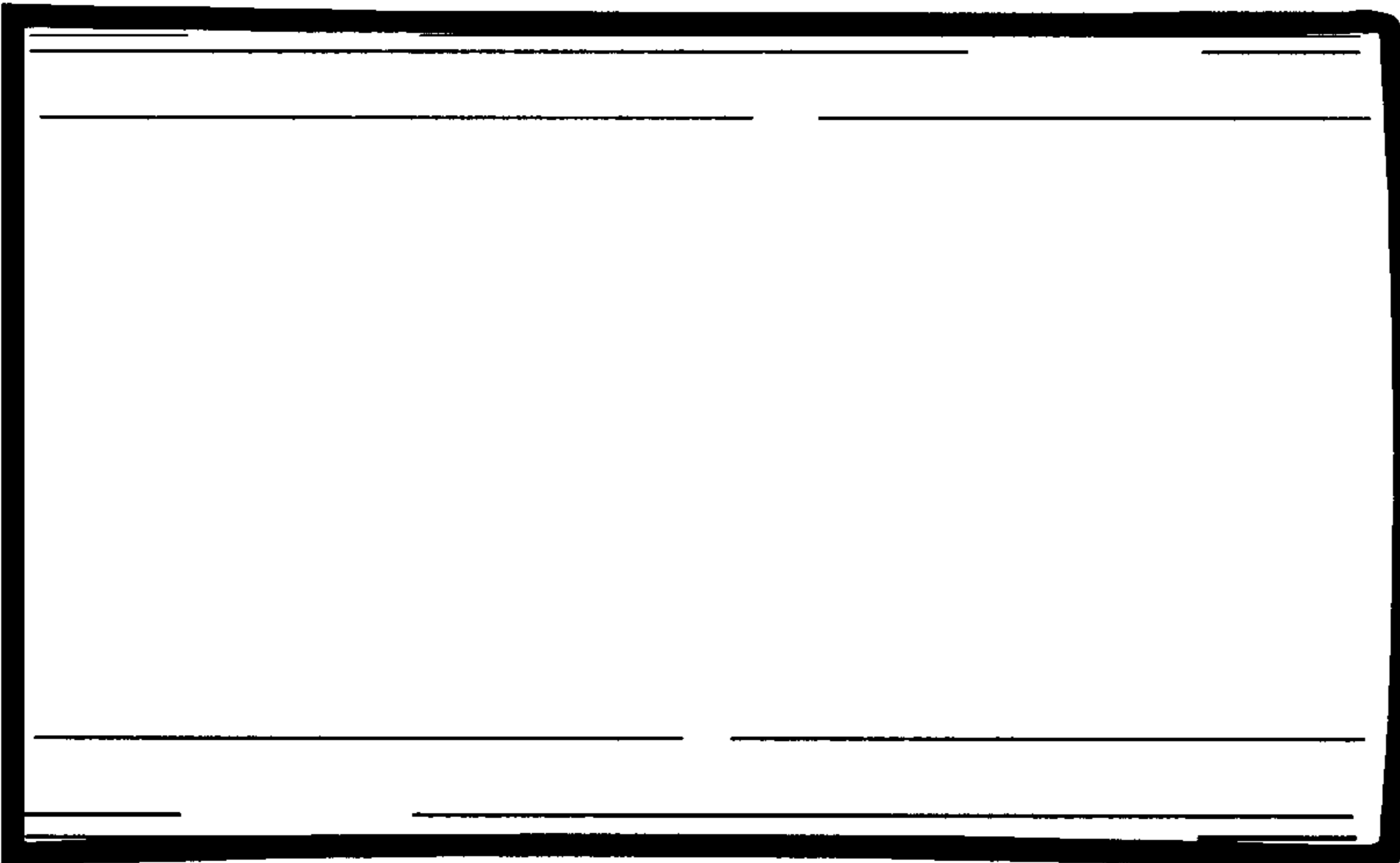


**Fig. 13.**





**FIG. 14,**



**FIG. 15,**