



US00D480210S

(12) **United States Design Patent**  
**Wolf**

(10) **Patent No.:** **US D480,210 S**

(45) **Date of Patent:** **\*\* Oct. 7, 2003**

(54) **JEWELRY TRAVEL CASE**

(75) Inventor: **Simon Wolf**, Malibu, CA (US)

(73) Assignee: **Wolf Designs, Inc.**, Malibu, CA (US)

(\*\*) Term: **14 Years**

(21) Appl. No.: **29/176,378**

(22) Filed: **Feb. 20, 2003**

(51) **LOC (7) Cl.** ..... **03-01**

(52) **U.S. Cl.** ..... **D3/294; D3/294; D3/903**

(58) **Field of Search** ..... **D3/273, 274, 275,**  
**D3/283, 284, 294, 295, 246, 901, 903;**  
**206/6.1, 566; D9/423, 424; 190/109, 110,**  
**111**

(56) **References Cited**

**U.S. PATENT DOCUMENTS**

D325,123 S	*	4/1992	Tirmani	.....	D3/275
D351,283 S	*	10/1994	Wolff	.....	D3/281
5,692,605 A	*	12/1997	Lai	.....	206/6.1
D416,135 S	*	11/1999	Chen	.....	D3/276
D417,783 S	*	12/1999	Wolf	.....	D3/297
D418,298 S	*	1/2000	Wolf	.....	D3/297
D451,671 S	*	12/2001	Wolf	.....	D3/275
D454,687 S	*	3/2002	Wolf	.....	D3/275
D455,550 S	*	4/2002	Wolf	.....	D3/275

D455,902 S	*	4/2002	Wolf	.....	D3/275
D457,315 S	*	5/2002	Wolf	.....	D3/290
D467,427 S	*	12/2002	Wolf	.....	D3/289
D471,010 S	*	3/2003	Wolf	.....	D3/294

\* cited by examiner

*Primary Examiner*—Philip S. Hyder

(74) *Attorney, Agent, or Firm*—Cislo & Thomas, LLP

(57) **CLAIM**

The ornamental design for a jewelry travel case, as shown and described herein.

**DESCRIPTION**

FIG. 1. Is a perspective view of my jewelry travel case shown in the open position with the dotted lines showing being for illustrative purposes only for which no claim is made;

FIG. 2. Is a perspective view of my jewelry travel case as shown in the closed position relative to FIG. 1;

FIG. 3. Is a top view thereof;

FIG. 4. Is a bottom view thereof;

FIG. 5. Is a front view thereof;

FIG. 6. Is a rear view thereof; and,

FIG. 7. Is a right side elevational view thereof with the left side being a mirror image thereof.

**1 Claim, 4 Drawing Sheets**

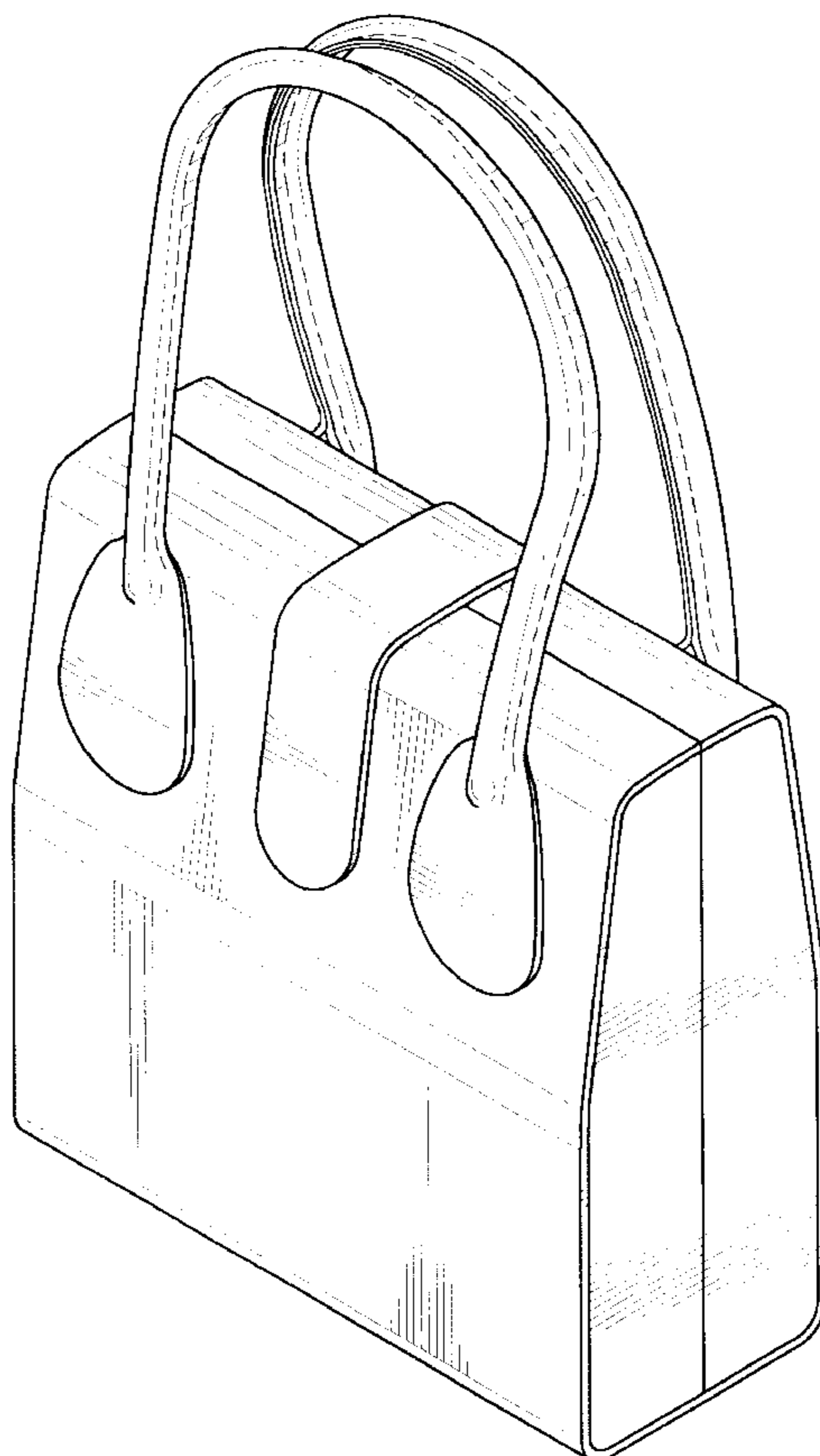

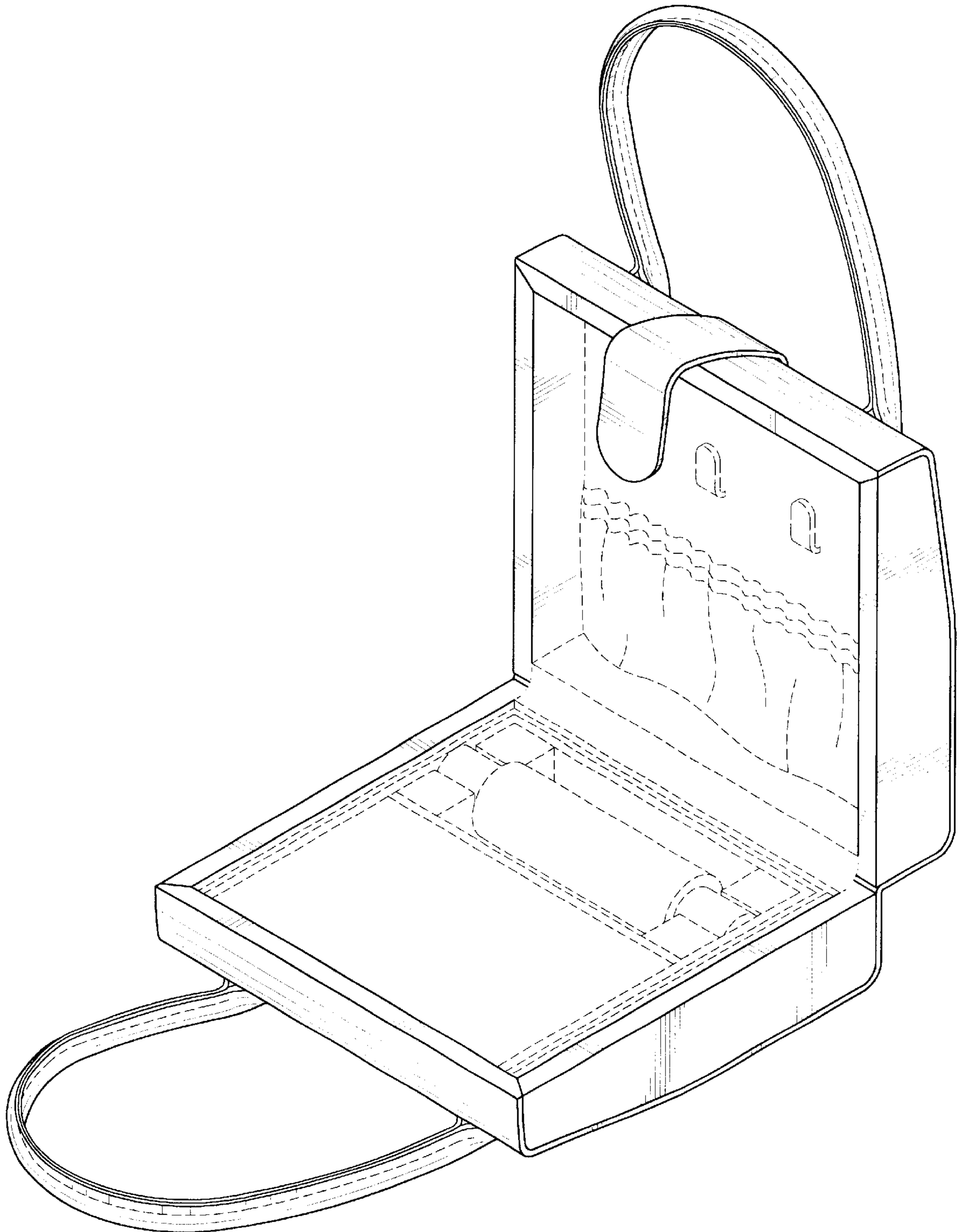

FIG. 1

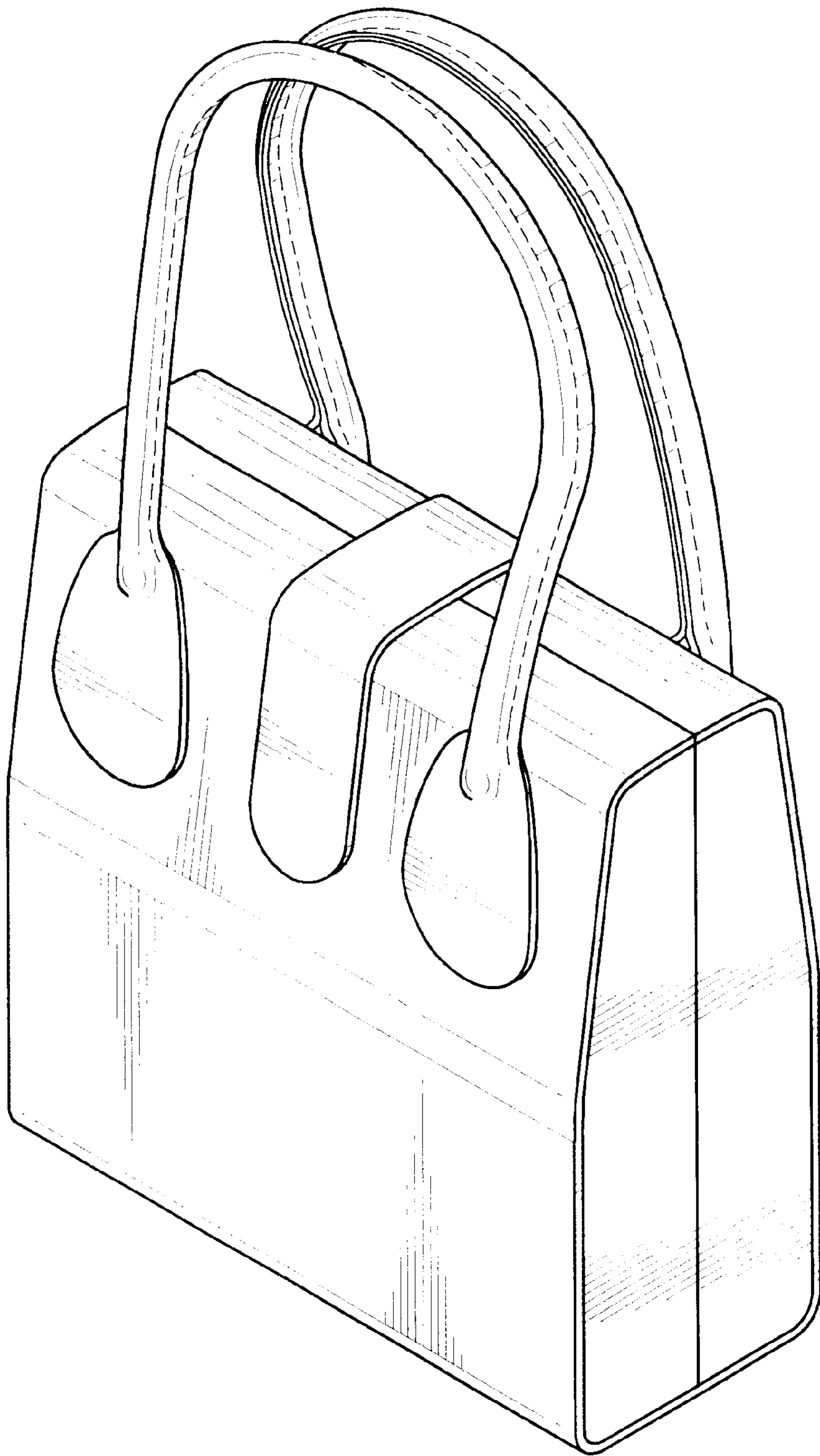

FIG. 2

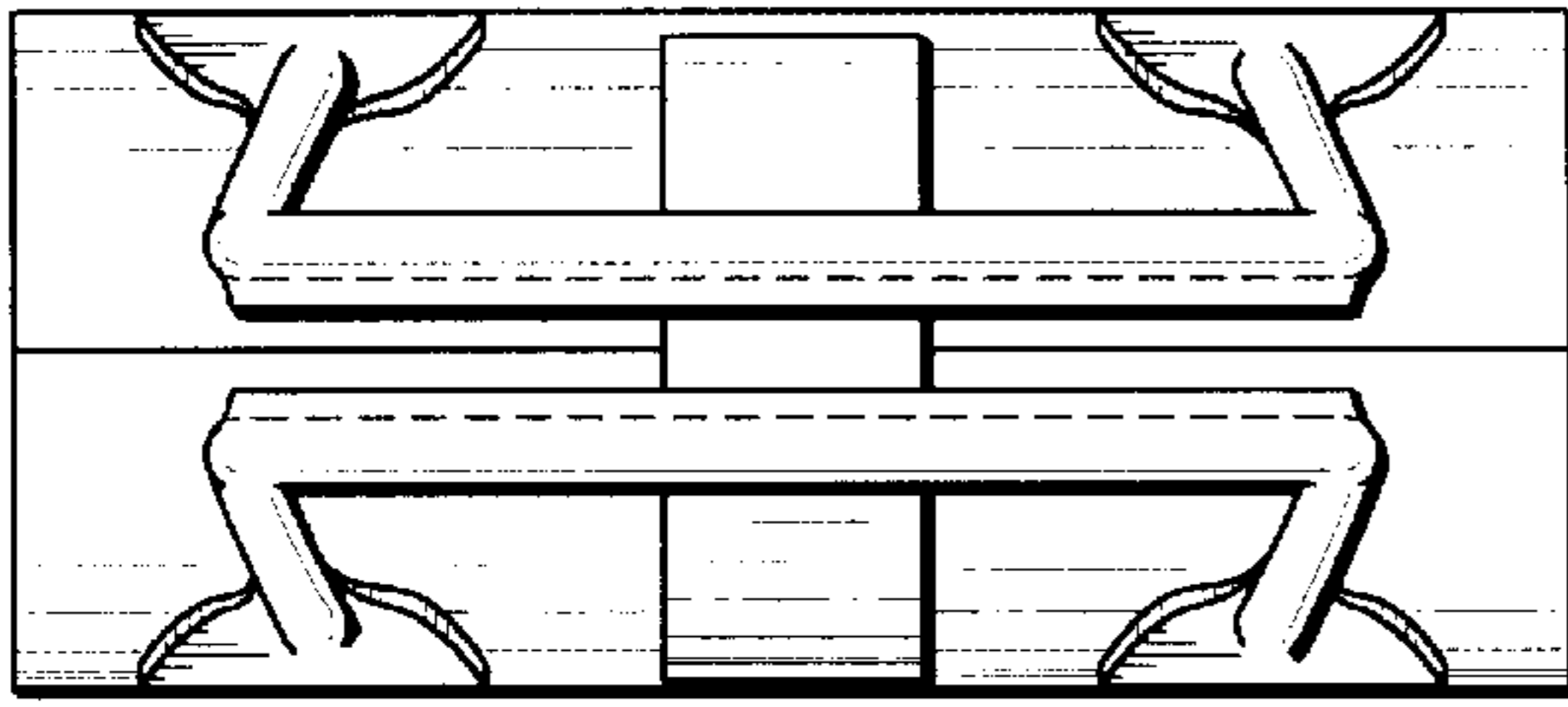

FIG. 3

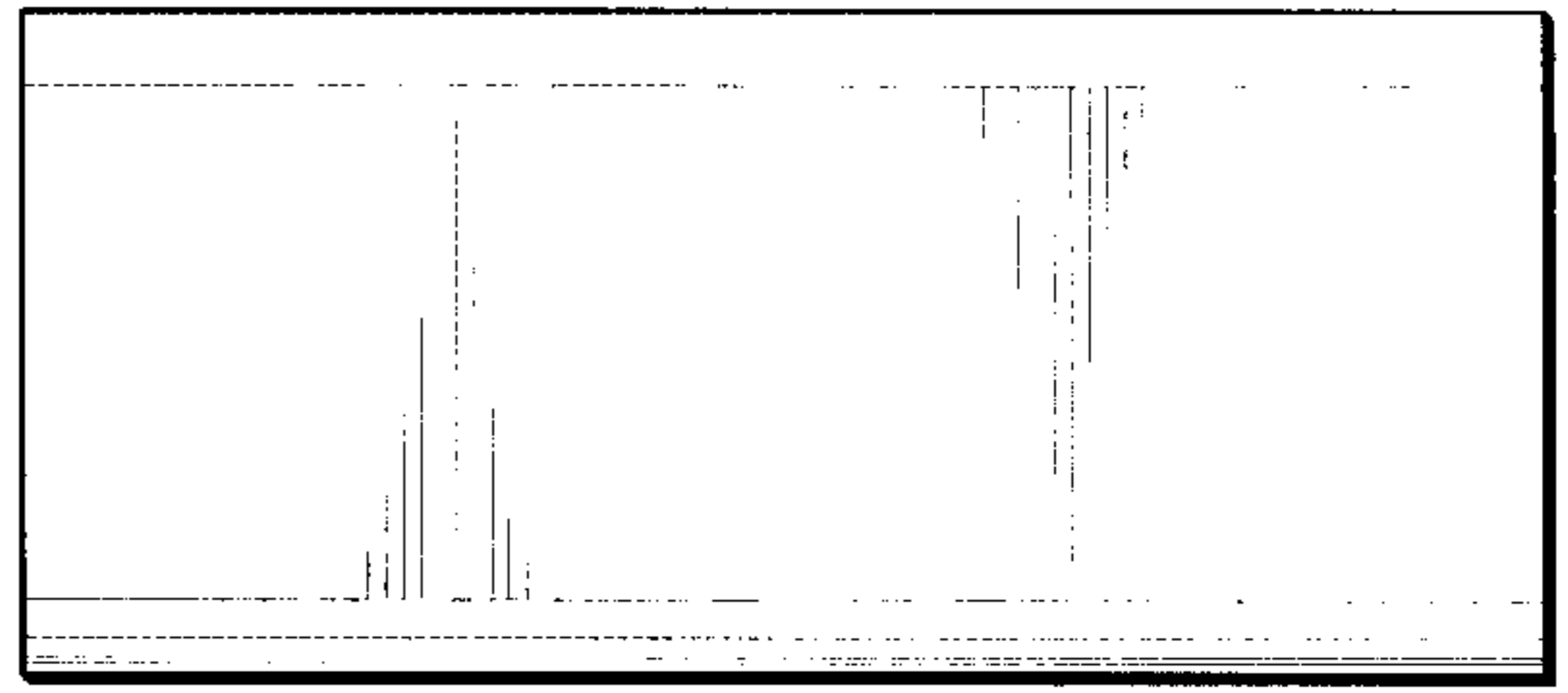

FIG. 4

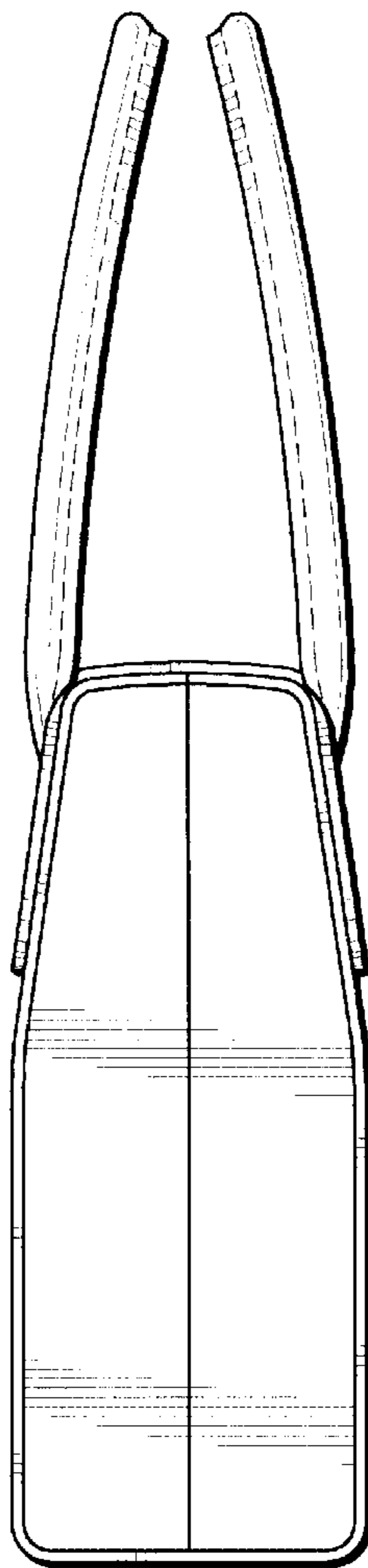

FIG. 7

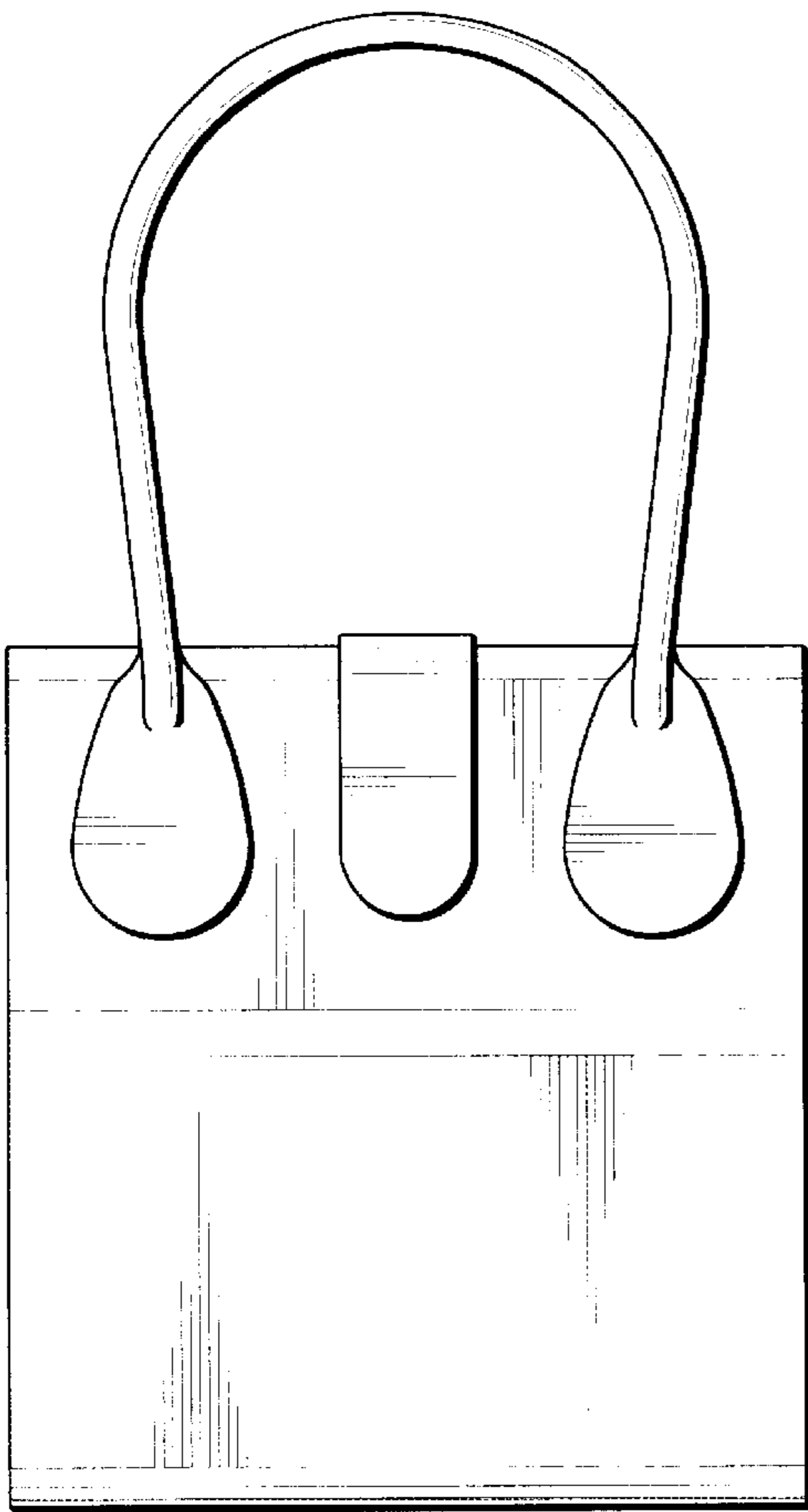

FIG. 5

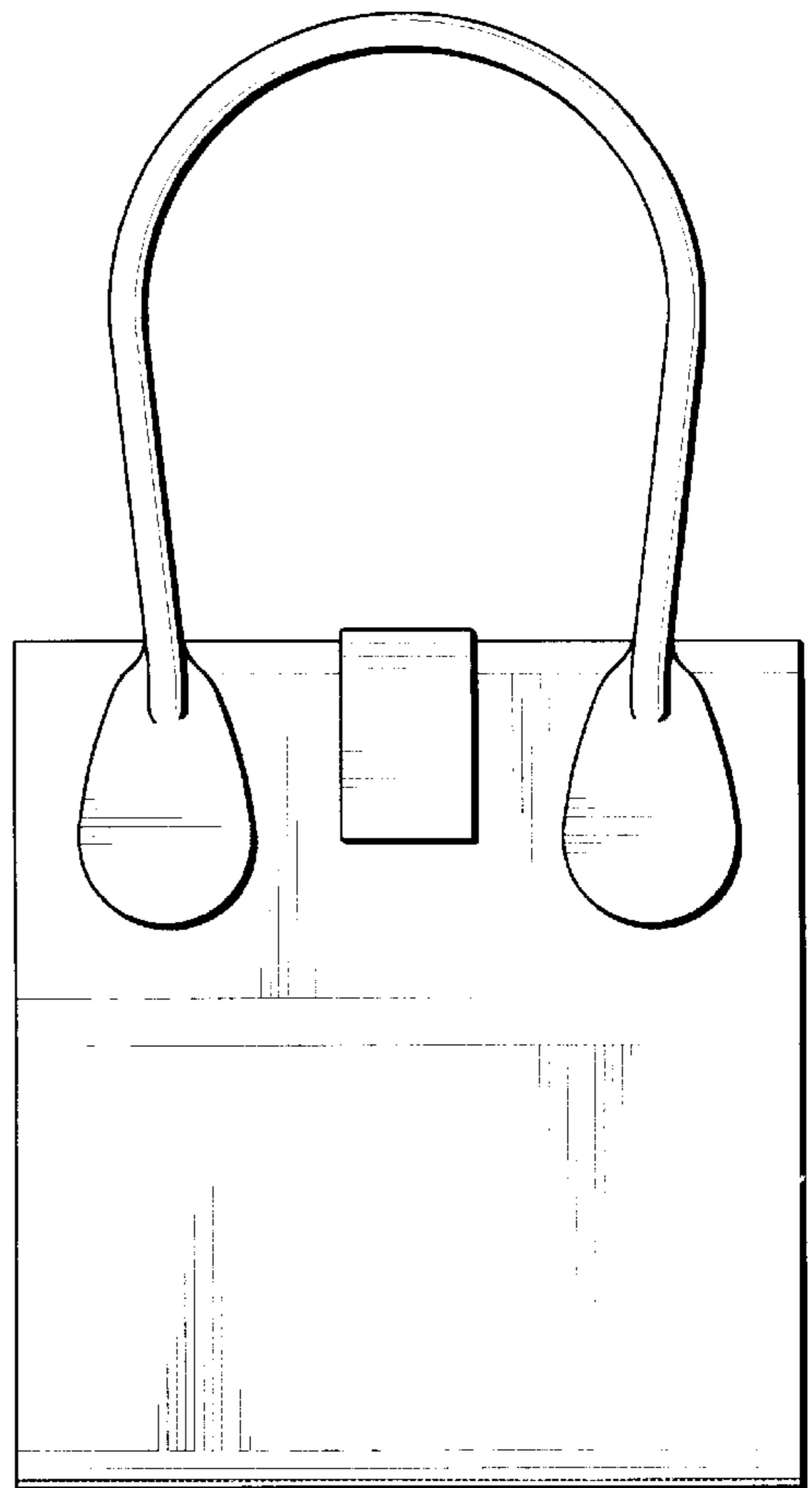

FIG. 6