



US00D480158S

(12) **United States Design Patent**
Ludwig

(10) **Patent No.:** **US D480,158 S**

(45) **Date of Patent:** **** Sep. 30, 2003**

(54) **MULTIPURPOSE ORNAMENTAL POST**

DESCRIPTION

(75) Inventor: **Jon Ludwig**, New Berlin, WI (US)

(73) Assignee: **ICM Corporation**, Milwaukee, WI (US)

(**) Term: **14 Years**

(21) Appl. No.: **29/170,444**

(22) Filed: **Nov. 6, 2002**

(51) **LOC (7) Cl.** **25-01**

(52) **U.S. Cl.** **D25/126**

(58) **Field of Search** D25/126; 52/720.1,
52/736.1; 362/382, 410, 431

(56) **References Cited**

U.S. PATENT DOCUMENTS

D430,681 S * 9/2000 Miranda D25/126

* cited by examiner

Primary Examiner—Doris Clark

(74) *Attorney, Agent, or Firm*—Jon Carl Gealow

(57) **CLAIM**

The ornamental design for a multipurpose ornamental post, as shown and described.

FIG. 1 is a front perspective view of a multipurpose ornamental post with a globe mounted on the top thereof, showing my new design;
FIG. 2 is a top elevation view thereof;
FIG. 3 is a front elevation view thereof;
FIG. 4 is a right side elevation view thereof;
FIG. 5 is a left side elevation view thereof;
FIG. 6 is a front perspective view of a second embodiment of a multipurpose ornamental post with a cylindrical shaped object mounted on the top thereof; showing my new design;
FIG. 7 is a front elevation view thereof;
FIG. 8 is a top elevation view thereof;
FIG. 9 is a front perspective view of a third embodiment of a multipurpose ornamental post with a lantern shaped object mounted on the top thereof; showing my new design;
FIG. 10 is a front elevation view thereof;
FIG. 11 is a top elevation view thereof;
FIG. 12 is a front perspective view of a fourth embodiment of a multipurpose ornamental post with a rectangular shaped object mounted on the top thereof; showing my new design;
FIG. 13 is a front elevation view thereof;
FIG. 14 is a top elevation view thereof;
FIG. 15 is a left side elevation view thereof; and,
FIG. 16 is a right side elevation view thereof.
The broken lines are for illustrative purposes only, and form no part of the claimed design.

1 Claim, 10 Drawing Sheets

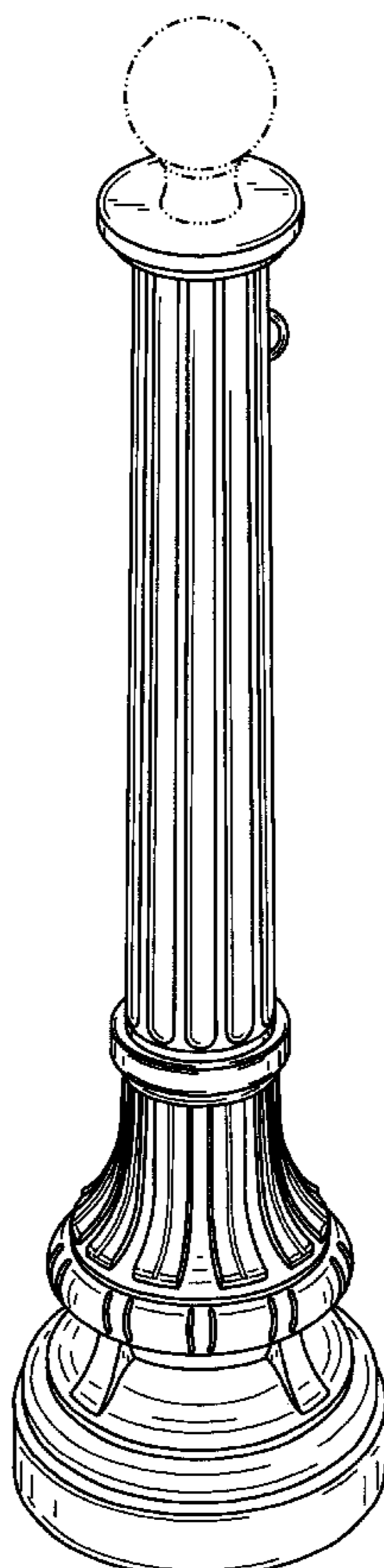

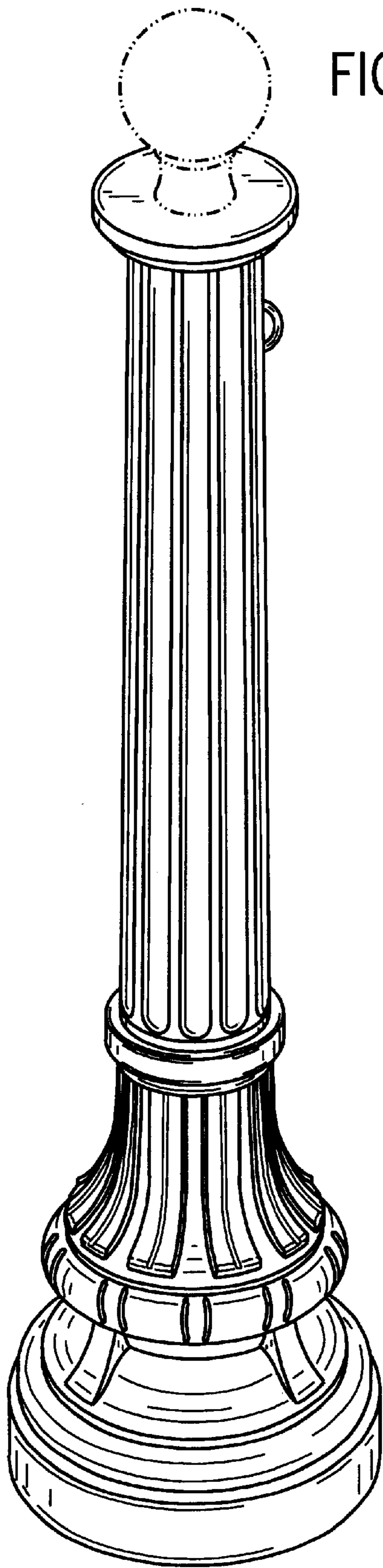

FIG. 1

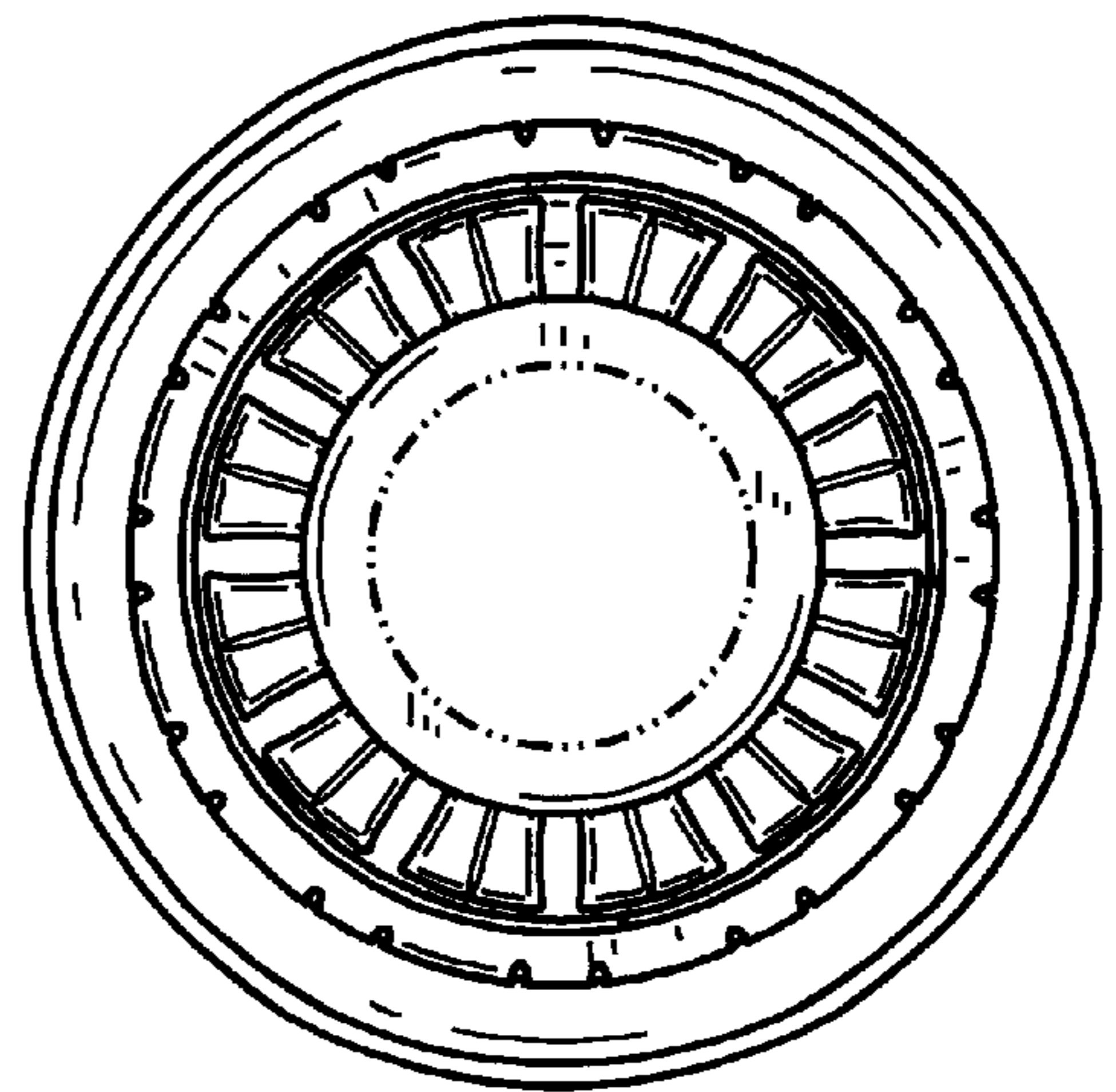
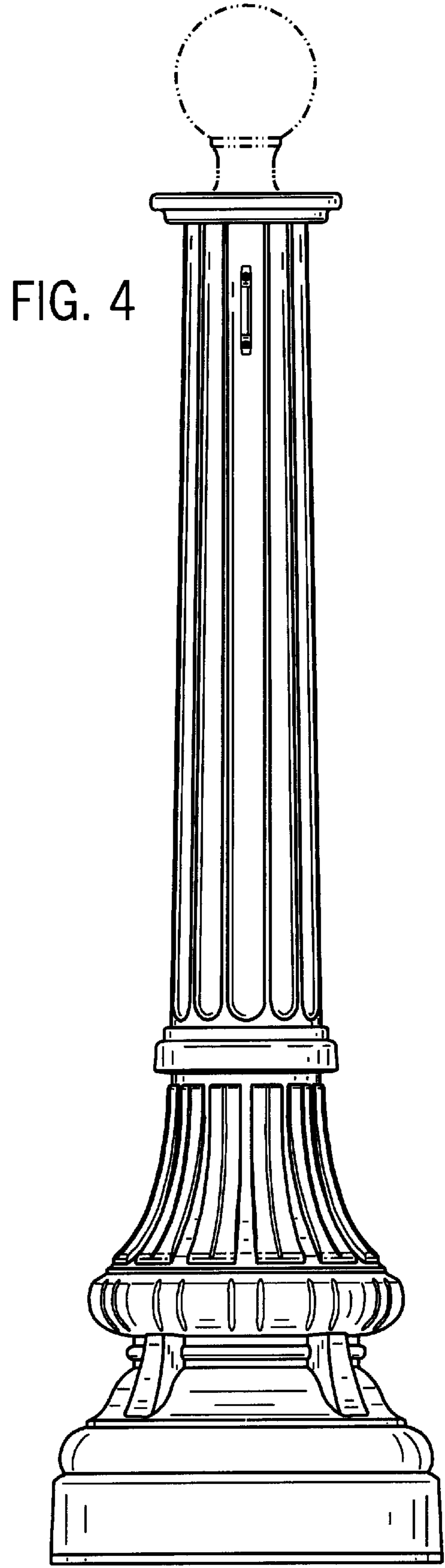
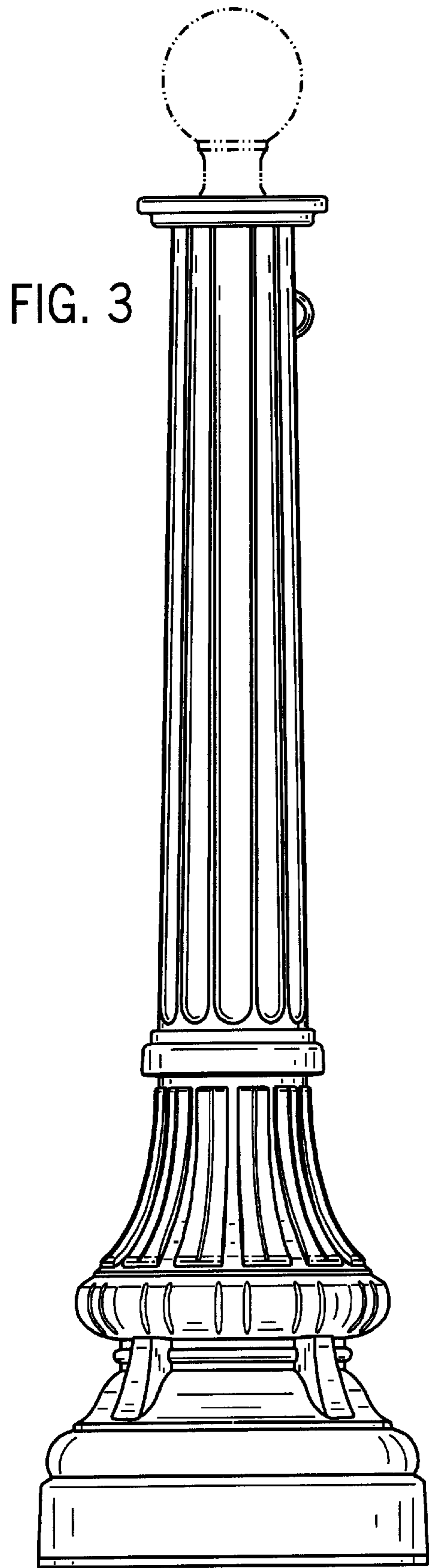

FIG. 2



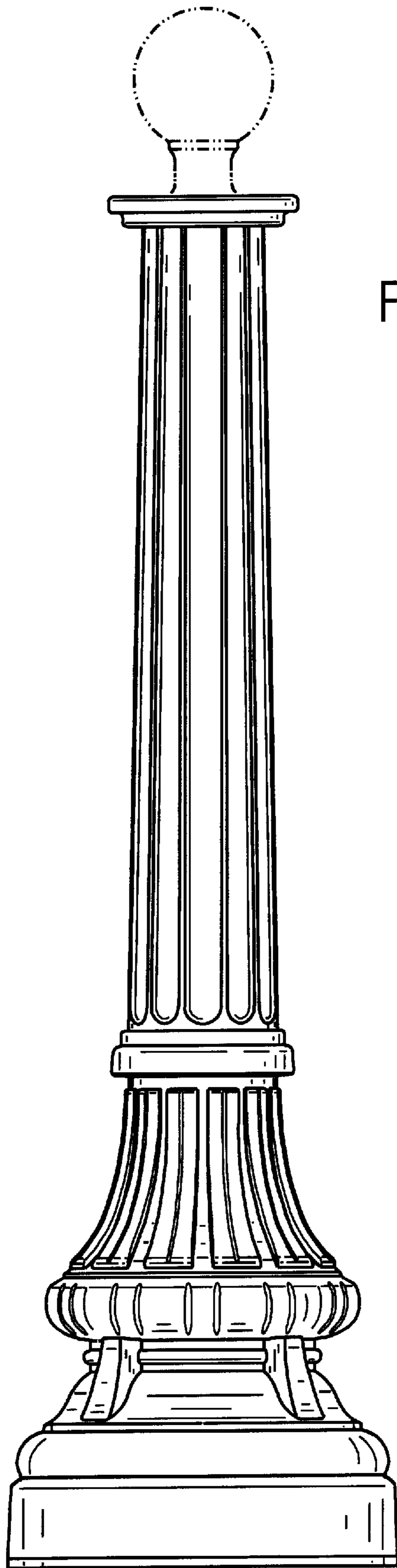

FIG. 5

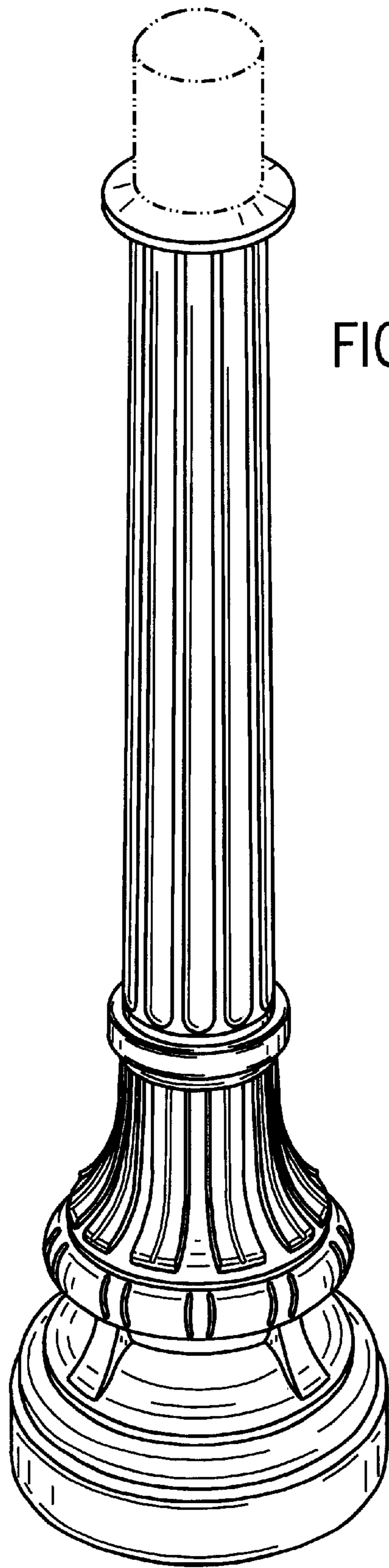

FIG. 6

FIG. 7

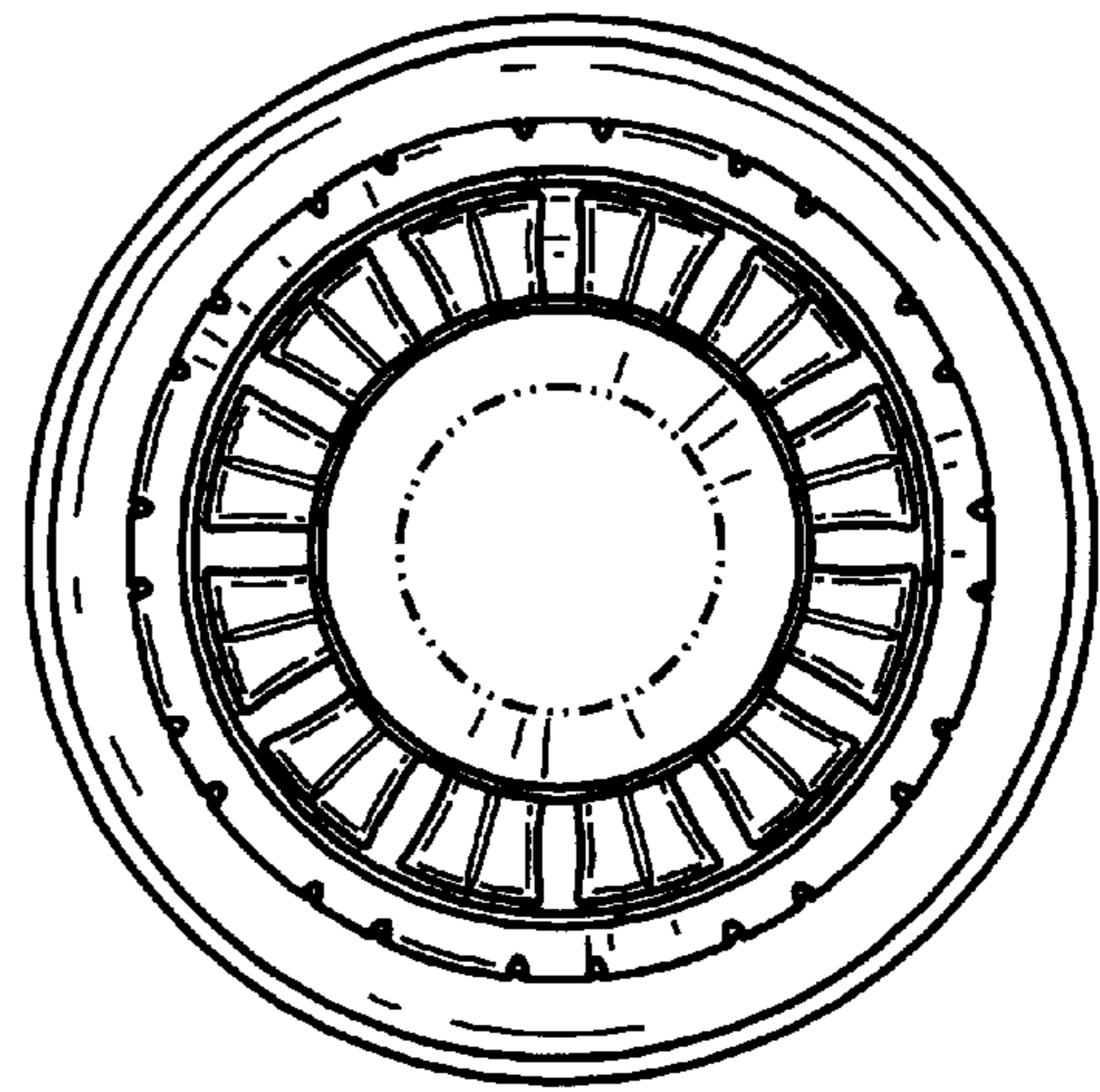
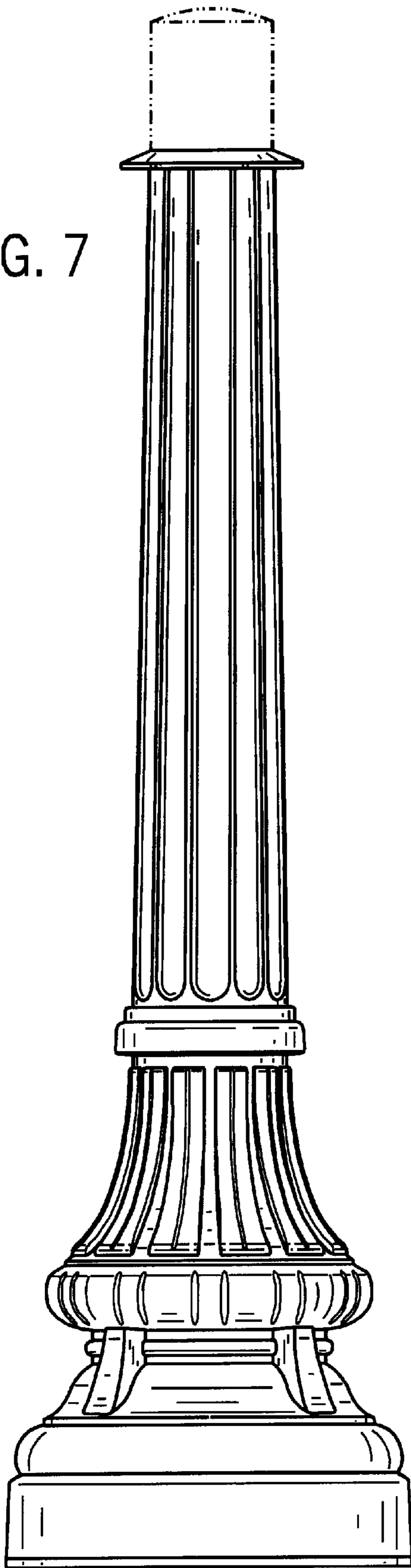

FIG. 8

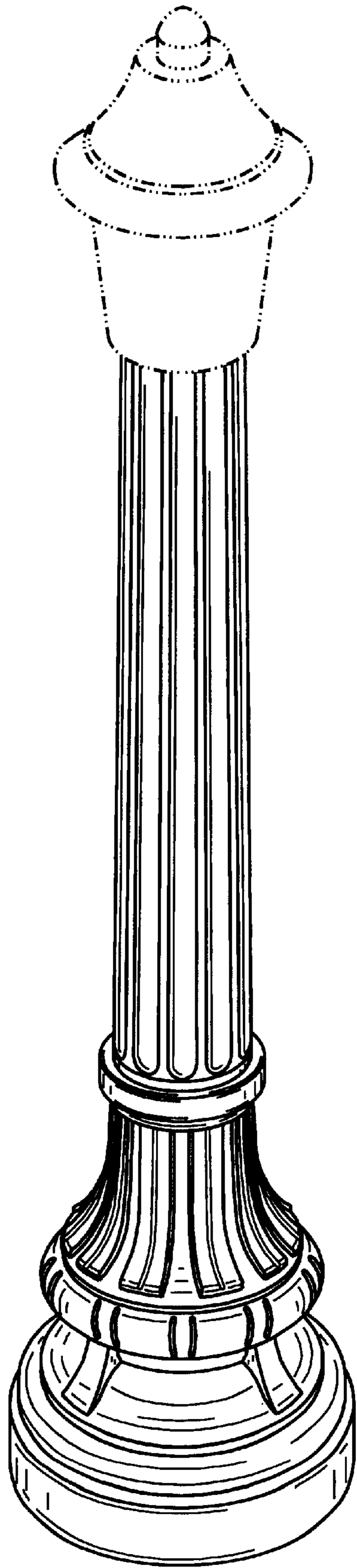

FIG. 9

FIG. 10

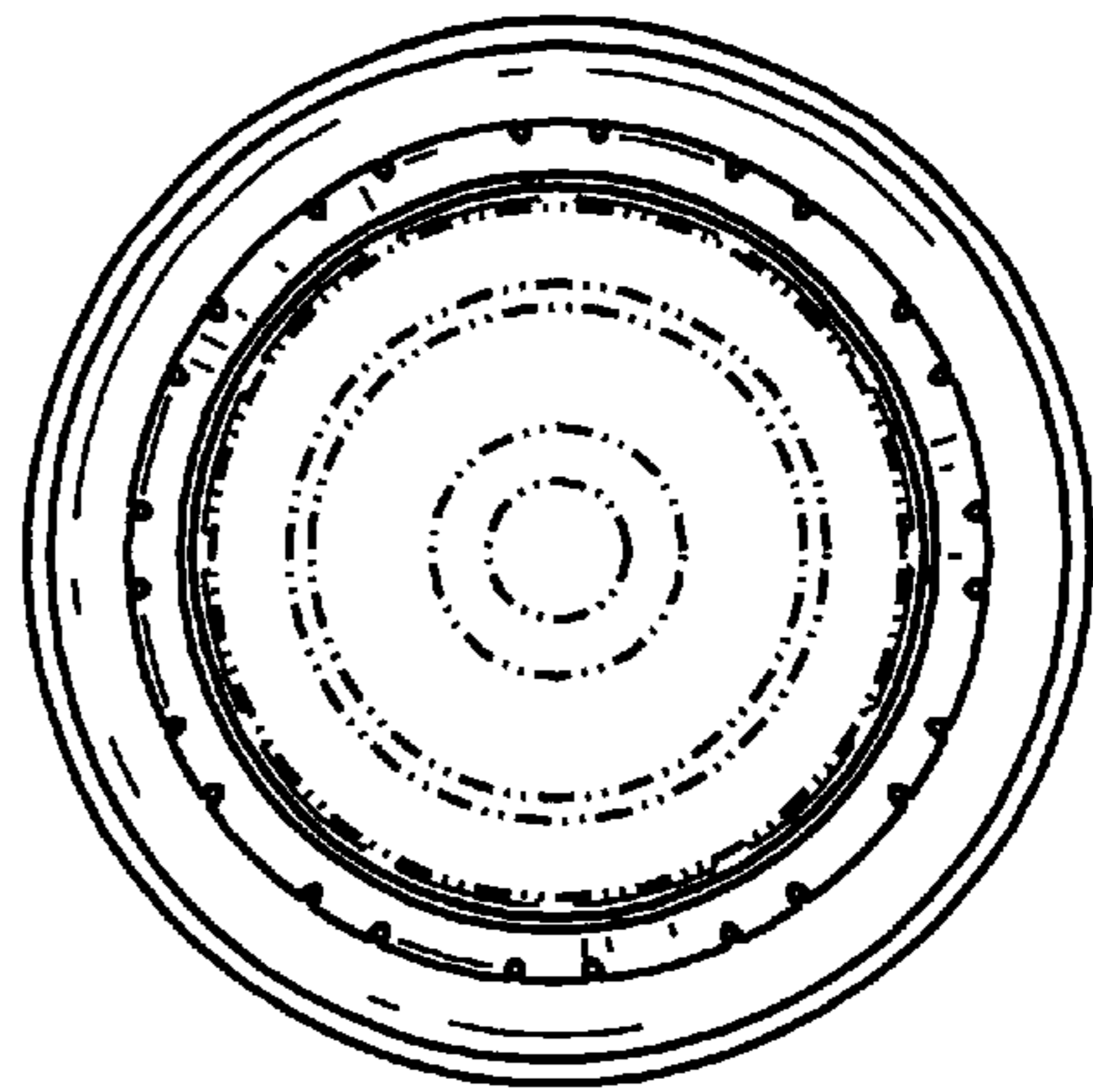
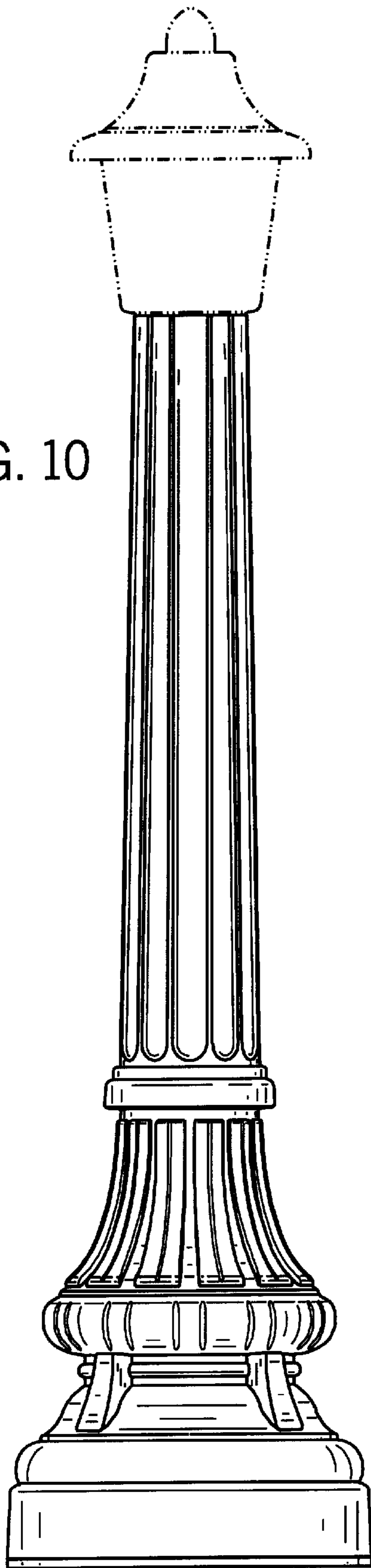

FIG. 11

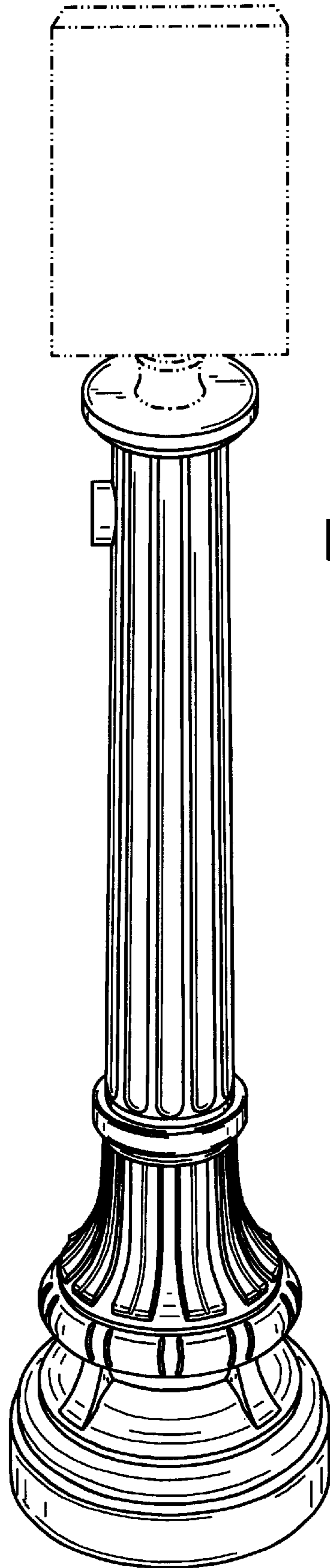

FIG. 12

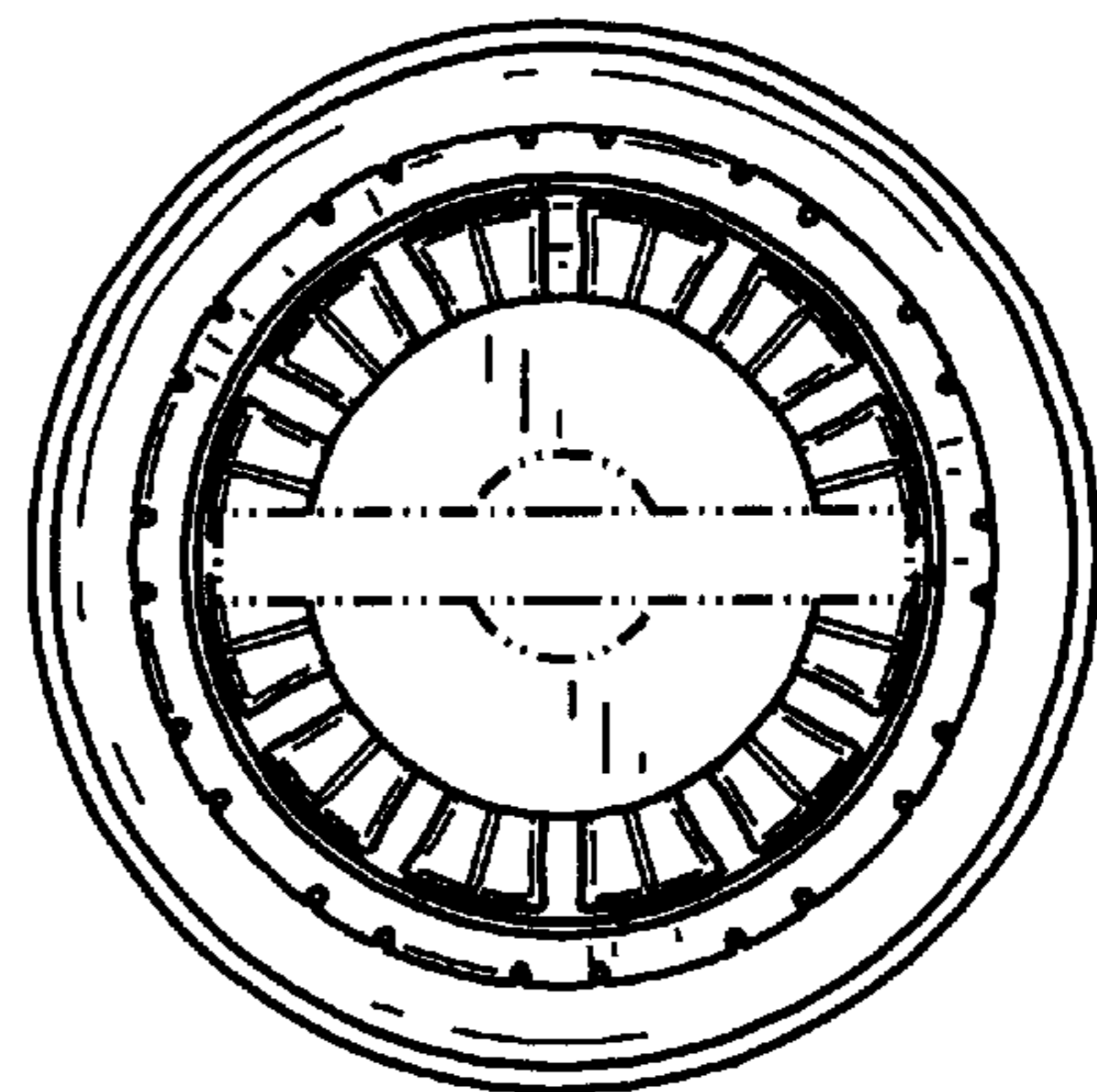
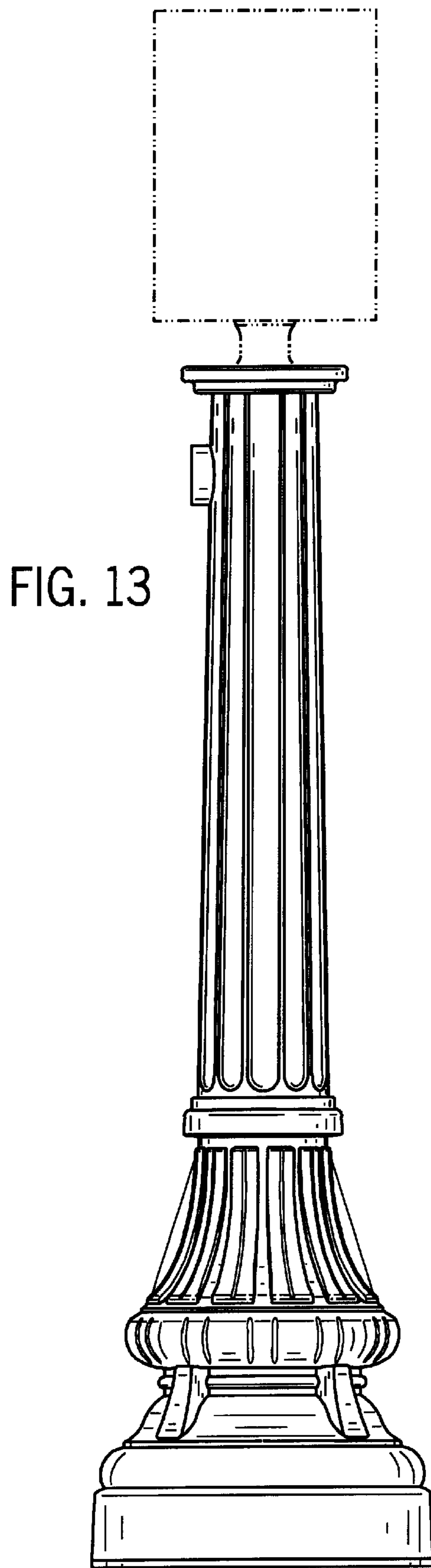

FIG. 15

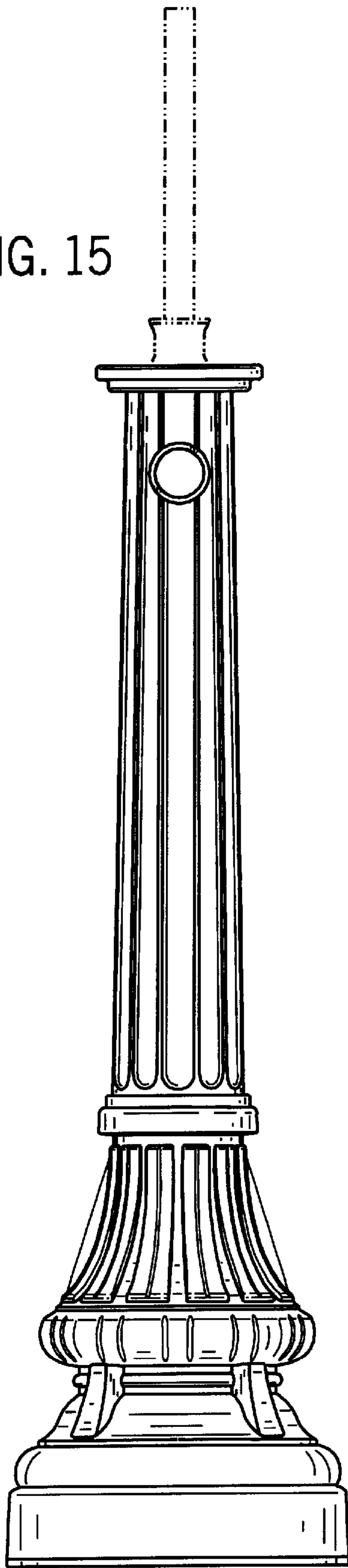

FIG. 16

