



US00D480143S

(12) **United States Design Patent**  
**Kondo**

(10) **Patent No.:** **US D480,143 S**

(45) **Date of Patent:** **\*\* Sep. 30, 2003**

(54) **IMAGE RECORDING MACHINE FOR MEDICAL TREATMENT**

D340,520 S \* 10/1993 Reibl ..... D24/158  
D372,095 S \* 7/1996 Whitby et al. .... D24/158  
D408,838 S \* 4/1999 Nelson et al. .... D16/247

(75) Inventor: **Shozo Kondo**, Tokyo (JP)

\* cited by examiner

(73) Assignee: **Fuji Photo Film Co., Ltd.**, Kanagawa (JP)

*Primary Examiner*—Stella Reid

(74) *Attorney, Agent, or Firm*—Young & Thompson

(\*\*) Term: **14 Years**

(57) **CLAIM**

(21) Appl. No.: **29/169,421**

The ornamental design for an image recording machine for medical treatment, as shown and described.

(22) Filed: **Oct. 21, 2002**

**DESCRIPTION**

(30) **Foreign Application Priority Data**

Jun. 18, 2002 (JP) ..... 2002-016337

(51) **LOC (7) Cl.** ..... **24-01**

(52) **U.S. Cl.** ..... **D24/158**

(58) **Field of Search** ..... D24/158; 378/167, 378/171, 173, 175, 176; D16/247

FIG. 1 is a top, front and side perspective view of an image recording machine for medical treatment, showing my new design;

FIG. 2 is a front elevational view thereof;

FIG. 3 is a rear elevational view thereof;

FIG. 4 is a top plan view thereof;

FIG. 5 is a bottom plan view thereof;

FIG. 6 is a side elevational view thereof from the right of FIG. 2;

FIG. 7 is a side elevational view thereof from the left of FIG. 2; and,

FIG. 8 is a second embodiment of the image recording machine for medical treatment shown in FIG. 1, with the only difference residing in the configuration of the front view.

(56) **References Cited**

**U.S. PATENT DOCUMENTS**

3,916,206 A \* 10/1975 Koch et al. .... 378/173  
3,965,361 A \* 6/1976 Reser ..... 271/248  
4,201,919 A \* 5/1980 Schmidt ..... 53/284.4  
D272,744 S \* 2/1984 Schlagheck et al. .... D16/247  
D273,872 S \* 5/1984 Schlagheck et al. .... D16/247  
D312,690 S \* 12/1990 Reibl ..... D16/247  
D318,479 S \* 7/1991 Nishiseko et al. .... D16/246

**1 Claim, 4 Drawing Sheets**

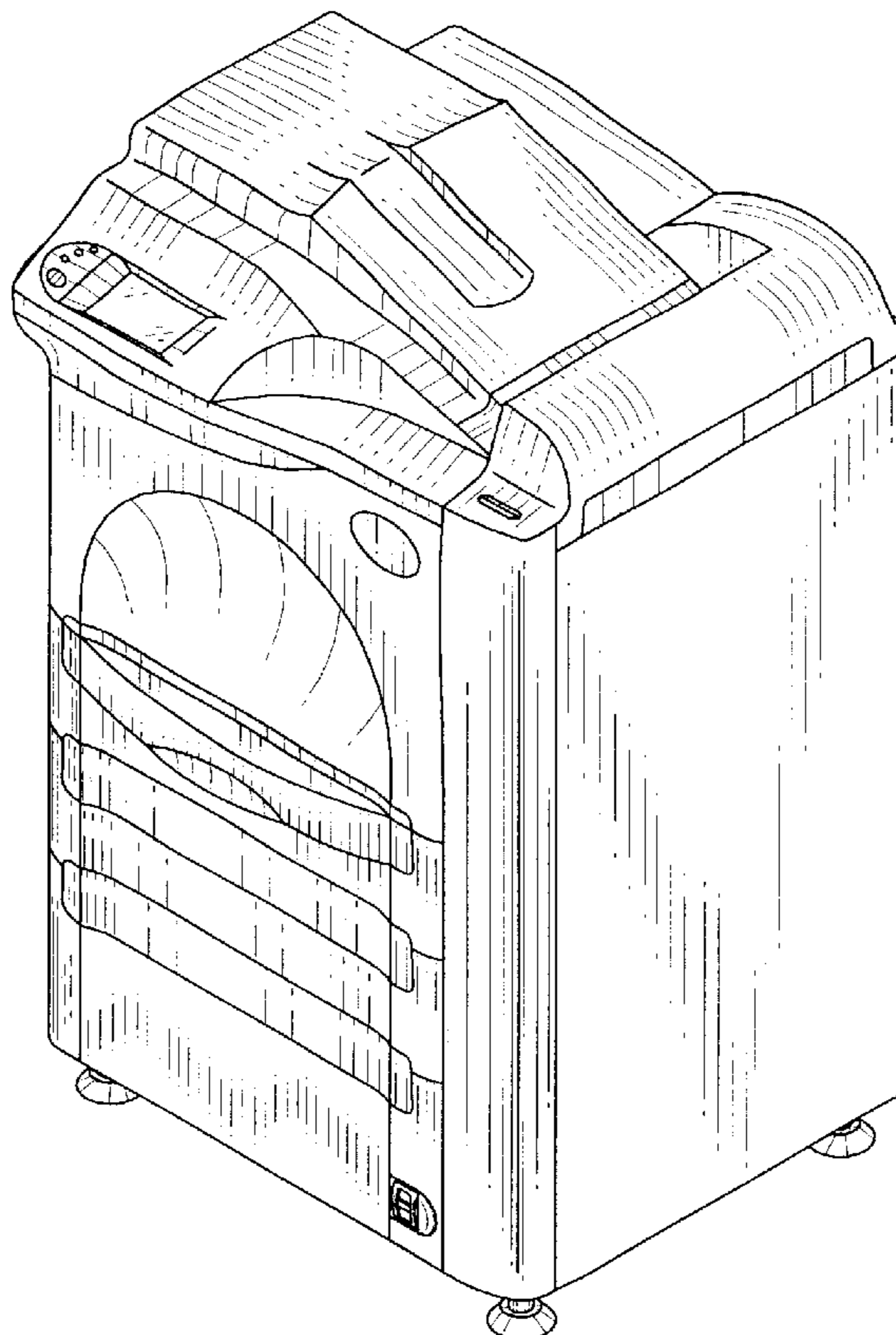

Fig. 1

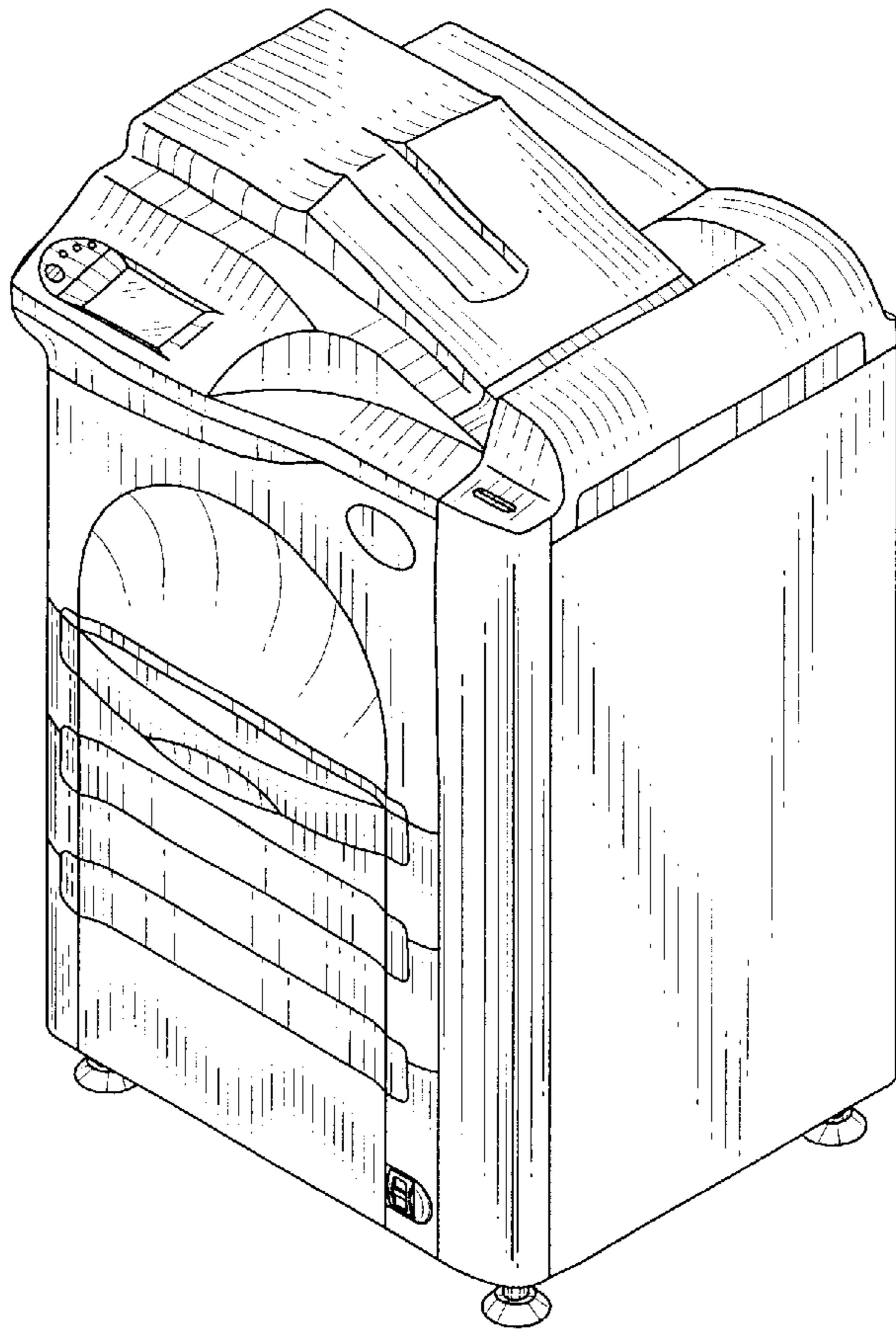

Fig. 2

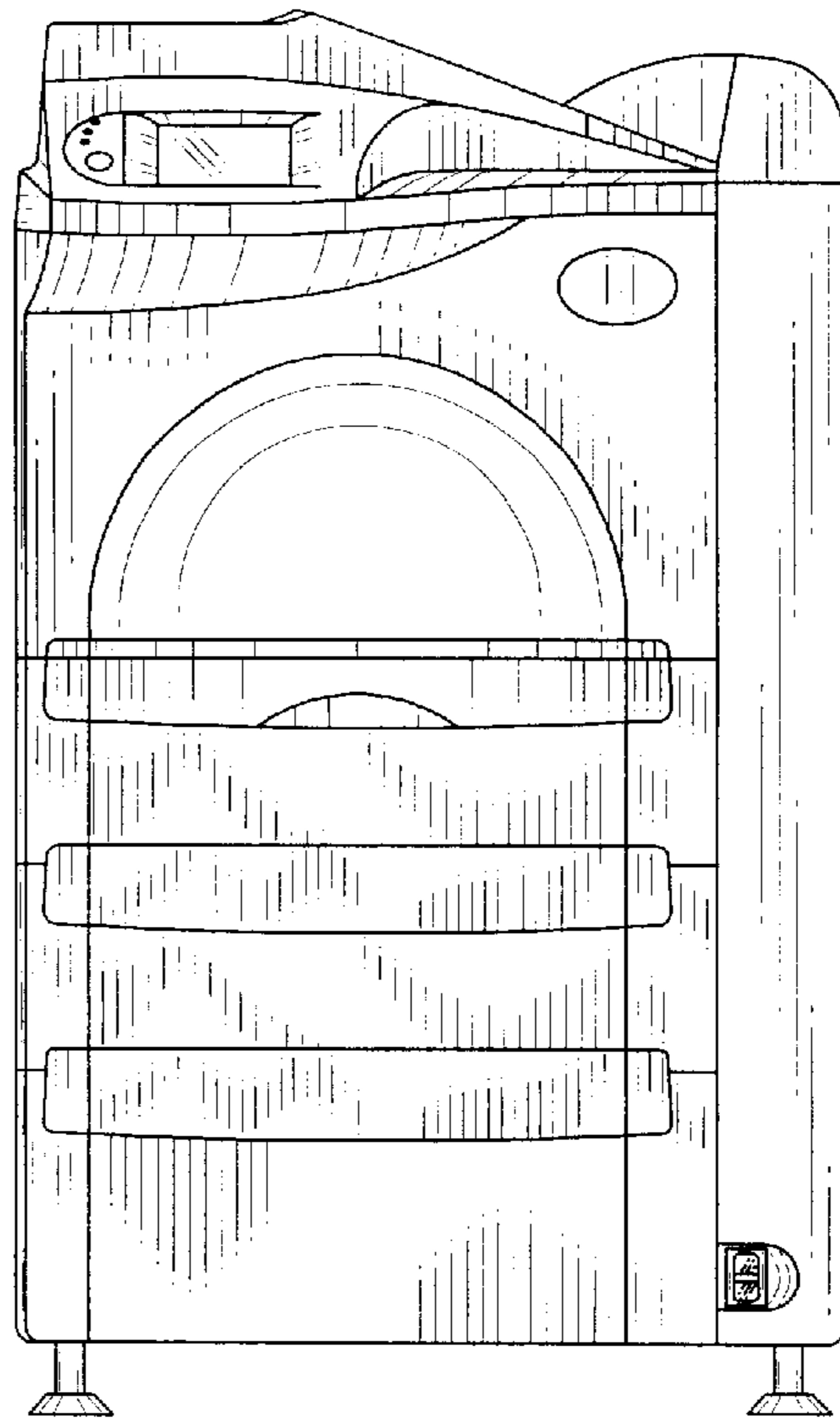

Fig. 3

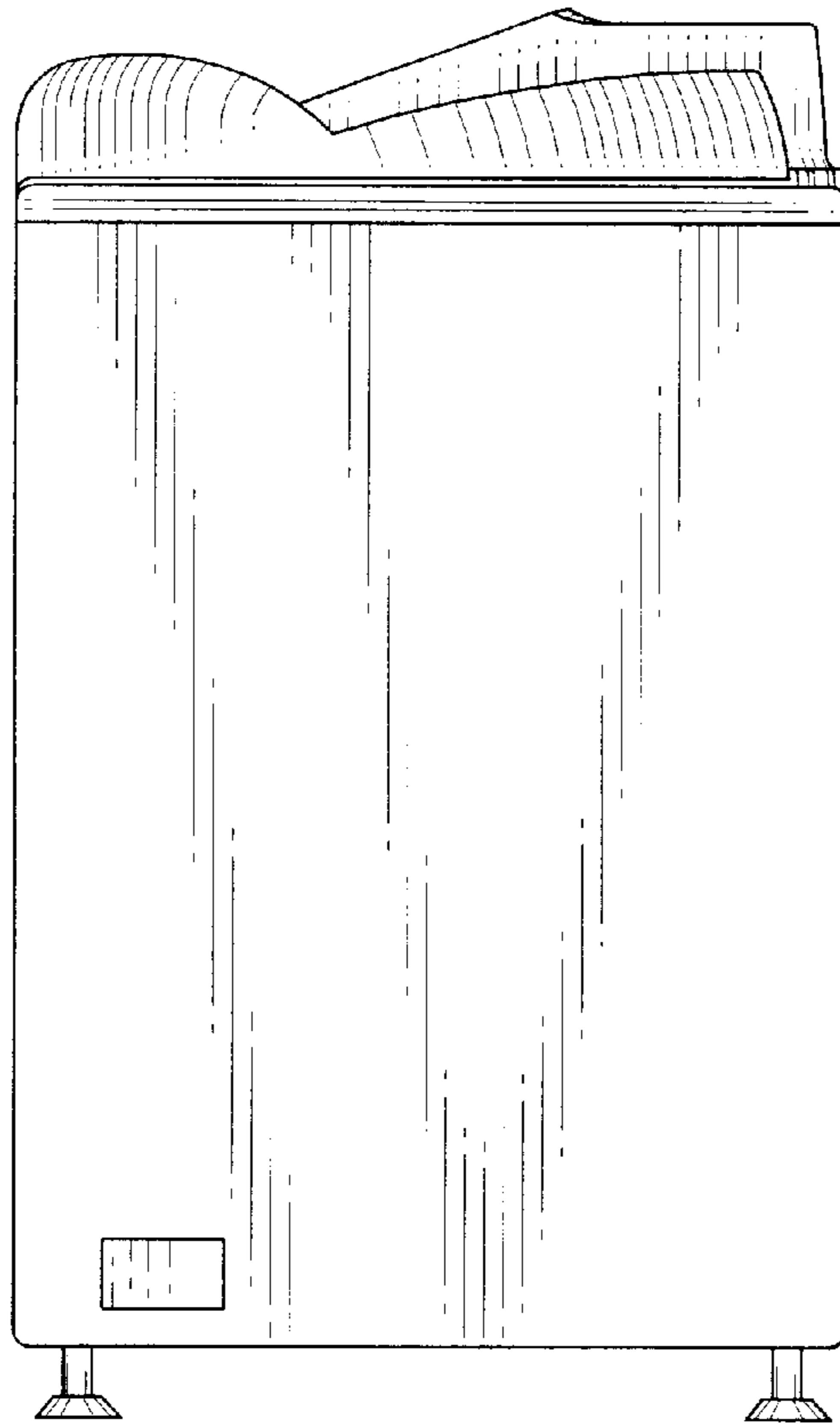

Fig. 4

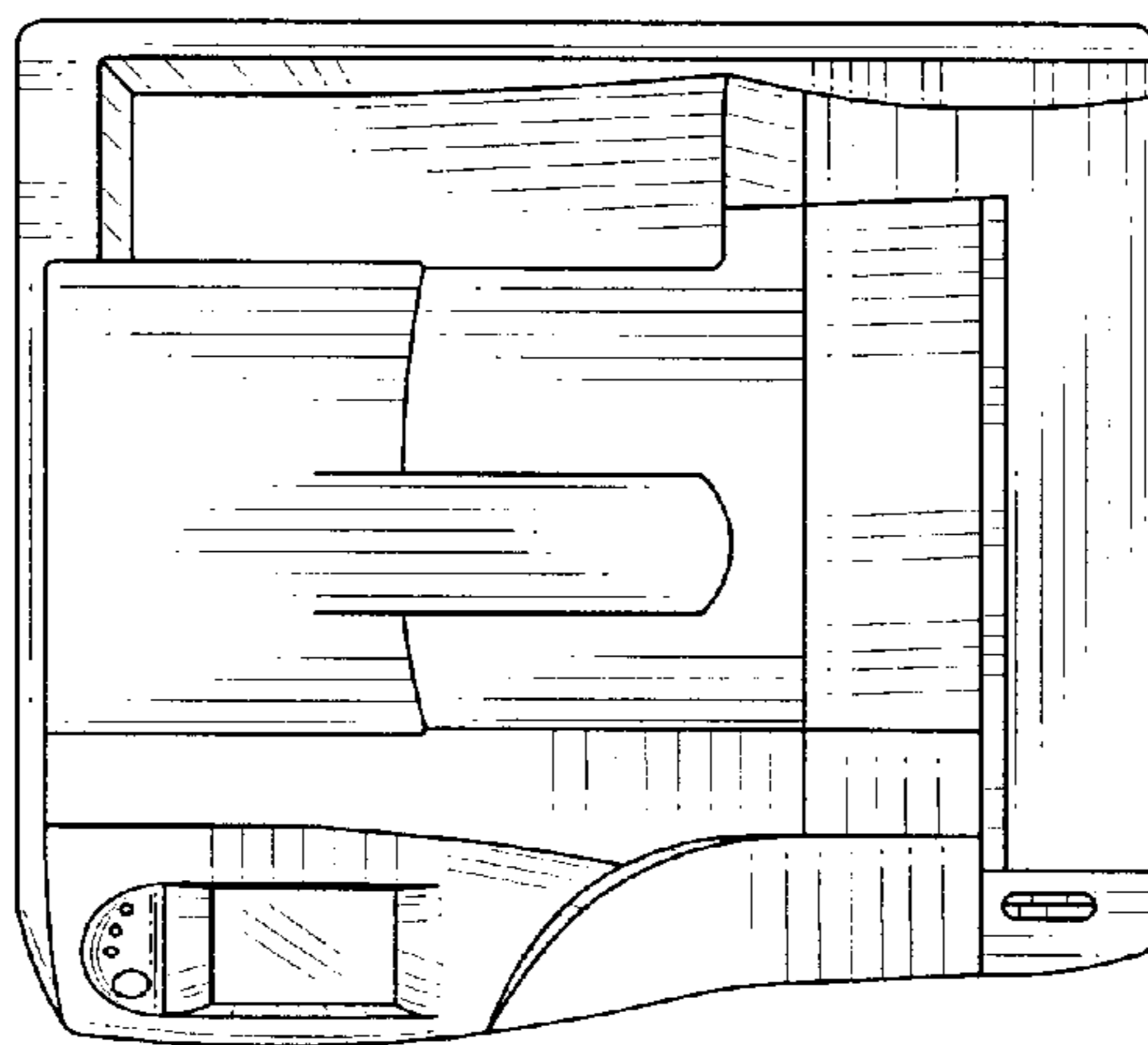

Fig. 5

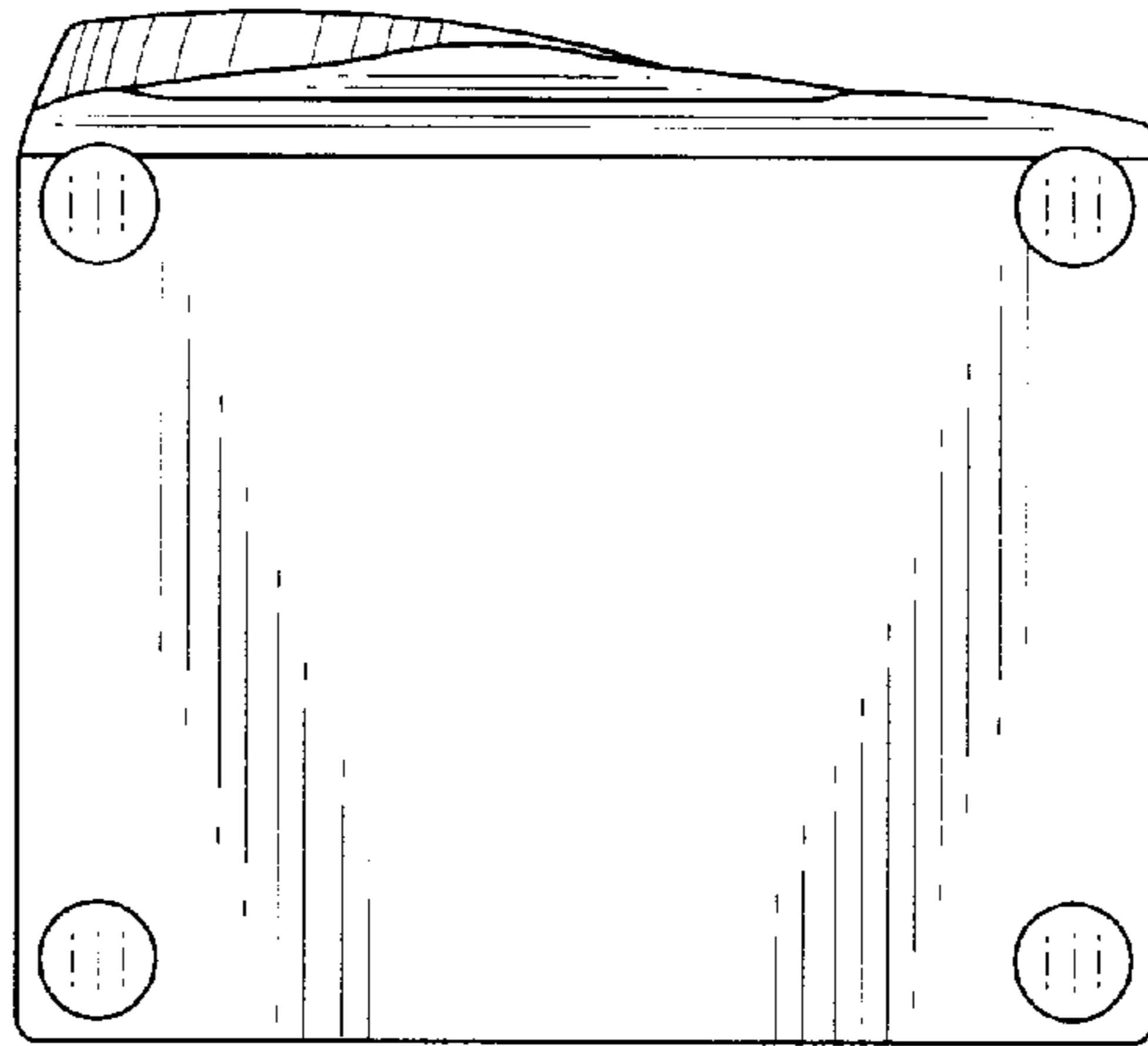

Fig. 6

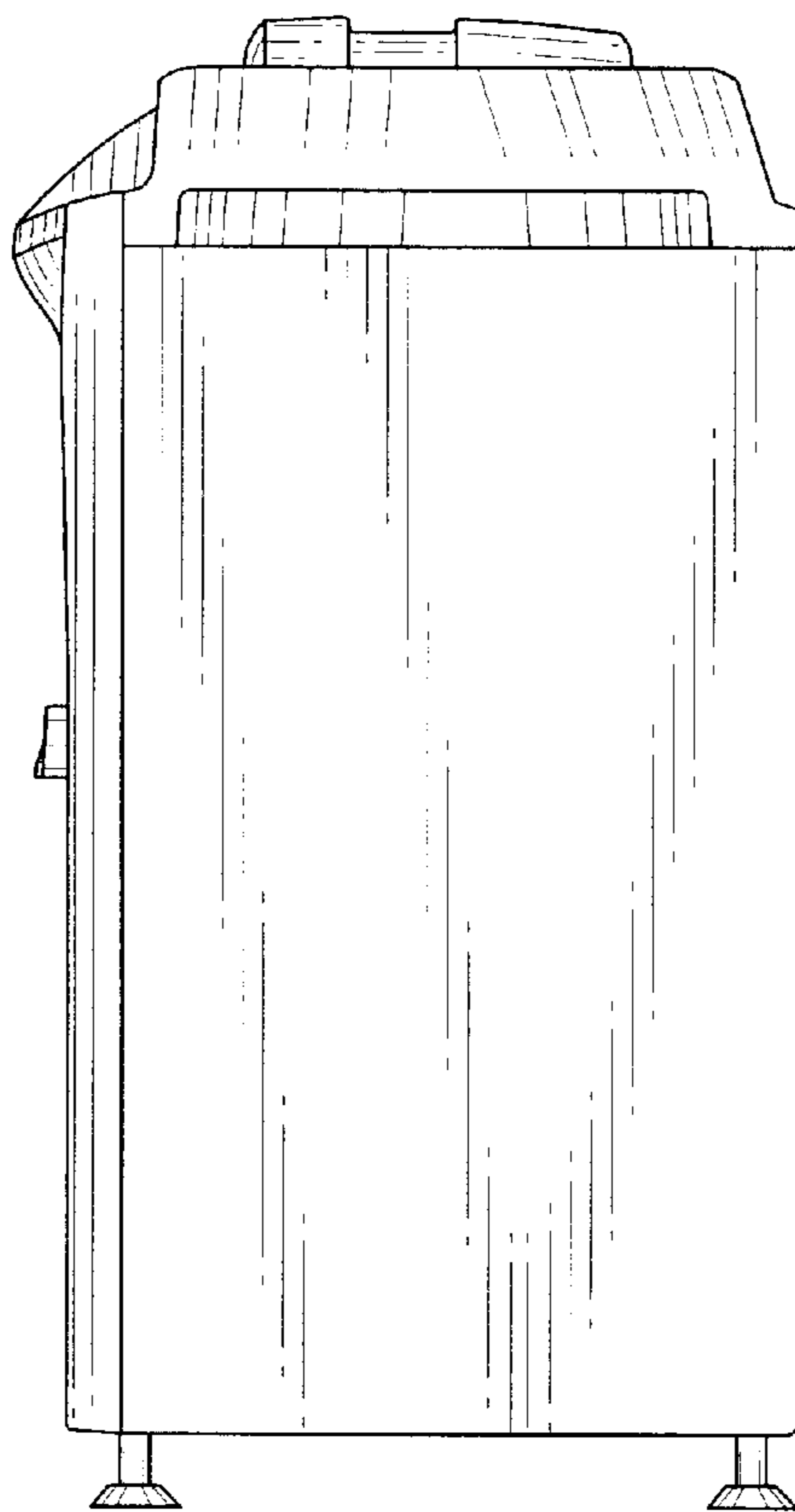

Fig. 7

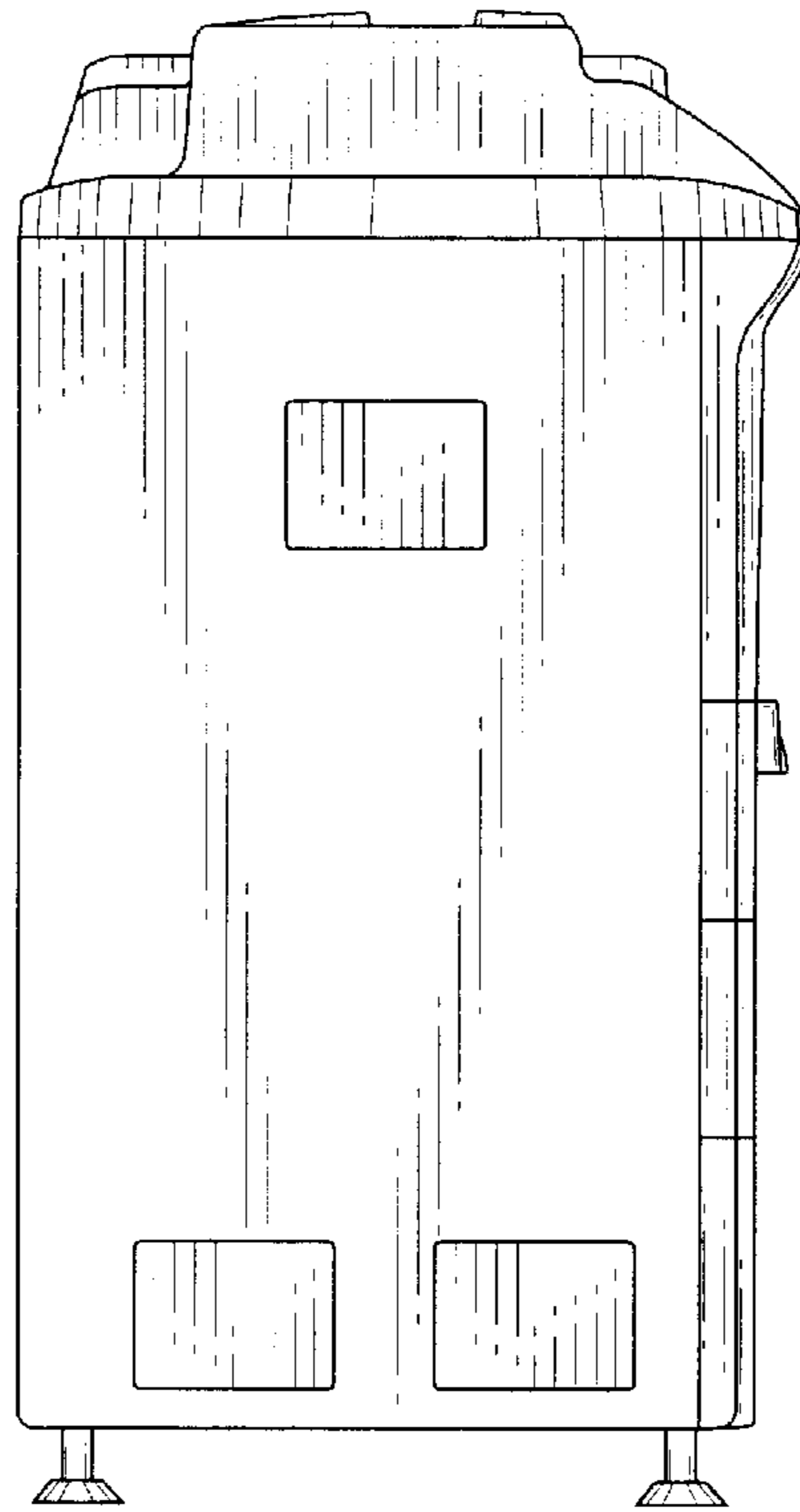

Fig. 8

